

9. oktober 2018

204 HF

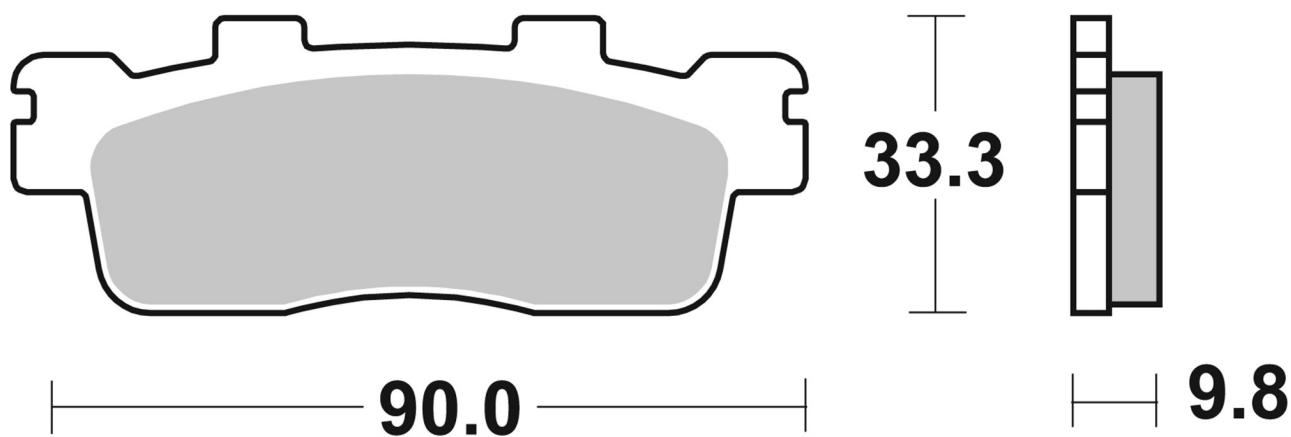

SBS ref. #	Available compounds
204 HF	CT • HF • MS



RECOMMENDED

