

12. oktober 2018

# 146 Hf

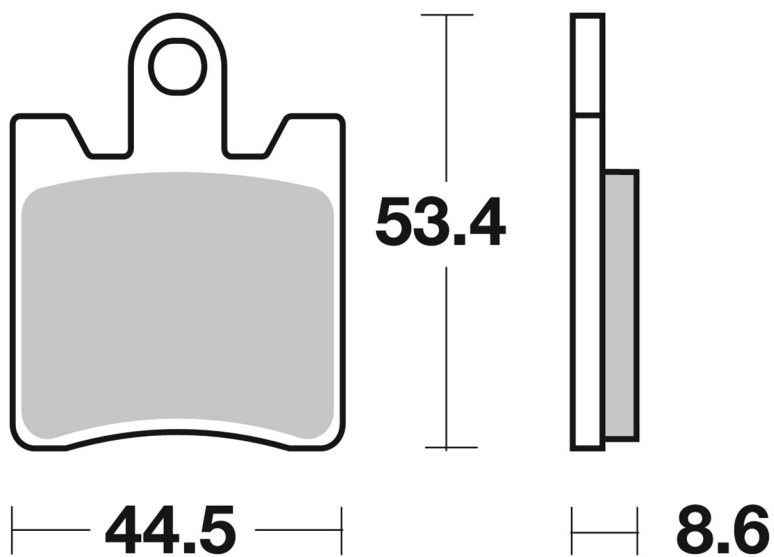

SBS ref. #	Available compounds
146 Hf	CT • HF • MS



**RECOMMENDED**

