



## STYLING

---

SPECCHI RETROVISORI  
STABILIZZATORI  
MANOPOLE  
PORTATARGA  
DECORAZIONI



12 REAR VIEW MIRRORS  
22 BAR ENDS  
24 GRIPS  
25 PLATE HOLDERS  
29 DECORATIONS

# Specchi retrovisori rearview mirrors



**CLASSIC, COPPIA SPECCHI MOTO**

- Snodo regolabile.
- Attacco a manubrio.
- Filettatura destra M10x1,25.
- Omologati.

**CLASSIC, PAIR OF REARVIEW MIRRORS**

- Adjustable.
- Handlebar fitting.
- Right thread M10x1,25.
- Approved.

**90490**

Scatola / Box 5 / 30



Classic

**2**  
pcs

**SX** + **DX**

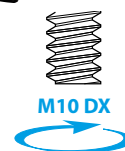

**MARPH, COPPIA SPECCHI MOTO**

- Snodo regolabile.
- Attacco a manubrio.
- Filettatura destra M10x1,25.
- Omologati.

**MARPH, PAIR OF REARVIEW MIRRORS**

- Adjustable.
- Handlebar fitting.
- Right thread M10x1,25.
- Approved.

**90487**

Scatola / Box 5 / 30



Snodo regolabile  
Adjustable mirrors



Marph

2  
pcs

SX + DX

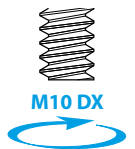

**JAX, COPPIA SPECCHI MOTO**

- Snodo regolabile.
- Attacco a manubrio.
- Filettatura destra M10x1,25.
- Omologati.

**JAX, PAIR OF REARVIEW MIRRORS**

- Adjustable.
- Handlebar fitting.
- Right thread M10x1,25.
- Approved.

**90488**

Scatola / Box 5 / 30

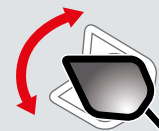

Snodo regolabile  
Adjustable mirrors



Jax

2  
pcs

SX + DX

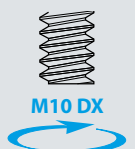

Inclinazione  
regolabile  
Adjustable  
angle

Inclinazione  
regolabile  
Adjustable  
angle

**FENDER, COPPIA SPECCHI MOTO**

- Snodo regolabile.
- Attacco a manubrio.
- Filettatura destra M10x1,25.
- Omologati.

**FENDER, PAIR OF REARVIEW MIRRORS**

- Adjustable.
- Handlebar fitting.
- Right thread M10x1,25.
- Approved.

**90489**

Scatola / Box 5 / 30



Snodo regolabile  
Adjustable mirrors



Fender

**2**  
pcs

**SX** + **DX**

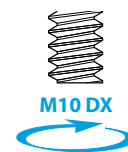

**BORG, COPPIA SPECCHI MOTO**

- Snodo regolabile.
- Attacco a manubrio.
- Filettatura destra M10x1,25.
- Omologati.

**BORG, PAIR OF REARVIEW MIRRORS**

- Adjustable.
- Handlebar fitting.
- Right thread M10x1,25.
- Approved.

**90486**

Scatola / Box 5 / 30

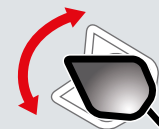

Snodo regolabile  
Adjustable mirrors



Borg

**2**  
pcs

**SX** + **DX**

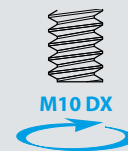

**SPACE, COPPIA SPECCHI MOTO**

- Snodo regolabile.
- Attacco a manubrio.
- Filettatura destra M10x1,25.
- Omologati.

**SPACE, PAIR OF REARVIEW MIRRORS**

- Adjustable.
- Handlebar fitting.
- Right thread M10x1,25.
- Approved.

**90080**

Scatola / Box 5 / 30



Space

2 pcs  
SX + DX



Snodo regolabile  
Adjustable mirrors

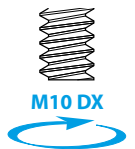

M10 DX



**LIMITS, COPPIA SPECCHI MOTO**

- Snodo regolabile.
- Attacco a manubrio.
- Filettatura destra M10x1,25.
- Omologati.

**LIMITS, PAIR OF REARVIEW MIRRORS**

- Adjustable.
- Handlebar fitting.
- Right thread M10x1,25.
- Approved.

**90081**

Scatola / Box 5 / 30



Limits

2 pcs  
SX + DX



Snodo regolabile  
Adjustable mirrors

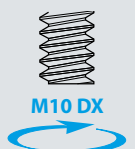

M10 DX



**KABA, COPPIA SPECCHI MOTO**

- Snodo regolabile.
- Attacco a manubrio.
- Filettatura destra M10x1,25.
- Omologati.

**KABA, PAIR OF REARVIEW MIRRORS**

- Adjustable.
- Handlebar fitting.
- Right thread M10x1,25.
- Approved.

**90346**

Scatola / Box 5 / 30



Snodo regolabile  
Adjustable mirrors

Kaba

**2**  
pcs

**SX** + **DX**

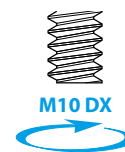

**DIKE, COPPIA SPECCHI MOTO**

- Snodo regolabile.
- Attacco a manubrio.
- Filettatura destra M10x1,25.
- Omologati.

**DIKE, PAIR OF REARVIEW MIRRORS**

- Adjustable.
- Handlebar fitting.
- Right thread M10x1,25.
- Approved.

**90347**

Scatola / Box 5 / 30



Snodo regolabile  
Adjustable mirrors

Dike

**2**  
pcs

**SX** + **DX**

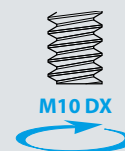

**TORI, COPPIA SPECCHI MOTO**

- Snodo regolabile.
- Attacco a manubrio.
- Filettatura destra M8x1,25.
- Omologati.

**TORI, PAIR OF REARVIEW MIRRORS**

- Adjustable.
- Handlebar fitting.
- Right thread M8x1,25.
- Approved.

**90344**

Scatola / Box 5 / 30



Tori

2 pcs

SX + DX

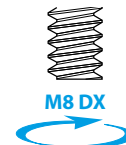

**VINK, COPPIA SPECCHI MOTO**

- Snodo regolabile.
- Attacco a manubrio.
- Filettatura destra M10x1,25.
- Omologati.

**VINK, PAIR OF REARVIEW MIRRORS**

- Adjustable.
- Handlebar fitting.
- Right thread M10x1,25.
- Approved.

**90345**

Scatola / Box 5 / 30



Vink

2 pcs

SX + DX

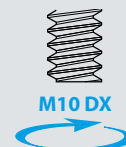

**KIRO, COPPIA SPECCHI MOTO**

- Snodo regolabile.
- Attacco a manubrio.
- Filettatura destra M10x1,25.
- Omologati.

**KIRO, PAIR OF REARVIEW MIRRORS**

- Adjustable.
- Handlebar fitting.
- Right thread M10x1,25.
- Approved.

**90430**

Scatola / Box 5 / 30



**2**  
pcs

**SX** + **DX**

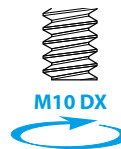

Kiro

**HORIZON EVO, COPPIA SPECCHI MOTO**

- Snodo regolabile.
- Attacco a manubrio.
- Filettatura destra M10x1,25.
- Omologati.

**HORIZON EVO, PAIR OF REARVIEW MIRRORS**

- Adjustable.
- Handlebar fitting.
- Right thread M10x1,25.
- Approved.

**90431**

Scatola / Box 5 / 30



**2**  
pcs

**SX** + **DX**

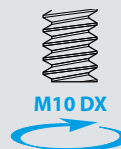

Horizon EVO



**TRAX, COPPIA SPECCHI MOTO**

- Snodo regolabile.
- Attacco a manubrio.
- Filettatura destra M10x1,25.
- Omologati.

**TRAX, PAIR OF REARVIEW MIRRORS**

- Adjustable.
- Handlebar fitting.
- Right thread M10x1,25.
- Approved.

**90432**

Scatola / Box 5 / 30



**INFINITY, COPPIA SPECCHI MOTO**

- Snodo regolabile
- Braccio in lega leggera
- Attacco a manubrio
- Filettatura destra M10x1,25.
- Omologati

**INFINITY, PAIR OF REARVIEW MIRRORS**

- Adjustable
- Aluminium alloy material
- Handlebar fitting
- Right thread M10x1,25.
- Approved

**90129**

Scatola / Box 5 / 30



**HORIZON, COPPIA SPECCHI MOTO**

- Snodo regolabile
- Attacco a manubrio
- Filettatura destra M8x1,25
- Omologati

**HORIZON, PAIR OF REARVIEW MIRRORS**

- Adjustable
- Handlebar fitting
- Right thread M8x1,25
- Approved

**90128**

Scatola / Box 5 / 30



Horizon

**2**  
pcs

**SX** + **DX**

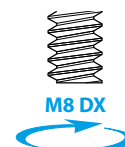

Dernier

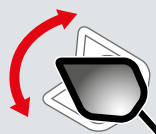

Snodo regolabile  
Adjustable mirrors

**DERNIER, COPPIA SPECCHI MOTO PER MANUBRIO**

- Snodo regolabile
- Attacco a manubrio
- 13-18mm espansione della vite

**DERNIER, PAIR OF MOTORCYCLE HANDLEBAR REARVIEW MIRRORS**

- Adjustable
- Handlebar fitting
- 13-18mm expansion of the screw

<b>90491</b>	Nero	Black
<b>90492</b>	Alluminio	Aluminium

Scatola / Box 5 / 30

Non omologati per uso stradale  
Not approved for road use



**2**  
pcs

**SX** + **DX**



1 pc

Alluminio  
Aluminium

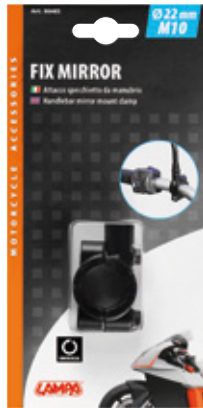

**FIX MIRROR, ATTACCO SPECCHIETTO DA MANUBRIO**

Per manubri Ø 22 mm, filettatura specchio M10 destro

**FIX MIRROR, HANDLEBAR MIRROR MOUNT CLAMP**

Suitable for Ø 22 mm handlebar, M10 right mirror thread

**90485**

Blister 10 / 100



**ADATTATORE PER SPECCHI MOTO**

Filettatura passo 1,25 mm

**MIRROR ADAPTERS**

Thread pitch 1,25 mm

<b>90137</b>	M10 DX > M10 SX
<b>90138</b>	M10 DX > M10 DX
<b>90139</b>	M10 DX > M8 DX
<b>90140</b>	M10 DX > M8 SX
<b>90150</b>	M8 DX > M10 DX
<b>90151</b>	M8 DX > M10 SX



D/Blister 10 / 100

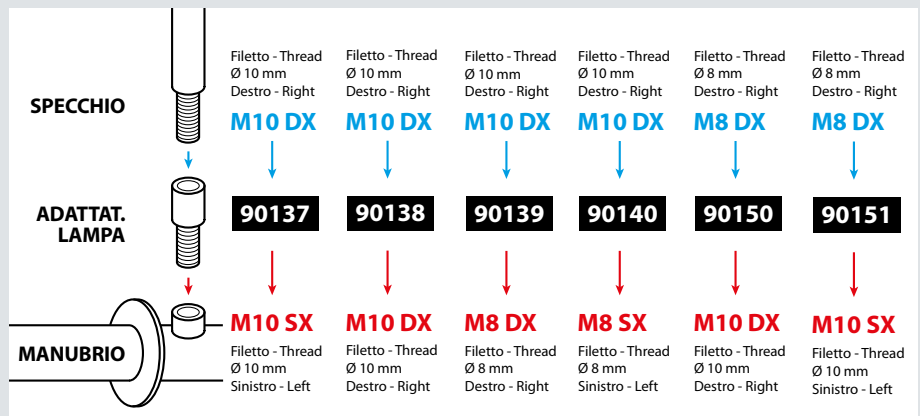

**TABELLA APPLICAZIONE MOTO**

Aprilia	<b>M10 DX</b>	<b>M10 DX - SX</b>
Bmw	<b>M10 DX - M8 DX</b>	<b>M10 DX - M8 DX</b>
Cagiva	<b>M10 DX</b>	<b>M10 DX</b>
Ducati	<b>M10 DX</b>	<b>M10 DX - SX</b>
Honda	<b>M10 DX</b>	<b>M10 DX</b>
Kawasaki	<b>M10 DX</b>	<b>M10 DX</b>
Moto Guzzi	<b>M10 DX</b>	<b>M10 DX</b>
Suzuki	<b>M10 DX</b>	<b>M10 DX</b>
Triumph	<b>M10 DX</b>	<b>M10 DX</b>
Yamaha	<b>M10 DX</b>	<b>M10 SX</b>

**TABELLA APPLICAZIONE SCOOTER**

Aprilia	<b>M8 DX</b>	<b>M8 DX - SX</b>
Cagiva	<b>M8 DX</b>	<b>M8 DX - SX</b>
Honda	<b>M8 DX</b>	<b>M8 DX</b>
Suzuki	<b>M8 DX</b>	<b>M8 DX</b>
Piaggio	<b>M8 DX</b>	<b>M8 DX</b>
Yamaha	<b>M8 DX</b>	<b>M8 SX</b>



**COPPIA STABILIZZATORI MANUBRIO**

Migliorano la stabilità della moto e riducono le vibrazioni sul manubrio  
Realizzati in alluminio anodizzato

**UNIVERSAL BAR ENDS (2 PCS)**

Improve the stability of the motorcycle and reduce vibrations on the handlebar.  
Made of anodised aluminium

Alluminio anodizzato  
Anodized aluminium

Ricavati dal pieno  
One piece construction



La misura indicata è riferita al diametro interno del manubrio  
The size refers to the internal handlebar diameter



2 pcs  
SET



Misura / Size	Ø 17÷23 mm	
<b>90635</b>	Alluminio	Aluminium
<b>90636</b>	Nero	Black

Scatola / Box 5 / 50



Misura / Size	Ø 17÷23 mm	
<b>90637</b>	Alluminio	Aluminium
<b>90638</b>	Nero	Black

Scatola / Box 5 / 50



Misura / Size	Ø 17÷23 mm	
<b>90317</b>	Nero	Black

D/Blister 5 / 50



Misura / Size	Ø 17÷23 mm	
<b>90322</b>	Blu	Blue
<b>90323</b>	Oro	Gold
<b>90324</b>	Rosso	Red
<b>90325</b>	Alluminio	Aluminium
<b>90639</b>	Nero	Black

D/Blister 5 / 50



Misura / Size	Ø 13÷17 mm	
<b>90318</b>	Blu	Blue
<b>90319</b>	Oro	Gold
<b>90320</b>	Rosso	Red
<b>90321</b>	Alluminio	Aluminium
<b>90644</b>	Nero	Black

D/Blister 5 / 50



Misura / Size	Ø 17÷23 mm	
<b>90315</b>	Rosso	Red

D/Blister 5 / 50



Misura / Size	Ø 17÷23 mm	
<b>90313</b>	Alluminio	Aluminium

D/Blister 5 / 50



**COPPIA STABILIZZATORI MANUBRIO**

Migliorano la stabilità della moto e riducono le vibrazioni sul manubrio. Realizzati in alluminio verniciato.

**UNIVERSAL BAR ENDS (2 PCS)**

Improve the stability of the motorcycle and reduce vibrations on the handlebar. Made of painted aluminium.



La misura indicata è riferita al diametro interno del manubrio. The size refers to the internal handlebar diameter.

Alluminio verniciato  
Painted aluminium



Misura / Size  $\varnothing 17\div 23$  mm

**90314** Carbon look

D/Blister 5 / 50

Misura / Size  $\varnothing 17\div 23$  mm

**90242** Blu Blue

**90243** Oro Gold

**90244** Rosso Red

D/Blister 5 / 50



**STABILIZZATORI MANUBRIO CON LED, 12V**

Aumentano la visibilità della moto. Riducono le vibrazioni sul manubrio. Per manubri con foro da  $\varnothing 17$  a 23 mm.

**LED-LIGHTED BAR ENDS, 12V**

Improve the motorcycle visibility. Reduce handlebar vibrations.  $\varnothing 17 / 23$  mm fitting.

**90240** Nero Black

**90241** Carbon Carbon

D/Blister 5 / 50



\* La funzione "Luce di Posizione" non è omologata per uso stradale. \* Position light is not approved on public roads.



**BLUE-WINGS, STABILIZZATORI ILLUMINATI, 12V**

In lega di alluminio, terminale illuminato a led blu. Per manubri con fori da  $\varnothing 17$  a 23 mm.

**BLUE-WINGS, BLUE LIGHTED BAR ENDS, 12V**

Aluminium. Long life Led, simple 2 wire connections.  $\varnothing 17 / 23$  mm fitting.

**90316**

D/Blister 5 / 50

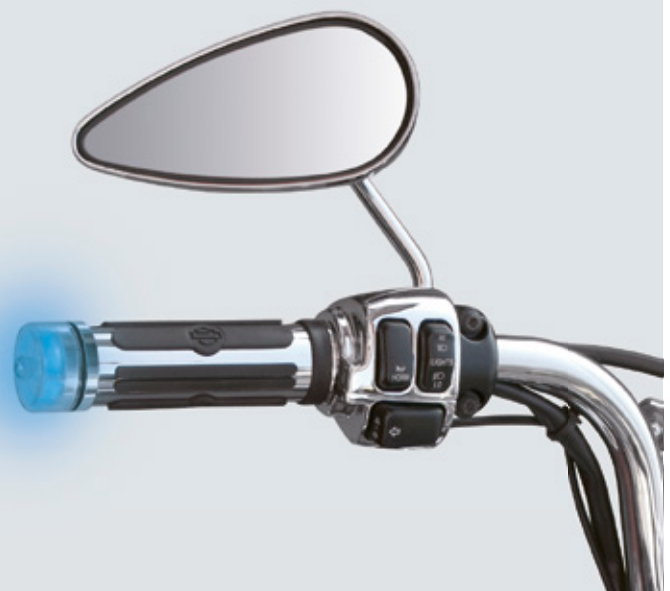



Manopole universali per moto, scooter e quad con impugnatura standard  
 Universal grips for motorcycle, scooters and quads with standard hand grips



Tatoo

90293

D/Blister 5 / 50

GOMMA + ALLUMINIO



Soft Grip

90306

D/Blister 5 / 50



Road-Grip

90308

D/Blister 5 / 50



Off-Road

90307

D/Blister 5 / 50

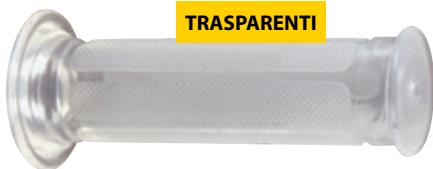

TRASPARENTI

X-Type

90304

D/Blister 5 / 50



G-Pulse

90294 Giallo Yellow

90298 Verde Green

D/Blister 5 / 50



GOMMA + ALLUMINIO

Metal-Grips

90309 Blu Blue

90310 Oro Gold

90311 Rosso Red

90312 Aluminium

D/Blister 5 / 50

Cruising

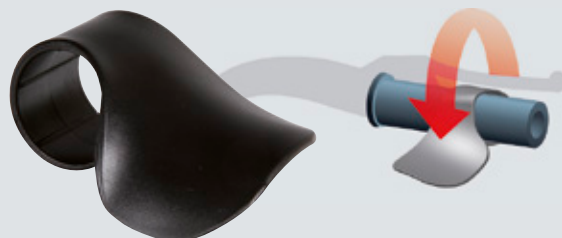

**CRUISING, LEVA RIPOSA POLSO PER ACCELERATORE**  
 Permette di mantenere una velocità costante lasciando il polso in posizione di riposo. Aiuta a ridurre l'affaticamento durante i viaggi e i lunghi percorsi. Universale. Facile da installare e da utilizzare

**CRUISING, ANTI-FATIGUE THROTTLE ASSIST**  
 Helps to maintain constant speed while resting your wrist

90073

D/Blister 5 / 50



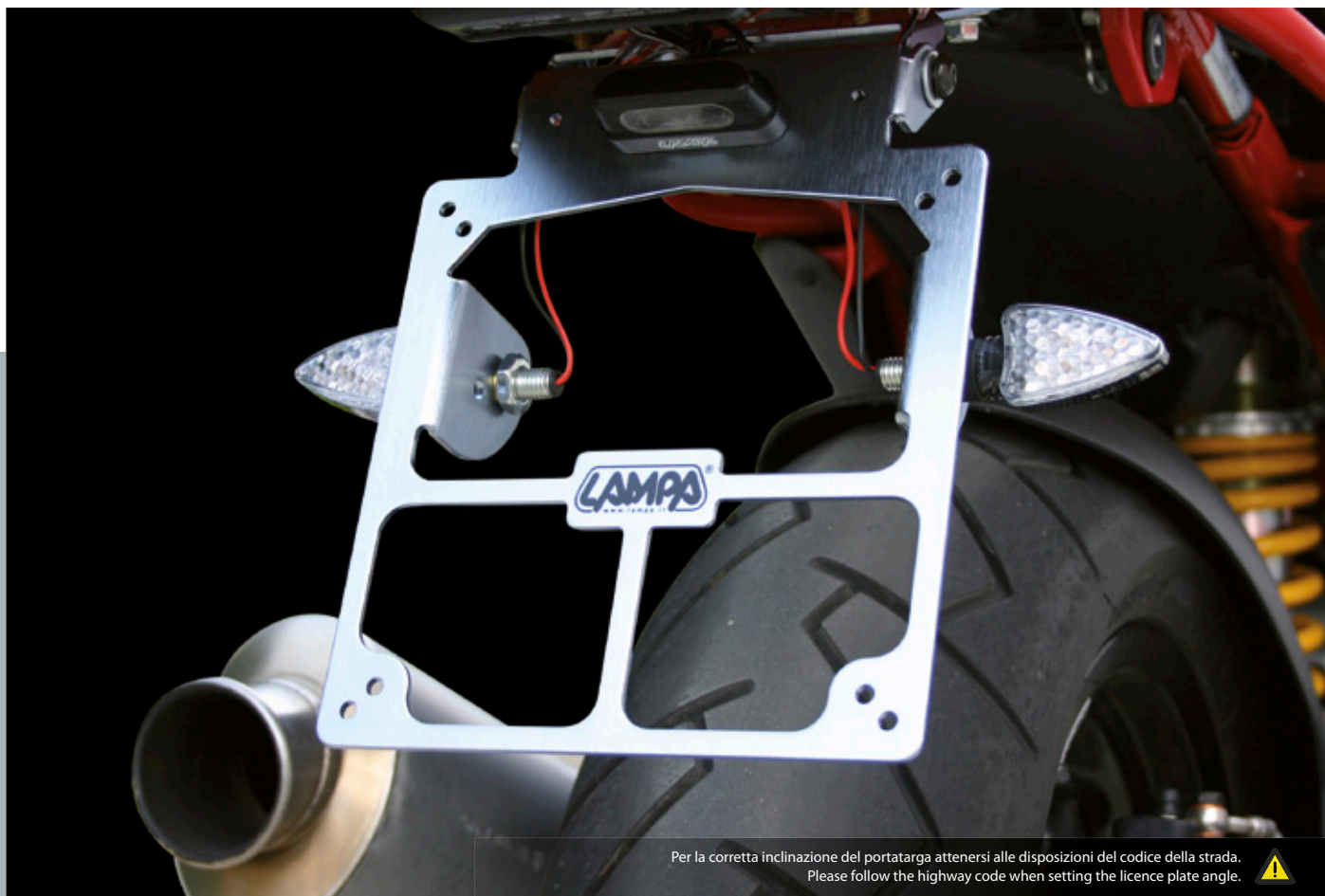

Per la corretta inclinazione del portatarga attenersi alle disposizioni del codice della strada.  
Please follow the highway code when setting the licence plate angle.

# X-Treme

**XTREME, PORTATARGA UNIVERSALE**  
In alluminio. Regolazione inclinazione targa.  
Fori per fissaggio frecce e luce targa.

**XTREME, UNIVERSAL LICENCE PLATE HOLDER**  
Alloy made. Adjustable inclination number plate.  
Holes for fixing corner lights and light plate.

<b>90142</b>	Aluminium
<b>90153</b>	Nero Black

D/Blister 5 / 20

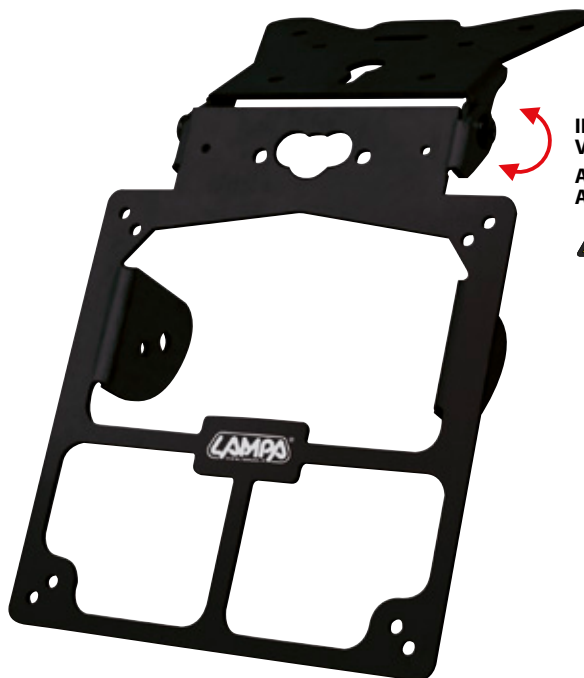

**INCLINAZIONE  
VARIABILE  
ADJUSTABLE  
ANGLE**

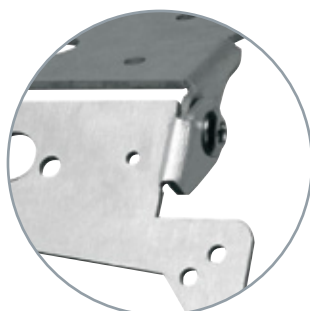
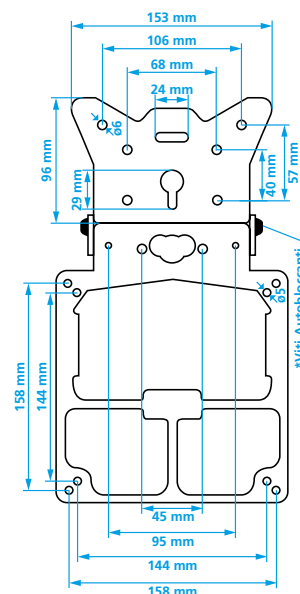

INCLINAZIONE  
VARIABILE  
ADJUSTABLE  
ANGLE

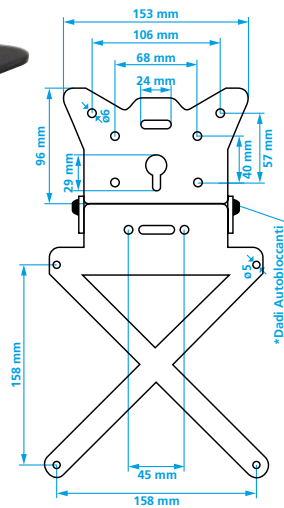

# X-Plate

**X-PLATE, PORTATARGA**

Alluminio anodizzato. Inclinazione regolabile. Peso 250 grammi. Predisposizione per frecce e luce targa.

**X-PLATE, LICENCE PLATE HOLDER**

Aluminium material. Adjustable angle. Weight 250 grams. Ready-made for corner lights and licence plate lamp.

**90144** Nero Black

D/Blister 5 / 20



INCLINAZIONE  
VARIABILE  
ADJUSTABLE  
ANGLE

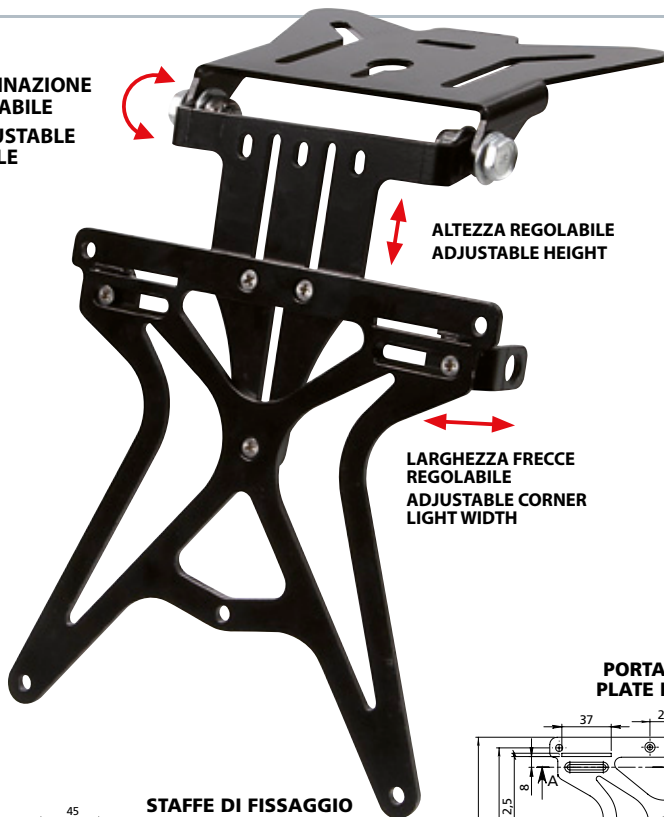

ALTEZZA REGOLABILE  
ADJUSTABLE HEIGHT

LARGHEZZA FRECCHE  
REGOLABILE  
ADJUSTABLE CORNER  
LIGHT WIDTH

**PORTATARGA  
PLATE HOLDER**

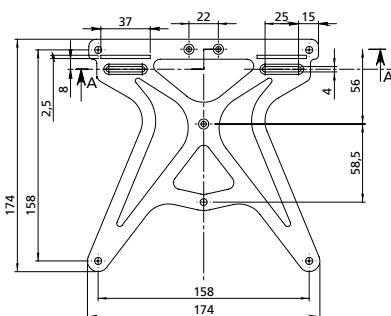

**STAFFE DI FISSAGGIO  
FIXING PLATES**

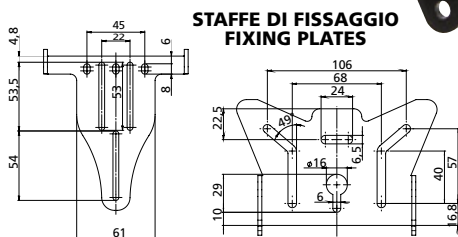

# Aero-X

**AERO-X, PORTATARGA  
COMPLETAMENTE REGOLABILE**

Attacco sottocodone piatto. Finitura a polvere epossidica. Regolazione altezza, larghezza ed inclinazione. Regolazione escursione frecce. Predisposizione luce targa

**AERO-X, FULLY ADJUSTABLE LICENCE PLATE  
HOLDER**

Aluminium material. Adjustable angle. Weight 250 grams. Ready-made for corner lights and licence plate lamp.

**90146** Nero Black

D/Blister 5 / 50







**PORTATARGA UNIVERSALE MOTO  
UNIVERSAL MOTORCYCLE  
LICENCE HOLDER**

**90143** 188x208 mm

Sfuso / Bulk 5



**PORTA TARGA IN ACCIAIO INOX  
MOTORCYCLE LICENCE PLATE HOLDER**

**90147** Cromo 185x185 mm  
**90148** Nero

Busta / Bag 10 / 50



ACCIAIO INOX  
STAINLESS STEEL

**CORNICE TARGA IN  
ACCIAIO INOX  
MOTORCYCLE LICENCE  
PLATE FRAME**

**90149** 185x185 mm

Busta / Bag 10 / 50



**SUPPORTO PER CATARIFRANGENTE TARGA  
REFLECTOR HOLDER**

In alluminio anodizzato. Asole di fissaggio.  
Aluminium material. Fitting loops.

**90145**

D/Blister 10 / 50



**SET 100 BOTTONCINI**

Per il fissaggio della targa sul portatarga.  
Idonei per tutti i portatarga Lampa

**SET 100 PCS SMALL BUTTONS**

**19914** Bianco White  
**19915** Azzurro Light blue

Busta / Bag 100 / 1000



ACCIAIO  
STEEL

**CORNICE TARGA MOTO  
IN ACCIAIO**

Verniciatura a polvere nera  
**STEEL MOTORCYCLE  
LICENCE PLATE FRAME**  
Black powder painting

**90481** Nero Black 185x185 mm

Busta / Bag 10 / 50



**PORTATARGA UNIVERSALE PER  
CICLOMOTORI**

Con omologazione al trasporto di  
un passeggero.

**UNIVERSAL SCOOTER LICENCE  
HOLDER**

**90141** 150x155 mm

Sfuso / Bulk 5

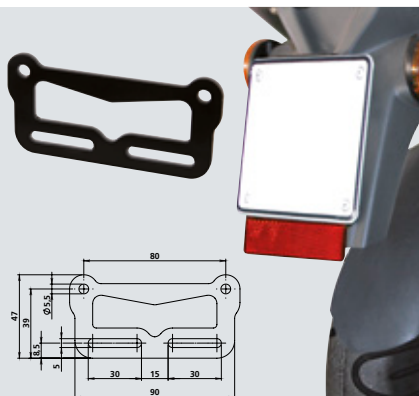

**SUPPORTO PER CATARIFRANGENTE  
TARGA CICLOMOTORI**

In alluminio. Finitura a polvere epossidica.  
Peso 20 g  
**REFLECTOR HOLDER**  
Made of aluminium. Black epoxy coated.  
Weight 20 g

**90189**

D/Blister 10 / 50

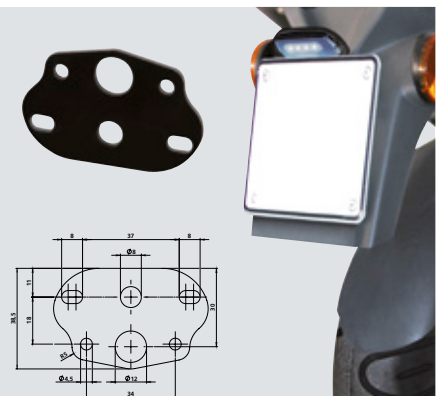

**SUPPORTO LUCE TARGA PER CICLOMOTORI**

In alluminio. Peso 13 g  
Finitura a polvere epossidica.  
**REFLECTOR HOLDER FOR MOPEDS**  
Made of aluminium. Weight 13 g  
Black epoxy coated.

**90190**

D/Blister 10 / 50

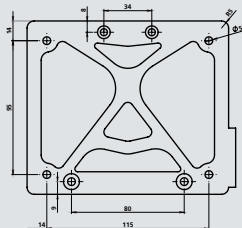
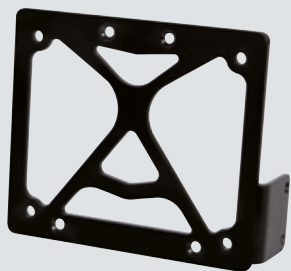

**KUOX, PORTATARGA LATERALE**  
In alluminio. Peso 85 g.  
Finitura a polvere epossidica.  
Predisposizione per luce targa

**KUOX, SIDE LICENCE PLATE HOLDER FOR MOPEDS**  
Made of aluminium.  
Weight 85 g.  
Black epoxy coated.  
Ready made for plate light

**90185**

D/Blister 10 / 50

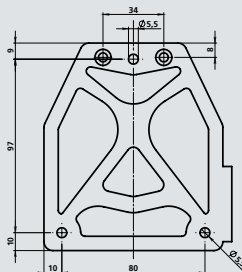

**NAXOX, PORTATARGA LATERALE PER CICLOMOTORI**  
In alluminio. Peso 60 g.  
Finitura a polvere epossidica.  
Predisposizione per luce targa

**NAXOX, SIDE LICENCE PLATE HOLDER FOR MOPEDS**  
Made of aluminium.  
Weight 60 g.  
Black epoxy coated.  
Ready made for plate light

**90186**

D/Blister 10 / 50

INCLINAZIONE  
VARIABLE  
ADJUSTABLE  
ANGLE

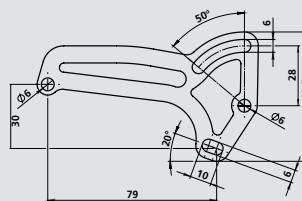
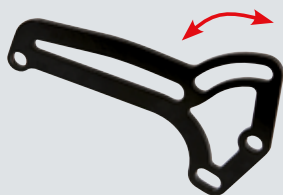

**SUPPORTO PER TARGA LATERALE IDONEO PER BLOCCO MOTORE PIAGGIO**  
In alluminio.  
Finitura a polvere epossidica.  
Peso 15 g

**SIDE LICENCE PLATED HOLDER FOR SCOOTERS WITH PIAGGIO ENGINE**  
Made of aluminium.  
Black epoxy coated.  
Weight 15 g

**90187**

D/Blister 10 / 50

INCLINAZIONE  
VARIABLE  
ADJUSTABLE  
ANGLE

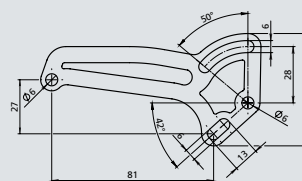
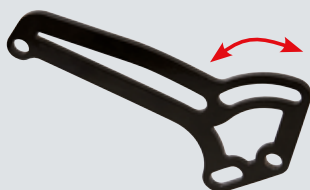

**SUPPORTO PER TARGA LATERALE IDONEO PER BLOCCO MOTORE MINARELLI**  
In alluminio.  
Finitura a polvere epossidica.  
Peso 15 g

**SIDE LICENCE PLATED HOLDER FOR SCOOTERS WITH MINARELLI ENGINE**  
Made of aluminium.  
Black epoxy coated.  
Weight 15 g

**90188**

D/Blister 10 / 50

2 pcs SET



Grip-Tank x1

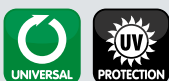
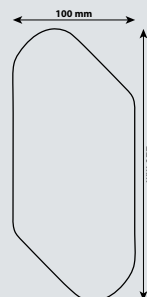

**GRIP-TANK X1, PROTEZIONI ADESIVE PER SERBATOIO**

- Si applica in pochi secondi.
- Protegge il serbatoio dai graffi causati dallo sfregamento delle gambe.
- Aiuta a ridurre l'affaticamento durante le frenate.

**GRIP-TANK X1, ADHESIVE TANK PADS**

Easy mounting. Protects the tank from scratches and scuffs caused by rubbing the legs against the body. Helps reduce fatigue during braking.

<b>90508</b>	Nero	Black
<b>90509</b>	Trasparente	Clear

Blister 10 / 100



**COPERTURA TAPPO CARBURANTE**

Si applica in pochi secondi. Impermeabile e anti-UV.

**FUEL CAP COVER**

Easy mounting. Water and uv-proof.

D/Blister 5 / 25



**90004** 5 fori / holes

Yamaha

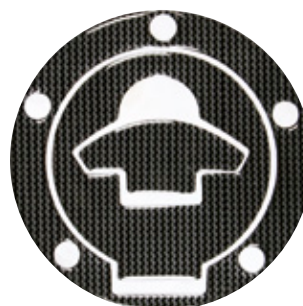

**90007** 5 fori / holes

Ducati

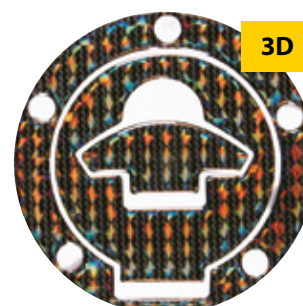

**90008** 5 fori / holes

Ducati

3D

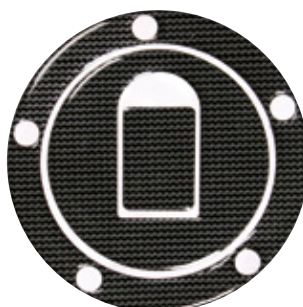

**90003** 5 fori / holes

Kawasaki  
Suzuki

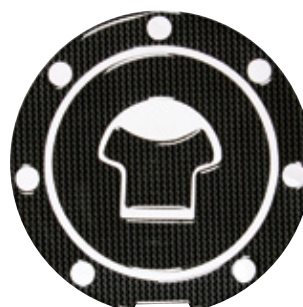

**90005** 7 fori / holes

Honda

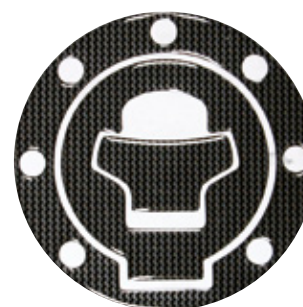

**90009** 7 fori / holes

Suzuki



# Pro-Tank

**PROTEZIONI ADESIVE PER SERBATOIO**

Si applicano in pochi secondi.  
 Proteggono il serbatoio dai graffi causati dallo sfregamento di cinture, cerniere o bottoni. Impermeabili ed anti UV.

**ADHESIVE TANK PADS**

Easy mounting. Protects the tank from scratches normally caused by belts, zips, button. Water and UV-proofs.

Blister 10 / 100

## Pro-Tank x1

<b>90010</b>	Carbon
<b>90094</b>	Nero Black

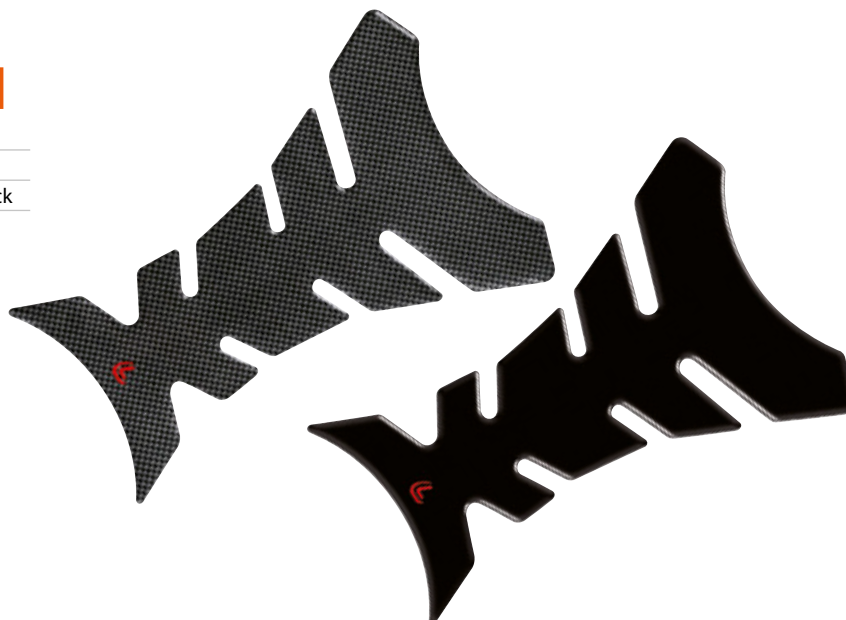
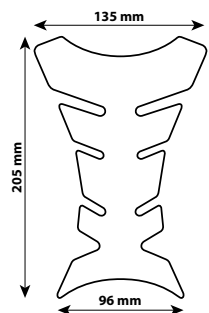

## Pro-Tank x2

<b>90510</b>	Carbon
<b>90511</b>	Nero Black

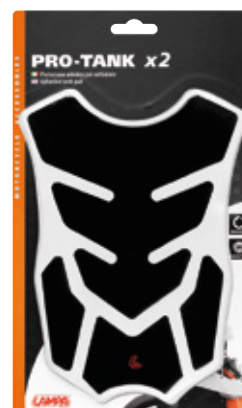
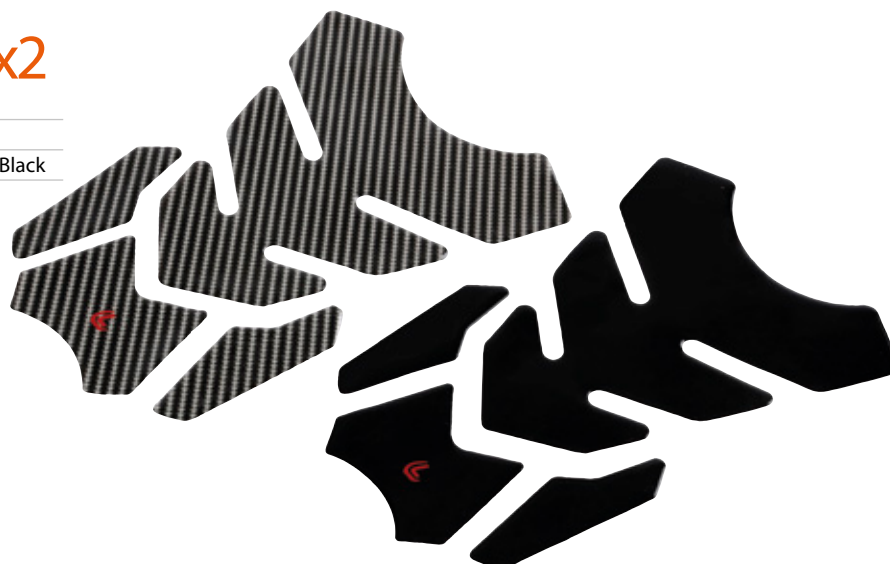
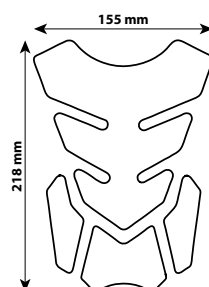

## Pro-Tank x3

<b>90512</b>	Carbon
<b>90513</b>	Nero Black

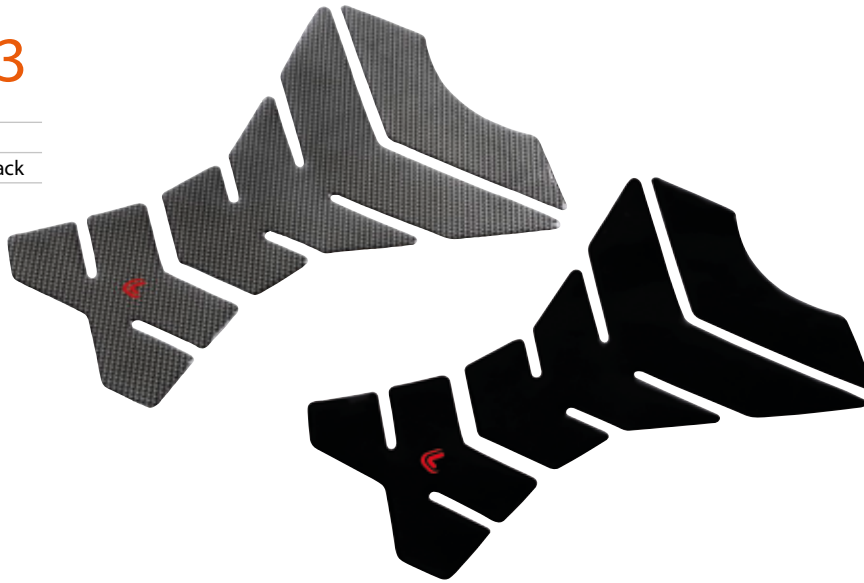
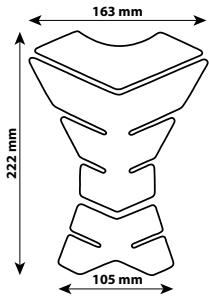

## Pro-Tank x4

<b>90514</b>	Carbon
<b>90515</b>	Nero Black

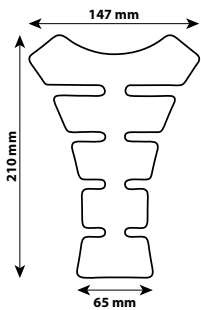

## Pro-Tank x5

<b>90516</b>	Carbon
<b>90517</b>	Nero Black

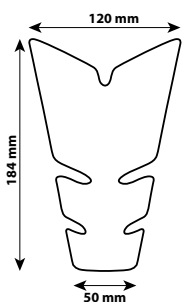

*3D Carbon look*



# Wheel Stripe

## PROFILO ADESIVO PER CERCHI MOTO

Kit per 2 cerchi moto. Universale.  
Altezza 7 mm. Lunghezza 600 cm.  
Applicatore incluso

## ADHESIVE TRIM FOR MOTORCYCLE RIMS

Kit for 2 motorcycle wheels.  
Universal fit.  
Height 7 mm. Total length 600 cm.  
Dispenser included

Blister 100

Made in  
ITALY



**7mm x 6m**

per 2 cerchi / for 2 wheels



## Racing

Tinte con colori pastello.

Colours with pastel colors.

<b>90520</b>	Nero	Black
<b>90521</b>	Argento	Silver
<b>90522</b>	Rosso	Red
<b>90523</b>	Blu	Blue
<b>90524</b>	Verde	Green
<b>90525</b>	Arancio	Orange



Con applicatore  
With dispenser



## Fluo

Tinte fluorescenti che migliorano la visibilità durante il giorno.

Fluorescent colours that improve day visibility.

<b>90526</b>	Rosso	Red
<b>90527</b>	Giallo	Yellow

Con applicatore  
With dispenser



## Reflective

Tinte rifrangenti metallizzate che migliorano la visibilità della moto sia durante il giorno che di notte.

Reflective metallic paints that improve the day and at night visibility of the bike.

<b>90528</b>	Bianco	White
<b>90529</b>	Rosso	Red

Con applicatore  
With dispenser



Maggiore visibilità di notte  
Increase night visibility

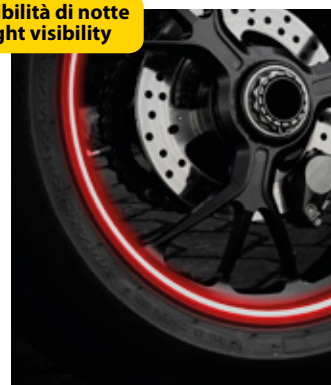



Con applicatore  
With dispenser

**PROFILO RIFLETTENTE ADESIVO**

Kit per 2 cerchi. Universali.  
Altezza 5 mm. Lunghezza 750 cm.  
Applicatore incluso

**REFLECTIVE ADHESIVE TRIM**

Kit for 2 rims. Universal fit.  
Height 5 mm. Total length 750 cm.  
Dispenser included

<b>90041</b>		Rosso	Red
<b>90042</b>		Verde	Green
<b>90043</b>		Bianco	White
<b>90044</b>		Giallo	Yellow
<b>90045</b>		Arancio	Amber
<b>90046</b>		Argento	Silver
<b>90047</b>		Blu	Blue

D/Blister 10 / 80

**RIM-STICKERS, PROFILI ADESIVI RUOTA**

- Pre-sagomati, pronti per una facile applicazione senza pieghe o grinze.
- Materiale plastico ed adesivo specifici per uso esterno.
- Semplice da applicare e di grande effetto visivo.

**RIM-STICKERS**

- Pre-cut, ready for an easy and simple application without creases or wrinkles.
- Special Plastic material and adhesive for exterior use.
- Standout in the crowd

D/Blister 10 / 100

# Rim-Stickers

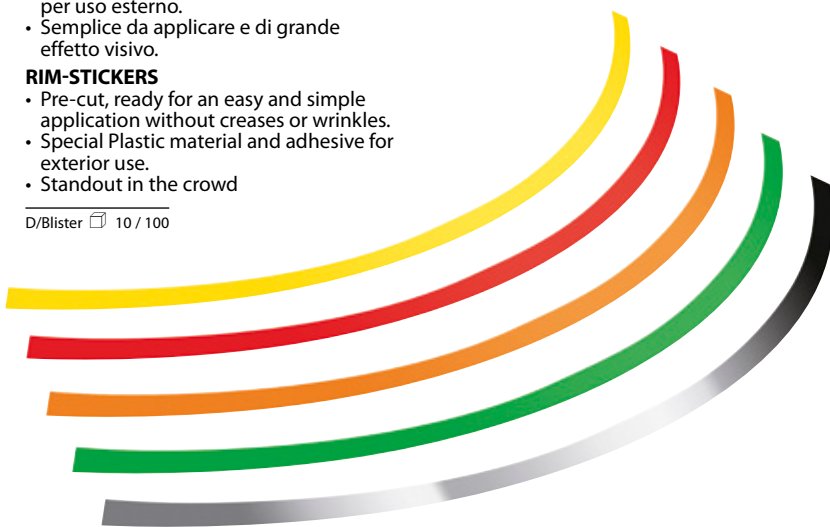

**SIZE 1**  
14'' - 15''  
16''



**SIZE 2**  
17'' - 18''  
19'' - 20''

PER CERCHI FOR WHEELS **14'' - 15'' - 16''**

<b>30780</b>		Cromo	Chrome	<b>SIZE 1</b>
<b>30781</b>		Verde	Green	
<b>30782</b>		Arancio	Orange	
<b>30783</b>		Rosso	Red	
<b>30784</b>		Giallo	Yellow	

PER CERCHI FOR WHEELS **17'' - 18'' - 19'' - 20''**

<b>30785</b>		Cromo	Chrome	<b>SIZE 2</b>
<b>30786</b>		Verde	Green	
<b>30787</b>		Arancio	Orange	
<b>30788</b>		Rosso	Red	
<b>30789</b>		Giallo	Yellow	

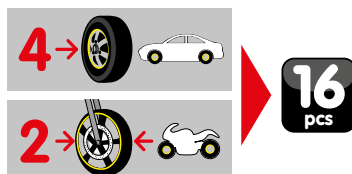



# WRAPPER<sup>®</sup>

removable spray paint

**PELLICOLA SPRAY REMOVIBILE**  
**REMOVABLE SPRAY FILM**



**TI SEI STANCATO ?  
LO RIMUOVI FACILMENTE !  
TIRED OF IT ?  
YOU CAN EASILY REMOVE IT**







Resa per 1 bomboletta:  
1 spray can paint  
**0,5 mq**  
Viscosità - Viscosity:  
**6500-7000 mPA.s (20°C)**  
Pressione bombola:  
Spray pressure  
da **4,2 a 4,8 Bar a 20°C**  
da **7,6 a 8,4 Bar a 50°C**



**ESPOSITORE DA 20 BOMBOLETTE**  
Fornito vuoto  
**COUNTER DISPLAY, 20 PCS**  
Supplied empty

**WR000**

Termoretraibile / Thermo 1



**WRAPPER, PELLICOLA SPRAY RIMOVIBILE, 400 ML**

Wrapper è una vernice spray removibile che ti permette di dipingere in modo reversibile qualsiasi oggetto o superficie. Con la sua particolare formulazione, Wrapper crea una pellicola elastica e adesiva che protegge ed impermeabilizza. Wrapper non aggredisce la superficie sottostante, che rimane inalterata, e può essere rimosso facilmente dopo ore, mesi o anni. Ideale per metalli, plastica, alluminio, carbonio, vetro, legno trattato e per tutte le superfici piane, ondulate, flessibili, lisce o ruvide. Colora e protegge la carrozzeria dell'auto, i cerchioni, gli specchietti, le mascherine e i loghi. Ideale per tutte le parti in plastica, in metallo, in vetroresina o in vetro. Studiata anche per moto, scooter, biciclette e per dare una nuova immagine a tutto ciò che volete.

**WRAPPER, REMOVABLE SPRAY FILM, 400 ML**

Wrapper is a removable spray paint that allows you to paint reversibly any object or surface. With its particular formulation, Wrapper creates an elastic and adhesive film that protects and waterproofs. Wrapper does not attack the underlying surface, which remains unaltered, and can be easily removed after hours, months or years. Ideal for metals, plastic, aluminium, carbon, glass, treated wood and for all flat, wavy, flexible, smooth or rough surfaces. Colours and protects the car body, rims, mirrors, masks and logos. Ideal for all plastic, metal, fiberglass or glass parts. Also designed for motorcycles, scooters, bicycles and to give a new image to everything you want.

Scatola / Box 4

**ACCESSORI - ACCESSORIES**

**PISTOLA PER BOMBOLETTA**

Semplifica l'utilizzo della bomboletta consentendo risultati più accurati

**HANDLE SPRAY GUN**

More comfort in painting with accurate results

**WR001**

Busta / Bag 1



**RESISTE DA -40°C A +120°C**  
RESISTANCE BETWEEN -40°C AND +120°C



**IMPERMEABILE E PROTETTIVO**  
WATERPROOF AND PROTECTIVE



**RESISTENTE ED ELASTICO**  
RESISTANT AND FLEXIBLE



**NON AGGREDISCE LE SUPERFICI**  
IT DOES NOT DAMAGE SURFACES



**RESISTENTE ALL'AUTOLAVAGGIO**  
RESISTANT TO CAR WASH



**RESISTENTE ALL'IDROPULTRICE**  
RESISTANT TO PRESSURE WASHER



**DARE ALMENO 3/4 MANI**  
SPRAY AT LEAST 3/4 COATS



**FINITURA OPACA/LUCIDA**  
MATT/GLOSS FINISH

**KIT VERNICIATURA 4 CERCHI**

60 cartoncini copri pneumatico  
4 cappucci copri valvola  
4 erogatori professionali regolabili

**WHEEL KIT**

60 masking cards  
4 valve covers  
4 red actuators

**WR002**

Busta / Bag 1



**TINTE RAL - RAL COLOURS**

PELLICOLE SPRAY RIMOVIBILI - REMOVABLE SPRAY FILMS



**WR1023**  
RAL 1023  
Giallo traffico  
Traffic yellow



**WR2004**  
RAL 2004  
Arancio puro  
Pure orange



**WR3020**  
RAL 3020  
Rosso traffico  
Traffic red



**WR3000**  
RAL 3000  
Rosso fuoco  
Flame red



**WR4003**  
RAL 4003  
Viola Erika  
Heater violet



**WR3015**  
RAL 3015  
Rosa chiaro  
Light pink



**WR4005**  
RAL 4005  
Lilla bluastro  
Blue lilac



**WRC31**  
RAL C31  
Blu Napoli  
Naples blue



**WR5017**  
RAL 5017  
Blu traffico  
Traffic blue



**WR5018**  
RAL 5018  
Turchese  
Turquoise



**WR6029**  
RAL 6029  
Verde menta  
Mint green



**WR7001**  
RAL 7001  
Grigio argento  
Silver grey



**WR8017**  
RAL 8017  
Marrone cioccolato  
Chocolate brown



**WR9005M**  
RAL 9005  
Nero opaco  
Matt black



**WR9016M**  
RAL 9016  
Bianco puro  
Pure white

**TINTE FLUO - NEON COLOURS**

PELLICOLE SPRAY RIMOVIBILI - REMOVABLE SPRAY FILMS

Attenzione: per i fluorescenti usare wrapper bianco come base - Attention: for the neon colours use white wrapper as base coat



**WR2211**  
Giallo fluo  
Neon Yellow



**WR2711**  
Fuxia fluo  
Neon fuxia



**WR2311**  
Rosso fluo  
Neon red



**WR2511**  
Verde fluo  
Neon green



**WR2411**  
Azzurro fluo  
Neon light blue

**TINTE METALLIZZATE - METALLIC COLOURS**

PELLICOLE SPRAY RIMOVIBILI - REMOVABLE SPRAY FILMS



**WR7523**  
Grigio titanio metallizzato  
Metallic titanium grey



**WR8509**  
Bronzo metallizzato  
Metallic bronze



**WR5500**  
Blu metallizzato  
Metallic Blue



**WR0232**  
Nero metallizzato  
Metallic black



**WR7530**  
Grigio alluminio metallizzato  
Metallic aluminium grey

**TINTE SPECIALI - SPECIAL COLOURS**

PELLICOLE SPRAY RIMOVIBILI - REMOVABLE SPRAY FILMS



**WR5127**

Blu scuro navy  
Navy dark blue



**WR6106**

Verde Kawasaki  
Kawasaki green



**CARTELLA COLORI**  
COLOR CHART



**WR2902**

Oro  
Gold



**WR2905**

Argento  
Silver



**WR7105**

Grigio Nardo  
Nardo grey



**WR1500**

Glitter oro  
Gold glitter



**WR7500**

Glitter argento  
Silver glitter

**TINTE ARMY - CAMOUFLAGE COLOURS**

PELLICOLE SPRAY RIMOVIBILI - REMOVABLE SPRAY FILMS



**WR6013**

Verde canna  
Reed green



**WR6114**

Kaki olive



**WR7107**

Grigio verde  
Grey green



**WR7108**

Grigio scuro  
Dark grey



**WR5115**

Blue horizon



**WR7207**

Sahara dust



**WR1106**

Beige sabbia  
Beige sand



**WR8341**

Mostarda  
Mustard



**WR7033**

Ral 7033 Republic

**TRASPARENTI - CLEAR**

PELLICOLE SPRAY RIMOVIBILI - REMOVABLE SPRAY FILMS

I colori lucidi sono utilizzabili da soli o per dare finitura lucida e perlata a tutti gli altri colori - Glossy colors are usable alone or as a final coat to add a glossy or pearlescent finish to all other colors



**WR2001M**

Trasparente opaco  
Matt clear



**WR2001**

Trasparente lucido  
Gloss clear



**WR0040**

Trasparente lucido perlato  
Space violet clear

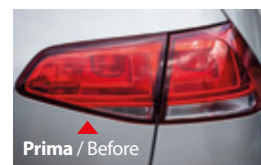

Prima / Before

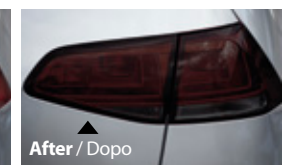

After / Dopo

**WR0295**

Oscurante fanali  
Tail light darkener

Non omologato per uso stradale.  
Not approved for road use.



**Adatta anche per superfici ruvide**  
**Ok for rough surfaces**

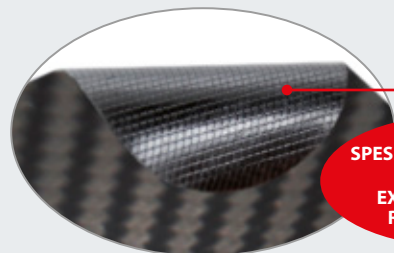

**Micro-scanalature**  
**Air-Release Channels**

**SPESSORE MAGGIORATO CON RILIEVO**  
**EXTRA THICK REAL RELIEF PATTERN**

**SUPER-TECH, PELLICOLA ADESIVA CARBON-LOOK 3D**

- Facile da applicare, senza formazione di bolle d'aria, grazie alle speciali micro-scanalature.
- Adesivo speciale per applicazione sia su superfici lisce che ruvide, all'interno oppure all'esterno.
- Può essere facilmente rimossa e riapplicata.
- Speciale per interni auto come cruscotto, plancia, inserti portiere...
- Flessibile e termo-formabile con phon, può essere scaldata e modellata per l'applicazione su superfici curve senza lasciare pieghe.

**SUPER-TECH, 3D CARBON-LOOK FILM**

- Can be applied to any surface, such as car, computers, phones...
- Easy to apply, without air-bubble thanks to the special air-release channels.
- Sticks onto smooth and rough surfaces, indoor or outdoor use.
- Removable and flexible for curves

<b>02965</b>	50x75 cm
<b>02966</b>	50x150 cm

Scatola / Box 50



**GHOST, PELLICOLA PROTETTIVA ADESIVA**

In PVC, protegge la superficie dai graffi. Ideale per cupolini, serbatoi, carene, telai.

**GHOST, ADHESIVE PROTECTIVE FILM**

PVC material, protects surfaces against scratches.

For fairing, frame and tank.

<b>90040</b>	Trasparente Clear	<b>50x50 cm</b>
--------------	-------------------	-----------------

Scatola / Box 6 / 36



Ghost

**PVC**



**3D LETTERS - CONFEZIONE SINGOLA**

Lettere, numeri e simboli adesivi prodotti in plastica a rilievo con cromatura a specchio. Retro con adesivo speciale per comporre ed applicare nomi, frasi o testi su qualsiasi superficie liscia

**3D LETTERS - SINGLE PACK**

Adhesive chromed letters, numbers and symbols

Busta / Bag 10 / 250



Type-1 18 mm



Type-2 26 mm



Type-3 28 mm

	Type 1	Type 2	Type 3
A	07911	07061	07861
B	07912	07062	07862
C	07913	07063	07863
D	07914	07064	07864
E	07915	07065	07865
F	07916	07066	07866
G	07917	07067	07867
H	07918	07068	07868
I	07919	07069	07869
J	07920	07070	07870
K	07921	07071	07871
L	07922	07072	07872
M	07923	07073	07873
N	07924	07074	07874
O	07925	07075	07875
P	07926	07076	07876
Q	07927	07077	07877
R	07928	07078	07878
S	07929	07079	07879
T	07930	07080	07880
U	07931	07081	07881
V	07932	07082	07882
W	07933	07083	07883
X	07934	07084	07884
Y	07935	07085	07885
Z	07936	07086	07886

	Type 1	Type 2	Type 3
0	07937	07087	07887
1	07938	07088	07888
2	07939	07089	07889
3	07940	07090	07890
4	07941	07091	07891
5	07942	07092	07892
6	07943	07093	07893
7	07944	07094	07894
8	07945	07095	07895
9	07946	07096	07896
&	07947	07097	07897
@	07948	07098	07898
??	07949	07099	-
!!	07950	07100	07900
::	07951	07101	07901
""	07952	07102	-
--	07953	07103	-
//	07954	-	07904
()	07955	07105	07905
+	07956	07106	07906
∫	07957	-	07907
♥	07958	07108	07908

# 3D Letters

**3D LETTERS - ESPOSITORE DA 480 PEZZI**

In plastica a rilievo con cromatura a specchio. Retro con adesivo speciale 48 caratteri assortiti per 10 pezzi

**3D LETTERS - 480 PCS WALL-DISPLAY**

Chromed relief plastic letters, with special adhesive 48 characters x 10 pcs each

07910	Type-1	
07060	Type-2	480 pz (48 caratteri x 10 pz)
07860	Type-3	

Scatola / Box 5

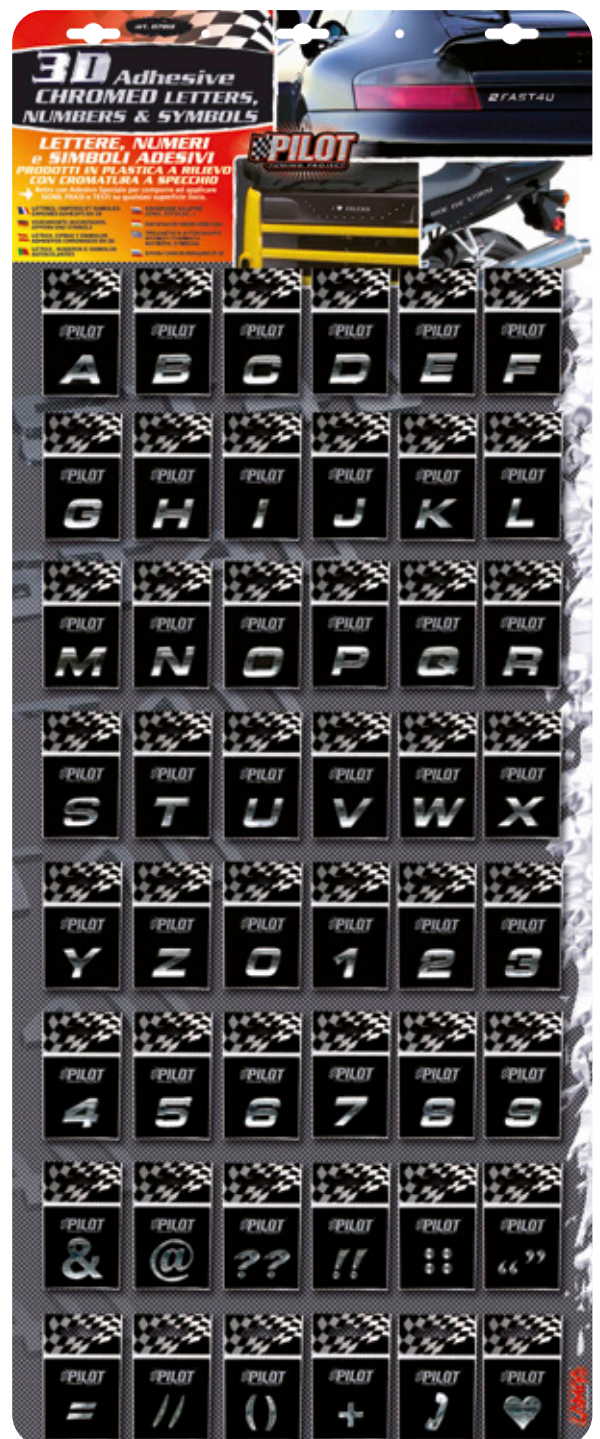

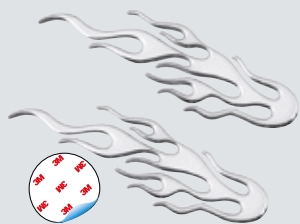

**EMBLEMA 3D CROMATO**  
Base adesiva speciale.  
Trattamento speciale al cromo  
**CHROMED 3D EMBLEM**

**15025** 2 x cm 13

D/Blister 10 / 100

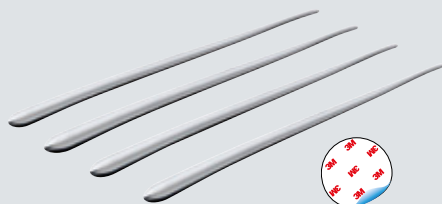

**MIRROR-TRIMS 4, DECORAZIONI ADESIVE CROMATE, 4 PZ**

Flessibili, per adattarsi meglio alle curvature. Adesivo speciale

**MIRROR-TRIMS 4, CHROMED ADHESIVE DECORATIONS, 4 PCS**  
May be curved to fit everywhere.  
Special ultra-strong adhesive

**20830** 170 mm

D/Blister 10 / 100



**PENNARELLO PER PNEUMATICI**  
Vernice ad alta copertura. Resistente all'acqua ed agli agenti atmosferici.

**TYRE PAINT PEN**  
High resistant instant dry paint marker

**74101** Bianco White

**74102** Argento Silver

D/Blister 10 / 200



# Spell-It

**SPELL-IT, LETTERE E NUMERI ADESIVI**  
Lettere 15x10 mm, numeri 140x65 mm.

**SPELL-IT, ADHESIVE CHARACTERS AND NUMBERS**  
Characters 15x10 mm,  
numbers 140x65 mm.



**CONFEZIONI SINGOLE  
SINGLE PACKS**

Busta / Bag 10 / 500

BIANCO WHITE	NERO BLACK	
<b>90371</b>	-	1
<b>90372</b>	<b>90383</b>	2
<b>90373</b>	<b>90384</b>	3
<b>90374</b>	<b>90385</b>	4
<b>90375</b>	<b>90386</b>	5
<b>90376</b>	-	6
<b>90377</b>	-	7
<b>90378</b>	-	8
<b>90379</b>	<b>90390</b>	9
<b>90380</b>	-	0
<b>90392</b>	<b>90393</b>	Kit lettere