

FERODO®

2020/21



CIRCUIT



MOTARD



OFF-ROAD



TRIAL

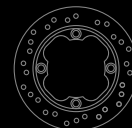
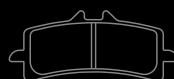

FERODO®

RACING

FERODO RACING'S NEW STANDARD: CPR0



Sandro Cortese – Kallio Racing Team – won the 2018 Supersport World Championship relying on Ferodo **CPR0** brake pads!

Developed from Ferodo's extensive racing heritage, **CPR0 compound** provides the performance and modulation required by the world's best riders.

www.ferodoracing.com

Ferodo® is a registered trademark of Federal-Mogul LLC or one or more of its subsidiaries in one or more countries.

FERODO®

RACING



PADS & SHOES - DISCS - CLUTCHES Technical information

I - IX

BRAKE FLUIDS Technical information

X - XI

PADS & SHOES

PRODUCT RANGE	1
MOTORCYCLE APPLICATIONS	1000
ATV & SNOWMOBILE APPLICATIONS	2000
PADS FOR RACING CALIPERS	3000
PAD DRAWINGS & BUYER'S GUIDE	4000
SHOE DRAWINGS	5000
SHOE BUYER'S GUIDE	6000
PADS XREF (COMPETITORS TO FERODO)	7000
SHOES XREF (COMPETITORS TO FERODO)	8000

DISCS

MOTORCYCLE APPLICATIONS	10000
ATV APPLICATIONS	11000
DISC DRAWINGS	12000
DISC BUYER'S GUIDE	13000
DISCS XREF (COMPETITORS TO FERODO)	14000

CLUTCHES

MOTORCYCLE APPLICATIONS	20000
SCOOTER CENTRIFUGAL APPLICATIONS	21000
CLUTCH KITS XREF (COMPETITORS TO FERODO)	22000
SPECIAL CLUTCH KITS DUCATI APPLICATIONS	23000
SPECIAL CLUTCH KITS OTHER APPLICATIONS	24000



PADS & SHOES

Ferodo's organic and sintered brake pads & shoes provide the performance and modulation appreciated by the world's best riders.

Composed of pressed metal powders which have been fused together at very high temperature

Sinter Grip Compounds



FDB**ST** 

For high performance road use



FDB**SM** 

For maxiscooter road use



FDB**SG** 

For off-road use



FDB**XRAC** 

For race use

Carbon based composites bound together with an organic resin

Carbon Grip Compounds



FDB**AG** 

For scooter road use



FDB**EF** 

For road, race use on rear brake, and off-road use



FDB**P** 

For road, race use on rear brake, and off-road use



FDB**PRP** 

For road use in combination with polished rotor (PRP = Polished Rotor Pad)

Carbon based composites bound together with a ceramic resin

Ceramic Grip Compound



FDB**CP1/CPR0** 

For race use

Shoes



FSB***

Brake shoes lined with organic friction material

**** = PAD/SHOE SHAPE NUMBER

Pad Compound Selection Guide Area

Principal type of use	Compound technology	Compound name	Material suffix code	Compatible with		Road		Light Competition		PRO Competition	
				Stainless steel discs	Cast iron discs	Front	Rear	Front	Rear	Front	Rear
ROAD	Carbon Grip	Argento	AG	👍	👍	👍	👍				
ROAD	Carbon Grip	Polished rotor pad	PRP	👍	👍	👍	👍				
ROAD/OFF-ROAD	Carbon Grip	Eco-Friction	EF	👍	👍	👍	👍				
ROAD/OFF-ROAD	Carbon Grip	Platinum	P	👍	👍	👍	👍	👍	👍		👍
ROAD	Sinter Grip	Maxiscooter	SM	👍		👍	👍				
ROAD	Sinter Grip	SinterGrip	ST	👍		👍	👍	👍	👍		👍
OFF-ROAD	Sinter Grip	SinterGrip	SG	👍		👍	👍	👍	👍	👍	👍
OFF-ROAD	Sinter Grip	SinterGrip	ZR	👍				👍		👍	
RACE	Sinter Grip	SinterGrip	XRAC	👍				👍		👍	
RACE	Sinter Grip	SinterGrip	ZRAC	👍				👍			
RACE	Ceramic Grip	CP1 / CPR0	CP1/CPR0	👍	👍			👍		👍	

FERODO RACE materials evaluated under RACE TRACK conditions

Grading Scale: 1 to 5



	Friction level cold	Friction level hot	Bite	Fade resistance	Controllability	Pad life	Disc life	Wet braking
XRAC	●●	●●●●●	●●●●●	●●●●●	●●●	●●●●●	●●●	●●●●●
ZRAC	●●●●●	●●●●	●●●	●●●	●●●	●●●●●	●●●	●●●●●
CP1/CPR0	●●	●●●●●	●●●●●	●●●●	●●●●●	●●●	●●●●●	●●●

FERODO ROAD materials evaluated under ROAD conditions

Grading Scale: 1 to 5

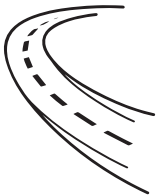

	Friction level	Bite	Fade resistance	Controllability	Pad life	Disc life	Wet braking	Comfort
EF	●●●	●●●	●●●●	●●●●	●●●	●●●●●	●●●●	●●●●●
AG	●●●	●●●	●●●●	●●●●	●●●	●●●●●	●●●	●●●●●
PRP	●●●	●●●	●●●●	●●●●●	●●●	●●●●●	●●●	●●●●●
P	●●●●	●●●●	●●●●	●●●●●	●●●●	●●●●●	●●●	●●●●●
SM	●●●●	●●●●●	●●●●	●●●	●●●●●	●●●	●●●●●	●●●
ST	●●●●●	●●●●●	●●●●●	●●●	●●●●●	●●●	●●●●●	●●●

FERODO OFF-ROAD materials evaluated under OFF-ROAD conditions

Grading Scale: 1 to 5

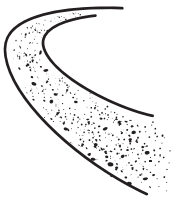

	Friction level	Bite	Fade resistance	Controllability	Pad life dry	Pad life mud
EF	●●	●●	●●	●●●●	●●●	●●
P	●●●	●●●	●●●	●●●●	●●●	●●
SG	●●●●	●●●●	●●●●●	●●●	●●●●●	●●●●●
ZR	●●●●●	●●●●●	●●●●●	●●●●●	●●●●●	●●●●●

COMPARISON CRITERIA

Friction level

Overall average friction coefficient.

Bite

Initial friction at the start of the stop.

Fade Resistance

Resistance to drop-off in friction coefficient under severe braking conditions.

Controllability

How easy the brake is to modulate.

Pad Life

How long the pad lasts

Disc Life

The life of the disc taking into consideration not only the reduction in thickness due to wear, but also maintenance of good surface condition.

Wet Braking

The effectiveness of the material in wet conditions.

Comfort

The amount of brake squeal and other vibration generated during the braking event.

Pad Life in mud

Important for off-road bikes

All test results above are based on various internal and external performance and riding tests including specific personal recommendations by experienced test riders.



DISPLAY UNITS

Free Standing Display



Cod. DIS204

Wall - Mounted Display



Cod. DIS205

Cod.	Dimensions (cm)
DIS204	54x190x45
DIS205	54x96x8,5



ACCESSORIES

FBG001 BRAKE GREASE

FBG001 Ferodo brake grease is a mounting paste based on high viscosity silicon oil, containing also pure natural graphite.

It can help reduce:

VIBRATION

SQUEAL & NOISE

Ferodo brake grease has excellent lubricity and damping properties. By applying to the pad backplate, you can reduce the transmission of friction vibration from the pad to the piston thus reducing brake vibration and squeal.

Each tube contains **50g** of grease



FBA574 BRAKE SHIM

Ferodo FBA574 is a universally applicable anti-noise shim set. Each kit is composed of 4 rubber shims with adhesive (exposed with peel-off paper).

Composition:
3M 468MP
with 200 MP adhesive

Dimensions:
95x60 mm



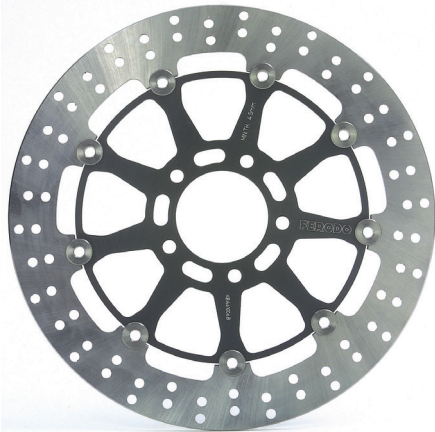



RX

 A full floating disc, alloy carrier, designed to eliminate warping from overheating.

 Flottanti con campana in lega leggera, concepito per eliminare distorsioni derivate da calore. Intercambiabili agli originali.

 Vollschwimmend gelagerte Bremsscheibe mit Aluminiumträger, konstruiert um Verzug durch Überhitzung zu verhindern.

 Disque flottant avec frette centrale en alliage, conçu pour éviter le voilement en cas de surchauffe du disque.

 Disco flotante con campana en aluminio, no "warping". Intercambiable con los discos originales.

 All discs are manufactured with heat treated, high carbon stainless steel that provides:

- Higher friction coefficient
- Improved wear for both disc and brake pad
- Lighter weight
- Increased strength

 Alle Bremsscheiben sind aus Wärme behandeltem Kohlenstoffstahl. Das gewährleistet:

- Einen höheren Reibungskoeffizienten
- Verbesserte Verschleißfestigkeit von Belag und Scheibe
- geringes Gewicht
- Verbesserte Haltbarkeit

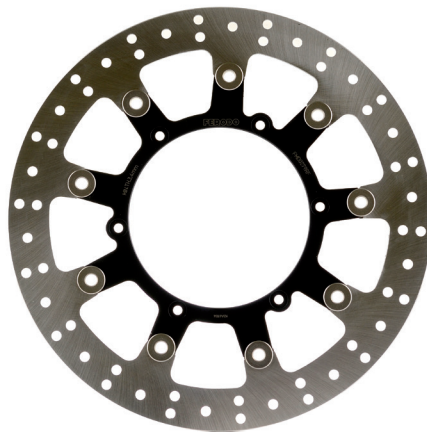



RF

 A full floating disc, steel carrier, designed to eliminate warping from overheating.

 Flottanti con campana in acciaio. Intercambiabili agli originali.

 Vollschwimmend gelagerte Bremsscheibe mit Stahlträger, konstruiert um Verzug durch Überhitzung zu verhindern.

 Disque flottant avec frette centrale en acier, conçu pour éviter le voilement en cas de surchauffe du disque.

 Discos flotantes con campana de acero inoxidable, no "warping". intercambiable con los discos originales.

 Tutti i dischi sono prodotti sono in acciaio con un elevato contenuto di carbonio che garantisce:

- un livello d'attrito più alto
- una ridotta usura delle pastiglie e dello stesso disco
- un minor peso
- maggiore robustezza

 Tous les disques de frein Ferodo sont fabriqués en acier inoxydable à haute teneur en carbone.

- Ils garantissent:
- Un meilleur coefficient de friction
 - Une moindre usure du disque et des plaquettes de frein
 - Un poids minimal
 - Une plus grande robustesse

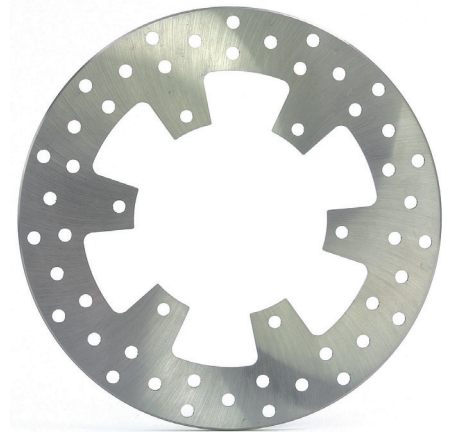



R

 A standard, one piece disc, designed to increase performance and wear over OE.

 Dischi fissi intercambiabili agli originali.

 Einteilige Standardscheibe mit verbesserter Leistung und Haltbarkeit.



 Disque fixe standard en une pièce, conçu pour augmenter et améliorer performance de freinage et usure par rapport au matériau d'origine.

 Disco fijo intercambiable al original, mejor coeficiente de fricción y menor desgaste.

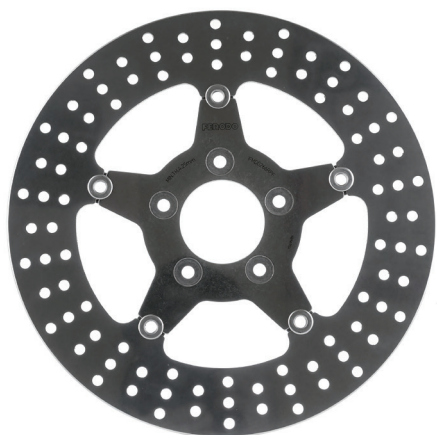
Ferodo discs are the perfect replacement choice.
They are available for your motorcycle in an upgraded version of the OE disc.
The style offered depends on which type of disc was originally specified for your bike.









RPF

-  Disc with steel carrier, designed to achieve minimum "warping", with the additional "polished" treatment providing the high aspect required for a custom bike.
-  Dischi con campana in acciaio concepiti per evitare distorsioni del disco opportunamente lucidati per applicazioni custom.
-  Bremsscheibe mit Stahlträger, um ein Minimum an Verzug zu gewährleisten. Mit polierter Oberfläche für die hochwertige Optik an Ihrem Custom Bike.
-  Disque flottant avec frette centrale en acier, conçu pour éviter le voilement en cas de surchauffe du disque, avec traitement additionnel de polissage, particulièrement recherché pour son aspect brillant requis pour les motos de type "Custom".
-  Discos flotante con campana de acero inox, evita cualquier deformación del disco durante la frenada. Pulido especial indicado para cualquier aplicación custom.



MXR

-  New discs range for motocross applications. Patented dirt expulsion system means braking consistency, even in the muddiest conditions.
-  Nuova gamma dischi per applicazioni motocross. Il sistema di pulizia a fori svasati assicura continuità di frenata, anche in presenza di fango.
-  Das neue Bremsscheiben Programm für den Motocross-Einsatz mit patentiertem Schmutzabweisungs-System. Gewährleistet konstante Bremsleistung auch unter matschigsten Bedingungen.
-  Nouvelle gamme disques pour applications motocross. Le système de propreté aux trous évasés assure continuité de freinage, aussi en présence de boue.
-  Nueva gama de discos de freno para motocross. El sistema patentado de limpieza con agujeros estrechados en el disco preserva la frenada, también en las condiciones más extremas de barro.

-  Todos los discos de freno Ferodo son de acero inoxidable con elevado contenido de carbono que asegura:
 - Elevado coeficiente de fricción
 - Bajo consumo del disco y de la pastilla
 - Material del disco (acero) más ligero y robusto

STANDARD

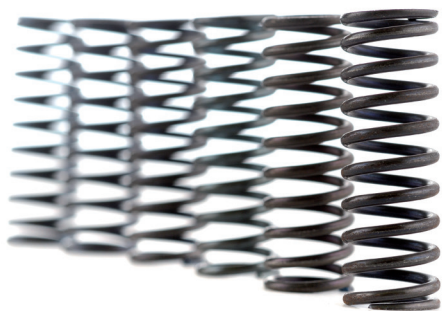

FSS XXXX

-  Spring kits.
-  Kit molle frizione.
-  Feder- kits.
-  Kit de ressorts d'embrayage.
-  Kit muelles embrague.

RACING FRICTION PLATES

The material has unique characteristics that guarantee excellent performance even during the most severe use. The friction material does not contain rubber or cork hence reducing the problem of sticking or slippage.

Ferodo recommend that new friction plates are immersed in engine oil for two hours before use. This allows the material to absorb oil which increases the life of the component.

Note: The racing plates consist of two standard plates that must be mounted one at each end of the clutch set.



FCD XXXX

-  Set of standard friction plates.
-  Dischi frizione conduttori con materiale d'attrito standard.
-  Kupplungs-scheibensätze mit standard-reibmaterial.
-  Série de disques d'embrayages garnis de matériau de friction standard.
-  Serie completa de discos de embrague forrados con material de fricción estándar.

DISCHI FRIZIONE RACING

Il materiale utilizzato possiede caratteristiche uniche che permettono alle frizioni Ferodo di avere performance eccellenti anche nelle condizioni di utilizzo più difficili. Il materiale d'attrito non contiene sughero o gomma, evitando in questo modo qualsiasi problema di incollaggio e slittamento.

Ferodo raccomanda che i nuovi dischi frizione vengano immersi per un paio d'ore in olio motore prima di essere utilizzati. Questo permette al materiale di assorbire una certa quantità d'olio incrementando così la vita del componente.

Nota: la serie dischi conduttori racing comprende due dischi standard che devono essere montati uno all'inizio e l'altro alla fine della serie.

HIGH PERFORMANCE



FCD XXXX/1

-  Set of racing friction plates.
-  Dischi frizione conduttori con materiale d'attrito racing.
-  Racing kupplungs-scheiben mit reibscheiben in rennmaterial.
-  Série de disques d'embrayages garnis de matériau de friction racing.
-  Serie completa de discos de embrague forrados con material de fricción racing.

MOTORSPORT-UPPLUNGSSCHEIBEN

Das verwendete Material gewährleistet auch unter höchster Beanspruchung beste Leistung. Das Reibmaterial beinhaltet weder Kork noch Gummi, dadurch gibt es kein Verkleben und Rutschen.

Ferodo empfiehlt, die neuen Kupplungsringe einige Stunden vor Erstbenutzung in ein Ölbad zu legen. Dadurch kann das Öl ins Material eindringen und steigert die Lebensdauer.





Merke: Der Kupplungs-scheibensatz enthält zwei Standard Ringe, wovon eine am Anfang und eine am Ende des Kupplungs-paketes montiert wird.

Ferodo clutch components are manufactured to the highest European quality standards and utilise only premium quality materials.

STANDARD



FCS XXXX/2

-  Complete sets of steel plates and standard friction plates.
-  Serie completa dischi frizione condotti in acciaio e conduttori con materiale d'attrito standard.
-  Komplette kupplungsätze mit stahlreibrscheiben und reibrscheiben in standardmaterial.
-  Série complète de disques d'embrayages lisses en acier et garnis de matériau de friction standard.
-  Serie completa de discos de embrague forrados con material de fricción estándar y discos en acero inox.

DISQUES D'EMBRAYAGE RACING

Le matériau utilisé possède des caractéristiques uniques qui permettent aux embrayages Ferodo de maintenir d'excellentes performances, même dans les conditions d'utilisation les plus difficiles. Le matériau de friction ne contient ni liège, ni caoutchouc, évitant ainsi toute possibilité de collage et de patinage.



Ferodo recommande que les nouveaux disques soient immergés pendant deux heures dans de l'huile moteur avant d'être utilisés. Ceci permettra au matériau de friction d'absorber une certaine quantité d'huile afin d'augmenter la durée de vie du produit.

Note: La série de disques garnis de matériau de friction racing comprend deux disques standards qui doivent être montés, l'un au début et l'autre à la fin de la série.

HIGH PERFORMANCE



FCS XXXX/3

-  Complete sets of steel plates and racing friction plates.
-  Serie completa dischi frizione condotti in acciaio e conduttori con materiale d'attrito racing.
-  Racing komplette kupplungsätze mit stahlscheiben und reibrscheiben in rennmaterial.
-  Série complète de disques d'embrayages lisses en acier et garnis de matériau de friction racing.
-  Serie completa de discos de embrague forrados con material de fricción racing y discos en acero inox.

DISCOS DE EMBRAGUE RACING

El material utilizado posee características únicas que permiten que los embragues Ferodo tengan unas prestaciones excelentes incluso en las condiciones de utilización mas severas. Los materiales de fricción no contienen ni corcho ni goma, evitando los posibles problemas de despegue o arrastre.





Ferodo recomienda que antes de montar los discos de embrague, se sometan estos a un baño de aceite de motor durante 2 horas aprox. De esta forma el material puede absorber una cierta cantidad de aceite que proporcionará una mayor vida a los discos de embrague.

Nota: La serie de discos de compuesto racing incorporan 2 discos estándar que se deben de montar uno al inicio y otro al final del paquete de embrague.

SCOOTERS



FCG XXXX

-  Complete kits of centrifugal clutches and bells for scooter applications.
-  Kit completo girante frizione e campana per scooter. Assicura il perfetto accoppiamento dei due componenti.
-  Glocken- und fliehkraftkupplung für scooter sichert das perfekte zusammenspiel beider komponenten.
-  Kit complet d'embrayage centrifuge et cloche d'embrayage pour scooters. Assure le parfait accouplement des deux composants.
-  Kit completo de rodillos de fricción y campana para scooter. Asegura el perfecto acoplamiento de los 2 componentes.

FERODO®

BRAKE FLUIDS



All fluids are of Glycol ether based composition, and are suitable for brake and clutch use. Additionally they have the following characteristics:

		DOT4	DOT5.1	Ferodo Formula	Ferodo Super Formula
Technical Details: Typical measured values	Dry boiling point (°C)	248	270	310	328
	Wet boiling point (°C)	159	185	205	200
	Kinematic Viscosity (cSt)	1250	800	1650	1500
Availability	0,25 litre	FBX025	FBZ025	n/a	n/a
	0,50 litre	FBX050	FBZ050	DSF050	FSF050
	1 litre	FBX100	FBZ100	n/a	n/a
	5 litres	n/a	FBZ500	n/a	n/a

Bottles are sold in complete boxes only

	Box = 24 bottles
	Box = 12 bottles
	Box = 4 bottles

WARNING

Recommended for use by experienced mechanics only.

Contains polyalkylene glycol ether and other esters. Keep out of reach of children. Avoid excessive skin contact. If swallowed, seek medical advice and show the container. In case of eye contact, flush with water for 10 minutes.

DOT 4

- Recommended for road use
- Adheres to DOT 4 (and DOT 3) specification
- Low viscosity, low corrosion and low rubber swell
- Available in 3 bottle sizes, including 250ml
- Perfectly suited to motorcycle road use, where peak temperatures do not necessitate more expensive products

DOT 5.1

- Recommended for road use
- Adheres to DOT 5.1 specification
- Very low viscosity means ideally suited for ABS / ESP braking systems
- Low viscosity down to -40°C optimises performance under all conditions
- Available in 4 bottle sizes
- Low corrosion
- Very low rubber swell

FERODO FORMULA

- Recommended for track day & race use
- High wet and dry boiling point
- Low corrosion
- Low rubber swell
- Low viscosity for a race fluid (falls within DOT 4 road spec allowing road use)

FERODO SUPER FORMULA

- Premium Product
- Recommended for race use
- Market leading high wet and dry boiling point
- Very low corrosion, with additives to render more compatible with Mg components
- Low rubber swell
- Super-low viscosity for a race fluid of such high B.pt. (falls within DOT 4 road spec allowing road use)
- Super high lubricity reduces clutch component wear even in problem applications



SUPERIOR PERFORMANCE



DOT 4

Bottles of 250 ml, 500 ml, 1 l

- Perfectly suited to motorcycle road use, where peak temperatures do not necessitate more expensive products
- Adheres to DOT 4 (and DOT 3) specification
- Low viscosity, low corrosion and low rubber swell
- Recommended for road use
- Available in 3 bottle sizes, including 250ml

Technical details

- Dry boiling point: 248 °C
- Wet boiling point: 159 °C
- Kinematic Viscosity (Cst): 1250

www.ferodoracing.com



Equivalent Ferodo Pad Shapes

Shape1	DIMENSIONS		ALSO AVAILABLE						
	Pads*	Length x Height x Thickness	Shape2	Th. mm	Shape 3	Th. mm	Shape 4	Th. mm	Notes2/Notes3/Notes4
FRP405		36.1 x 45.1 x 6.0 mm	FDB2107						with tab
FDB108		56.0 x 55.0 x 9.0 mm	FDB148	7.6					
FDB148		56.0 x 55.0 x 7.6 mm	FDB108	9.0					
FDB244		90.0 x 49.0 x 10.5 mm	FDB538	9.0	FDB665	11.0			
FDB298		68.0 x 41.0 x 9.6 mm	FDB299	8.2					
FDB299		68.0 x 41.0 x 8.2 mm	FDB298	9.6					
FDB381		46.0 x 45.0 x 7.3 mm	FDB661	6.5					
FDB382		81.0 x 42.0 x 7.3 mm	FDB2086	8.3	FDB2119	9.0	FDB2132	8.3	/ / pin on the backplate
FDB383		71.0 x 36.0 x 9.4 mm	FDB475	8.0					
FDB404		77.0 x 54.0 x 7.1 mm	FDB673	9.4					
FDB438		79.0 x 47.0 x 7.4 mm	FDB2060						Material swept depth different
FDB449		74.9 x 54.8 x 10.7 mm	FDB662	8.8					
FDB452		88.1 x 46.1 x 8.5 mm	FDB663	9.8	FDB2173	8.5			/ pin on the backplate
FDB462		81.2 x 42.0 x 8.0 mm	FDB2113	9.5					
FDB475		71.0 x 36.0 x 8.0 mm	FDB383	9.4					
FDB495		94.5 x 32.1 x 7.1 mm	FDB496	10.5					
FDB496		94.5 x 32.1 x 10.6 mm	FDB495	7.0					
FDB497		96.8 x 42.2 x 7.6 / 76.5 x 42.2 x 7.6 mm	FDB631		FDB2305	9			Coupled set /
FDB531		86.2 x 40.5 x 10.6 mm	FDB2258	8.9					
FDB538		90.0 x 49.0 x 9.0 mm	FDB244	10.5	FDB665	11.0			
FDB539		75.1 x 36.1 x 9.7 mm	FDB672	9.1	FDB783	7.6			
FDB570		102.0 x 39.0 x 8.3 mm	FDB664	9.8	FDB2225	10.3	FDB2288	10.5	/ / With Pin
FDB624		35.3 x 51.7 x 7.1 mm	FDB694	6.1					
FDB631		96.8 x 42.2 x 7.6 / 76.5 x 42.2 x 7.6 mm	FDB497		FDB2087	8.8			Coupled set / with slot
FDB637		74.8 x 55.0 x 10.9 mm	FDB666						5 mm Pin Holes
FDB659		62.1 x 40.9 x 9.4 mm	FDB2270	7.1					
FDB661		46.0 x 45.0 x 6.5 mm	FDB381	7.3					
FDB662		74.9 x 54.8 x 8.8 mm	FDB449	10.7					
FDB663		88.1 x 46.1 x 9.8 mm	FDB452	8.5	FDB2173	8.5			/ pin on the backplate
FDB664		102.1 x 39.1 x 9.8 mm	FDB570	8.3	FDB2225	10.3	FDB2288	10.5	/ / With Pin
FDB665		90.0 x 49.0 x 11.5 mm	FDB244	10.0	FDB538	9.0			
FDB666		74.7 x 55.3 x 9.2 mm	FDB637						6 mm Pin Holes
FDB672		75.1 x 36.1 x 9.1 mm	FDB539	9.7	FDB783	7.6			
FDB673		77.0 x 54.0 x 9.4 mm	FDB404	7.1					
FDB694		35.3 x 51.7 x 6.1 mm	FDB624	7.1					
FDB737		104.1 x 46.0 x 10.0 / 88.1 x 46.0 x 10.0 mm	FDB2302	8.25					
FDB783		75.1 x 36.1 x 7.6 mm	FDB539	9.7	FDB672	9.1			
FDB784		31.7 x 51.1 x 5.6 mm	FDB2100	6.0					Different friction material area
FDB873		90.0 x 52.0 x 8.0 mm	FDB2144	9.9					Racing Applications
FDB2007		78.0 x 41.0 x 8.7 mm	FDB2123	10.0					
FDB2018		93.6 x 36.4 x 7.7 mm	FDB2039	8.6 / 10.1					
FDB2039		94.0 x 37.0 x 8.6 / 94.0 x 37.0 x 10.1 mm	FDB2018	7.7					
FDB2040		69.4 x 51.1 x 7.9 mm	FDB2041	11.0					
FDB2041		69.4 x 51.1 x 11.0 mm	FDB2040	7.9					
FDB2048		133.6 x 36.5 x 8.4 / 109.2 x 44.0 x 8.4 mm	FDB2049						Coupled set
FDB2049		133.6 x 36.5 x 8.4 / 109.2 x 44.0 x 8.4 mm	FDB2048						Coupled set
FDB2060		79.1 x 47.3 x 7.6 mm	FDB438						Material swept depth different
FDB2073		115.6 x 41.0 x 8.0 mm	FDB2075	9.4	FDB2098	8.3			
FDB2075		115.6 x 41.0 x 9.4 mm	FDB2073	8.0	FDB2098	8.3			
FDB2079		74.0 x 55.1 x 9.0 mm	FDB2114	7.1					
FDB2080		94.5 x 35.8 x 7.3 / 119.7 x 26.6 x 6.8 mm	FDB2188						Coupled set
FDB2086		81.4 x 42.2 x 8.3 mm	FDB382	7.5	FDB2119	9.0	FDB2132	8.3	/ / pin on the backplate
FDB2087		96.8 x 42.2 x 8.8 / 76.5 x 42.2 x 8.8 mm	FDB631	7.6					Without slot
FDB2098		115.6 x 41.0 x 8.3 mm	FDB2073	8.0	FDB2075	9.4			
FDB2100		31.7 x 51.1 x 6.0 mm	FDB784	5.6					Different friction material area
FDB2107		41.3 x 51.5 x 6.0 mm	FRP405						without tab

Equivalent Ferodo Pad Shapes

Shape1	DIMENSIONS		ALSO AVAILABLE						
	Pads*	Length x Height x Thickness	Shape2	Th. mm	Shape 3	Th. mm	Shape 4	Th. mm	Notes2/Notes3/Notes4
FDB2113		81.2 x 42.0 x 9.5 mm	FDB462	8.0					
FDB2114		74.0 x 55.1 x 7.1 mm	FDB2079	9.0					
FDB2119		81.3 x 42.1 x 9.4 mm	FDB382	7.5	FDB2086	8.0	FDB2132	8.3	/ / pin on the backplate
FDB2120		35.2 x 39.7 x 7.6 mm	FDB2215	8.5	FDB2255	9			Racing Applications / Only for BMW
FDB2123		77.8 x 40.8 x 10.0 mm	FDB2007	8.7					
FDB2126		100.3 x 39.3 x 12.0 mm	FDB2156	9.5					
FDB2132		81.2 x 42.2 x 8.3 mm	FDB382	7.5	FDB2086	8.0	FDB2119	9.0	no pin on the backplate / no pin on the backplate / no pin on the backplate
FDB2133		75.7 x 41.5 x 8.2 / 99.2 x 40.3 x 7.5 mm	FDB2197						Coupled set
FDB2142		97.1 x 41.2 x 9.0 / 77.2 x 41.2 x 9.0 mm	FDB2186						Coupled set
FDB2144		90.0 x 52.0 x 9.9 mm	FDB873	8.0					
FDB2148		82.2 x 40.9 x 9.4 / 62.1 x 40.9 x 9.4 mm	FDB2149		FDB2307	8.3			Coupled set /
FDB2149		82.2 x 40.9 x 9.4 / 62.1 x 40.9 x 9.4 mm	FDB2148		FDB2308	8.3			Coupled set /
FDB2156		100.3 x 39.3 x 9.5 mm	FDB2126	12.0					
FDB2169		111.4 x 36.3 x 7.6 / 98.8 x 33.3 x 7.6 mm	FDB2242						Coupled set
FDB2173		88.0 x 46.0 x 8.5 mm	FDB452	8.5	FDB663	9.8			no pin on the backplate / no pin on the backplate
FDB2178		71.7 x 50.3 x 7.8 mm	FDB2204	9.3					Racing Applications
FDB2181		74.6 x 47.4 x 8.0 mm	FDB2205	9.0					Racing Applications
FDB2186		97.1 x 41.2 x 9.0 / 77.2 x 41.2 x 9.0 mm	FDB2142						Coupled set
FDB2188		94.5 x 35.8 x 7.3 / 119.7 x 26.6 x 6.8 mm	FDB2080						Coupled set
FDB2197		75.7 x 41.5 x 8.2 / 99.2 x 40.2 x 7.5 mm	FDB2133						Coupled set
FDB2204		71.7 x 50.3 x 9.3 mm	FDB2178	7.8					
FDB2205		74.6 x 47.4 x 9.0 mm	FDB2181	8.0					
FDB2215		35.2 x 39.7 x 8.5 mm	FDB2120	7.6	FDB2255	9			Road Version / Only for BMW
FDB2225		102.1 x 39.0 x 10.3 mm	FDB570	8.3	FDB664	9.8	FDB2288	10.5	/ / With Pin
FDB2230		107.4 x 36.7 x 8.0 / 91.7 x 36.5 x 8.0 mm	FDB2231						Coupled set
FDB2231		107.4 x 36.7 x 8.0 / 91.7 x 36.5 x 8.0 mm	FDB2230						Coupled set
FDB2232		107.4 x 36.7 x 9.0 / 91.7 x 36.5 x 9.0 mm	FDB2233						Coupled set
FDB2233		107.4 x 36.7 x 9.0 / 91.7 x 36.5 x 9.0 mm	FDB2232						Coupled set
FDB2242		111.4 x 36.3 x 7.6 / 98.8 x 33.3 x 7.6 mm	FDB2169						Coupled set
FDB2255		35.2 x 39.7 x 9.0 mm	FDB2120	7.6	FDB2215	8.5			Not for BMW / Not for BMW
FDB2258		86.0 x 40.0 x 8.9 mm	FDB531	10.6					
FDB2270		62.1 x 40.9 x 7.1 mm	FDB659	9.4					
FDB2282		85.1 x 44.9 x 7.3 / 74.5 x 41.3 x 7.3 mm	FDB2296	9					
FDB2292		83.2 x 48 x 12 mm	FDB2312	9.2					
FDB2288		102 x 39 x 10.5 mm	FDB570	8.3	FDB664	9.8	FDB2225	10.3	Without Pin / Without Pin / Without Pin
FDB2289		85.1 x 44.9 x 7.3 / 74.5 x 41.3 x 7.3 mm	FDB2297	9					
FDB2296		85.1 x 44.9 x 9 / 74.5 x 41.3 x 9 mm	FDB2282	7.3					
FDB2297		85.1 x 44.9 x 9 / 74.5 x 41.3 x 9 mm	FDB2289	7.3					
FDB2301		104.1 x 46 x 8.25 / 88.1 x 46 x 8.25 mm	FDB2302						Coupled sets
FDB2302		104.1 x 46 x 8.25 / 88.1 x 46 x 8.25 mm	FDB737	10	FDB2301				/ Coupled sets
FDB2307		82.2 x 40.9 x 8.3 / 62.1 x 40.9 x 8.3 mm	FDB2148	9.4	FDB2308				/ Coupled set
FDB2308		82.2 x 40.9 x 8.3 / 62.1 x 40.9 x 8.3 mm	FDB2149	9.4	FDB2307				/ Coupled set
FDB2305		98.6 x 42.2 x 9 / 76.5 x 42.2 x 9 mm	FDB497	7.6					
FDB2312		83.2 x 48 x 9.2 mm	FDB2292	12					Without pin



FERODO[®]

PADS & SHOES

**MOTORCYCLE
APPLICATIONS**



FERODO[®]

MOTORCYCLE



CC KW FROM -> TO N° SET L/R COMPOUND N° SET L/R COMPOUND

ACCOSSATO

CE 50	50	1987 →	FDB207			ST/P/EF/CP1	FDB697		EF
CR 50 CROSS COMPETIZIONE	50	1984 →	FSB898				FSB898		
CR 50 ENDURO	50	1984 →	FSB898				FSB898		
CR 50 ENDURO COMPETIZIONE	50	1984 →	FSB898				FSB898		
50 CROSS MINI	50	1982 →	FSB907				FSB907		
50 CROSS	50	1983 →	FSB898				FSB898		
50 ENDURO CODICE	50	1989 →	FDB207			ST/P/EF/CP1	FDB697		EF
CE 80 CROSS H 20	80	1984 →	FSB904				FSB898		
CE 80 ENDURO H 20	80	1984 →	FSB904				FSB898		
CE 80	80	1987 →	FDB207			ST/P/EF/CP1	FDB207		ST/P/EF/CP1
80 CROSS	80	1983 →	FSB898				FSB898		
KR 80	80	1987 →	FDB207			ST/P/EF/CP1	FDB697		EF
CE 125 CROSS H 20	125	1984 →	FSB904				FSB898		
CE 125 ENDURO H 20	125	1984 →	FSB904				FSB898		

ADIVA

AD 125	125	2009 → 2011	FDB2190			EF	FDB2003		ST/SM/P/EF
AR 125	125	2010 → 2011	FDB2190			EF	FDB2003		ST/SM/P/EF
AD 200	200	2009 → 2011	FDB2190			EF	FDB2003		ST/SM/P/EF
AR 200	200	2010 → 2011	FDB2190			EF	FDB2003		ST/SM/P/EF
AD 400	400	2009 → 2011	FDB2074	2		ST/SM/P/EF/CPRO/AG	FDB2074		ST/SM/P/EF/CPRO/AG

ADLY

Cat 50	50	1998 →	FDB313			SG/P/EF	FSB731		
Fox 50 / SILVER FOX 50	50	2000 →	FDB383			SG/P/EF	FSB731		
G-Shock 50	50	1998 →	FDB313			SG/P/EF	FSB731		
Jet 50	50	1996 →	FDB636			P/EF	FSB731		
Pista 50	50	1996 →	FDB636			P/EF	FSB731		
Predator 50	50	2000 →	FDB636			P/EF	FSB731		
Super Sonic 50	50	2000 →	FDB313			SG/P/EF	FSB731		
Thunderbike 50	50	1997 →	FDB313			SG/P/EF	FSB731		
Cat 100	100	1998 →	FDB313			SG/P/EF	FSB731		
G-Shock 100	100	1998 →	FDB313			SG/P/EF	FSB731		
Jet 100	100	1996 →	FDB636			P/EF	FSB731		
Predator 100	100	2000 →	FDB636			P/EF	FSB731		
Cat 125	125	1998 →	FDB313			SG/P/EF	FSB731		

AEON

Urban 125	125	2011 → 2013	FDB2305			EF			
Elite 125	125	2013 →	FDB2305			EF			
Elite 250	250	2011 →	FDB2305			EF			
Urban 350	350	2011 →	FDB2305			EF			
Elite 400i (ABS)	400	2014 →	FDB2291			EF			

AJP

PR3 125 Enduro	125	2008 → 2012	FDB677			P/EF	FDB2109		P
PR3 125 Enduro	125	2013 → 2015	FDB2242			P/EF			
PR3 125 Enduro Pro	125	2008 → 2012	FDB677			P/EF	FDB2109		P
PR3 125 Enduro Pro	125	2013 → 2015	FDB2242			P/EF			
PR3 125 Extreme	125	2013 → 2015	FDB2242			P/EF			
PR3 125 Supermoto	125	2008 → 2012	FDB677			P/EF	FDB2109		P
PR3 125 Supermoto	125	2013 → 2015	FDB2242			P/EF			
PR3 125 Supermoto Pro	125	2010 → 2011	FDB677			P/EF	FDB2109		P
PR3 125 Trial	125	2011 → 2012	FDB677			P/EF	FDB2109		P
PR4 Enduro 125	125	2004 → 2009	FDB706			P	FDB2109		P
PR4 Enduro 125	125	2010 → 2012	FDB677			P/EF	FDB384		P
PR4 Enduro 125	125	2013 → 2015	FDB2242			P/EF			
PR4 Enduro Pro 125	125	2010 → 2012	FDB677			P/EF	FDB384		P
PR4 Enduro Pro 125	125	2013 → 2015	FDB2242			P/EF			
PR4 Supermoto 125	125	2004 → 2009	FDB706			P	FDB2109		P
PR4 Supermoto 125	125	2010 → 2012	FDB677			P/EF	FDB384		P
PR4 Supermoto 125	125	2013 → 2015	FDB2242			P/EF			
PR4 Supermoto Pro 125	125	2010 → 2011	FDB677			P/EF	FDB384		P
PR4 125 Trial	125	2013 → 2015	FDB2242			P/EF			
PR3 200 Enduro	200	2008 → 2011	FDB677			P/EF	FDB2109		P
PR3 200 Enduro	200	2012 → 2014	FDB677			P/EF			
PR3 200 Enduro Pro	200	2010 → 2011	FDB677			P/EF	FDB2109		P

* It is recommended that in those applications where sintered pads are supplied as Original Equipment, replacement pads should also be of sintered composition.

** To avoid brake imbalance sintered pads fitted in rear calipers should only be used in combination with front calipers containing sintered pads.

1000



	CC	KW	FROM -> TO	N° SET	L/R	COMPOUND	N° SET	L/R	COMPOUND
...AJP									
PR3 200 Enduro Pro	200		2012 → 2014	FDB677		P/EF			
PR3 200 M/X	200		2010 → 2011	FDB677		P/EF	FDB2109		P
PR3 200 M/X Pro	200		2010 → 2011	FDB677		P/EF	FDB2109		P
PR3 200 M/X Pro	200		2012 → 2014	FDB677		P/EF			
PR3 200 Supermotard Pro	200		2010 → 2011	FDB677		P/EF	FDB2109		P
PR3 200 Supermoto	200		2008 → 2011	FDB677		P/EF	FDB2109		P
PR3 200 Supermoto	200		2012 → 2014	FDB677		P/EF			
PR4 200 Supermoto Pro	200		2010 → 2011	FDB677		P/EF	FDB384		P
PR4 Enduro 200	200		2004 → 2009	FDB706		P	FDB2109		P
PR4 Enduro 200	200		2010 → 2011	FDB677		P/EF	FDB384		P
PR4 Enduro 200	200		2012 → 2014	FDB677		P/EF			
PR4 Enduro Pro 200	200		2010 → 2011	FDB677		P/EF	FDB384		P
PR4 Enduro Pro 200	200		2012 → 2014	FDB677		P/EF			
PR4 200 Extreme	200		2012 → 2014	FDB677		P/EF			
PR4 200 Supermoto	200		2004 → 2009	FDB706		P	FDB2109		P
PR4 200 Supermoto	200		2010 → 2011	FDB677		P/EF	FDB384		P
PR4 200 Supermoto	200		2012 → 2014	FDB677		P/EF			
PR3 240 M/X Pro	240		2013 → 2015	FDB2242		P/EF			
PR4 240 Extreme	240		2013 → 2015	FDB2242		P/EF			
PR5 250 Enduro	250		2009 → 2009	FDB892		ZR/SG/P/EF/CPRO	FDB539		SG/P/EF
PR5 250 Enduro	250		2010 → 2015	FDB2242		P/EF			
PR5 250 Extreme	250		2012 → 2015	FDB2242		P/EF			
PR5 250 Supermoto	250		2009 → 2009	FDB892		ZR/SG/P/EF/CPRO	FDB539		SG/P/EF
PR5 250 Supermoto	250		2010 → 2015	FDB2242		P/EF			
AKT									
Flex Ultra			→	FDB2087		EF			
AK 100 S	100		→	FDB250		SG/P/EF			
AK 110	110		→	FDB312		ST/P/EF			
Komfort	115		→	FDB2083		ST/SM/P/EF			
AK 125 Dynamic	125		→	FDB2190		EF			
AK 125 EVO	125		→	FDB497		ST/SM/SG/P/EF			
AK 125 Flex	125		→	FDB2169		P/EF			
AK 125 PRO	125		→	FDB2190		EF			
AK 125 R3	125		→	FDB2087		EF			
AK 125 S	125		→	FDB312		ST/P/EF			
AK 125 SL	125		→	FDB312		ST/P/EF			
AK 125 TT	125		→	FDB312		ST/P/EF			
TT 125	125		→	FDB2087		EF			
TTR 125	125		→	FDB497		ST/SM/SG/P/EF			
AK 150 EVO	150		→	FDB497		ST/SM/SG/P/EF			
AK 150 R3	150		→	FDB2087		EF			
RTX 150	150		→	FDB497		ST/SM/SG/P/EF	FDB2258		ST/EF
TT 150	150		→	FDB2087		EF			
TTR 150	150		→	FDB497		ST/SM/SG/P/EF			
AK 180 XM	180		→	FDB250		SG/P/EF			
CR5	180		→	FDB2087		EF			
TTR 180	180		→				FDB2286		EF
TTX 180	180		→				FDB2286		EF
XM	180		→	FDB497		ST/SM/SG/P/EF			
AK 200 XM	200		→				FDB250		SG/P/EF
XM	200		→	FDB497		ST/SM/SG/P/EF			
AK 235 R	235		→				FDB2087		EF
AK 250 Adventour	250		→				FDB2258		ST/EF
ALFER									
MC 80	80		1988 →	FDB207		ST/P/EF/CP1	FDB2107		P
MC 80 CROSS	80		1989 →	FDB207		ST/P/EF/CP1	FDB207		ST/P/EF/CP1
MC 125	125		1987 → 1987	FDB207		ST/P/EF/CP1	FDB207		ST/P/EF/CP1
MC 125	125		1988 →	FDB498		XRAC/ST/P	FDB207		ST/P/EF/CP1
AR 250	250		1992 → 1992	FDB499		P	FDB314		ST/SG/P/EF
AR 250	250		1993 →	FDB2018		ZR/ST/SG/P/EF	FDB314		ST/SG/P/EF
GR 250 ENDURO	250		1985 → 1987	FDB207		ST/P/EF/CP1	FDB207		ST/P/EF/CP1
GR 250 ENDURO	250		1988 →	FDB498		XRAC/ST/P	FDB207		ST/P/EF/CP1
MC 250	250		1985 → 1986	FDB207		ST/P/EF/CP1			
MC 250	250		1987 → 1987	FDB207		ST/P/EF/CP1	FDB207		ST/P/EF/CP1
MC 250	250		1988 →	FDB498		XRAC/ST/P	FDB207		ST/P/EF/CP1
NO LIMITS 250	250		1995 →	FDB2018		ZR/ST/SG/P/EF	FDB2005		ST/SG/P/EF
VR 250	250		1994 →	FDB2018		ZR/ST/SG/P/EF	FDB314		ST/SG/P/EF
VR 250 ENDURO	250		1995 →	FDB2018		ZR/ST/SG/P/EF	FDB2005		ST/SG/P/EF

* It is recommended that in those applications where sintered pads are supplied as Original Equipment, replacement pads should also be of sintered composition.

** To avoid brake imbalance sintered pads fitted in rear calipers should only be used in combination with front calipers containing sintered pads.



CC KW FROM -> TO



N° SET L/R COMPOUND



N° SET L/R COMPOUND

ALFER

VR 250 MOTOCROSS	250	1995 →	FDB2018			ZR/ST/SG/P/EF	FDB2005			ST/SG/P/EF
VR 250 SUPERMOTARD	250	1999 →	FDB2018			ZR/ST/SG/P/EF	FDB2005			ST/SG/P/EF
GR 300 ENDURO	300	1985 → 1987	FDB207			ST/P/EF/CP1	FDB207			ST/P/EF/CP1
GR 300 ENDURO	300	1989 →	FDB499			P	FDB498			XRAC/ST/P
TX 300	300	1990 →	FDB2107			P	FDB207			ST/P/EF/CP1

ANCILLOTTI

PS 80 MX	80	1983 →	FSB898				FSB898			
PST 125 MX	125	1983 →	FSB898				FSB898			
PSV 250 MX	250	1983 →	FSB898				FSB901			

APRILIA

AF1 50 AE all models	50	1987 →	FDB697			EF	FDB694			ST/AG
AF1 50 FUTURA	50	1990 →	FDB697			EF	FDB694			ST/AG
AF1 50 EUROPA	50	1991 →	FDB697			EF	FDB694			ST/AG
AMICO 50	50	1990 → 1991	FSB704				FSB704			
AMICO 50 all models	50	1992 →	FDB680			ST/EF	FSB704			
AREA 51 50	50	1998 →	FDB680			ST/EF	FDB680			ST/EF
CLASSIC 50	50	1992 →	FDB677			P/EF				
ET 50	50	1984 → 1986	FSB907							
ET 50 AE	50	4 1987 →	FDB697			EF	FDB694			ST/AG
ET 50	50	3 1988 →	FDB697			EF	FDB694			ST/AG
ETX 50	50	1986 →	FDB697			EF				
GULLIVER 50	50	1995 → 1998	FDB680			ST/EF	FSB704			
HABANA 50 all models	50	1998 →	FDB680			ST/EF	FSB956			
MOJITO CUSTOM 50	50	1999 → 2003	FDB680			ST/EF	FSB956			
MOJITO CUSTOM 50	50	2004 → 2012	FDB680			ST/EF	FSB938			
MX 50	50	1976 → 1982	FSB898				FSB898			
MX 50	50	2002 → 2004	FDB677			P/EF	FDB694			ST/AG
RALLY 50 air cooled	50	1995 → 2002	FDB680			ST/EF	FSB704			
RALLY 50 liquid cooled	50	1996 → 2000	FDB680			ST/EF	FDB680			ST/EF
RC 50	50	→ 1983	FSB907				FSB907			
RC 50 SPECIAL	50	→ 1983	FSB898				FSB898			
RED ROSE 50	50	1988 → 1991	FDB697			EF	FSB907			
RED ROSE 50	50	1992 →	FDB697			EF				
RS 50	50	1993 → 1998	FDB207			ST/P/EF/CP1	FDB694			ST/AG
RS 50	50	1999 → 2005	FDB677			P/EF	FDB694			ST/AG
RS 50	50	2006 → 2011	FDB2074			ST/SM/P/EF/CPRO/AG	FRP405			ST/SG/PRP/P/EF
RS4 50 (AJP caliper)	50	2011 →	FDB2201			ST	FDB384			P
RS4 50 (JJ caliper)	50	2011 →	FDB2201			ST	FDB313			SG/P/EF
RX 50	50	1989 → 1991	FDB697			EF	FDB694			ST/AG
RX 50	50	1992 → 1995	FDB677			P/EF	FDB624			AG
RX 50	50	1996 → 1998	FDB207			ST/P/EF/CP1	FDB624			AG
RX 50	50	2003 → 2014	FDB706			P	FRP405			ST/SG/PRP/P/EF
RX 50 RACING	50	2003 → 2007	FDB677			P/EF	FDB694			ST/AG
RX 50 Enduro	50	1995 → 2003	FDB706			P	FRP405			ST/SG/PRP/P/EF
SCARABEO 50	50	1994 → 1995	FSB939				FSB704			
SCARABEO 50 / 50 Street 4T-2T	50	1996 →	FDB680			ST/EF	FSB704			
SCARABEO 50 DELUXE	50	1998 →	FDB680			ST/EF	FDB680			ST/EF
SCARABEO 50 2T Street / 4T 4V	50	2010 →	FDB731			P	FSB954			
SONIC 50 GP	50	1997 →	FDB680			ST/EF	FSB704			
SONIC 50 SPICE	50	1997 →	FDB680			ST/EF	FSB704			
Sport City One 50 (2T)	50	2008 → 2011	FDB2142			ST/SM/EF/AG	FSB954			
Sport City One 50 (4T)	50	2008 → 2009	FDB2142			ST/SM/EF/AG	FSB954			
SR 50 all models	50	1993 → 1996	FDB889			ST/EF	FSB704			
SR 50 STEALTH - RACING	50	1997 → 1999	FDB680			ST/EF	FDB680			ST/EF
SR 50 WWW - NETSCAPER	50	1997 → 2001	FDB680			ST/EF	FDB680			ST/EF
SR 50 2000	50	2000 →	FDB680			ST/EF	FDB2090			P/EF
SR STREET 50	50	2003 →	FDB680			ST/EF	FDB2090			P/EF
SR 50 FACTORY	50	2004 →	FDB680			ST/EF	FDB2090			P/EF
SR 50 R	50	2008 →	FDB2090			P/EF	FDB2090			P/EF
SR MOTARD 50	50	2012 →	FDB2142			ST/SM/EF/AG	FSB954			
SX 50	50	2007 → 2008	FDB677			P/EF	FDB694			ST/AG
SX 50	50	2008 → 2013	FDB677			P/EF	FRP405			ST/SG/PRP/P/EF
SX 50 Ltd.	50	2014 →	FDB497			ST/SM/SG/P/EF	FDB313			SG/P/EF
TUAREG 50	50	1984 → 1986	FSB907							
TUAREG 50	50	1987 →	FDB697			EF	FDB624			AG
TUAREG 50 HPC SYSTEM	50	1987 →	FDB438			P/EF	FDB207			ST/P/EF/CP1
TUAREG 50 RALLY	50	1990 →	FDB697			EF	FDB694			ST/AG
TUONO 50	50	2003 → 2004	FDB677			P/EF	FDB207			ST/P/EF/CP1

* It is recommended that in those applications where sintered pads are supplied as Original Equipment, replacement pads should also be of sintered composition.

** To avoid brake imbalance sintered pads fitted in rear calipers should only be used in combination with front calipers containing sintered pads.

1002**FERODO**

RACING

Updated on November 2020



	CC	KW	FROM -> TO		N° SET	L/R	COMPOUND		N° SET	L/R	COMPOUND
...APRILIA											
CLASSIC 80	80		1993 →	FDB697			EF				
SCARABEO 100 (Minarelli engine)	100		2000 →	FDB2095			EF	FSB733			
SCARABEO 100 (Yamaha engine)	100		2000 →	FDB2095			EF	FSB947			
SCARABEO 100 4T	100		2001 → 2004	FDB2095			EF	FSB954			
SCARABEO 100 Net	100		2010 →	FDB2095			EF				
AF1 125	125		1987 →	FDB499			P	FDB207			ST/P/EF/CP1
AF1 125 REPLICIA	125		1989 → 1991	FDB498			XRAC/ST/P	FDB207			ST/P/EF/CP1
AF1 125 SINTESI	125		1989 → 1991	FDB498			XRAC/ST/P	FDB207			ST/P/EF/CP1
AF1 125 EUROPA	125		1990 → 1991	FDB498			XRAC/ST/P	FDB207			ST/P/EF/CP1
AF1 125 FUTURA	125		1990 → 1991	FDB498			XRAC/ST/P	FDB207			ST/P/EF/CP1
AF1 FUTURA SPORT PRO 125	125		1993 → 2003	FDB498			XRAC/ST/P	FDB207			ST/P/EF/CP1
ATLANTIC (ARECIFE) 125	125		2003 →	FDB2105			EF/AG	FDB2090			P/EF
ATLANTIC 125	125		2010 →	FDB2105			EF/AG	FDB2090			P/EF
CLASSIC 125	125		1996 →	FDB706			P	FDB207			ST/P/EF/CP1
ETX 125	125		1984 →					FSB876			
ETX 125	125		1985 → 1986	FDB207			ST/P/EF/CP1	FSB909			
ETX 125	125		1986 → 1997	FDB438			P/EF	FSB909			
ETX 125	125		1998 →	FDB677			P/EF	FDB828			ST/P
HABANA 125 all models	125		1999 →	FDB2095			EF	FSB954			
LEONARDO 125	125		1995 → 1996	FDB207			ST/P/EF/CP1	FDB680			ST/EF
LEONARDO 125	125		1997 → 1998	FDB2081			AG	FDB680			ST/EF
LEONARDO 125	125		1999 → 2006	FDB2095			EF	FDB2095			EF
MOJITO CUSTOM 125	125		2004 →	FDB680			ST/EF				
MX 125	125		1977 → 1985	FSB898				FSB901			
MX 125	125		2004 → 2006	FDB2018			ZR/ST/SG/P/EF	FDB828			ST/P
PEGASO 125	125		1989 →	FDB706			P	FDB828			ST/P
PEGASO 125 KAT	125		1994 →	FDB677			P/EF	FDB828			ST/P
RED ROSE 125	125		1989 → 1989	FDB438			P/EF	FSB876			
RED ROSE 125	125		1990 →	FDB706			P	FSB876			
RS 125 EXTREMA - REPLICIA	125		1993 → 1997	FDB498			XRAC/ST/P	FDB207			ST/P/EF/CP1
RS 125	125		1998 → 1999	FDB2006			ST/P/EF	FDB207			ST/P/EF/CP1
RS 125	125		2000 → 2003	FDB498			XRAC/ST/P	FDB207			ST/P/EF/CP1
RS 125	125		2004 → 2006	FDB498			XRAC/ST/P	FDB207			ST/P/EF/CP1
RS 125 2T RADIAL CALIPER	125		2006 → 2012	FDB2216			ST/SM/P/CP1	FDB2090			P/EF
RS	125		2017 →	FDB2201			ST	FDB313			SG/P/EF
RS4 125 4T (AJP caliper)	125		2011 →	FDB2201			ST	FDB384			P
RS4 125 4T (JJ caliper)	125		2011 →	FDB2201			ST	FDB313			SG/P/EF
RS4 125 4T SBK Replica (JJ caliper)	125		2015 →	FDB2201			ST	FDB313			SG/P/EF
RX 125 (Rimoldi wheels)	125		1984 → 1985	FSB898							
RX 125	125		1985 → 1989	FDB438			P/EF	FSB909			
RX 125	125		1990 → 1991	FDB706			P	FDB828			ST/P
RX 125	125		1992 → 1994	FDB677			P/EF	FDB828			ST/P
RX 125	125		1995 → 2002	FDB2018			ZR/ST/SG/P/EF	FDB828			ST/P
RX 125 (AJP Caliper F&R)	125		2008 → 2013	FDB2018			ZR/ST/SG/P/EF	FDB384			P
RX 125 (Brembo Front & Grimeca Rear)	125		2008 → 2013	FDB2018			ZR/ST/SG/P/EF	FDB314			ST/SG/P/EF
RX 125	125		2019 →	FDB497			ST/SM/SG/P/EF	FDB313			SG/P/EF
SCARABEO 125	125		1998 → 2006	FDB438			P/EF	FDB2090			P/EF
SCARABEO 125 Street	125		2007 →	FDB2105			EF/AG	FDB2090			P/EF
SCARABEO 125 GT	125		2002 → 2003	FDB438			P/EF	FDB2090			P/EF
SCARABEO 125 GT	125		2004 →	FDB2105			EF/AG	FDB2090			P/EF
SPORTCITY 125 ie	125		2004 →	FDB438			P/EF	FDB2090			P/EF
Sport City Cube 125	125		2008 → 2012	FDB2060			P/AG	FDB2090			P/EF
SPORTCITY ONE 125	125		2010 →	FDB2142			ST/SM/EF/AG	FSB954			
SR 125	125		1999 → 2002	FDB2095			EF	FSB954			
SR MAX 125	125		2011 →	FDB2142			ST/SM/EF/AG	FDB2142			ST/SM/EF/AG
SR MOTARD 125	125		2012 →	FDB2142			ST/SM/EF/AG	FSB954			
ST 125	125		1987 →	FDB204			P	FSB876			
STX 125	125		1984 →					FSB876			
STX 125	125		1986 →	FDB204			P	FSB876			
SX 125	125		2008 → 2017	FDB2018			ZR/ST/SG/P/EF	FDB828			ST/P
SX 125	125		2018 →	FDB2142			ST/SM/EF/AG	FDB313			SG/P/EF
TUAREG 125	125		1984 →	FSB904				FSB909			
TUAREG 125	125		1986 →	FDB438			P/EF	FDB207			ST/P/EF/CP1
TUAREG 125 RALLY	125		1986 →	FDB438			P/EF	FSB909			
TUAREG 125 RALLY (Mozzi Rimoldi)	125		1986 →	FDB438			P/EF	FSB834			
TUAREG 125	125		1987 →	FDB438			P/EF	FDB207			ST/P/EF/CP1
TUAREG 125 RALLY	125		1989 → 1990	FDB706			P	FDB828			ST/P
TUAREG 125 WIND	125		1990 →	FDB529			P	FDB207			ST/P/EF/CP1
TUAREG 125 RALLY	125		1991 →	FDB673			P	FDB828			ST/P
TUONO 125 2T	125		2003 → 2004	FDB498			XRAC/ST/P	FDB207			ST/P/EF/CP1
TUONO 125 4T	125		2017 →	FDB2201			ST	FDB313			SG/P/EF
TX 125	125		1985 →	FSB898				FSB898			
TX 125 M	125		1986 →	FRP405			ST/SG/PRP/P/EF	FSB898			
LEONARDO	150		1997 → 1998	FDB2081			AG	FDB680			ST/EF

* It is recommended that in those applications where sintered pads are supplied as Original Equipment, replacement pads should also be of sintered composition.

** To avoid brake imbalance sintered pads fitted in rear calipers should only be used in combination with front calipers containing sintered pads.



CC KW FROM -> TO N° SET L/R COMPOUND N° SET L/R COMPOUND

...APRILIA

LEONARDO	150	1999	→	2004	FDB2095			EF	FDB2095		EF
SCARABEO 150	150	1998	→		FDB438			P/EF	FDB2090		P/EF
SCARABEO 150 GT	150	2004	→		FDB677			P/EF	FDB2090		P/EF
SR 150	150	1999	→	2002	FDB2095			EF	FSB954		
ATLANTIC (ARECIFE) 200	200	2003	→	2007	FDB2105			EF/AG	FDB2090		P/EF
CLIMBER 200	200	1993	→		FDB207			ST/P/EF/CP1	FDB207		ST/P/EF/CP1
SCARABEO 200	200	2001	→	2007	FDB438			P/EF	FDB2090		P/EF
SCARABEO 200 GT	200	2002	→		FDB438			P/EF	FDB2090		P/EF
SCARABEO 200 / Class	200	2008	→		FDB2105			EF/AG	FDB2090		P/EF
SCARABEO 200 i.e.	200	2009	→		FDB2105			EF/AG	FDB2090		P/EF
SPORTCITY 200	200	2004	→		FDB438			P/EF	FDB2090		P/EF
Sport City Cube 200	200	2008	→	2009	FDB2060			P/AG	FDB2090		P/EF
CLIMBER 240	240	1989	→	1990	FDB697			EF	FDB694		ST/AG
TRX 240 M	240	1989	→		FDB697			EF	FDB697		EF
TX 240	240	1985	→		FSB898				FSB898		
AF1 250 REPLICA	250	1990	→		FDB498			XRAC/ST/P	FDB108		ST/P/EF/CPRO
ATLANTIC 250	250	2008	→		FDB2105			EF/AG	FDB2090		P/EF
LEONARDO 250	250	1999	→		FDB438			P/EF	FDB2090		P/EF
MX 250	250	1980	→	1982	FSB901				FSB901		
MX 250	250	1983	→	1983	FDB207			ST/P/EF/CP1	FSB901		
MX 250	250	1984	→	1985	FSB904				FSB904		
RS 250	250	1995	→	1996	FRP408	2		XRAC/ST/PRP/P/CPRO/CP1	FDB207		ST/P/EF/CP1
RS 250	250	1997	→	1998	FRP408	2		XRAC/ST/PRP/P/CPRO/CP1	FDB680		ST/EF
RS 250	250	1998	→		FDB2042	2		ZRAC/XRAC/ST/P/EF/CPRO	FDB207		ST/P/EF/CP1
RX 250	250		→	1983	FSB901				FSB901		
RX 250	250	1983	→		FDB207			ST/P/EF/CP1			
RX 250	250	1984	→		FSB904				FSB904		
RX 250	250	1986	→		FDB207			ST/P/EF/CP1	FSB909		
SCARABEO 250	250	2004	→	2006	FDB2105			EF/AG	FDB2090		P/EF
SCARABEO 250 ie	250	2007	→		FDB2105			EF/AG	FDB2090		P/EF
SPORTCITY 250 ie	250	2007	→		FDB438	2		P/EF	FDB2090		P/EF
TUAREG 250	250	1984	→						FSB911		
TUAREG 250 RALLY	250	1986	→		FDB438			P/EF	FSB909		
TUAREG 250 RALLY (Mozzi Rimoldi)	250	1986	→		FDB438			P/EF	FSB834		
CLIMBER 275	275	1989	→	1992	FDB697			EF	FDB694		ST/AG
CLIMBER 280	280	1993	→		FDB2107			P	FDB2107		P
ATLANTIC 300	300	2010	→		FDB2105			EF/AG	FDB2090		P/EF
LEONARDO 300	300	2004	→		FDB438			P/EF	FDB2090		P/EF
SCARABEO 300 Class / Special	300	2010	→		FDB2105			EF/AG	FDB2090		P/EF
SPORTCITY 300 / Cube Black line	300	2008	→		FDB438	2		P/EF	FDB2090		P/EF
SR MAX 300	300	2011	→		FDB2142			ST/SM/EF/AG	FDB2142		ST/SM/EF/AG
TX 300	300	1985	→		FSB898				FSB898		
TX 300	300	1986	→		FRP405			ST/SG/PRP/P/EF	FSB898		
TX 300 M	300	1986	→		FRP405			ST/SG/PRP/P/EF	FSB898		
TX 311 M	312	1987	→		FRP405			ST/SG/PRP/P/EF	FSB898		
TX 312 M	312	1988	→		FRP405			ST/SG/PRP/P/EF	FRP405		ST/SG/PRP/P/EF
TXR 312 M	312	1988	→		FRP405			ST/SG/PRP/P/EF	FRP405		ST/SG/PRP/P/EF
TRIAL 320	320	1981	→		FSB898				FSB898		
ETX 350	350	1986	→		FDB438			P/EF	FDB207		ST/P/EF/CP1
ETX 350 AE	350	1987	→		FDB438			P/EF	FDB207		ST/P/EF/CP1
TUAREG 350	350	1987	→		FDB438			P/EF	FDB207		ST/P/EF/CP1
TUAREG 350 WIND	350	1987	→	1988	FDB438			P/EF	FDB207		ST/P/EF/CP1
TUAREG 350 WIND	350	1989	→		FDB499			P	FDB314		ST/SG/P/EF
TUAREG 350 WIND	350	1990	→		FDB529			P	FDB314		ST/SG/P/EF
ATLANTIC Sprint 400	400	2007	→		FDB2105			EF/AG	FDB2090		P/EF
SCARABEO 400 ie	400	2007	→		FDB438	2		P/EF	FDB2090		P/EF
MXV 450	450	2008	→		FDB892			ZR/SG/P/EF/CPRO	FDB2139		SG/P/EF
RXV 450 / Rally / Merriman Replica	450	2005	→		FDB892			ZR/SG/P/EF/CPRO	FDB2162		SG/P/EF
SXV 450	450	2005	→	2007	FDB2245			ST	FDB2162		SG/P/EF
SXV VDB Replica	450	2007	→	2007	FDB2007			CPRO/CP1	FDB2162		SG/P/EF
ATLANTIC (ARECIFE) 500	500	2001	→		FDB438		left	P/EF			
ATLANTIC (ARECIFE) 500	500	2001	→		FDB2146		right	P			
ATLANTIC (ARECIFE) 500	500	2001	→						FDB2090		P/EF
ATLANTIC Sprint 500	500	2007	→		FDB2105			EF/AG	FDB2090		P/EF
SCARABEO 500	500	2003	→		FDB2060	2		P/AG	FDB2090		P/EF
SCARABEO 500	500	2008	→		FDB438	2		P/EF	FDB2090		P/EF
SCARABEO 500 Class	500	2010	→		FDB438	2		P/EF	FDB2090		P/EF
RXV 550	550	2005	→		FDB892			ZR/SG/P/EF/CPRO	FDB2162		SG/P/EF
SXV 550	550	2005	→		FDB2245			ST	FDB2162		SG/P/EF
SXV VDB Replica	550	2007	→	2007	FDB2007			CPRO/CP1	FDB2162		SG/P/EF
ETX 600	600	1986	→		FDB438			P/EF	FDB207		ST/P/EF/CP1
PEGASO 600	600	1990	→		FDB2006			ST/P/EF	FDB828		ST/P
TUAREG 600 WIND	600	34	1988	→	1990	FDB529	2	P	FDB828		ST/P
TUAREG 600 WIND (Twin discs)	600	34	1988	→	1990	FDB314	2	ST/SG/P/EF	FDB314		ST/SG/P/EF

* It is recommended that in those applications where sintered pads are supplied as Original Equipment, replacement pads should also be of sintered composition.

** To avoid brake imbalance sintered pads fitted in rear calipers should only be used in combination with front calipers containing sintered pads.

1004

APRILIA



	CC	KW	FROM -> TO		N° SET	L/R	COMPOUND		N° SET	L/R	COMPOUND
...APRILIA											
TUAREG 600 WIND PARIS-DAKAR	600	34	1989 → 1989	FDB529			P		FDB828		ST/P
MOTO 650 6.5	650		1995 → 1999	FDB2006			ST/P/EF		FDB828		ST/P
PEGASO 650	650		1991 → 1995	FDB782			P		FDB828		ST/P
PEGASO 650	650		1996 → 2000	FDB2006			ST/P/EF		FDB828		ST/P
PEGASO 650 / I.E.	650		2001 → 2004	FDB2006			ST/P/EF		FDB2005		ST/SG/P/EF
PEGASO 650 STRADA	650		2004 →	FDB2042			ZRAC/XRAC/ST/P/EF/CPRO		FDB2005		ST/SG/P/EF
PEGASO 650 TRAIL	650		2007 →	FDB2006			ST/P/EF		FDB2005		ST/SG/P/EF
PEGASO 650 Factory	650		2008 →	FDB2245			ST		FDB2005		ST/SG/P/EF
RS 660	660		2020 →	FDB2265	2		ST/EF/CPRO		FDB2074		ST/SM/P/EF/CPRO/AG
Tuono 660	660		2020 →	FDB2265	2		ST/EF/CPRO		FDB2074		ST/SM/P/EF/CPRO/AG
SL 750 SHIVER ABS / GT	750		2008 →	FDB2216	2		ST/SM/CP1		FDB2005		ST/SG/P/EF
SMV 750 Dorsoduro (NO ABS/ABS)	750		2008 →	FDB2216	2		ST/SM/CP1		FDB2005		ST/SG/P/EF
SMV 750 Dorsoduro FACTORY	750		2010 →	FDB2042	2		ZRAC/XRAC/ST/P/EF/CPRO		FDB2005		ST/SG/P/EF
NA 850 MANA ABS / GT	850		2008 →	FDB2216	2		ST/SM/CP1		FDB2060		P/AG
SRV 850 ABS ATC	850		2013 →	FDB2018	2		ZR/ST/SG/P/EF		FDB2142		ST/SM/EF/AG
Dorsoduro	900		2017 →	FDB2216	2		ST/SM/CP1		FDB2005		ST/SG/P/EF
Shiver	900		2017 →	FDB2216	2		ST/SM/CP1		FDB2005		ST/SG/P/EF
ETV 1000 CAPONORD / RALLY RAID	1000		2001 → 2007	FDB2006	2		ST/P/EF		FDB2074		ST/SM/P/EF/CPRO/AG
RST FUTURA 1000	1000		2001 →	FDB2042			ZRAC/XRAC/ST/P/EF/CPRO		FDB2018		ZR/ST/SG/P/EF
RSV 1000 MILLE	1000		1997 → 2000	FDB2042	2		ZRAC/XRAC/ST/P/EF/CPRO		FDB2074		ST/SM/P/EF/CPRO/AG
RSV 1000 MILLE	1000		2001 →	FDB2120	2		ZRAC/XRAC/ST		FDB2074		ST/SM/P/EF/CPRO/AG
RSV 1000 MILLE TUONO RACING	1000		2004 →	FDB2120	2		ZRAC/XRAC/ST		FDB2074		ST/SM/P/EF/CPRO/AG
RSV 1000 TUONO	1000		2004 →	FDB2042	2		ZRAC/XRAC/ST/P/EF/CPRO		FDB2074		ST/SM/P/EF/CPRO/AG
RSV 1000 MILLE R / SP	1000		2000 → 2000	FDB2042	2		ZRAC/XRAC/ST/P/EF/CPRO		FDB2074		ST/SM/P/EF/CPRO/AG
RSV 1000 MILLE R	1000		2001 → 2003	FDB2120	2		ZRAC/XRAC/ST		FDB2074		ST/SM/P/EF/CPRO/AG
RSV 1000 MILLE R FACTORY	1000		2004 →	FDB2120	2		ZRAC/XRAC/ST		FDB2074		ST/SM/P/EF/CPRO/AG
RSV4 Factory /APRC SE /R	1000		2008 →	FDB2260	2		XRAC/ST/CPRO		FDB2074		ST/SM/P/EF/CPRO/AG
RSV4 Factory APRC ABS	1000		2013 →	FDB2260	2		XRAC/ST/CPRO		FDB2074		ST/SM/P/EF/CPRO/AG
RSV4 R APRC ABS	1000		2013 →	FDB2260	2		XRAC/ST/CPRO		FDB2074		ST/SM/P/EF/CPRO/AG
RSV4 RR	1000		2015 →	FDB2260	2		XRAC/ST/CPRO		FDB2074		ST/SM/P/EF/CPRO/AG
RSV4 RF	1000		2016 →	FDB2260	2		XRAC/ST/CPRO		FDB2074		ST/SM/P/EF/CPRO/AG
SL 1000 FALCO	1000		2000 →	FDB2042	2		ZRAC/XRAC/ST/P/EF/CPRO		FDB2074		ST/SM/P/EF/CPRO/AG
TUONO V4 R	1000		2011 → 2012	FDB2042	2		ZRAC/XRAC/ST/P/EF/CPRO		FDB2074		ST/SM/P/EF/CPRO/AG
TUONO V4 R APRC	1000		2011 → 2013	FDB2042	2		ZRAC/XRAC/ST/P/EF/CPRO		FDB2074		ST/SM/P/EF/CPRO/AG
TUONO V4 R APRC ABS	1000		2013 →	FDB2265	2		ST/EF/CPRO		FDB2074		ST/SM/P/EF/CPRO/AG
TUONO V4 Factory	1078		2015 →	FDB2265	2		ST/EF/CPRO		FDB2074		ST/SM/P/EF/CPRO/AG
TUONO V4 RR	1078		2015 →	FDB2265	2		ST/EF/CPRO		FDB2074		ST/SM/P/EF/CPRO/AG
TUONO V4 RR/Factory	1100		2017 →	FDB2260	2		XRAC/ST/CPRO		FDB2074		ST/SM/P/EF/CPRO/AG
CAPONORD 1200	1200		2013 →	FDB2265	2		ST/EF/CPRO		FDB2005		ST/SG/P/EF
CAPONORD 1200 Rally	1200		2015 →	FDB2265	2		ST/EF/CPRO		FDB2005		ST/SG/P/EF
DORSODURO 1200 / ABS / ATC	1200		2011 →	FDB2042	2		ZRAC/XRAC/ST/P/EF/CPRO		FDB2005		ST/SG/P/EF
ASPES											
CS 75 NAVAHO	50		1967 → 1982	FSB898					FSB901		
CS 50 NAVAHO	50		1970 → 1981	FSB907					FSB907		
CM1 80	80		1967 → 1982	FSB898					FSB898		
DUMA 125	125		→	FDB205			P		FSB901		
HOPI 125	125		1972 → 1982	FSB898					FSB901		
JUMA 125	125		1975 → 1979	FSB898					FSB901		
ATALA											
BYTE 50	50		1996 →	FDB680			ST/EF		FSB792		
CAROSSELLO 50	50		1997 →	FDB680			ST/EF		FSB704		
HACKER 50	50		→ 1995	FDB680			ST/EF		FSB792		
HACKER 50	50		1996 →	FDB680			ST/EF		FSB777		
SCHEGGIA 50	50		1998 →	FDB680			ST/EF		FSB777		
ATK (USA)											
all models 1984-85			1984 → 1985	FDB207			ST/P/EF/CP1		FDB213		P
all models 1986			1986 →	FDB207			ST/P/EF/CP1		FDB213		P
all models 1987			1987 →	FDB207			ST/P/EF/CP1		FRP405		ST/SG/PRP/P/EF
all models 1988			1988 →	FDB498			XRAC/ST/P		FDB213		P
all models 1989-93			1989 → 1993	FDB498			XRAC/ST/P		FDB697		EF
all models 1994-95			1994 → 1995	FDB497			ST/SM/SG/P/EF		FDB497		ST/SM/SG/P/EF
all models 1996-01			1996 → 2001	FDB2018			ZR/ST/SG/P/EF		FDB2005		ST/SG/P/EF
500 Dirt Track	500		1998 → 1999	FRP408			XRAC/ST/PRP/CPRO/CP1		FDB2005		ST/SG/P/EF
560	560		1984 → 1985	FDB207			ST/P/EF/CP1				
560	560		1986 → 1987	FDB207			ST/P/EF/CP1		FDB213		P
600 Dirt Track	600		1998 → 1999	FRP408			XRAC/ST/PRP/CPRO/CP1		FDB2005		ST/SG/P/EF

ATK (USA)

* It is recommended that in those applications where sintered pads are supplied as Original Equipment, replacement pads should also be of sintered composition.

** To avoid brake imbalance sintered pads fitted in rear calipers should only be used in combination with front calipers containing sintered pads.



CC KW FROM -> TO N° SET L/R COMPOUND N° SET L/R COMPOUND

BAJAJ

Discover 100 ES (4G)	94	6	2010	→	FSB721				FSB721			
Discover 100	94	6	2011	→	FSB721				FSB721			
CT 100	99	6	2011	→	FSB971				FSB971			
Kawasaki 4S	100		1991	→ 1997	FSB971				FSB971			
Discover 100 M	102	7	2013	→	FSB721				FSB721			
Discover 100 T	102	7	2013	→	FSB721				FSB721			
Platina 100 ES	102	6	2011	→	FSB971				FSB971			
Caliber	110		1998	→ 2003	FSB971				FSB971			
Discover 112	111	7	2004	→	FSB721				FSB721			
Discover 125 ST	124	10	2012	→	FDB2018			ZR/ST/SG/P/EF	FSB721			
Discover 125 T	124	10	2013	→	FDB2018			ZR/ST/SG/P/EF	FSB721			
Discover 125 M	124	9	2014	→	FDB2018			ZR/ST/SG/P/EF	FSB721			
Platina 125 DTS-Si	124	7	2010	→	FSB971				FSB971			
Platina 125 Dumdaar Sawari	124	7	2011	→	FSB971				FSB971			
Discover 125	125		2005	→	FDB2018			ZR/ST/SG/P/EF	FSB721			
Discover 125	125	8	2016	→	FDB2018			ZR/ST/SG/P/EF	FSB721			
Platina	125		2006	→	FSB971				FSB971			
XCD 125 DTS-Si	125	7	2008	→	FSB721				FSB721			
Discover 135	134	10	2008	→	FDB2018			ZR/ST/SG/P/EF	FSB721			
Discover 135 DTS-i	134	9	2010	→	FDB2018			ZR/ST/SG/P/EF	FSB721			
Pulsar 135 DTSi	134	10	2010	→	FDB2018			ZR/ST/SG/P/EF	FSB721			
Pulsar 135 LS	134	10	2011	→	FDB2018			ZR/ST/SG/P/EF	FSB721			
Discover 135	135		2004	→	FDB2018			ZR/ST/SG/P/EF	FSB721			
Pulsar 150 Classic	143	9	2001	→	FDB2018			ZR/ST/SG/P/EF	FSB721			
Discover 150	144	10	2010	→	FDB2018			ZR/ST/SG/P/EF	FSB721			
Discover 150 F	144	15	2016	→	FDB2018			ZR/ST/SG/P/EF	FSB721			
Discover 150 S	144	15	2016	→	FDB2018			ZR/ST/SG/P/EF	FSB721			
Pulsar 150 DTSi UG1	149	10	2003	→	FDB2018			ZR/ST/SG/P/EF	FSB721			
Pulsar 150 DTSi UG2	149	10	2005	→	FDB2018			ZR/ST/SG/P/EF	FSB721			
Pulsar 150 DTSi UG3	149	10	2006	→	FDB2018			ZR/ST/SG/P/EF	FSB721			
Pulsar 150 DTSi UG4	149	11	2006	→	FDB2018			ZR/ST/SG/P/EF	FSB721			
Pulsar 150	149	11	2011	→	FDB2018			ZR/ST/SG/P/EF	FSB721			
Pulsar 150	150		2001	→	FDB2018			ZR/ST/SG/P/EF	FSB721			
Pulsar 150 AS	150	12	2011	→	FDB2018			ZR/ST/SG/P/EF	FSB721			
Eliminator	174	11	2001	→	FDB2018			ZR/ST/SG/P/EF	FSB721			
Pulsar 180 Classic	178	11	2001	→	FDB2018			ZR/ST/SG/P/EF	FSB721			
Pulsar 180 DTSi UG1	178	12	2003	→	FDB2018			ZR/ST/SG/P/EF	FSB721			
Pulsar 180 DTSi UG2	178	12	2005	→	FDB2018			ZR/ST/SG/P/EF	FSB721			
Pulsar 180 DTSi UG3	178	12	2006	→	FDB2018			ZR/ST/SG/P/EF	FSB721			
Pulsar 180 DTSi UG4	178	12	2009	→	FDB2018			ZR/ST/SG/P/EF	FSB721			
Pulsar 180	178	12	2011	→	FDB2018			ZR/ST/SG/P/EF	FSB721			
Avenger 180	180		2005	→ 2007	FDB2018			ZR/ST/SG/P/EF	FSB721			
Eliminator 180	180		2001	→	FDB2018			ZR/ST/SG/P/EF	FSB721			
Pulsar 180	180		2001	→	FDB2018			ZR/ST/SG/P/EF	FSB721			
Pulsar 200 DTSi	198	13	2006	→	FDB2018			ZR/ST/SG/P/EF				
Pulsar 200 DTSi	198	13	2007	→	FDB2018			ZR/ST/SG/P/EF	FSB721			
Pulsar 200 AS	199	18	2011	→	FDB2018			ZR/ST/SG/P/EF	FSB721			
Pulsar 200 NS	199	18	2011	→	FDB2018			ZR/ST/SG/P/EF	FDB2005			ST/SG/P/EF
Pulsar 200 RS	199	18	2011	→					FDB2005			ST/SG/P/EF
Pulsar 200 NS	200		2009	→	FDB2018			ZR/ST/SG/P/EF	FDB2005			ST/SG/P/EF
Pulsar 220 DTS Fi	220	15	2006	→	FDB2018			ZR/ST/SG/P/EF	FDB2285			EF
Pulsar 220	220		2007	→ 2009	FDB2018			ZR/ST/SG/P/EF	FDB2285			EF
Pulsar 220 S DTSi	220	15	2010	→	FDB2018			ZR/ST/SG/P/EF	FDB2285			EF
Pulsar 220 DTS Fi	220	15	2011	→	FDB2018			ZR/ST/SG/P/EF				
Pulsar 220 F	220	15	2011	→	FDB2018			ZR/ST/SG/P/EF	FDB2285			EF

BENELLI

491 50 GT	50		1997	→	FDB680			ST/EF	FSB704			
BOBO 50	50		1978	→	FSB902				FSB902			
CITY BIKE 50	50			→	FSB877				FSB877			
DEVIL 50	50		1992	→	FDB498			XRAC/ST/P	FDB436			P
EXPORT 3 V 50	50		1979	→	FSB902				FSB902			
G 2 50	50		1979	→	FSB902				FSB902			
G 2 50 ELLE	50		1979	→	FSB908				FSB908			
K2 50 all models	50		1998	→ 2001	FDB680			ST/EF	FSB704			
MASTER 4 50	50		1995	→	FDB436			P				
MOTORELLA 50	50		1979	→	FSB902				FSB902			
NAKED 50	50		1998	→	FDB680			ST/EF				
PEPE 50/50 LX/Classic (7 Spoke Cast Wheel)	50		1999	→ 2013	FDB680			ST/EF	FSB704			
Pepe 50 (5 Spoke Cast Wheel/2T/4T)	50		2010	→ 2012	FDB680			ST/EF	FSB704			
QuattroNove X (50cc/All Rear Drum Models)	50		2008	→ 2012	FDB2191			EF	FSB731			
QuattroNove X (50cc/All Rear Disc Models)	50		2010	→ 2012	FDB2191			EF	FDB2191			EF

* It is recommended that in those applications where sintered pads are supplied as Original Equipment, replacement pads should also be of sintered composition.

** To avoid brake imbalance sintered pads fitted in rear calipers should only be used in combination with front calipers containing sintered pads.

1006



	CC	KW	FROM -> TO		N° SET	L/R	COMPOUND		N° SET	L/R	COMPOUND
...BENELLI											
S 50	50		1981 → 1987	FSB877					FSB837		
S 50 LUSO	50		1981 → 1987	FSB877					FSB837		
S 50 (tutti i modelli)	50		1987 →	FSB877					FSB837		
SCOOTY 50	50		→	FSB877					FSB877		
491 50 SPORT - RACING	50	1997	→	FDB680			ST/EF		FDB680		ST/EF
SPRING 50	50	1992	→	FDB498			XRAC/ST/P		FDB436		P
DEVIL 80	80	1995	→	FDB498			XRAC/ST/P		FDB436		P
K2 100 BIPOSTO	100	1999	→	FDB680			ST/EF		FSB947		
125	125	1976	→	FDB207			ST/P/EF/CP1		FSB818		
125 2C Dual brakes	125		→ 1976	FDB207			ST/P/EF/CP1		FSB818		
125 2C	125	1976	→ 1978	FDB207			ST/P/EF/CP1		FSB818		
125 2T - 2 CSE	125	1976	→ 1978	FDB207			ST/P/EF/CP1		FSB818		
666 125	125	1998	→	FDB2042			ZRAC/XRAC/ST/P/EF/CPRO		FDB680		ST/EF
ADIVA 125	125	1999	→	FDB680			ST/EF		FDB2115		P/EF
Caffe Nero 125	125	2011	→	FDB497			ST/SM/SG/P/EF		FDB497		ST/SM/SG/P/EF
Hobby 125 (4T)	125	2013	→ 2013	FDB497			ST/SM/SG/P/EF		FDB497		ST/SM/SG/P/EF
125 JARNO	125	1989	→	FDB498			XRAC/ST/P		FDB2081		AG
Macis 125	125	2010	→	FDB497			ST/SM/SG/P/EF		FDB497		ST/SM/SG/P/EF
S 125 SCOOTER	125		→	FSB856					FSB856		
VELVET 125	125	1999	→ 2008	FDB680			ST/EF		FDB680		ST/EF
Velvet 125 (13" Front Wheel/Touring)	125	2008	→ 2012	FDB677			P/EF		FDB2090		P/EF
X 125	125	2012	→ 2014	FDB497			ST/SM/SG/P/EF		FDB497		ST/SM/SG/P/EF
ADIVA 150	150	1999	→	FDB680			ST/EF		FDB2115		P/EF
Caffe Nero 150	150	2011	→ 2012	FDB497			ST/SM/SG/P/EF		FDB497		ST/SM/SG/P/EF
Macis 150	150	2010	→ 2012	FDB497			ST/SM/SG/P/EF		FDB497		ST/SM/SG/P/EF
VELVET 150	150	1999	→ 2008	FDB680			ST/EF		FDB680		ST/EF
Velvet 150 (13" Front Wheel/Touring)	150	2008	→ 2012	FDB677			P/EF		FDB2090		P/EF
250 4	250	1976	→	FDB207			ST/P/EF/CP1		FSB818		
BN 251	250	2015	→						FDB2090		P/EF
BX Motard (250cc)	250	2012	→	FDB2018			ZR/ST/SG/P/EF		FDB207		ST/P/EF/CP1
250 C	250	1976	→ 1978	FDB207			ST/P/EF/CP1		FSB818		
Caffe Nero 250	250	2008	→ 2011	FDB631		left	ST/SM/SG/P/EF/AG				
Caffe Nero 250	250	2008	→ 2011	FDB497		right	ST/SM/SG/P/EF				
Caffe Nero 250	250	2008	→ 2011						FDB2148		SG/EF
250 TS	250	1976	→ 1978	FDB207			ST/P/EF/CP1		FSB818		
VELVET 250	250	1999	→	FDB677			P/EF		FDB2090		P/EF
254	254	1979	→	FDB213			P		FSB818		
BN 302	300	2015	→						FDB2212		ST/SM/EF
TORNADO 302	300	2016	→						FDB2212		ST/SM/EF
350	350	1983	→	FDB207	2		ST/P/EF/CP1		FDB207		ST/P/EF/CP1
350 4 CIL.	350	1978	→	FDB207			ST/P/EF/CP1		FSB818		
350 SPORT	350	1978	→	FDB207			ST/P/EF/CP1		FDB108		ST/P/EF/CPRO
350 SPORT II	350	1978	→	FDB207			ST/P/EF/CP1		FDB108		ST/P/EF/CPRO
350 T	350	1978	→	FDB207			ST/P/EF/CP1		FDB108		ST/P/EF/CPRO
Zenzero 350	350	2012	→	FDB2305			EF				
BX Cross (449cc)	449	2007	→ 2012	FDB2018			ZR/ST/SG/P/EF		FDB2005		ST/SG/P/EF
BX 449 Motard	449	2010	→	FDB2120			ZRAC/XRAC/ST		FDB2005		ST/SG/P/EF
500	500	1978	→	FDB207			ST/P/EF/CP1		FDB108		ST/P/EF/CPRO
LEONCINO 500	500	2016	→	FDB2042	2		ZRAC/XRAC/ST/P/EF/CPRO		FDB2074		ST/SM/P/EF/CPRO/AG
500 LS	500	1978	→	FDB207			ST/P/EF/CP1		FDB108		ST/P/EF/CPRO
500 QUATTRO	500	1976	→	FDB207			ST/P/EF/CP1		FSB818		
TRK 502	500	2016	→	FDB2042	2		ZRAC/XRAC/ST/P/EF/CPRO		FDB2074		ST/SM/P/EF/CPRO/AG
BX Enduro (505cc)	505	2008	→ 2012	FDB2018			ZR/ST/SG/P/EF		FDB2005		ST/SG/P/EF
BX 570 Motard	570	2008	→ 2010	FDB2120			ZRAC/XRAC/ST		FDB2005		ST/SG/P/EF
BN 600i	600	2014	→	FDB2265	2		ST/EF/CPRO		FDB2074		ST/SM/P/EF/CPRO/AG
BN 600R	600	2014	→	FDB2265	2		ST/EF/CPRO		FDB2074		ST/SM/P/EF/CPRO/AG
BN 600GT	600	2015	→	FDB2265	2		ST/EF/CPRO		FDB2074		ST/SM/P/EF/CPRO/AG
650	650	1982	→	FDB207			ST/P/EF/CP1		FDB108		ST/P/EF/CPRO
650 SPORT	650	1978	→	FDB207			ST/P/EF/CP1		FDB108		ST/P/EF/CPRO
650 T	650	1978	→	FDB207			ST/P/EF/CP1		FDB108		ST/P/EF/CPRO
2 UE 750	750	2009	→ 2010	FDB2042	2		ZRAC/XRAC/ST/P/EF/CPRO		FDB2074		ST/SM/P/EF/CPRO/AG
750 SEI	750	1976	→	FDB108	2		ST/P/EF/CPRO				
TNT 899	899	2007	→	FDB2042	2		ZRAC/XRAC/ST/P/EF/CPRO		FDB2074		ST/SM/P/EF/CPRO/AG
TNT 899 S	899	2007	→ 2011	FDB2042	2		ZRAC/XRAC/ST/P/EF/CPRO		FDB2074		ST/SM/P/EF/CPRO/AG
TNT Cafe Racer 899	899	2010	→ 2012	FDB2120	2		ZRAC/XRAC/ST		FDB2074		ST/SM/P/EF/CPRO/AG
TNT Century Racer 899	899	2011	→ 2012	FDB2120	2		ZRAC/XRAC/ST		FDB2074		ST/SM/P/EF/CPRO/AG
TRE-K 899	899	2007	→ 2014	FDB2042			ZRAC/XRAC/ST/P/EF/CPRO		FDB2074		ST/SM/P/EF/CPRO/AG
900 SEI	900	1978	→	FDB108	2		ST/P/EF/CPRO		FDB204		P
900 TORNADO	900	2000	→	FDB2042	2		ZRAC/XRAC/ST/P/EF/CPRO		FDB2074		ST/SM/P/EF/CPRO/AG
TORNADO TRE 900	900	2002	→	FDB2120	2		ZRAC/XRAC/ST		FDB2074		ST/SM/P/EF/CPRO/AG
TORNADO TRE 900 RS	900	2003	→	FDB2120	2		ZRAC/XRAC/ST		FDB2074		ST/SM/P/EF/CPRO/AG
TNT 1130 Sport/Sport Evo	1130	2004	→ 2009	FDB2120	2		ZRAC/XRAC/ST		FDB2074		ST/SM/P/EF/CPRO/AG
TNT 1130 Cafe Racer	1130	2005	→ 2005	FDB2042	2		ZRAC/XRAC/ST/P/EF/CPRO		FDB2074		ST/SM/P/EF/CPRO/AG
TNT 1130 Titanium	1130	2005	→ 2005	FDB2042	2		ZRAC/XRAC/ST/P/EF/CPRO		FDB2074		ST/SM/P/EF/CPRO/AG

* It is recommended that in those applications where sintered pads are supplied as Original Equipment, replacement pads should also be of sintered composition.

** To avoid brake imbalance sintered pads fitted in rear calipers should only be used in combination with front calipers containing sintered pads.



CC KW FROM -> TO N° SET L/R COMPOUND N° SET L/R COMPOUND

...BENELLI

TNT 1130	1130	2006 → 2010	FDB2120	2		ZRAC/XRAC/ST	FDB2074			ST/SM/P/EF/CPRO/AG
TNT 1130 Cafe Racer	1130	2006 → 2012	FDB2120	2		ZRAC/XRAC/ST	FDB2074			ST/SM/P/EF/CPRO/AG
TNT 1130 Titanium	1130	2006 → 2006	FDB2120	2		ZRAC/XRAC/ST	FDB2074			ST/SM/P/EF/CPRO/AG
TORNADO TRE 1130	1130	2006 →	FDB2120	2		ZRAC/XRAC/ST	FDB2074			ST/SM/P/EF/CPRO/AG
TNT R 160	1130	2009 → 2012	FDB2120	2		ZRAC/XRAC/ST	FDB2074			ST/SM/P/EF/CPRO/AG
TNT 1130 Century Racer	1130	2011 →	FDB2120	2		ZRAC/XRAC/ST	FDB2074			ST/SM/P/EF/CPRO/AG
TNT 1130 R	1130	2011 → 2013	FDB2120	2		ZRAC/XRAC/ST	FDB2074			ST/SM/P/EF/CPRO/AG
TNT 1130 R	1130	2014 →	FDB2260	2		XRAC/ST/CPRO	FDB2074			ST/SM/P/EF/CPRO/AG
TRE-K 1130	1130	2006 →	FDB2042	2		ZRAC/XRAC/ST/P/EF/CPRO	FDB2074			ST/SM/P/EF/CPRO/AG
TRE-K 1130 Amazonas	1130	2007 →	FDB2042	2		ZRAC/XRAC/ST/P/EF/CPRO	FDB2074			ST/SM/P/EF/CPRO/AG

BETA

ALP 50	50	1991 →	FDB436			P	FDB697			EF
ANDY 50 alloy wheels	50	1978 →	FSB902				FSB902			
ANDY 50 spoke wheels	50	1978 →	FSB902				FSB902			
ARK 50 all models	50	1996 →	FDB680			ST/EF	FDB680			ST/EF
B12 50	50	1973 →	FSB902				FSB902			
CH 50	50	1996 →	FDB680			ST/EF	FSB704			
CHRONO 50	50	1992 → 1994	FDB697			EF	FSB704			
CHRONO 50	50	1994 →	FDB697			EF	FSB704			
CHRONO 50 13	50	1994 →	FDB680			ST/EF	FSB704			
CHRONO 50 502	50	1997 →	FDB680			ST/EF	FSB704			
EIKON 50	50	1999 →	FRP405			ST/SG/PRP/P/EF	FRP405			ST/SG/PRP/P/EF
FOUR 50 AE	50	1987 →	FDB436			P	FSB907			
FOUR 50 S	50	1987 →	FDB436			P	FSB907			
FOUR TWIN 50	50	1988 →	FDB436			P	FSB907			
KR 50	50	1987 →	FDB697			EF	FDB624			AG
KR 50 ADVENTURE	50	1987 →	FDB697			EF	FDB624			AG
M4 50	50	1983 →					FSB907			
M6 50	50	1983 →					FSB907			
MINICROSS 50 PRO RACE 12/10	50	2004 → 2006	FDB2127			SG	FDB2127			SG
Minitrial 50	50	2009 → 2012	FDB2127			SG				
MIO 50	50	1979 →	FSB902				FSB902			
MS 50	50	1980 →	FDB213			P	FSB907			
MX 50 ENDURO	50	1992 →	FDB2107			P	FDB2107			P
MX4 50 Special	50	1970 →	FSB907				FSB907			
MX6 50 EXPORT	50	1977 →	FSB897				FSB897			
MX6 50	50	1982 →	FSB898				FSB898			
Pro Race 50	50	2005 →	FRP405			ST/SG/PRP/P/EF	FDB2127			SG
PULMAN 50	50	1970 →	FSB910				FSB910			
QUADRA 50	50	1995 →	FDB680			ST/EF	FSB704			
R 150 (Minicross /4T/49cc)	50	2010 → 2012	FDB312			ST/P/EF	FDB694			ST/AG
REV 50	50	2000 →	FRP405			ST/SG/PRP/P/EF	FRP405			ST/SG/PRP/P/EF
RR 50 PRO RACE	50	1998 →	FDB706			P	FRP405			ST/SG/PRP/P/EF
RR 50 all models	50	1999 →	FDB706			P	FRP405			ST/SG/PRP/P/EF
RR 50 Enduro	50	2004 → 2007	FDB677			P/EF	FDB2206			P
RR 50 Standard	50	2005 → 2008	FDB677			P/EF	FRP405			ST/SG/PRP/P/EF
RR 50 Enduro	50	2008 → 2012	FDB677			P/EF	FDB2162			SG/P/EF
RR Motard 50 Track (Cast Wheels)	50	2008 → 2012	FDB677			P/EF	FDB2162			SG/P/EF
RR 50 Enduro Racing	50	2009 → 2011	FDB677			P/EF	FDB2162			SG/P/EF
RR 50 Enduro Standard	50	2009 → 2012	FRP405			ST/SG/PRP/P/EF	FDB2162			SG/P/EF
RR 50 Motard (Spoke Wheel)	50	2009 → 2012	FDB677			P/EF	FDB2206			P
RR 50 Motard Standard	50	2009 → 2012	FRP405			ST/SG/PRP/P/EF	FDB2162			SG/P/EF
RR 50 Motard Skull	50	2011 →	FDB677			P/EF	FDB2162			SG/P/EF
RR 50 Enduro Factory	50	2012 →	FDB677			P/EF	FDB2162			SG/P/EF
RX 50	50	1984 →					FSB768			
SCRAMBLER 50 4 M	50	1982 →	FSB907				FSB907			
SQUIRREL 50	50	1983 →	FDB213			P	FSB907			
SUPERMOTARD 50	50	2000 →	FRP405			ST/SG/PRP/P/EF	FRP405			ST/SG/PRP/P/EF
SUPERTRIAL 50	50	1992 →	FRP405			ST/SG/PRP/P/EF	FRP405			ST/SG/PRP/P/EF
TECHNO 50	50	1996 →	FRP405			ST/SG/PRP/P/EF	FRP405			ST/SG/PRP/P/EF
TEMPO 50	50	1993 →	FDB697			EF	FSB704			
TR 50	50	1980 → 1986	FSB907				FSB897			
TR 50	50	1987 → 1988	FSB898				FSB898			
TR 50 (SPAIN)	50	1989 →	FRP405			ST/SG/PRP/P/EF	FSB898			
EVO 80	80	2009 → 2012	FDB2109			P				
EVO 80 Junior	80	2009 → 2012	FRP405			ST/SG/PRP/P/EF	FRP405			ST/SG/PRP/P/EF
REV 80	80	2000 → 2007	FRP405			ST/SG/PRP/P/EF	FRP405			ST/SG/PRP/P/EF
REV 80	80	2008 → 2011	FDB2109			P				
TR 80	80	1980 →	FSB907				FSB897			
125 6V	125	1974 →	FSB901				FSB901			
ALP 125 4T	125	1999 → 2003	FRP405			ST/SG/PRP/P/EF	FRP405			ST/SG/PRP/P/EF

* It is recommended that in those applications where sintered pads are supplied as Original Equipment, replacement pads should also be of sintered composition.

** To avoid brake imbalance sintered pads fitted in rear calipers should only be used in combination with front calipers containing sintered pads.

1008



CC KW FROM -> TO N° SET L/R COMPOUND N° SET L/R COMPOUND

...BETA

ALP 125 4T	125	2005	→ 2012	FDB677			P/EF	FDB2206		P
CR 125	125		→ 1981	FSB897				FSB901		
CR 125	125	1982	→	FSB901				FSB901		
CUSTOM 125	125	1982	→	FDB205			P	FSB876		
EIKON 125	125	1999	→	FDB2081			AG	FDB2090		P/EF
EVO 125 2T	125	2009	→	FDB2109			P	FDB2267		SG
JONATHAN 125	125	1999	→ 2001	FRP408			XRAC/ST/PRP/P/CPRO/CP1	FDB2005		ST/SG/P/EF
JONATHAN 125	125	2002	→ 2005	FRP408			XRAC/ST/PRP/P/CPRO/CP1	FDB2005		ST/SG/P/EF
KR 125	125	1986	→	FDB207			ST/P/EF/CP1			
KR 125 AFRIKA	125	1987	→	FDB207			ST/P/EF/CP1			
R 125 4T (Pit Bike)	125	2008	→	FDB636			P/EF	FRP405		ST/SG/PRP/P/EF
RC 125	125	1976	→	FSB897				FSB901		
RC 125 EXPORT ASPIRATO	125	1980	→	FSB901				FSB901		
RC 125 (liquid cooled)	125	1981	→	FSB901				FSB901		
RE 125 4T Enduro	125	2009	→ 2010	FDB677			P/EF	FDB2162		SG/P/EF
RE 125 4T Enduro	125	2010	→ 2012	FRP405			ST/SG/PRP/P/EF	FDB2162		SG/P/EF
Rev 3 125	125	2000	→ 2005	FDB2109			P	FDB2109		P
Rev 3 125	125	2006	→ 2008	FDB2109			P			
RR 125 4T Motard (A/C - Spoke Wheel)	125	2008	→ 2012	FDB677			P/EF	FDB2162		SG/P/EF
RR 125 4T Enduro (A/C)	125	2009	→ 2011	FDB677			P/EF	FDB2162		SG/P/EF
RR 125 4T Enduro (L/C)	125	2011	→	FDB677			P/EF	FDB2162		SG/P/EF
RR 125 4T Motard (L/C - Cast Wheel)	125	2011	→ 2012	FDB677			P/EF	FDB2162		SG/P/EF
RR Enduro 125 2T	125	2018	→	FDB892			ZR/SG/P/EF/CPRO	FDB2162		SG/P/EF
RX 125	125	1983	→					FSB898		
RX 125	125	1984	→					FSB768		
125 SCRAMBLER	125	1982	→	FSB901				FSB876		
TR 125	125	1980	→ 1985	FSB898				FSB898		
TR 32 125	125	1986	→	FDB436			P	FSB898		
TR 33 125	125	1987	→	FDB436			P	FSB898		
TR 34 125	125	1988	→	FDB436			P	FDB697		EF
TR 35 125	125	1990	→	FRP405			ST/SG/PRP/P/EF	FRP405		ST/SG/PRP/P/EF
TRIAL 125	125	1997	→	FRP405			ST/SG/PRP/P/EF			
Urban 125	125	2008	→ 2012	FDB677			P/EF	FDB2206		P
Urban 125 Special	125	2009	→ 2012	FDB677			P/EF	FDB2162		SG/P/EF
EIKON 150	150	1999	→	FDB2081			AG	FDB2090		P/EF
ALP 200 4T	200	2000	→ 2003	FRP405			ST/SG/PRP/P/EF	FRP405		ST/SG/PRP/P/EF
ALP 200 4T	200	2005	→ 2012	FDB677			P/EF	FDB2206		P
EVO 200 2T	200	2009	→ 2012	FDB2109			P	FDB2267		SG
Rev 3 200	200	2006	→ 2008	FDB2109			P			
URBAN 200	200	2008	→ 2012	FDB677			P/EF	FDB2206		P
Urban 200 Special	200	2009	→ 2012	FDB677			P/EF	FDB2162		SG/P/EF
ALP 240	240	1991	→ 1995	FDB436			P			
ALP 240	240	1996	→	FRP405			ST/SG/PRP/P/EF	FDB207		ST/P/EF/CP1
SUPERTRIAL 240	240	1992	→	FRP405			ST/SG/PRP/P/EF			
TR 240	240	1980	→ 1983	FSB898				FSB898		
TR 32 240	240	1984	→ 1985	FSB898				FSB898		
TR 32 240 (mozzo ant autocentrante)	240	1984	→ 1985					FSB898		
TR 33 240	240	1986	→ 1988	FDB436			P	FSB898		
TR 33 TREKKING 240	240	1988	→	FDB436			P	FSB905		
TREKKING 240	240	1987	→	FSB898				FSB898		
ALP 250	250	1997	→	FRP405			ST/SG/PRP/P/EF	FRP405		ST/SG/PRP/P/EF
CR 250	250	1983	→	FDB207			ST/P/EF/CP1	FSB901		
CR - RV 250	250	1981	→	FSB901				FSB852		
CUSTOM 250	250	1982	→	FDB205			P	FSB876		
Evo 250 (2T)	250	2009	→ 2012	FDB2109			P	FDB2267		SG
Evo 250 (4T)	250	2009	→ 2012	FDB2109			P	FDB2267		SG
GS - RV 250	250		→ 1980	FSB901				FSB901		
KR 250 AFRIKA	250	1986	→	FDB207			ST/P/EF/CP1			
KR 250 RALLY	250	1987	→	FDB207			ST/P/EF/CP1			
REV 3 250	250	2000	→ 2004	FDB2109			P	FDB2109		P
REV 3 250	250	2005	→ 2008	FDB2109			P			
REV 3 250 4T	250	2007	→ 2008	FDB2109			P			
REV 3 250 2T	250	2008	→	FDB2109			P			
RR 250 4T Enduro	250	2005	→ 2007	FDB892			ZR/SG/P/EF/CPRO	FDB2162		SG/P/EF
RR 250 2T Enduro	250	2015	→	FDB892			ZR/SG/P/EF/CPRO	FDB2162		SG/P/EF
TECHNO 250	250	1996	→	FRP405			ST/SG/PRP/P/EF	FRP405		ST/SG/PRP/P/EF
TR 34 250	250	1986	→ 1988	FDB436			P	FDB697		EF
TR 34 250 (SPAIN)	250	1989	→	FDB436			P	FDB436		P
TR 34 250 PROFESSIONAL	250	1989	→	FDB436			P	FDB697		EF
TR 35 250	250	1990	→ 1991	FRP405			ST/SG/PRP/P/EF	FRP405		ST/SG/PRP/P/EF
ALP 260	260	1990	→	FDB436			P			
SYNT 260	260	1992	→	FDB2107			P			
TR 34 260	260	1987	→ 1988	FDB436			P	FDB697		EF
TR 35 260	260	1989	→ 1991	FDB436			P			

* It is recommended that in those applications where sintered pads are supplied as Original Equipment, replacement pads should also be of sintered composition.

** To avoid brake imbalance sintered pads fitted in rear calipers should only be used in combination with front calipers containing sintered pads.



CC KW FROM -> TO



N° SET L/R COMPOUND



N° SET L/R COMPOUND

...BETA

ZERO 260 SYNT	260	1989 → 1992	FDB2107			P			
ZERO 260 GARA - TECHNO - SYNT	260	1993 →	FDB2107			P			
Rev 3 270	270	2000 → 2004	FDB2109			P	FDB2109		P
Rev 3 270	270	2005 → 2008	FDB2109			P			
EVO 290 2T	290	2009 →	FDB2109			P	FDB2267		SG
EVO 300 2T/4T	300	2009 → 2012	FDB2109			P	FDB2267		SG
RR 300 2T Enduro	300	2015 →	FDB892			ZR/SG/P/EF/CPRO	FDB2162		SG/P/EF
XTRAINER 300	300	2015 →	FDB892			ZR/SG/P/EF/CPRO	FDB2162		SG/P/EF
ALP 4.0 350	350	2004 →	FDB677			P/EF	FDB694		ST/AG
ALP 4.0 350 4T	350	2005 → 2012	FDB677			P/EF	FDB2206		P
CR - RV 350	350	1980 →	FSB901				FSB852		
EURO 350	350	1999 → 2001	FRP408			XRAC/ST/PRP/PI/CPRO/CP1	FDB2005		ST/SG/P/EF
EURO 350	350	2002 →	FRP408			XRAC/ST/PRP/PI/CPRO/CP1	FDB2005		ST/SG/P/EF
EURO / JONATHAN 350	350	2003 → 2006	FRP408			XRAC/ST/PRP/PI/CPRO/CP1	FDB383		SG/P/EF
GS - RV 350	350	1980 →	FSB901				FSB852		
M4 Supermotard	350	2004 → 2006	FDB2185			P	FDB694		ST/AG
M4 Supermotard	350	2006 → 2012	FDB2185			P	FDB2206		P
RR 350 4T Enduro	350	2011 →	FDB892			ZR/SG/P/EF/CPRO	FDB2162		SG/P/EF
RR 350 EFI 4T Enduro	350	2015 →	FDB892			ZR/SG/P/EF/CPRO	FDB2162		SG/P/EF
RR 390 4T Enduro	390	2015 →	FDB892			ZR/SG/P/EF/CPRO	FDB2162		SG/P/EF
RR 400 4T Enduro	400	2005 →	FDB892			ZR/SG/P/EF/CPRO	FDB2162		SG/P/EF
RR 430 4T Enduro	430	2015 →	FDB892			ZR/SG/P/EF/CPRO	FDB2162		SG/P/EF
RR 450 4T Enduro	450	2005 → 2013	FDB892			ZR/SG/P/EF/CPRO	FDB2162		SG/P/EF
RR 450 4T Cross Country	450	2012 →	FDB892			ZR/SG/P/EF/CPRO	FDB2162		SG/P/EF
RR 480 4T Enduro	480	2015 →	FDB892			ZR/SG/P/EF/CPRO	FDB2162		SG/P/EF
GS - RV 500	500	1984 →	FDB207			ST/P/EF/CP1	FSB852		
RR 498 4T Enduro	500	2012 →	FDB892			ZR/SG/P/EF/CPRO	FDB2162		SG/P/EF
RR 520 4T Enduro	520	2010 → 2011	FDB892			ZR/SG/P/EF/CPRO	FDB2162		SG/P/EF
RR 525 4T Enduro	525	2005 → 2009	FDB892			ZR/SG/P/EF/CPRO	FDB2162		SG/P/EF

BIMOTA

YB 7 400	400	1989 →	FRP408	2		XRAC/ST/PRP/PI/CPRO/CP1	FDB207		ST/P/EF/CP1
V DUE 500	500	1997 →	FRP408	2		XRAC/ST/PRP/PI/CPRO/CP1	FDB207		ST/P/EF/CP1
BELLARIA 600 SPORT	600	1991 →	FRP408	2		XRAC/ST/PRP/PI/CPRO/CP1	FDB108		ST/P/EF/CPRO
YB 9 600 SRI	600	1997 →	FRP408	2		XRAC/ST/PRP/PI/CPRO/CP1	FDB207		ST/P/EF/CP1
SUPERMONO 650	650	1997 →	FRP408	2		XRAC/ST/PRP/PI/CPRO/CP1	FDB207		ST/P/EF/CP1
SB 7 750	750	1996 →	FRP408	2		XRAC/ST/PRP/PI/CPRO/CP1	FDB207		ST/P/EF/CP1
YB 4 750	750	1989 →	FRP408	2		XRAC/ST/PRP/PI/CPRO/CP1	FDB207		ST/P/EF/CP1
Tesi 3D Race Cafe'	800	2016 →	FDB2260	2		XRAC/ST/CPRO	FDB2074		ST/SM/P/EF/CPRO/AG
TESI 851 1D	851	1991 →	FRP408	2		XRAC/ST/PRP/PI/CPRO/CP1	FDB108		ST/P/EF/CPRO
DB 1 - 2 900	900	1992 →	FRP408	2		XRAC/ST/PRP/PI/CPRO/CP1	FDB207		ST/P/EF/CP1
MANTRA 900	900	1997 →	FRP408	2		XRAC/ST/PRP/PI/CPRO/CP1	FDB207		ST/P/EF/CP1
DB 2 SR 904	904	1994 → 2000	FRP408	2		XRAC/ST/PRP/PI/CPRO/CP1	FDB207		ST/P/EF/CP1
DB 4 904	904	1998 → 1999	FRP408	2		XRAC/ST/PRP/PI/CPRO/CP1	FDB207		ST/P/EF/CP1
TESI 906 1D	906	1991 →	FRP408	2		XRAC/ST/PRP/PI/CPRO/CP1	FDB108		ST/P/EF/CPRO
DB6 Delirio (992cc) Ducati engine	992	2007 →	FDB2120	2		ZRAC/XRAC/ST	FDB2074		ST/SM/P/EF/CPRO/AG
SB8K Gobert (Suzuki Engine) (996cc)	996	2006 →	FDB2042	2		ZRAC/XRAC/ST/P/EF/CPRO	FDB207		ST/P/EF/CP1
1000 all models ->1988	1000	→ 1998	FDB108	2		ST/P/EF/CPRO	FDB108		ST/P/EF/CPRO
BB3	1000	2014 →	FDB2260			XRAC/ST/CPRO	FDB2074		ST/SM/P/EF/CPRO/AG
DB5 (All models)	1000	2006 → 2007	FDB2120	2		ZRAC/XRAC/ST	FDB2074		ST/SM/P/EF/CPRO/AG
SB 3 1000	1000	1983 →	FDB108	2		ST/P/EF/CPRO	FDB108		ST/P/EF/CPRO
SB 8 1000 R	1000	1998 →	FDB2042	2		ZRAC/XRAC/ST/P/EF/CPRO	FDB207		ST/P/EF/CP1
YB 10 1000 BIPOSTO	1000	1992 →	FRP408	2		XRAC/ST/PRP/PI/CPRO/CP1	FDB207		ST/P/EF/CP1
YB 11 1000	1000	1997 →	FRP408	2		XRAC/ST/PRP/PI/CPRO/CP1	FDB207		ST/P/EF/CP1
YB 6 1000	1000	1989 →	FRP408	2		XRAC/ST/PRP/PI/CPRO/CP1	FDB207		ST/P/EF/CP1
YB 8 1000 E	1000	1990 →	FRP408	2		XRAC/ST/PRP/PI/CPRO/CP1	FDB207		ST/P/EF/CP1
YB 8 1000 E.I. FURANO	1000	1990 →	FRP408	2		XRAC/ST/PRP/PI/CPRO/CP1	FDB207		ST/P/EF/CP1
YB 8 FURANO 1000	1000	1992 →	FRP408	2		XRAC/ST/PRP/PI/CPRO/CP1	FDB207		ST/P/EF/CP1
YB 10 DIECI 1002	1002	1991 →	FRP408	2		XRAC/ST/PRP/PI/CPRO/CP1	FDB108		ST/P/EF/CPRO
DB5R	1078	2006 → 2007	FDB2120	2		ZRAC/XRAC/ST	FDB2074		ST/SM/P/EF/CPRO/AG
DB5R/S (1078cc)	1078	2008 → 2009	FDB2120	2		ZRAC/XRAC/ST	FDB207		ST/P/EF/CP1
DB6 Delirio	1078	2006 →	FDB2120	2		ZRAC/XRAC/ST	FDB2074		ST/SM/P/EF/CPRO/AG
DB6 (1078cc)	1078	2008 → 2009	FDB2120	2		ZRAC/XRAC/ST	FDB207		ST/P/EF/CP1
DB6/R (1078cc)	1078	2008 → 2009	FDB2120	2		ZRAC/XRAC/ST	FDB207		ST/P/EF/CP1
DBX	1078	2013 →	FDB2006			ST/P/EF	FDB2018		ZR/ST/SG/P/EF
Tesi 3D Naked	1078	2007 →	FDB2120	2		ZRAC/XRAC/ST	FDB2074		ST/SM/P/EF/CPRO/AG
Tesi 3D (1078cc)	1078	2009 →	FDB2120	2		ZRAC/XRAC/ST	FDB207		ST/P/EF/CP1
DB7 (1098cc)	1098	2008 →	FDB2120	2		ZRAC/XRAC/ST	FDB2074		ST/SM/P/EF/CPRO/AG
DB7 Oronero Millenovantotto	1098	2009 →	FDB2260	2		XRAC/ST/CPRO	FDB2074		ST/SM/P/EF/CPRO/AG
DB7 (1099cc)	1099	2009 →	FDB2260	2		XRAC/ST/CPRO	FDB207		ST/P/EF/CP1
DB6 (1100cc)	1100	2008 →	FDB2120	2		ZRAC/XRAC/ST	FDB2074		ST/SM/P/EF/CPRO/AG
DB6R Delirio (1100cc)	1100	2008 →	FDB2120	2		ZRAC/XRAC/ST	FDB2074		ST/SM/P/EF/CPRO/AG

* It is recommended that in those applications where sintered pads are supplied as Original Equipment, replacement pads should also be of sintered composition.

** To avoid brake imbalance sintered pads fitted in rear calipers should only be used in combination with front calipers containing sintered pads.

1010



CC KW FROM -> TO



N° SET L/R COMPOUND



N° SET L/R COMPOUND

...BIMOTA

SB 6 1100	1100	1997 →	FRP408	2		XRAC/ST/PRP/PI/CPRO/CP1	FDB207			ST/P/EF/CP1
DB8 (1198cc)	1198	2010 →	FDB2260	2		XRAC/ST/CPRO	FDB2074			ST/SM/P/EF/CPRO/AG
DB8 Oronero	1198	2010 →	FDB2260			XRAC/ST/CPRO	FDB2074			ST/SM/P/EF/CPRO/AG
DB9 Brivido	1198	2012 →	FDB2120			ZRAC/XRAC/ST	FDB2074			ST/SM/P/EF/CPRO/AG
Impeto	1198	2016 →	FDB2260	2		XRAC/ST/CPRO	FDB2074			ST/SM/P/EF/CPRO/AG

BMW

C evolution (elettrico)		2014 →	FDB570	2		XRAC/ST/SM/P/EF/CPRO	FDB570			XRAC/ST/SM/P/EF/CPRO
C1 125 Scooter	125	2000 → 2003	FDB2006			ST/P/EF	FDB2005			ST/SG/P/EF
C1 200 Scooter	200	2001 → 2003	FDB2006			ST/P/EF	FDB2005			ST/SG/P/EF
G 310 GS	313	2017 →	FDB2266			ST/EF	FDB2005			ST/SG/P/EF
G 310 R	313	2016 →	FDB2266			ST/EF	FDB2005			ST/SG/P/EF
C400	400	2018 →	FDB2266	2		ST/EF	FDB2005			ST/SG/P/EF
C 400 GT	400	25 2019 →	FDB2266	2		ST/EF	FDB2005			ST/SG/P/EF
G450 X	450	2008 →	FDB2018			ZR/ST/SG/P/EF	FDB2165			SG/P/EF
R 45 450	450	1978 → 1981	FDB108	2		ST/P/EF/CPRO	FSB700			
R 45 450	450	1981 → 1985	FDB108	2		ST/P/EF/CPRO	FSB701			
R 50/5 500	500	1969 → 1975	FSB806				FSB700			
C 600 GT Special Edition	600	2015 →	FDB570	2		XRAC/ST/SM/P/EF/CPRO	FDB570			XRAC/ST/SM/P/EF/CPRO
C 600 SPORT	600	2012 →	FDB570	2		XRAC/ST/SM/P/EF/CPRO	FDB570			XRAC/ST/SM/P/EF/CPRO
C 600 SPORT Highline	600	2013 →	FDB570	2		XRAC/ST/SM/P/EF/CPRO	FDB570			XRAC/ST/SM/P/EF/CPRO
C 600 SPORT Special Edition	600	2015 →	FDB570	2		XRAC/ST/SM/P/EF/CPRO	FDB570			XRAC/ST/SM/P/EF/CPRO
R 60/5 600	600	→ 1975	FSB806				FSB700			
R 60/6 600	600	→ 1975	FSB806				FSB700			
R 60/7 600	600	1976 → 1978	FDB155			P	FSB700			
C 650 Evo	650	2020 →	FDB570	2		XRAC/ST/SM/P/EF/CPRO	FDB570			XRAC/ST/SM/P/EF/CPRO
C 650 GT	650	2012 →	FDB570	2		XRAC/ST/SM/P/EF/CPRO	FDB570			XRAC/ST/SM/P/EF/CPRO
C 650 GT Highline	650	2013 →	FDB570	2		XRAC/ST/SM/P/EF/CPRO	FDB570			XRAC/ST/SM/P/EF/CPRO
C 650 SPORT	650	35 2015 →	FDB570	2		XRAC/ST/SM/P/EF/CPRO	FDB570			XRAC/ST/SM/P/EF/CPRO
C 650 SPORT	650	44 2015 →	FDB570	2		XRAC/ST/SM/P/EF/CPRO	FDB570			XRAC/ST/SM/P/EF/CPRO
F 650 / 650 ST	650	1994 → 2000	FDB2006			ST/P/EF	FDB2005			ST/SG/P/EF
F 650 CS	650	2001 →	FDB2006			ST/P/EF	FDB2005			ST/SG/P/EF
F 650 SCARVER	650	2002 →	FDB2006			ST/P/EF	FDB2005			ST/SG/P/EF
F 650 GS	650	2001 → 2008	FDB2006			ST/P/EF	FDB2005			ST/SG/P/EF
G650 GS	650	2011 →	FDB2006			ST/P/EF	FDB2005			ST/SG/P/EF
G 650 X Challenge / X Country	650	2007 →	FDB2006			ST/P/EF	FDB2005			ST/SG/P/EF
G 650 X Moto	650	2008 →	FDB2042			ZRAC/XRAC/ST/P/EF/CPRO	FDB2005			ST/SG/P/EF
R 65 650	650	→ 1980	FDB108			ST/P/EF/CPRO	FSB700			
R 65 650 LS	650	→ 1981	FDB108			ST/P/EF/CPRO	FSB804			
R 65 650	650	1981 → 1989	FDB108	2		ST/P/EF/CPRO	FDB108			ST/P/EF/CPRO
R 65 650 LS	650	1981 → 1985	FDB108	2		ST/P/EF/CPRO	FSB701			
R 65 650 GS	650	1987 → 1988	FDB108			ST/P/EF/CPRO	FSB701			
R 65 650	650	1989 → 2000	FDB108	2		ST/P/EF/CPRO	FSB701			
R 65 650 GS	650	1989 → 1992	FDB204	2		P	FSB701			
F700 GS	700	25 2013 →	FDB2006	2		ST/P/EF	FDB2005			ST/SG/P/EF
F700 GS	700	35 2013 →	FDB2006	2		ST/P/EF	FDB2005			ST/SG/P/EF
F700 GS	700	52 2013 →	FDB2006	2		ST/P/EF	FDB2005			ST/SG/P/EF
F700 GS	700	55 2013 →	FDB2006	2		ST/P/EF	FDB2005			ST/SG/P/EF
F750 GS	750	2018 →	FDB2006	2		ST/P/EF	FDB2005			ST/SG/P/EF
K 75 750	750	1984 → 1988	FDB108	2		ST/P/EF/CPRO	FSB805			
K 75 750 S	750	1985 → 1988	FDB108	2		ST/P/EF/CPRO	FDB108			ST/P/EF/CPRO
K 75 750 S	750	1988 → 1993	FDB108	2		ST/P/EF/CPRO	FDB108			ST/P/EF/CPRO
K 75 750	750	1990 → 1996	FDB736	2		ST/P	FDB108			ST/P/EF/CPRO
K 75 750 (ABS caliper)	750	1991 → 1996	FDB736	2		ST/P	FDB108			ST/P/EF/CPRO
K 75 750 RT	750	1991 → 1993	FDB736	2		ST/P	FDB108			ST/P/EF/CPRO
K 75 750 RT	750	1994 → 2000	FDB736	2		ST/P	FDB108			ST/P/EF/CPRO
K 75 750 S	750	1994 → 2000	FDB204	2		P	FDB204			P
R 75/5 750	750	→ 1975	FSB806				FSB700			
R 75/6 750	750	1975 → 1979	FDB155	2		P	FSB700			
F800 GT	800	2013 →	FDB2042	2		ZRAC/XRAC/ST/P/EF/CPRO	FDB2005			ST/SG/P/EF
F800 R	800	2015 →	FDB2265	2		ST/EF/CPRO	FDB2005			ST/SG/P/EF
F 650 GS (K72)	800	2008 → 2012	FDB2006			ST/P/EF	FDB2005			ST/SG/P/EF
F800 S / ST / R	800	2007 →	FDB2042	2		ZRAC/XRAC/ST/P/EF/CPRO	FDB2005			ST/SG/P/EF
F800 GS	800	35 2008 →	FDB2006	2		ST/P/EF	FDB2005			ST/SG/P/EF
F800 GS	800	61 2008 →	FDB2006	2		ST/P/EF	FDB2005			ST/SG/P/EF
F800 GS	800	63 2008 →	FDB2006	2		ST/P/EF	FDB2005			ST/SG/P/EF
F800 GS Triple Black	800	63 2011 →	FDB2006	2		ST/P/EF	FDB2005			ST/SG/P/EF
F800 GS Trophy	800	63 2011 →	FDB2006	2		ST/P/EF	FDB2005			ST/SG/P/EF
F800 GS Adventure	800	2012 →	FDB2006	2		ST/P/EF	FDB2005			ST/SG/P/EF
R 80 800 all models	800	1977 → 1981	FDB155			P	FSB700			
R 80 800 GS / PARIS-DAKAR	800	1981 → 1986	FDB108			ST/P/EF/CPRO	FSB701			
R 80 800 all models	800	1982 → 1984	FDB108	2		ST/P/EF/CPRO	FSB701			

* It is recommended that in those applications where sintered pads are supplied as Original Equipment, replacement pads should also be of sintered composition.

** To avoid brake imbalance sintered pads fitted in rear calipers should only be used in combination with front calipers containing sintered pads.



CC KW FROM -> TO N° SET L/R COMPOUND N° SET L/R COMPOUND

...BMW

R 80 800 all models	800	1985	→ 1989	FDB108	2		ST/P/EF/CPRO	FSB701		
R 80 800 GS / PARIS-DAKAR	800	1987	→ 1995	FDB204			P	FSB701		
R 80 800 all models	800	1989	→ 1995	FDB736	2		ST/P	FSB701		
R 80 RT	800	1990	→ 1994	FDB204	2		P	FSB701		
R 80 800 R ROADSTER	800	1993	→ 1994	FDB2050			ST/P	FDB736		ST/P
F 850 GS Rallye	850	70	2019 →	FDB2006	2		ST/P/EF	FDB2005		ST/SG/P/EF
F850 GS	850		2018 →	FDB2006	2		ST/P/EF	FDB2005		ST/SG/P/EF
F 850 GS Adventure	850		2020 →	FDB2006	2		ST/P/EF	FDB2005		ST/SG/P/EF
R 850 R ROADSTER	850		1995 → 2000	FDB108			ST/P/EF/CPRO	FDB2039		ST/P/EF
R 850 RT	850		1998 → 2001	FDB2050	2		ST/P	FDB2005		ST/SG/P/EF
R 850 C	850		1999 → 2000	FDB2050	2		ST/P	FDB2039		ST/P/EF
R 850 GS	850		1999 → 2000	FDB2050	2		ST/P	FDB2039		ST/P/EF
R 850 R	850		2001 →	FDB2124	2		ST/P	FDB2039		ST/P/EF
R 850 RT	850		2002 → 2003	FDB2125	2		ST/P	FDB2039		ST/P/EF
F 900 R	895	77	2020 →	FDB2265	2		ST/EF/CPRO	FDB2005		ST/SG/P/EF
F 900 XR	895	77	2020 →	FDB2265	2		ST/EF/CPRO	FDB2005		ST/SG/P/EF
R 90 900 S	900		1973 → 1976	FDB155	2		P	FSB700		
R 90/6 900	900		1973 → 1976	FDB155			P	FSB700		
HP4 1000 (K42)	1000		2013 →	FDB2260	2		XRAC/ST/CPRO	FDB2005		ST/SG/P/EF
HP4 Race	1000		2019 →	FDB2260	2		XRAC/ST/CPRO			
K 1 1000	1000		1989 → 1993	FDB2050	2		ST/P	FDB108		ST/P/EF/CPRO
K 100 1000	1000		→ 1988	FDB108	2		ST/P/EF/CPRO	FDB108		ST/P/EF/CPRO
K 100 1000 LT	1000		1987 → 1988	FDB108	2		ST/P/EF/CPRO	FDB108		ST/P/EF/CPRO
K 100 1000 LT	1000		1988 → 1992	FDB736	2		ST/P	FDB108		ST/P/EF/CPRO
K 100 1000 RS	1000		1983 → 1988	FDB108	2		ST/P/EF/CPRO	FDB108		ST/P/EF/CPRO
K 100 1000 RS	1000		1988 → 1989	FDB736	2		ST/P	FDB108		ST/P/EF/CPRO
K 100 1000 RS 16 VALVES	1000		1990 → 1992	FDB2050	2		ST/P	FDB108		ST/P/EF/CPRO
K 100 1000 RT	1000		1983 → 1988	FDB108	2		ST/P/EF/CPRO	FDB108		ST/P/EF/CPRO
K 100 1000 RT	1000		1988 → 1989	FDB108	2		ST/P/EF/CPRO	FDB108		ST/P/EF/CPRO
R 100 1000 all models	1000		→ 1981	FDB155	2		P	FSB700		
R 100 1000 all models	1000		1981 → 1989	FDB108	2		ST/P/EF/CPRO	FSB701		
R 100 1000 RS - RT - CS	1000		1981 → 1988	FDB108	2		ST/P/EF/CPRO	FDB108		ST/P/EF/CPRO
R 100 1000 GS / PARIS-DAKAR	1000		1987 → 1994	FDB204			P	FSB701		
R 100 1000 R	1000		1991 → 1995	FDB2050	2		ST/P	FSB863		
R 100 1000 RT	1000		1991 → 1995	FDB108	2		ST/P/EF/CPRO	FSB863		
R 100 1000 R ROADSTER - MYSTIC	1000		1993 → 1996	FDB736	2		ST/P	FSB863		
S 1000 XR	1000	121	2020 →	FDB2321	2		XRAC/ST	FDB2039		ST/P/EF
S1000 R Naked (K47)	1000		2014 →	FDB2255	2		XRAC/ST	FDB2005		ST/SG/P/EF
S1000 RR (K46)	1000		2010 → 2014	FDB2255	2		XRAC/ST	FDB2005		ST/SG/P/EF
S1000 RR	1000	152	2015 → 2018	FDB2255	2		XRAC/ST	FDB2005		ST/SG/P/EF
S1000 RR	1000	152	2019 →	FDB2321	2		XRAC/ST	FDB2005		ST/SG/P/EF
S1000 XR (K49)	1000	118	2015 →	FDB2265	2		ST/EF/CPRO	FDB2039		ST/P/EF
K 1100 LT (ABS)	1100		1992 → 1997	FDB2050	2		ST/P	FDB736		ST/P
K 1100 RS (ABS and NOT)	1100		1994 → 1999	FDB2050	2		ST/P	FDB736		ST/P
K 1100 RT (ABS)	1100		1994 → 1999	FDB2050	2		ST/P	FDB736		ST/P
R 1100 GS (ABS)	1100		1994 → 1999	FDB2050	2		ST/P	FDB2039		ST/P/EF
R 1100 RS (ABS)	1100		1994 → 2001	FDB2050	2		ST/P	FDB108		ST/P/EF/CPRO
R 1100 R ROADSTER	1100		1995 → 2000	FDB2050	2		ST/P	FDB2039		ST/P/EF
R 1100 RT (ABS)	1100		1995 → 2001	FDB2050	2		ST/P	FDB2039		ST/P/EF
R 1100 S (no ABS)	1100		2001 →	FDB2125	2		ST/P	FDB2039		ST/P/EF
R 1100 S ABS	1100		2001 →	FDB2124	2		ST/P	FDB2039		ST/P/EF
R 1150 GS	1150		1998 → 2001	FDB2050	2		ST/P	FDB2039		ST/P/EF
R 1150 GS	1150		2001 →	FDB2050	2		ST/P	FDB2039		ST/P/EF
R 1150 R	1150		2001 →	FDB2124	2		ST/P	FDB2039		ST/P/EF
R 1150 R ROADSTER	1150		2001 →	FDB2124	2		ST/P	FDB2039		ST/P/EF
R 1150 RT	1150		2001 →	FDB2125	2		ST/P	FDB2039		ST/P/EF
R 1150 RS	1150		2002 →	FDB2125	2		ST/P	FDB2039		ST/P/EF
R 1150 GS ADVENTURE	1150		2003 →	FDB2125	2		ST/P	FDB2039		ST/P/EF
R nineT (R1ST)	1170	79	2014 →	FDB2265	2		ST/EF/CPRO	FDB2018		ZR/ST/SG/P/EF
R nineT (R1ST)	1170	81	2014 →	FDB2265	2		ST/EF/CPRO	FDB2018		ZR/ST/SG/P/EF
R nineT Scrambler	1170		2016 →	FDB2042	2		ZRAC/XRAC/ST/P/EF/CPRO	FDB2018		ZR/ST/SG/P/EF
R nineT Pure	1170		2017 →	FDB2042	2		ZRAC/XRAC/ST/P/EF/CPRO	FDB2018		ZR/ST/SG/P/EF
R nineT Racer	1170		2017 →	FDB2042	2		ZRAC/XRAC/ST/P/EF/CPRO	FDB2018		ZR/ST/SG/P/EF
R NineT Urban G/S	1170		2017 →	FDB2042	2		ZRAC/XRAC/ST/P/EF/CPRO	FDB2018		ZR/ST/SG/P/EF
HP2 Enduro 1200	1200		2004 → 2006	FDB2006			ST/P/EF	FDB2039		ST/P/EF
HP2 Megamoto 1200	1200		2008 →	FDB2125	2		ST/P	FDB2039		ST/P/EF
HP2 Sport 1200	1200		2008 →	FDB2260	2		XRAC/ST/CPRO	FDB2039		ST/P/EF
K 1200 R	1200		2004 →	FDB2125	2		ST/P	FDB2039		ST/P/EF
K 1200 S	1200		2004 →	FDB2125	2		ST/P	FDB2039		ST/P/EF
K 1200 GT	1200		2003 → 2007	FDB2125	2		ST/P	FDB108		ST/P/EF/CPRO
K 1200 GT	1200		2007 →	FDB2125	2		ST/P	FDB2039		ST/P/EF
K 1200 LT (K589)	1200	72	1999 → 2001	FDB2050	2		ST/P	FDB2102		ST/P
K 1200 LT (K589)	1200	72	2001 → 2003	FDB2124	2		ST/P	FDB2102		ST/P
K 1200 LT (K589)	1200	85	2003 → 2008	FDB2124	2		ST/P	FDB2102		ST/P

* It is recommended that in those applications where sintered pads are supplied as Original Equipment, replacement pads should also be of sintered composition.

** To avoid brake imbalance sintered pads fitted in rear calipers should only be used in combination with front calipers containing sintered pads.



	CC	KW	FROM -> TO	N° SET	L/R	COMPOUND	N° SET	L/R	COMPOUND
...BMW									
K 1200 RS	1200		1997 → 2001	FDB2050	2	ST/P	FDB108		ST/P/EF/CPRO
K 1200 RS	1200		2002 →	FDB2125	2	ST/P	FDB108		ST/P/EF/CPRO
K 1200 RT	1200		2008 →	FDB2124	2	ST/P	FDB2039		ST/P/EF
K 1200 ST	1200		1999 → 2001	FDB2050	2	ST/P	FDB736		ST/P
R 1200 C (259C)	1200		1997 → 2000	FDB2050	2	ST/P	FDB2039		ST/P/EF
R 1200 C CLASSIC	1200		2003 →	FDB2124	2	ST/P	FDB2039		ST/P/EF
R 1200 CL	1200		2003 →	FDB2124	2	ST/P	FDB2102		ST/P
R 1200 C MONTAUK	1200		2004 →	FDB2124	2	ST/P	FDB2039		ST/P/EF
R 1200 ST	1200		2005 → 2007	FDB2125	2	ST/P	FDB2039		ST/P/EF
R 1200 RT (K26)	1200	79	2006 → 2013	FDB2125	2	ST/P	FDB2039		ST/P/EF
R 1200 S	1200		2006 → 2008	FDB2125	2	ST/P	FDB2039		ST/P/EF
R 1200 R (R1ST)	1200	72	2006 →	FDB2124	2	ST/P	FDB2039		ST/P/EF
R 1200 R (R1ST)	1200	79	2006 →	FDB2124	2	ST/P	FDB2039		ST/P/EF
R 1200 R (R1ST)	1200	80	2006 →	FDB2124	2	ST/P	FDB2039		ST/P/EF
R 1200 RT (K52)	1200		2014 →	FDB2265	2	ST/EF/CPRO	FDB2006		ST/P/EF
R 1200 R (K53)	1200		2015 →	FDB2265	2	ST/EF/CPRO	FDB2006		ST/P/EF
R 1200 RS	1200		2015 →	FDB2265	2	ST/EF/CPRO	FDB2006		ST/P/EF
R 1200 GS (R12)	1200	72	2004 → 2012	FDB2125	2	ST/P	FDB2039		ST/P/EF
R 1200 GS (R12)	1200	74	2004 → 2012	FDB2125	2	ST/P	FDB2039		ST/P/EF
R 1200 GS Adventure (R12)	1200	74	2004 → 2012	FDB2125	2	ST/P	FDB2039		ST/P/EF
R 1200 GS Adventure (K25)	1200	72	2006 → 2012	FDB2125	2	ST/P	FDB2039		ST/P/EF
R 1200 GS Adventure Triple Black (K25)	1200	81	2006 → 2012	FDB2125	2	ST/P	FDB2039		ST/P/EF
R 1200 GS Adventure (K25)	1200	77	2007 → 2009	FDB2125	2	ST/P	FDB2039		ST/P/EF
R 1200 GS (K25)	1200	77	2008 → 2009	FDB2125	2	ST/P	FDB2039		ST/P/EF
R 1200 GS (K25)	1200	81	2009 → 2012	FDB2125	2	ST/P	FDB2039		ST/P/EF
R 1200 GS Adventure (K25)	1200	81	2009 → 2012	FDB2125	2	ST/P	FDB2039		ST/P/EF
R 1200 GS Adventure (K51)	1200	81	2013 →	FDB2265	2	ST/EF/CPRO	FDB2006		ST/P/EF
R 1200 GS (K50)	1200	79	2013 →	FDB2265	2	ST/EF/CPRO	FDB2006		ST/P/EF
R 1200 GS (K50)	1200	92	2013 →	FDB2265	2	ST/EF/CPRO	FDB2006		ST/P/EF
R 1200 GS Exclusive	1200		2017 →	FDB2265	2	ST/EF/CPRO	FDB2006		ST/P/EF
R 1200 GS Rallye	1200		2017 →	FDB2265	2	ST/EF/CPRO	FDB2006		ST/P/EF
R 1250 GS Adventure	1250	100	2019 →	FDB2321	2	XRAC/ST	FDB2006		ST/P/EF
R 1250 GS	1250	100	2019 →	FDB2321	2	XRAC/ST	FDB2006		ST/P/EF
R 1250 R	1250	100	2019 →	FDB2265	2	ST/EF/CPRO	FDB2006		ST/P/EF
R 1250 RS	1250	100	2019 →	FDB2265	2	ST/EF/CPRO	FDB2006		ST/P/EF
R 1250 RT	1250	100	2019 →	FDB2321	2	XRAC/ST	FDB2006		ST/P/EF
K 1300 GT	1300		2009 →	FDB2125	2	ST/P	FDB2039		ST/P/EF
K 1300 R	1300		2009 →	FDB2124	2	ST/P	FDB2039		ST/P/EF
K 1300 S	1300		2009 →	FDB2125	2	ST/P	FDB2039		ST/P/EF
K 1300 S Motorsport	1300		2015 →	FDB2125	2	ST/P	FDB2039		ST/P/EF
K 1600 GT	1600		2011 →	FDB2124	2	ST/P	FDB2006		ST/P/EF
K 1600 GTL	1600		2011 →	FDB2124	2	ST/P	FDB2006		ST/P/EF
K 1600 B Grand America	1600		2018 →	FDB2124	2	ST/P	FDB2006		ST/P/EF
K 1600 B	1649		2017 →	FDB2124	2	ST/P	FDB2006		ST/P/EF
BRANDY-BRAS									
BRANDY 50	50		→				FSB731		
BRANDY 90	90		→				FSB731		
BS VILLA									
AX 50	50		1993 →	FDB636		P/EF	FSB704		
GZ 50	50		1993 →	FDB636		P/EF	FSB704		
ZX 50	50		1993 →	FDB625		EF	FSB714		
BSA									
A 7 - A 10 125	125		→				FSB924		
BANTAM D1 125	125		→	FSB917			FSB917		
BANTAM D7 175	175		→	FSB916			FSB916		
C15 250	250		→	FSB918			FSB918		
BUELL									
S1 Lightning-Whitelighting			1998 → 2002	FDB2036		XRAC/ST/P	FDB531		ST/P/EF
S3-S3T Thunderbolt			1998 → 2002	FDB2036		XRAC/ST/P	FDB531		ST/P/EF
X1			1998 → 2002	FDB2036		XRAC/ST/P	FDB531		ST/P/EF
X1 Lightning			2000 → 2005	FDB2036		XRAC/ST/P	FDB531		ST/P/EF
Blast 500	500		2000 → 2007	FDB664		ST/P/EF	FDB531		ST/P/EF
Firebolt XB9R	984		2002 → 2007	FDB2145		XRAC/ST	FDB531		ST/P/EF

BUELL

* It is recommended that in those applications where sintered pads are supplied as Original Equipment, replacement pads should also be of sintered composition.

** To avoid brake imbalance sintered pads fitted in rear calipers should only be used in combination with front calipers containing sintered pads.



CC KW FROM -> TO N° SET L/R COMPOUND N° SET L/R COMPOUND

...BUELL

XB9S Lightning	984	2003 → 2004	FDB2145			XRAC/ST	FDB531		ST/P/EF
XB9SX Lightning CityX	984	2005 → 2009	FDB2145			XRAC/ST	FDB531		ST/P/EF
XB9 SX Lightning	984	2008 → 2010	FDB2145			XRAC/ST	FDB531		ST/P/EF
1125R	1125	2008 → 2010	FDB2240			ST			
1125CR	1125	2009 → 2010	FDB2240			ST			
M2 Cyclone, S1 Lightning, S2-S3 Thunderbolt	1200	1994 → 1997	FDB847	2		P	FDB314		ST/SG/P/EF
M2 Cyclone	1200	1998 → 2002	FDB2036			XRAC/ST/P	FDB531		ST/P/EF
M2 Cyclone	1200	2000 → 2005	FDB2036			XRAC/ST/P	FDB531		ST/P/EF
XB12 R Firebolt	1200	2004 → 2008	FDB2145			XRAC/ST	FDB531		ST/P/EF
XB12 R Firebolt	1200	2009 → 2010	FDB2240			ST	FDB531		ST/P/EF
XB12 STT Lightning	1200	→ 2008	FDB2145			XRAC/ST	FDB531		ST/P/EF
XB12 S Lightning	1200	2004 → 2008	FDB2145			XRAC/ST	FDB531		ST/P/EF
XB12 SCG Lightning	1200	2006 → 2008	FDB2145			XRAC/ST	FDB531		ST/P/EF
XB12 Ss Lightning Long	1200	2006 → 2008	FDB2145			XRAC/ST	FDB531		ST/P/EF
XB12 S Lightning	1200	2009 → 2010	FDB2240			ST	FDB531		ST/P/EF
XB12 SCG Lightning	1200	2009 → 2010	FDB2240			ST	FDB531		ST/P/EF
XB12 Ss Lightning Long	1200	2009 → 2010	FDB2240			ST	FDB531		ST/P/EF
XB12 X Ulysses	1200	2006 → 2010	FDB2145			XRAC/ST	FDB531		ST/P/EF
XB12 XT Ulysses	1200	2008 → 2010	FDB2145			XRAC/ST	FDB531		ST/P/EF

BULTACO

LOBITO 50	50	1998 →	FDB706			P	FRP405		ST/SG/PRP/P/EF
LOBITO 75	75	1999 →	FDB706			P	FDB2107		P
LOBITO 125 Mk3	125	1970 → 1972	FSB807				FSB807		
LOBITO 125 Mk6	125	1972 → 1973	FSB807				FSB807		
LOBITO 125 Mk7	125	1973 → 1974	FSB807				FSB807		
LOBITO 125 Mk8	125	1974 → 1976	FSB807				FSB807		
PURSANG MK6 125	125	1972 → 1973	FSB807						
PURSANG MK7/8 125	125	1973 → 1976	FSB807				FSB857		
PURSANG MK9 125	125	1976 →	FSB807				FSB807		
SHERPA 125	125	→	FSB807				FSB857		
TRIAL 125	125	→	FSB807				FSB807		
SHERPA 150	150	→	FSB807				FSB857		
SHERPA 151	151	→	FSB807				FSB857		
PURSANG MK6 175	175	1972 → 1973	FSB807						
PURSANG MK6 200	200	1972 → 1973	FSB807						
PURSANG MK9 200	200	1976 →	FSB807				FSB807		
FRONTERA 250 all models	250	→	FSB857				FSB857		
LOBITO 250	250	→	FSB807				FSB807		
PURSANG MK6 250	250	1972 → 1973	FSB807						
PURSANG MK7/8 250	250	1973 → 1976	FSB807				FSB857		
PURSANG MK9 250	250	1976 →	FSB857				FSB857		
PURSANG MK10 250	250	1977 →	FSB807				FSB857		
PURSANG MK11 250	250	1977 →	FSB807				FSB857		
PURSANG MK12 250	250	1978 →	FSB807				FSB857		
SHERPA 250	250	1999 →	FRP405			ST/SG/PRP/P/EF	FRP405		ST/SG/PRP/P/EF
SHERPA 250 A	250	→	FSB807				FSB807		
SHERPA 250 I	250	→	FSB807				FSB807		
SHERPA 250 N	250	→	FSB807				FSB807		
TRIAL 250	250	→	FSB807				FSB807		
FRONTERA 350 all models	350	→	FSB857				FSB857		
PURSANG MK6 350	350	1972 → 1973	FSB807						
SHERPA 350 A	350	→	FSB807				FSB807		
SHERPA 350 I	350	→	FSB807				FSB807		
SHERPA 350 N	350	→	FSB807				FSB807		
TRIAL 350	350	→	FSB807				FSB807		
PURSANG MK7/8 360	360	1973 → 1976	FSB807				FSB857		
PURSANG MK11 370	370	→					FSB857		
PURSANG MK9 370	370	1976 →	FSB857				FSB857		
PURSANG MK10 370	370	1977 →	FSB857				FSB857		
PURSANG MK11 370	370	1977 → 1979	FSB857						
PURSANG MK12 370	370	1978 →	FSB857				FSB857		

CAGIVA

BLUES 50	50	1989 →	FDB438			P/EF	FDB694		ST/AG
CITY 50	50	1992 → 1994	FDB625			EF	FSB704		
CITY 50	50	1995 →	FDB2190			EF	FSB704		
CORSA 50	50	1998 →	FRP405			ST/SG/PRP/P/EF			
COCIS 50	50	1988 →	FDB207			ST/P/EF/CP1	FDB694		ST/AG
COCIS 50	50	1989 →	FDB207			ST/P/EF/CP1	FDB207		ST/P/EF/CP1

* It is recommended that in those applications where sintered pads are supplied as Original Equipment, replacement pads should also be of sintered composition.

** To avoid brake imbalance sintered pads fitted in rear calipers should only be used in combination with front calipers containing sintered pads.



CC KW FROM -> TO N° SET L/R COMPOUND



N° SET L/R COMPOUND

...CAGIVA

Model	CC	KW	FROM -> TO	N° SET	L/R	COMPOUND	N° SET	L/R	COMPOUND
CUCCILO 50	50		1997 →	FDB207		ST/P/EF/CP1			
LUCKY EXPLORER 50	50		1988 →	FDB207		ST/P/EF/CP1	FDB694		ST/AG
MANTIS 50	50		1998 →	FRP405		ST/SG/PRP/P/EF	FSB777		
MITO 50	50		1998 →	FDB438		P/EF	FRP405		ST/SG/PRP/P/EF
NUVOLA 50	50		2000 →	FDB680		ST/EF			
PASSING 50	50		1995 →	FDB2190		EF			
PROGRESS 50	50		1997 →	FRP405		ST/SG/PRP/P/EF	FSB777		
STELLA 50	50		1997 →	FDB2190		EF	FDB2190		EF
SUPERCITY 50	50		1993 →	FDB529		P	FDB207		ST/P/EF/CP1
W4 PRO ACTION 50	50		1994 →	FDB207		ST/P/EF/CP1	FDB694		ST/AG
WMX 50	50		1989 →	FDB499		P	FDB828		ST/P
COCIS 80	80		1989 →	FDB207		ST/P/EF/CP1	FDB694		ST/AG
SUPERCITY 80	80		1994 →	FDB529		P	FDB207		ST/P/EF/CP1
W4 PRO ACTION 80	80		1994 →	FDB207		ST/P/EF/CP1	FDB694		ST/AG
N 90 ENDURO	90		1990 →	FDB499		P	FDB828		ST/P
ALETTA 125 ELECTRA	125		→ 1984	FDB694		ST/AG	FSB844		
ALETTA 125 ELECTRA	125		1984 →	FDB694		ST/AG	FSB846		
ALETTA 125 ORO S2	125		1986 →	FDB694	2	ST/AG	FDB694		ST/AG
ALETTA 125 ELECTRA CLASSIC	125		1987 →	FDB694		ST/AG	FDB694		ST/AG
ALETTA 125 ELECTRA	125		1988 →	FDB694		ST/AG	FSB901		
BLUES 125	125		1988 → 1992	FDB438		P/EF	FDB207		ST/P/EF/CP1
BLUES 125	125		1993 →	FDB438		P/EF	FDB694		ST/AG
CRUISER 125	125		1987 →	FDB499		P	FDB694		ST/AG
DAKAR 125	125		1985 →	FDB694		ST/AG			
ELEFANT 125	125		→ 1984	FDB694		ST/AG	FSB844		
ELEFANT 125	125		1984 →	FDB694		ST/AG	FSB846		
ELEFANT 125	125		1985 → 1986	FDB694		ST/AG			
ELEFANT 125	125		1987 →	FDB207		ST/P/EF/CP1			
FRECCIA 125	125		1987 →	FDB499		P	FDB207		ST/P/EF/CP1
FRECCIA 125 C10	125		1988 →	FDB529		P	FDB207		ST/P/EF/CP1
FRECCIA 125 C10 R	125		1988 →	FDB529		P	FDB207		ST/P/EF/CP1
FRECCIA 125 C9	125		1988 →	FDB499		P	FDB207		ST/P/EF/CP1
FRECCIA 125 C10 ANNIVERSARIO	125		1989 →	FDB529		P	FDB207		ST/P/EF/CP1
FRECCIA 125 C12 R	125		1989 → 1990	FDB529		P	FDB207		ST/P/EF/CP1
FRECCIA 125 C12 R	125		1991 →	FDB529		P	FDB207		ST/P/EF/CP1
GP 125 S ALETTA ORO	125		1985 →	FDB694	2	ST/AG	FDB694		ST/AG
K7 125 ENDURO	125		1991 →	FDB529		P	FDB207		ST/P/EF/CP1
MITO 125	125		1991 → 1992	FDB529		P	FDB207		ST/P/EF/CP1
MITO 125	125		1993 →	FRP408		XRAC/ST/PRP/P/CPRO/CP1	FDB207		ST/P/EF/CP1
MITO 2 125 PRODUCTION RACER / Trofeo	125		1994 →	FRP408		XRAC/ST/PRP/P/CPRO/CP1	FDB207		ST/P/EF/CP1
MITO 525SP	125		2007 →	FRP408	2	XRAC/ST/PRP/P/CPRO/CP1	FDB207		ST/P/EF/CP1
N 125	125		1991 →	FDB529		P	FDB694		ST/AG
NUVOLA 125	125		2000 →	FDB680		ST/EF			
PASSING 125	125		1993 → 1997	FDB2190		EF	FSB704		
PLANET 125	125		1998 →	FRP408		XRAC/ST/PRP/P/CPRO/CP1	FDB207		ST/P/EF/CP1
RAPTOR 125	125		2003 →	FRP408		XRAC/ST/PRP/P/CPRO/CP1	FDB207		ST/P/EF/CP1
ROADSTER 125	125		1994 →	FDB438		P/EF			
SST 125 spoke wheel	125		→	FDB694		ST/AG			
SST 125	125		1981 →	FDB694		ST/AG	FSB901		
SST 125 LOW RIDER	125		1983 →	FDB694		ST/AG			
SUPERCITY 125	125		1994 →	FDB529		P	FDB207		ST/P/EF/CP1
SXT 125	125		1982 →	FDB694		ST/AG	FSB898		
TAMANACO 125	125		1989 →	FDB529		P	FDB694		ST/AG
W8 125 PRO ACTION	125		1992 → 1995	FDB529		P	FDB207		ST/P/EF/CP1
W8 125 PRO ACTION	125		1996 →	FDB529		P	FDB694		ST/AG
WMX 125	125		→ 1982	FSB898			FSB898		
WMX 125 /3	125		→ 1983	FSB898			FSB898		
WMX 125 (mozzi Rimoldi)	125		1984 →				FSB898		
WMX 125 CROSS	125		1986 →	FDB207		ST/P/EF/CP1	FSB841		
WMX 125 CROSS	125		1987 →	FDB499		P	FSB841		
WRX 125	125		1982 →	FSB898			FSB898		
WRX 125 /1	125		1983 →	FSB898			FSB898		
WR 125	125		1993 →	FDB497		ST/SM/SG/P/EF	FDB250		SG/P/EF
WSXT 125 ALETTA ROSSA	125		1983 →	FDB694		ST/AG	FSB844		
XRX 125	125		1980 →	FSB898			FSB898		
XSST 125	125		→ 1980	FDB694		ST/AG			
XSST 125 ruota integrale	125		1978 →				FSB901		
XSST 125	125		1981 →	FDB694		ST/AG			
XWMX 125	125		1981 →	FSB898			FSB898		
ELEFANT 200	200		1985 →	FDB694		ST/AG			
ELEFANT 200 A.E.	200		1986 →	FDB694		ST/AG			
ELEFANT 200	200		1988 →	FDB694		ST/AG			
ROADSTER 200	200		1996 →	FDB438		P/EF			
ALA BLU 250	250		1983 →	FDB207		ST/P/EF/CP1	FSB849		

CAGIVA

* It is recommended that in those applications where sintered pads are supplied as Original Equipment, replacement pads should also be of sintered composition.

** To avoid brake imbalance sintered pads fitted in rear calipers should only be used in combination with front calipers containing sintered pads.



CC KW FROM -> TO N° SET L/R COMPOUND N° SET L/R COMPOUND

...CAGIVA

ALA ROSSA 250	250	1983 →	FDB207			ST/P/EF/CP1	FSB849		
ALA VERDE 250	250	1983 →	FDB207			ST/P/EF/CP1	FSB853		
MXR 250	250	→ 1981	FSB901				FSB901		
RX 250	250	→ 1981	FSB901				FSB901		
SST 250	250	→ 1978	FSB849						
SST 250	250	1979 → 1980	FSB849						
SST 250	250	1980 →	FDB207			ST/P/EF/CP1	FSB849		
SSX 250	250	1982 →	FDB207			ST/P/EF/CP1	FSB853		
ST 250	250	1982 →	FDB207			ST/P/EF/CP1	FSB853		
SX 250	250	→ 1982	FSB849				FSB849		
SX 250	250	1982 →	FDB207			ST/P/EF/CP1	FSB849		
WMX 250	250	→ 1982	FDB207			ST/P/EF/CP1	FSB898		
WMX 250 /1	250	1983 →	FDB207			ST/P/EF/CP1	FSB898		
WMX 250 CROSS	250	1987 →	FDB499			P	FSB841		
WRX 250	250	→ 1983	FSB898				FSB898		
WRX 250	250	1983 →	FDB207			ST/P/EF/CP1	FSB898		
ALA AZZURRA 350	350	1983 →	FDB207			ST/P/EF/CP1	FSB853		
ALA AZZURRA 350 GT	350	1987 →	FDB207	2		ST/P/EF/CP1	FDB592		P
ALA BLU 350	350	1983 →	FDB207			ST/P/EF/CP1	FSB849		
ALA ROSSA 350	350	1983 →	FDB207			ST/P/EF/CP1	FSB849		
ALA ROSSA 350	350	1988 →	FDB207			ST/P/EF/CP1	FSB849		
ALA VERDE 350	350	1983 →	FDB207			ST/P/EF/CP1	FSB853		
DG 350 TRIAL	350	1983 →	FSB826				FSB826		
ELEFANT 350	350	1985 →	FDB592			P	FDB207		ST/P/EF/CP1
SST 350	350	→ 1978	FSB849				FSB849		
SST 350	350	1981 →	FDB207			ST/P/EF/CP1	FSB849		
SX 350	350	→ 1978	FSB849				FSB849		
SX 350	350	1979 → 1982	FSB849				FSB849		
SX 350	350	1982 →	FDB207			ST/P/EF/CP1	FSB853		
T4 350 R - ER	350	1987 →	FDB207			ST/P/EF/CP1			
W 12 350	350	1992 →	FDB529			P	FDB207		ST/P/EF/CP1
MXR 400	400	→ 1981	FSB901				FSB901		
CANYON 500	500	1995 →	FDB497			ST/SM/SG/P/EF	FDB631		ST/SM/SG/P/EF/AG
MXR 500	500	→ 1981	FSB901				FSB901		
T4 500 E - ER	500	1987 →	FDB207			ST/P/EF/CP1			
WMX 500	500	1984 →	FDB207			ST/P/EF/CP1	FSB845		
CANYON 600	600	1996 → 1997	FDB663			ST/P/EF	FDB631		ST/SM/SG/P/EF/AG
RIVER 600	600	1994 →	FRP408			XRAC/ST/PRP/P/CPRO/CP1	FDB207		ST/P/EF/CP1
ALA AZZURRA 650	650	1984 →	FDB207	2		ST/P/EF/CP1	FDB207		ST/P/EF/CP1
ALA AZZURRA 650 GT	650	1987 →	FDB438	2		P/EF	FDB207		ST/P/EF/CP1
ELEFANT 650	650	1985 →	FDB592			P	FDB207		ST/P/EF/CP1
RAPTOR 650 / 650 i.e.	650	2001 →	FDB2042	2		ZRAC/XRAC/ST/P/EF/CPRO	FDB2074		ST/SM/P/EF/CPRO/AG
V RAPTOR 650	650	2001 →	FDB2042	2		ZRAC/XRAC/ST/P/EF/CPRO	FDB2074		ST/SM/P/EF/CPRO/AG
W 16 650	650	1993 →	FDB529			P	FDB207		ST/P/EF/CP1
DAKAR 750	750	1987 →	FDB592			P	FDB207		ST/P/EF/CP1
ELEFANT 750	750	1987 →	FDB592			P	FDB207		ST/P/EF/CP1
ELEFANT 750	750	1988 → 1989	FDB592			P	FDB529		P
ELEFANT 750 BIFARO	750	1990 →	FDB499			P	FDB706		P
ELEFANT 750	750	1994 →	FDB663			ST/P/EF	FDB2018		ZR/ST/SG/P/EF
CANYON 900 I.E.	900	1997 →	FDB663			ST/P/EF	FDB631		ST/SM/SG/P/EF/AG
900 CAT	900	1993 →	FDB570	2		XRAC/ST/SM/P/EF/CPRO	FDB664		ST/P/EF
ELEFANT 900 I.E. - GT - AC	900	1991 →	FDB663			ST/P/EF	FDB631		ST/SM/SG/P/EF/AG
GRAN CANYON 900	900	1999 →	FDB570	2		XRAC/ST/SM/P/EF/CPRO	FDB631		ST/SM/SG/P/EF/AG
ELEFANT 906	906	1990 →	FDB663			ST/P/EF	FDB631		ST/SM/SG/P/EF/AG
NAVIGATOR / NAVIGATOR T	1000	2000 → 2005	FDB570	2		XRAC/ST/SM/P/EF/CPRO	FDB631		ST/SM/SG/P/EF/AG
NAVIGATOR 1000	1000	2001 →	FDB664	2		ST/P/EF	FDB631		ST/SM/SG/P/EF/AG
RAPTOR 1000	1000	2000 →	FDB2042	2		ZRAC/XRAC/ST/P/EF/CPRO	FDB2074		ST/SM/P/EF/CPRO/AG
RAPTOR V 1000	1000	2001 →	FDB2042	2		ZRAC/XRAC/ST/P/EF/CPRO	FDB2074		ST/SM/P/EF/CPRO/AG
RAPTOR X3 1000	1000	2003 →	FDB2120	2		ZRAC/XRAC/ST	FDB2074		ST/SM/P/EF/CPRO/AG
RAPTOR XTRA 1000	1000	2003 →	FDB2042	2		ZRAC/XRAC/ST/P/EF/CPRO	FDB2074		ST/SM/P/EF/CPRO/AG

CANNONDALE

MX 400	400	2000 → 2002	FDB892			ZR/SG/P/EF/CPRO	FDB659		SG/P/EF
440 (All Enduro / MX Models)	440	2003 →	FDB892			ZR/SG/P/EF/CPRO	FDB659		SG/P/EF
S 440 SUPERMOTO	440	2003 →	FDB892			ZR/SG/P/EF/CPRO	FDB659		SG/P/EF

CASAL

50 CICLOMOTORI (diam.110)	50	→	FSB860				FSB860		
50 CICLOMOTORI (diam.140)	50	→	FSB861				FSB861		
RZ 50	50	→	FDB213			P			

* It is recommended that in those applications where sintered pads are supplied as Original Equipment, replacement pads should also be of sintered composition.

** To avoid brake imbalance sintered pads fitted in rear calipers should only be used in combination with front calipers containing sintered pads.

1016



CC KW FROM -> TO N° SET L/R COMPOUND



N° SET L/R COMPOUND

CCM

604 E 600 SPORT	600	1999	→	FDB2018			ZR/ST/SG/P/EF	FDB2005			ST/SG/P/EF
604 E 600 SUPERMOTO	600	1999	→	FDB2018			ZR/ST/SG/P/EF	FDB2005			ST/SG/P/EF
C 25 600	600	1996	→	FDB2018			ZR/ST/SG/P/EF	FDB2005			ST/SG/P/EF
604 RS ROADSTER	604	2000	→	FDB2018			ZR/ST/SG/P/EF	FDB2005			ST/SG/P/EF

CFMOTO

CF 125 T-21A E-Charm	125	2010	→ 2012	FDB497			ST/SM/SG/P/EF	FDB2074			ST/SM/P/EF/CPRO/AG
CF 125 T-22 Glory	125	2010	→ 2011	FDB497			ST/SM/SG/P/EF	FDB2074			ST/SM/P/EF/CPRO/AG
CF 150 Leader	150	2010	→ 2012	FDB384			P	FSB721			
CF 150 T-5i E-Charm	150	2010	→ 2012	FDB497			ST/SM/SG/P/EF	FDB2074			ST/SM/P/EF/CPRO/AG
CF 150 T-6A Glory	150	2010	→ 2011	FDB497			ST/SM/SG/P/EF	FDB2074			ST/SM/P/EF/CPRO/AG
CF 250 T - 5 Custom	250	2011	→ 2012	FDB781			ST/P/EF	FDB383			SG/P/EF
CF 250 T - 6A (Scooter)	250	2012	→	FDB312	2		ST/P/EF	FDB2074			ST/SM/P/EF/CPRO/AG
650NK	650	2012	→ 2014	FDB2048		left	XRAC/ST/P/EF/CP1				
650NK	650	2012	→ 2014	FDB2049		right	XRAC/ST/P/EF/CP1				
650NK	650	2012	→ 2014					FDB2012			ST/P/EF
650TK	650	2013	→ 2014	FDB2048		left	XRAC/ST/P/EF/CP1				
650TK	650	2013	→ 2014	FDB2049		right	XRAC/ST/P/EF/CP1				
650TK	650	2013	→ 2014					FDB2012			ST/P/EF
650TR	650	2013	→ 2014	FDB2048		left	XRAC/ST/P/EF/CP1				
650TR	650	2013	→ 2014	FDB2049		right	XRAC/ST/P/EF/CP1				
650TR	650	2013	→ 2014					FDB2012			ST/P/EF

CIMATTI

Gringo 50	50		→	FDB213			P				
Gringo 50	50	1985	→	FDB436			P				

CPI

GTR 50	50	2003	→	FDB2074			ST/SM/P/EF/CPRO/AG	FDB2057			EF/AG
HUSSAR 50	50	2001	→ 2002	FDB313			SG/P/EF	FSB731			
OLIVER 50	50	2003	→ 2005	FDB2191			EF	FSB731			
OLIVER / TNT / STUNT 50	50	2006	→	FDB2062			EF				
POPCORN 50	50	2003	→	FDB2191			EF	FSB732			
SUPERCROSS 50	50	2003	→	FDB2107			P	FDB2107			P
SUPERMOTO 50	50	2003	→	FDB2107			P	FDB2107			P
GTS 50 / 125 / 200	125	2002	→ 2003	FDB677			P/EF	FDB2057			EF/AG
HUSSAR 50 / 125 / 150	125	2003	→	FDB2191			EF	FSB731			
X-LARGE 125 / 150 / 200	125	2002	→	FDB2074			ST/SM/P/EF/CPRO/AG	FDB2074			ST/SM/P/EF/CPRO/AG

CZ

adaptable to front 85x20 drums			→	FSB936							
JAWA 125	125		→ 1974	FSB854				FSB854			
JAWA 125	125	1975	→	FSB855				FSB854			
SCRAMBLER CROSS 125	125		→	FSB955				FSB955			
JAWA 175	175		→ 1974	FSB854				FSB854			
JAWA 175	175	1975	→	FSB855				FSB854			
CZ 180	180	1993	→	FDB207			ST/P/EF/CP1				
JAWA 250	250		→ 1974	FSB854				FSB854			
JAWA 250 CROSS	250		→	FSB955				FSB955			
JAWA 250	250	1975	→	FSB855				FSB854			
SCRAMBLER CROSS 250	250		→	FSB955				FSB955			
JAWA 350	350		→ 1974	FSB854				FSB854			
JAWA 350	350	1975	→	FSB855				FSB854			
SCRAMBLER CROSS 350	350		→	FSB955				FSB955			
SCRAMBLER CROSS 380	380		→	FSB955				FSB955			
JAWA 400 CROSS	400		→	FSB955				FSB955			

DAELIM

"S" FIVE / "E" FIVE	50	2001	→	FDB250			SG/P/EF				
CORDI 50	50	2004	→	FDB250			SG/P/EF				
GZ 50 MESSAGE	50	2001	→ 2003	FDB250			SG/P/EF				
TAPO 50	50	1999	→ 2003	FDB250			SG/P/EF				
VIVO 50	50	1999	→	FDB250			SG/P/EF				
ALTINO 100	100	1999	→	FDB250			SG/P/EF				
DELFINO 100	100	1999	→ 2000	FDB250			SG/P/EF				

* It is recommended that in those applications where sintered pads are supplied as Original Equipment, replacement pads should also be of sintered composition.

** To avoid brake imbalance sintered pads fitted in rear calipers should only be used in combination with front calipers containing sintered pads.



CC KW FROM -> TO N° SET L/R COMPOUND N° SET L/R COMPOUND

...DAELIM

DELFINO 100	100	2001 → 2003	FDB250			SG/P/EF			
CITY ACE 110	110	2003 →	FDB312			ST/P/EF			
ALTINO 125	125	2001 →	FDB250			SG/P/EF			
HISTORY 125	125	2001 →	FDB250			SG/P/EF	FDB250		SG/P/EF
NS 125	125	2001 →	FDB250			SG/P/EF	FDB250		SG/P/EF
OTELLO / NS 125	125	1999 →	FDB250			SG/P/EF	FSB964		
ROADWIN 125	125	2004 →	FDB664			ST/P/EF	FDB631		ST/SM/SG/P/EF/AG
ROCKET 125	125	1999 → 2001	FDB664			ST/P/EF	FSB964		
VL 125 DAYSTAR	125	2003 →	FDB664			ST/P/EF			
VS 125	125	1995 → 1998	FDB250			SG/P/EF			
VS 125 CUSTOM	125	2001 →	FDB664			ST/P/EF	FSB964		
VT 125 MAGNA	125	1997 →	FDB664			ST/P/EF			

DERBI

all models 50	50	→ 1982	FSB809				FSB809		
all models 50 (disc brake)	50	1983 →	FDB2107			P			
AVENTURA 50	50	1996 →	FDB2107			P	FSB867		
BOX 50	50	1994 →	FSB867				FSB867		
COPPA 50 FDT	50	1986 →	FDB2107			P	FSB867		
COPPA 50 FDX	50	1987 →	FDB2107			P	FSB867		
DS 50 WORLD CHAMPION	50	1988 →	FDB2107			P	FSB867		
FD 50 JUMBO	50	1985 →	FDB2107			P	FSB867		
FDS 50	50	1986 →	FRP405			ST/SG/PRP/P/EF			
FENIX 50	50	1994 →	FRP405			ST/SG/PRP/P/EF	FSB867		
FURAX 50	50	1996 →	FDB2107			P	FSB867		
FY 50 JUMBO	50	1984 →					FSB867		
GP1 50	50	2002 → 2006	FRP405			ST/SG/PRP/P/EF			
GP1 50 OPEN	50	2007 →	FDB677			P/EF	FRP405		ST/SG/PRP/P/EF
GPR 50 R/REPLICA	50	1997 → 2005	FDB706			P	FRP405		ST/SG/PRP/P/EF
GPR 50 NAKED	50	2004 → 2006	FDB2074			ST/SM/P/EF/CPRO/AG	FDB539		SG/P/EF
GPR 50 Race Replica	50	2008 → 2009	FDB2074			ST/SM/P/EF/CPRO/AG	FRP405		ST/SG/PRP/P/EF
GPR 50	50	2010 →	FDB2201			ST	FDB384		P
HUNTER 50	50	1995 →	FRP405			ST/SG/PRP/P/EF	FSB777		
PADDOCK 50 ST	50	1996 →	FRP405			ST/SG/PRP/P/EF	FSB777		
PREDATOR 50	50	1998 →	FDB2107			P	FDB2107		P
PREDATOR 50 0.2	50	1999 →	FDB2107			P	FSB777		
PROGRESS 50	50	1997 →	FRP405			ST/SG/PRP/P/EF	FSB777		
RECORD 50	50	1998 →	FDB2107			P	FSB777		
RUNNER 50 2T Blacksoul	50	2011 →	FDB497			ST/SM/SG/P/EF	FDB680		ST/EF
SABANA 50	50	1990 →	FDB2107			P	FDB2107		P
SENDA 50	50	1994 →	FRP405			ST/SG/PRP/P/EF	FDB2107		P
SENDA DRD PRO 50	50	2005 → 2007	FDB2074			ST/SM/P/EF/CPRO/AG	FRP405		ST/SG/PRP/P/EF
SENDA DRD RACING R 50	50	2005 →	FDB677			P/EF	FRP405		ST/SG/PRP/P/EF
SENDA DRD Evo 50	50	2008 →	FDB2074			ST/SM/P/EF/CPRO/AG	FDB384		P
SENDA DRD Pro 50 SM	50	2008 →	FDB2074			ST/SM/P/EF/CPRO/AG	FDB2128		EF
SENDA DRS 50 Racing	50	2008 →	FRP405	2		ST/SG/PRP/P/EF	FRP405		ST/SG/PRP/P/EF
SENDA DRD Racing 50	50	2011 →	FDB497			ST/SM/SG/P/EF	FDB731		P
SENDA DRD X-Treme 50 SM	50	2011 →	FDB731			P	FDB731		P
SENDA DRD X-Treme 50 SM Limited	50	2013 →	FDB731			P	FDB731		P
SENDA Racing 50 SM	50	2018 →	FDB497			ST/SM/SG/P/EF	FDB731		P
SENDA X-Treme 50 R	50	2018 →	FDB731			P	FDB731		P
SPORT EDITION 50	50	1995 →	FRP405			ST/SG/PRP/P/EF			
SUPER MOTARD 50	50	2001 →	FRP405			ST/SG/PRP/P/EF	FRP405		ST/SG/PRP/P/EF
URBAN 50	50	1994 →	FSB867				FSB867		
VAMOS 50	50	1994 →	FDB2107			P	FSB777		
VAMOS 50 R	50	1995 →	FDB889			ST/EF	FSB777		
VAMOS 50 R	50	1996 →	FDB2107			P	FSB867		
VARIANT 50 SPORT R	50	1994 →	FDB2107			P	FSB867		
COPPA 75 SPORT	75	1985 →	FDB2107			P			
GPR 75 SPORT	75	1990 →	FDB697			EF	FDB694		ST/AG
TT8 75 (camme 10mm)	75	→ 1983	FSB867				FSB867		
TT8 75	75	1984 →	FDB207			ST/P/EF/CP1	FSB867		
YUMBO 75 RD-2 FDS	75	1987 →	FDB2107			P	FSB867		
GPR 80 CUP	80	2004 → 2007	FDB2074			ST/SM/P/EF/CPRO/AG	FDB539		SG/P/EF
GPR 80 CUP Criterium Derbi Malossi	80	2008 →	FDB2074			ST/SM/P/EF/CPRO/AG	FRP405		ST/SG/PRP/P/EF
BOULEVARD 125 / 150	125	2003 →	FDB2128			EF			
Cross City 125	125	2007 → 2008	FDB677			P/EF	FDB2128		EF
Cross City 125	125	2009 →	FDB2242			P/EF	FDB2128		EF
GPR 125 / NUDE (Radial Caliper)	125	2004 → 2009	FDB2201			ST	FRP405		ST/SG/PRP/P/EF
GPR 125	125	2010 →	FDB2201			ST	FDB384		P
Mulhacen 125 (4T) From ref no.: 7N001791	125	2007 → 2010	FDB2242			P/EF			
MULHACEN CAFE' 125	125	2008 →	FDB2074			ST/SM/P/EF/CPRO/AG	FDB384		P

* It is recommended that in those applications where sintered pads are supplied as Original Equipment, replacement pads should also be of sintered composition.

** To avoid brake imbalance sintered pads fitted in rear calipers should only be used in combination with front calipers containing sintered pads.



	CC	KW	FROM -> TO		N° SET	L/R	COMPOUND		N° SET	L/R	COMPOUND	
...DERBI												
SENDA 125 R 4T	125		2005 →	FDB677			P/EF		FRP405		ST/SG/PRP/P/EF	
SENDA BAJA 125 SM	125		2008 →	FDB677			P/EF		FDB2128		EF	
SENDA DRD 125	125		2010 →	FDB2074			ST/SM/P/EF/CPRO/AG		FDB384		P	
SONAR 125 (4T)	125		2010 → 2011	FDB2057			EF/AG		FSB954			
TERRA 125	125		2007 → 2008	FDB2242			P/EF		FDB384		P	
TERRA 125 ADVENTURE	125		2008 → 2009	FDB2242			P/EF		FDB2128		EF	
TERRA 125 ADVENTURE	125		2010 → 2013	FDB2242			P/EF		FDB384		P	
TT8 125 (camme 10 mm)	125		→ 1983	FSB867					FSB867			
TT8 125	125		1984 →	FSB867					FSB867			
Atlantis 150	150		2004 →	FDB2128			EF					
FUOCO 500 ie	500		2011 →	FDB497	2		ST/SM/SG/P/EF		FDB2128		EF	
MULHACEN CAFE' 659 Angel Nieto Lim. Ed.	659		2008 →	FDB2120			ZRAC/XRAC/ST		FDB2074		ST/SM/P/EF/CPRO/AG	
GP800	800		2010 → 2010	FDB2018	2		ZR/ST/SG/P/EF		FDB2142		ST/SM/EF/AG	
GP800	800		2011 →	FDB2018	2		ZR/ST/SG/P/EF		FDB2128		EF	
DUCATI												
502 SINGLE	50		1993 → 1999	FRP408	2		XRAC/ST/PRP/P/CPRO/CP1		FDB207		ST/P/EF/CP1	
502 SUPERMONO	50		1993 → 1999	FRP408	2		XRAC/ST/PRP/P/CPRO/CP1		FDB207		ST/P/EF/CP1	
250	250		→ 1976						FSB818			
250 DESMO	250		→ 1977	FDB148			ST/P		FSB876			
350	350		→ 1976						FSB818			
350 DESMO	350		→ 1977	FDB148			ST/P		FSB876			
350 S-GTL	350		1975 →	FDB207			ST/P/EF/CP1		FDB207		ST/P/EF/CP1	
350 SPORT GTV-SL-XL	350		1975 →	FDB207	2		ST/P/EF/CP1		FDB207		ST/P/EF/CP1	
350 F3	350		1986 →	FDB207	2		ST/P/EF/CP1		FDB207		ST/P/EF/CP1	
350 INDIANA	350		1987 →	FDB592			P		FDB207		ST/P/EF/CP1	
SCRAMBLER Sixty2 (KA)	399	30	2016 →	FDB2006			ST/P/EF		FDB2005		ST/SG/P/EF	
400 DESMO F3	400		1987 →	FDB207	2		ST/P/EF/CP1		FDB207		ST/P/EF/CP1	
400 MONSTER	400		1995 → 1997	FRP408			XRAC/ST/PRP/P/CPRO/CP1		FDB207		ST/P/EF/CP1	
400 MONSTER (JAPAN)	400		2000 →	FDB2042			ZRAC/XRAC/ST/P/EF/CPRO		FDB207		ST/P/EF/CP1	
Scrambler Sixty2	400	30	2017 →	FDB2006			ST/P/EF		FDB2005		ST/SG/P/EF	
SS 400 JUNIOR	400		1992 →	FRP408	2		XRAC/ST/PRP/P/CPRO/CP1		FDB207		ST/P/EF/CP1	
SS 400 NUDA	400		1992 →	FRP408	2		XRAC/ST/PRP/P/CPRO/CP1		FDB207		ST/P/EF/CP1	
450	450		→ 1976						FSB818			
500 GTL SPORT DESMO	500		1975 →	FDB207			ST/P/EF/CP1		FDB207		ST/P/EF/CP1	
500 GTV	500		1977 →	FDB207	2		ST/P/EF/CP1		FDB207		ST/P/EF/CP1	
500 PANTAH	500		1977 →	FDB207	2		ST/P/EF/CP1		FDB207		ST/P/EF/CP1	
S 500	500		1975 →	FDB207			ST/P/EF/CP1		FDB207		ST/P/EF/CP1	
550 SUPERMONO	550		1993 → 1999	FRP408	2		XRAC/ST/PRP/P/CPRO/CP1		FDB207		ST/P/EF/CP1	
600 SL	600		1976 →	FDB148	2		ST/P		FDB148		ST/P	
600 TL PANTAH	600		1976 →	FDB148	2		ST/P		FDB148		ST/P	
600 SUPERSPORT CARENATA	600		1994 → 1999	FRP408	2		XRAC/ST/PRP/P/CPRO/CP1		FDB207		ST/P/EF/CP1	
600 SUPERSPORT NUDA	600		1994 → 1999	FRP408	2		XRAC/ST/PRP/P/CPRO/CP1		FDB207		ST/P/EF/CP1	
M 600 MONSTER	600		1993 → 1999	FRP408			XRAC/ST/PRP/P/CPRO/CP1		FDB207		ST/P/EF/CP1	
M 600 MONSTER	600		2000 → 2000	FDB2042			ZRAC/XRAC/ST/P/EF/CPRO		FDB207		ST/P/EF/CP1	
M 600 MONSTER	600		2001 → 2002	FDB2042			ZRAC/XRAC/ST/P/EF/CPRO		FDB2074		ST/SM/P/EF/CPRO/AG	
M 620 MONSTER	620		2002 → 2003	FDB2042			ZRAC/XRAC/ST/P/EF/CPRO		FDB2074		ST/SM/P/EF/CPRO/AG	
M 620 MONSTER DARK (single/twin disc)	620		2003 →	FDB2042			ZRAC/XRAC/ST/P/EF/CPRO		FDB207		ST/P/EF/CP1	
MULTISTRADA DARK 620	620		2003 → 2005	FDB2018	2		ZR/ST/SG/P/EF		FDB207		ST/P/EF/CP1	
MULTISTRADA 620 (twin disc)	620		2005 → 2006	FDB2018	2		ZR/ST/SG/P/EF		FDB207		ST/P/EF/CP1	
MULTISTRADA 620 DARK (single disc)	620		2005 → 2006	FDB2042			ZRAC/XRAC/ST/P/EF/CPRO		FDB2074		ST/SM/P/EF/CPRO/AG	
SPORT 620	620		2003 →	FDB2042			ZRAC/XRAC/ST/P/EF/CPRO		FDB2074		ST/SM/P/EF/CPRO/AG	
650 INDIANA	650		1986 → 1987	FDB207	2		ST/P/EF/CP1		FDB207		ST/P/EF/CP1	
650 DESMO	650		1987 →	FDB108	2		ST/P/EF/CPRO		FDB207		ST/P/EF/CP1	
650 INDIANA	650		1987 →	FDB592			P		FDB207		ST/P/EF/CP1	
MONSTER 695	695		2006 → 2008	FDB2018	2		ZR/ST/SG/P/EF		FDB2074		ST/SM/P/EF/CPRO/AG	
MONSTER 696	696		2008 → 2013	FDB2042	2		ZRAC/XRAC/ST/P/EF/CPRO		FDB2074		ST/SM/P/EF/CPRO/AG	
748 BIPOSTO	748		1995 → 1997	FRP408	2		XRAC/ST/PRP/P/CPRO/CP1		FDB207		ST/P/EF/CP1	
748 RACING CLIENTI	748		1995 → 1997	FDB2007	2		CPRO/CP1		FDB207		ST/P/EF/CP1	
748 BIPOSTO	748		1998 →	FDB2042	2		ZRAC/XRAC/ST/P/EF/CPRO		FDB207		ST/P/EF/CP1	
748 RACING CLIENTI	748		1998 →	FDB2042	2		ZRAC/XRAC/ST/P/EF/CPRO		FDB207		ST/P/EF/CP1	
748 SPS	748		1998 →	FDB2042	2		ZRAC/XRAC/ST/P/EF/CPRO		FDB2074		ST/SM/P/EF/CPRO/AG	
748 / 748R / 748S	748		2001 →	FDB2120	2		ZRAC/XRAC/ST		FDB2074		ST/SM/P/EF/CPRO/AG	
749 / 749R / 749S / 749 DARK	749		2003 →	FDB2120	2		ZRAC/XRAC/ST		FDB2074		ST/SM/P/EF/CPRO/AG	
750 SPORT	750		1974 → 1976	FDB342			P/CPRO					
750 SUPERSPORT	750		1976 → 1991	FDB108	2		ST/P/EF/CPRO		FDB108		ST/P/EF/CPRO	
750 F1 DESMO	750		1986 →	FDB108	2		ST/P/EF/CPRO		FDB207		ST/P/EF/CP1	
750 ENDURANCE	750		1987 →	FRP408	2		XRAC/ST/PRP/P/CPRO/CP1		FDB108		ST/P/EF/CPRO	
750 LAGUNA SECA	750		1987 →	FRP408	2		XRAC/ST/PRP/P/CPRO/CP1		FDB108		ST/P/EF/CPRO	
750 PASO	750		1987 →	FDB108	2		ST/P/EF/CPRO		FDB108		ST/P/EF/CPRO	
750 SPORT	750		1989 → 2000	FDB108	2		ST/P/EF/CPRO		FDB108		ST/P/EF/CPRO	
750 SUPERSPORT	750		1992 → 1997	FRP408	2		XRAC/ST/PRP/P/CPRO/CP1		FDB207		ST/P/EF/CP1	

* It is recommended that in those applications where sintered pads are supplied as Original Equipment, replacement pads should also be of sintered composition.

** To avoid brake imbalance sintered pads fitted in rear calipers should only be used in combination with front calipers containing sintered pads.



CC KW FROM -> TO N° SET L/R COMPOUND N° SET L/R COMPOUND

...DUCATI

750 SUPERSPORT	750	1998	→ 2002	FDB2042	2		ZRAC/XRAC/ST/P/EF/CPRO	FDB2074			ST/SM/P/EF/CPRO/AG
750 SPORT	750	2001	→ 2002	FDB2042	2		ZRAC/XRAC/ST/P/EF/CPRO	FDB2074			ST/SM/P/EF/CPRO/AG
M 750 MONSTER	750	1996	→ 1999	FRP408	2		XRAC/ST/PRP/PI/CPRO/CP1	FDB207			ST/P/EF/CP1
M 750 MONSTER	750	2000	→ 2000	FDB2042	2		ZRAC/XRAC/ST/P/EF/CPRO	FDB207			ST/P/EF/CP1
M 750 MONSTER	750	2001	→ 2002	FDB2042	2		ZRAC/XRAC/ST/P/EF/CPRO	FDB2074			ST/SM/P/EF/CPRO/AG
SS 750 NUDA	750	1992	→ 1998	FRP408	2		XRAC/ST/PRP/PI/CPRO/CP1	FDB207			ST/P/EF/CP1
SS 750 CARENATA	750	1993	→ 1998	FRP408	2		XRAC/ST/PRP/PI/CPRO/CP1	FDB207			ST/P/EF/CP1
HYPERMOTARD 796	796	2010	→	FDB2042	2		ZRAC/XRAC/ST/P/EF/CPRO	FDB2074			ST/SM/P/EF/CPRO/AG
MONSTER 796 (ABS Std)	796	2011	→ 2013	FDB2042	2		ZRAC/XRAC/ST/P/EF/CPRO	FDB2074			ST/SM/P/EF/CPRO/AG
800 SUPERSPORT	800	2003	→	FDB2042	2		ZRAC/XRAC/ST/P/EF/CPRO	FDB2074			ST/SM/P/EF/CPRO/AG
MONSTER 800	800	2003	→ 2006	FDB2042	2		ZRAC/XRAC/ST/P/EF/CPRO	FDB207			ST/P/EF/CP1
MONSTER S2R 800	800	2007	→	FDB2018	2		ZR/ST/SG/P/EF	FDB207			ST/P/EF/CP1
Monster 797	803	54	2017	→	FDB2265	2	ST/EF/CPRO	FDB2005			ST/SG/P/EF
Monster 797 plus	803	54	2018	→	FDB2265	2	ST/EF/CPRO	FDB2005			ST/SG/P/EF
SCRAMBLER Urban Enduro	803	2015	→	FDB2265	2		ST/EF/CPRO	FDB2005			ST/SG/P/EF
SCRAMBLER Classic (K1)	803	23	2015	→	FDB2265	2	ST/EF/CPRO	FDB2005			ST/SG/P/EF
SCRAMBLER Classic (K1)	803	34	2015	→	FDB2265	2	ST/EF/CPRO	FDB2005			ST/SG/P/EF
SCRAMBLER Full Throttle	803	54	2015	→	FDB2265	2	ST/EF/CPRO	FDB2005			ST/SG/P/EF
SCRAMBLER Icon	803	54	2015	→	FDB2265	2	ST/EF/CPRO	FDB2005			ST/SG/P/EF
SCRAMBLER Classic (K1)	803	55	2015	→	FDB2265	2	ST/EF/CPRO	FDB2005			ST/SG/P/EF
Scrambler Caf	803	54	2017	→	FDB2265	2	ST/EF/CPRO	FDB2005			ST/SG/P/EF
Scrambler Desert Sled	803	54	2017	→	FDB2265	2	ST/EF/CPRO	FDB2005			ST/SG/P/EF
Scrambler Mach 2.0	803	54	2018	→	FDB2265	2	ST/EF/CPRO	FDB2005			ST/SG/P/EF
Scrambler Street Classic	803	54	2018	→	FDB2265	2	ST/EF/CPRO	FDB2005			ST/SG/P/EF
HYPERMOTARD 821 (ABS Std)	821	2013	→	FDB2265	2		ST/EF/CPRO	FDB2074			ST/SM/P/EF/CPRO/AG
HYPERMOTARD SP 821 (ABS Std)	821	2013	→	FDB2265	2		ST/EF/CPRO	FDB2074			ST/SM/P/EF/CPRO/AG
HYPERSTRADA 821 (ABS Std)	821	2013	→	FDB2265	2		ST/EF/CPRO	FDB2074			ST/SM/P/EF/CPRO/AG
MONSTER 821 DARK	821	2015	→	FDB2265	2		ST/EF/CPRO	FDB2074			ST/SM/P/EF/CPRO/AG
MONSTER 821 Stripe	821	2015	→	FDB2265	2		ST/EF/CPRO	FDB2074			ST/SM/P/EF/CPRO/AG
MONSTER 821 (M7)	821	35	2015	→	FDB2265	2	ST/EF/CPRO	FDB2074			ST/SM/P/EF/CPRO/AG
MONSTER 821 (M6)	821	82	2015	→	FDB2265	2	ST/EF/CPRO	FDB2074			ST/SM/P/EF/CPRO/AG
Monster 821	821	80	2018	→	FDB2265	2	ST/EF/CPRO	FDB2074			ST/SM/P/EF/CPRO/AG
848	848	2008	→	FDB2042	2		ZRAC/XRAC/ST/P/EF/CPRO	FDB2074			ST/SM/P/EF/CPRO/AG
Superbike 848 EVO	848	2011	→	FDB2260	2		XRAC/ST/CPRO	FDB2074			ST/SM/P/EF/CPRO/AG
Streetfighter 848	849	2014	→	FDB2042	2		ZRAC/XRAC/ST/P/EF/CPRO	FDB2074			ST/SM/P/EF/CPRO/AG
851 all models	851	1988	→ 1992	FRP408	2		XRAC/ST/PRP/PI/CPRO/CP1	FDB207			ST/P/EF/CP1
860 GT	860	1974	→ 1976	FDB108	2		ST/P/EF/CPRO	FDB108			ST/P/EF/CPRO
860 GTS	860	65	1975	→ 1976	FDB108	2	ST/P/EF/CPRO	FDB108			ST/P/EF/CPRO
880 RACING	880	1994	→ 1995	FDB2007	2		CPRO/CP1	FDB207			ST/P/EF/CP1
888 all models	888	1992	→ 1995	FRP408	2		XRAC/ST/PRP/PI/CPRO/CP1	FDB207			ST/P/EF/CP1
899 Panigale (ABS Std)	898	2014	→	FDB2265	2		ST/EF/CPRO	FDB2074			ST/SM/P/EF/CPRO/AG
900 all models	900	1992	→ 1998	FRP408	2		XRAC/ST/PRP/PI/CPRO/CP1	FDB207			ST/P/EF/CP1
900 I.E. PASO	900	1992	→ 1998	FRP408	2		XRAC/ST/PRP/PI/CPRO/CP1	FDB207			ST/P/EF/CP1
900 SUPERMONO DESMO 4	900	1993	→ 1995	FRP408	2		XRAC/ST/PRP/PI/CPRO/CP1	FDB207			ST/P/EF/CP1
FE 900 SUPERSPORT	900	1998	→	FDB2042	2		ZRAC/XRAC/ST/P/EF/CPRO	FDB2074			ST/SM/P/EF/CPRO/AG
M 900 MONSTER	900	1993	→ 1999	FRP408	2		XRAC/ST/PRP/PI/CPRO/CP1	FDB207			ST/P/EF/CP1
M 900 MONSTER I.E.	900	2000	→	FDB2042	2		ZRAC/XRAC/ST/P/EF/CPRO	FDB207			ST/P/EF/CP1
M 900 MONSTER	900	2001	→	FDB2042	2		ZRAC/XRAC/ST/P/EF/CPRO	FDB2074			ST/SM/P/EF/CPRO/AG
906 PASO	906	1989	→ 1990	FDB108	2		ST/P/EF/CPRO	FDB108			ST/P/EF/CPRO
916 STRADA / SENNA / SP / SPS	916	1994	→ 1997	FRP408	2		XRAC/ST/PRP/PI/CPRO/CP1	FDB207			ST/P/EF/CP1
916 RACING CLIENTI	916	1995	→ 1998	FDB2007	2		CPRO/CP1	FDB207			ST/P/EF/CP1
916 STRADA	916	1998	→	FDB2042	2		ZRAC/XRAC/ST/P/EF/CPRO	FDB2074			ST/SM/P/EF/CPRO/AG
916 SUPERSPORT 4	916	1998	→	FDB2042	2		ZRAC/XRAC/ST/P/EF/CPRO	FDB2074			ST/SM/P/EF/CPRO/AG
916 ST2	916	2001	→ 2002	FDB2042	2		ZRAC/XRAC/ST/P/EF/CPRO	FDB2074			ST/SM/P/EF/CPRO/AG
M 916 MONSTER S4	916	2001	→ 2002	FDB2042	2		ZRAC/XRAC/ST/P/EF/CPRO	FDB207			ST/P/EF/CP1
HYPERMOTARD 939 SP	937	83	2016	→	FDB2265	2	ST/EF/CPRO	FDB2074			ST/SM/P/EF/CPRO/AG
HYPERMOTARD 939 (BA)	937	83	2016	→	FDB2265	2	ST/EF/CPRO	FDB2074			ST/SM/P/EF/CPRO/AG
Hypermotard 950	937	84	2019	→	FDB2265	2	ST/EF/CPRO	FDB2074			ST/SM/P/EF/CPRO/AG
Hypermotard 950 SP	937	84	2019	→	FDB2265	2	ST/EF/CPRO	FDB2074			ST/SM/P/EF/CPRO/AG
HYPERSTRADA 939	937	83	2016	→	FDB2265	2	ST/EF/CPRO	FDB2074			ST/SM/P/EF/CPRO/AG
Multistrada 950	937	83	2017	→	FDB2265	2	ST/EF/CPRO	FDB2018			ZR/ST/SG/P/EF
Multistrada 950 S	937	83	2019	→	FDB2265	2	ST/EF/CPRO	FDB2018			ZR/ST/SG/P/EF
Supersport	937	81	2017	→	FDB2265	2	ST/EF/CPRO	FDB2074			ST/SM/P/EF/CPRO/AG
Supersport S	937	81	2017	→	FDB2265	2	ST/EF/CPRO	FDB2074			ST/SM/P/EF/CPRO/AG
944 ST2	944	1997	→ 2002	FDB2042	2		ZRAC/XRAC/ST/P/EF/CPRO	FDB2074			ST/SM/P/EF/CPRO/AG
944 SUPERSPORT 2	944	1998	→ 2002	FDB2042	2		ZRAC/XRAC/ST/P/EF/CPRO	FDB2074			ST/SM/P/EF/CPRO/AG
944 ST4	944	1999	→	FDB2042	2		ZRAC/XRAC/ST/P/EF/CPRO	FDB2074			ST/SM/P/EF/CPRO/AG
959 Panigale	955	110	2016	→	FDB2265	2	ST/EF/CPRO	FDB2074			ST/SM/P/EF/CPRO/AG
959 Panigale Corse	955	110	2018	→	FDB2265	2	ST/EF/CPRO	FDB2074			ST/SM/P/EF/CPRO/AG
Panigale V2	955	114	2020	→	FDB2265	2	ST/EF/CPRO				
Panigale V2	955	114	2020	→				FDB2074		left	ST/SM/P/EF/CPRO/AG
ST3 992	992	2004	→	FDB2042	2		ZRAC/XRAC/ST/P/EF/CPRO	FDB2074			ST/SM/P/EF/CPRO/AG
996 SPS / S	996	1998	→	FDB2042	2		ZRAC/XRAC/ST/P/EF/CPRO	FDB2074			ST/SM/P/EF/CPRO/AG
996 BIPOSTO	996	1999	→	FDB2042	2		ZRAC/XRAC/ST/P/EF/CPRO	FDB207			ST/P/EF/CP1

* It is recommended that in those applications where sintered pads are supplied as Original Equipment, replacement pads should also be of sintered composition.

** To avoid brake imbalance sintered pads fitted in rear calipers should only be used in combination with front calipers containing sintered pads.

1020

DUCATI



	CC	KW	FROM -> TO		N° SET	L/R	COMPOUND		N° SET	L/R	COMPOUND	
...DUCATI												
996 R TESTA STRETTA	996	2001	→	FDB2120	2		ZRAC/XRAC/ST	FDB2074			ST/SM/P/EF/CPRO/AG	
ST4 / ST4 ABS 996	996	2001	→	FDB2042	2		ZRAC/XRAC/ST/P/EF/CPRO	FDB2074			ST/SM/P/EF/CPRO/AG	
998 BIPOSTO	998	2002	→	FDB2042	2		ZRAC/XRAC/ST/P/EF/CPRO	FDB2074			ST/SM/P/EF/CPRO/AG	
998 R	998	2002	→	FDB2120	2		ZRAC/XRAC/ST	FDB207			ST/P/EF/CP1	
998 S	998	2002	→	FDB2042	2		ZRAC/XRAC/ST/P/EF/CPRO	FDB207			ST/P/EF/CP1	
998 SFE	998	2003	→	FDB2120	2		ZRAC/XRAC/ST	FDB207			ST/P/EF/CP1	
Panigale V4R	998	162	2019	→	FDB2260	2	XRAC/ST/CPRO	FDB2074			ST/SM/P/EF/CPRO/AG	
999 R / S	999	2003	→	FDB2120	2		ZRAC/XRAC/ST	FDB2074			ST/SM/P/EF/CPRO/AG	
1000 all models	1000	1984	→	FDB108	2		ST/P/EF/CPRO	FDB108			ST/P/EF/CPRO	
Desmosedici RR (Lim. Ed.)	1000	2008	→	FDB2260	2		XRAC/ST/CPRO	FDB2074			ST/SM/P/EF/CPRO/AG	
GT 1000	1000	2006	→ 2007	FDB2006	2		ST/P/EF	FDB2074			ST/SM/P/EF/CPRO/AG	
Sportclassic GT 1000 / SPORT 1000S / Touring	1000	2008	→	FDB2006	2		ST/P/EF	FDB2005			ST/SG/P/EF	
MONSTER 1000	1000	2003	→ 2006	FDB2042	2		ZRAC/XRAC/ST/P/EF/CPRO	FDB207			ST/P/EF/CP1	
MONSTER S4R /S4RS 1000	1000	2006	→ 2007	FDB2120	2		ZRAC/XRAC/ST	FDB207			ST/P/EF/CP1	
MONSTER S2R 1000	1000	2007	→ 2007	FDB2042	2		ZRAC/XRAC/ST/P/EF/CPRO	FDB207			ST/P/EF/CP1	
MONSTER S2R 1000	1000	2008	→	FDB2042	2		ZRAC/XRAC/ST/P/EF/CPRO	FDB2074			ST/SM/P/EF/CPRO/AG	
MONSTER S4R /S4RS 1000	1000	2008	→	FDB2042	2		ZRAC/XRAC/ST/P/EF/CPRO	FDB2074			ST/SM/P/EF/CPRO/AG	
MONSTER S4R S Testastretta/tricolore	1000	2008	→	FDB2120	2		ZRAC/XRAC/ST	FDB207			ST/P/EF/CP1	
MULTISTRADA 1000 / 1000 DS / 1000S DS	1000	2003	→ 2006	FDB2042	2		ZRAC/XRAC/ST/P/EF/CPRO	FDB2074			ST/SM/P/EF/CPRO/AG	
PAUL SMART 1000 Limited Edition	1000	2007	→	FDB2006	2		ST/P/EF	FDB2074			ST/SM/P/EF/CPRO/AG	
SPORT 1000	1000	2006	→	FDB2006	2		ST/P/EF	FDB2074			ST/SM/P/EF/CPRO/AG	
SUPERSPORT 1000 DS	1000	2003	→	FDB2042	2		ZRAC/XRAC/ST/P/EF/CPRO	FDB2074			ST/SM/P/EF/CPRO/AG	
Scrambler 1100	1079	63	2018	→	FDB2265	2	ST/EF/CPRO	FDB2005			ST/SG/P/EF	
Scrambler 1100 Special	1079	63	2018	→	FDB2265	2	ST/EF/CPRO	FDB2005			ST/SG/P/EF	
Scrambler 1100 Sport	1079	63	2018	→	FDB2265	2	ST/EF/CPRO	FDB2005			ST/SG/P/EF	
1098 /1098 S / 1098 R Bayliss Lim. Ed.	1098	2007	→	FDB2260	2		XRAC/ST/CPRO	FDB2074			ST/SM/P/EF/CPRO/AG	
STREETFIGHTER S	1099	2011	→	FDB2260	2		XRAC/ST/CPRO	FDB2074			ST/SM/P/EF/CPRO/AG	
HYPERMOTARD 1100	1100	2007	→	FDB2042	2		ZRAC/XRAC/ST/P/EF/CPRO	FDB2074			ST/SM/P/EF/CPRO/AG	
HYPERMOTARD 1100S	1100	2007	→	FDB2260	2		XRAC/ST/CPRO	FDB2074			ST/SM/P/EF/CPRO/AG	
HYPERMOTARD 1100 EVO	1100	2010	→	FDB2042	2		ZRAC/XRAC/ST/P/EF/CPRO	FDB2074			ST/SM/P/EF/CPRO/AG	
HYPERMOTARD 1100 SP / EVO SP / Corse ed.	1100	2010	→	FDB2260	2		XRAC/ST/CPRO	FDB2074			ST/SM/P/EF/CPRO/AG	
MONSTER 1100 / 1100 S	1100	2009	→	FDB2042	2		ZRAC/XRAC/ST/P/EF/CPRO	FDB2074			ST/SM/P/EF/CPRO/AG	
MULTISTRADA 1100 / 1100 S / S Touring / S Sport	1100	2007	→	FDB2042	2		ZRAC/XRAC/ST/P/EF/CPRO	FDB2074			ST/SM/P/EF/CPRO/AG	
Streetfighter / S	1100	2010	→	FDB2260	2		XRAC/ST/CPRO	FDB2074			ST/SM/P/EF/CPRO/AG	
Panigale V4	1103	157	2018	→	FDB2260	2	XRAC/ST/CPRO	FDB2074			ST/SM/P/EF/CPRO/AG	
Panigale V4 S	1103	157	2018	→	FDB2260	2	XRAC/ST/CPRO	FDB2074			ST/SM/P/EF/CPRO/AG	
Panigale V4 Speciale	1103	157	2018	→	FDB2260	2	XRAC/ST/CPRO	FDB2074			ST/SM/P/EF/CPRO/AG	
Panigale V4S Corse	1103	157	2018	→	FDB2260	2	XRAC/ST/CPRO	FDB2074			ST/SM/P/EF/CPRO/AG	
Street fighter V4 S	1103	153	2020	→	FDB2260	2	XRAC/ST/CPRO	FDB2074			ST/SM/P/EF/CPRO/AG	
Street fighter V4 S	1103	153	2020	→	FDB2260	2		FDB2074	left		ST/SM/P/EF/CPRO/AG	
1199 Panigale S (ABS Std)	1198	2012	→	FDB2260	2		XRAC/ST/CPRO	FDB2074			ST/SM/P/EF/CPRO/AG	
1199 Panigale (ABS Std)	1198	2014	→	FDB2260	2		XRAC/ST/CPRO	FDB2074			ST/SM/P/EF/CPRO/AG	
1199 Panigale R (ABS Std)	1198	2013	→ 2017	FDB2260	2		XRAC/ST/CPRO	FDB2074			ST/SM/P/EF/CPRO/AG	
DIAVEL 1200 (ABS Std)	1198	2011	→	FDB2260	2		XRAC/ST/CPRO	FDB2006			ST/P/EF	
DIAVEL CARBON 1200 (ABS Std)	1198	2014	→	FDB2260	2		XRAC/ST/CPRO	FDB2006			ST/P/EF	
DIAVEL DARK 1200 (ABS Std)	1198	2014	→	FDB2260	2		XRAC/ST/CPRO	FDB2006			ST/P/EF	
DIAVEL STRADA 1200 (ABS Std)	1198	2014	→	FDB2260	2		XRAC/ST/CPRO	FDB2006			ST/P/EF	
DIAVEL TITANIUM 1200 (ABS Std)	1198	2015	→	FDB2260	2		XRAC/ST/CPRO	FDB2006			ST/P/EF	
Diavel Diesel	1198	112	2018	→	FDB2260	2	XRAC/ST/CPRO	FDB2006			ST/P/EF	
MULTISTRADA 1200S Touring (ABS Std)	1198	2010	→	FDB2042	2		ZRAC/XRAC/ST/P/EF/CPRO	FDB2074			ST/SM/P/EF/CPRO/AG	
MULTISTRADA 1200S Granturismo (ABS Std)	1198	2014	→	FDB2042	2		ZRAC/XRAC/ST/P/EF/CPRO	FDB2074			ST/SM/P/EF/CPRO/AG	
MULTISTRADA 1200S Pikes peak (ABS Std)	1198	2014	→	FDB2042	2		ZRAC/XRAC/ST/P/EF/CPRO	FDB2074			ST/SM/P/EF/CPRO/AG	
MULTISTRADA 1200	1198	110	2014	→	FDB2042	2	ZRAC/XRAC/ST/P/EF/CPRO	FDB2074			ST/SM/P/EF/CPRO/AG	
MULTISTRADA 1200S	1198	2015	→	FDB2260	2		XRAC/ST/CPRO	FDB2018			ZR/ST/SG/P/EF	
MULTISTRADA 1200S D air	1198	2015	→	FDB2260	2		XRAC/ST/CPRO	FDB2018			ZR/ST/SG/P/EF	
MULTISTRADA 1200	1198	112	2015	→	FDB2042	2	ZRAC/XRAC/ST/P/EF/CPRO	FDB2074			ST/SM/P/EF/CPRO/AG	
MULTISTRADA 1200	1198	73	2015	→	FDB2042	2	ZRAC/XRAC/ST/P/EF/CPRO	FDB2074			ST/SM/P/EF/CPRO/AG	
MULTISTRADA 1200 Pikes peak	1198	2016	→	FDB2260	2		XRAC/ST/CPRO	FDB2018			ZR/ST/SG/P/EF	
MULTISTRADA 1200 ENDURO	1198	112	2016	→	FDB2265	2	ST/EF/CPRO	FDB2018			ZR/ST/SG/P/EF	
SUPERBIKE 1198 / S / S Corse / R / SP	1198	2009	→	FDB2260	2		XRAC/ST/CPRO	FDB2074			ST/SM/P/EF/CPRO/AG	
1199 Panigale Superleggera	1199	2014	→	FDB2260	2		XRAC/ST/CPRO	FDB2074			ST/SM/P/EF/CPRO/AG	
MONSTER 1200	1200	108	2014	→	FDB2265	2	ST/EF/CPRO	FDB2074			ST/SM/P/EF/CPRO/AG	
MONSTER 1200S	1200	108	2014	→	FDB2260	2	XRAC/ST/CPRO	FDB2074			ST/SM/P/EF/CPRO/AG	
MONSTER 1200S Stripe	1200	2015	→	FDB2260	2		XRAC/ST/CPRO	FDB2074			ST/SM/P/EF/CPRO/AG	
MONSTER 1200R	1200	112	2016	→	FDB2260	2	XRAC/ST/CPRO	FDB2074			ST/SM/P/EF/CPRO/AG	
Diavel 1260	1262	117	2019	→	FDB2265	2	ST/EF/CPRO	FDB2006			ST/P/EF	
Diavel 1260 S	1262	117	2019	→	FDB2260	2	XRAC/ST/CPRO	FDB2006			ST/P/EF	
Multistrada 1260	1262	116	2018	→	FDB2265	2	ST/EF/CPRO	FDB2018			ZR/ST/SG/P/EF	
Multistrada 1260 Pikes peak	1262	116	2018	→	FDB2260	2	XRAC/ST/CPRO	FDB2018			ZR/ST/SG/P/EF	
Multistrada 1260 S	1262	116	2018	→	FDB2260	2	XRAC/ST/CPRO	FDB2018			ZR/ST/SG/P/EF	
Multistrada 1260 S D air	1262	116	2018	→	FDB2260	2	XRAC/ST/CPRO	FDB2018			ZR/ST/SG/P/EF	
Multistrada 1260 Enduro	1262	116	2019	→	FDB2265	2	ST/EF/CPRO	FDB2018			ZR/ST/SG/P/EF	
Multistrada 1260 S Grantour	1262	116	2020	→	FDB2260	2	XRAC/ST/CPRO	FDB2018				
Multistrada 1260 S Grantour	1262	116	2020	→				FDB2018	left		ZR/ST/SG/P/EF	

* It is recommended that in those applications where sintered pads are supplied as Original Equipment, replacement pads should also be of sintered composition.

** To avoid brake imbalance sintered pads fitted in rear calipers should only be used in combination with front calipers containing sintered pads.



CC KW FROM -> TO N° SET L/R COMPOUND N° SET L/R COMPOUND

...DUCATI

XDIAVEL	1262	2016	→	FDB2265	2		ST/EF/CPRO	FDB2006			ST/P/EF
XDIAVEL S	1262	2016	→	FDB2260	2		XRAC/ST/CPRO	FDB2006			ST/P/EF
1299 Panigale (ABS Std)	1285	2015	→	FDB2260	2		XRAC/ST/CPRO	FDB2074			ST/SM/P/EF/CPRO/AG
1299 Panigale S (ABS Std)	1285	2015	→	FDB2260	2		XRAC/ST/CPRO	FDB2074			ST/SM/P/EF/CPRO/AG
1299 Panigale R Final Edition	1285	154	2018	→	FDB2260	2	XRAC/ST/CPRO	FDB2074			ST/SM/P/EF/CPRO/AG
1299 Superleggera	1299	2017	→	FDB2260	2		XRAC/ST/CPRO	FDB2074			ST/SM/P/EF/CPRO/AG

EBR

1190RX	1190	2014	→ 2015	FDB2240			ST				
1190SX	1190	2014	→ 2015	FDB2240			ST				

FANTIC

BIG WHEEL 50	50	1994	→	FDB636			P/EF	FDB828			ST/P
CABALLERO 50 REG. SUPER 6 M	50		→ 1983	FSB897				FSB897			
CABALLERO 50 RC	50	1990	→	FDB207			ST/P/EF/CP1	FDB694			ST/AG
Caballero Motard	50	2010	→	FDB2314			EF				
Caballero Regularita'	50	2010	→	FDB2314			EF				
CASA 50	50	1975	→	FSB898				FSB898			
COMPETIZIONE 50	50	1975	→	FSB898				FSB898			
50E (2T) Enduro Casa	50	2013	→	FDB2242			P/EF	FDB2139			SG/P/EF
ENDURO 50 COMPETITION	50		→ 1982	FSB898				FSB898			
ENDURO 50 REPLICA	50	1980	→	FSB898				FSB898			
ENDURO 50	50	1983	→	FSB897				FSB897			
50ER (2T) Enduro Competizione	50	2013	→	FDB2242			P/EF	FDB2139			SG/P/EF
FAST 50	50	1988	→	FDB697			EF	FSB898			
GRAN TURISMO 50 FOUR (FM. 200)	50		→ 1982	FSB898				FSB898			
GRINTA 50	50	1995	→	FDB636			P/EF	FDB828			ST/P
ISSIMO 50 (alloy wheels)	50		→	FSB877				FSB877			
ISSIMO 50 (spoke wheels)	50		→	FSB902				FSB902			
ISSIMO 50	50	1984	→	FSB877				FSB877			
KOALA 50	50	1987	→	FDB694			ST/AG	FDB694			ST/AG
LEADER 50	50	1995	→	FDB636			P/EF	FDB828			ST/P
50M (2T) Motard Casa	50	2013	→	FDB2242			P/EF	FDB2139			SG/P/EF
50MR (2T) Motard Competizione	50	2013	→	FDB2242			P/EF	FDB2139			SG/P/EF
OASIS 50 .1	50	1986	→	FDB697			EF	FDB624			AG
OASIS 50 .1 RALLY	50	1986	→	FDB697			EF				
OASIS 50 .1 E.S.	50	1987	→	FDB697			EF	FDB624			AG
OASIS 50 .1 K.S.	50	1987	→	FDB697			EF				
OASIS 50 .1 KICK	50	1987	→	FDB697			EF				
PONY 50	50	1993	→	FSB731				FSB731			
PONY 50 SR	50	1993	→	FDB636			P/EF	FSB731			
QUEENIE 50	50	1995	→	FDB636			P/EF	FSB731			
R 6 50 SUPER	50		→	FSB897				FSB897			
RAIDER 50	50	1981	→	FDB731			P				
RAIDER 50 .1	50	1986	→	FDB731			P				
REPLICA 50	50		→ 1980	FSB898				FSB898			
SPRINTER 50 3V. R (FM. 248)	50	1983	→	FSB910				FSB910			
SPRINTER 50	50	1984	→	FSB910				FSB910			
STRADA 50 SUPER SIX	50	1973	→	FDB213			P	FSB898			
STRADA 50 (FM. 240)	50	1982	→	FDB731			P	FSB898			
TRIAL 50 I SERIE (mozzi centrali)	50		→ 1983	FSB907				FSB897			
TRIAL 50 .1 (FM.268)	50	1986	→	FDB436			P				
TRIAL 50 .1 H2O	50	1987	→	FDB436			P				
TRIAL 50 JUNIOR	50	1987	→					FSB887			
TRIAL 50 .5	50	1989	→	FRP405			ST/SG/PRP/P/EF	FRP405			ST/SG/PRP/P/EF
TRIAL 50 .7	50	1990	→	FRP405			ST/SG/PRP/P/EF	FRP405			ST/SG/PRP/P/EF
TRIAL 50 .9	50	1991	→	FRP405			ST/SG/PRP/P/EF	FRP405			ST/SG/PRP/P/EF
TX 180 E (49cc/2T) Regularita Casa 50E	50	2011	→ 2013	FDB2242			P/EF	FDB2139			SG/P/EF
TX 180 ER (49cc/2T) Regularita Competizione 50ER	50	2011	→ 2013	FDB2242			P/EF	FDB2139			SG/P/EF
TX 180 ES (49cc/2T) Regularita Scuderia 50ES	50	2011	→ 2013	FDB2242			P/EF	FDB2139			SG/P/EF
TX 180 MR (49cc/2T) Motard Competizione 50MR	50	2011	→ 2013	FDB2242			P/EF	FDB2139			SG/P/EF
TX 180 SM (49cc/2T) Motard Casa 50M	50	2011	→ 2013	FDB2242			P/EF	FDB2139			SG/P/EF
CROSS 80 COMPETITION	80		→ 1981	FSB898				FSB898			
CROSS 80 COMPETITION	80	1981	→	FSB898				FSB901			
ENDURO 80	80	1980	→	FSB898				FSB901			
TRIAL 80	80		→ 1983	FSB897				FSB897			
Caballero Motard 4T	125	2010	→	FDB2314			EF				
Caballero Regularita' 4T	125	2010	→	FDB2314			EF				
Caballero Flat Track	125	2017	→	FDB2266			ST/EF	FDB2139			SG/P/EF
Caballero Scrambler	125	2017	→	FDB2266			ST/EF	FDB2139			SG/P/EF

* It is recommended that in those applications where sintered pads are supplied as Original Equipment, replacement pads should also be of sintered composition.

** To avoid brake imbalance sintered pads fitted in rear calipers should only be used in combination with front calipers containing sintered pads.



	CC	KW	FROM -> TO		N° SET	L/R	COMPOUND		N° SET	L/R	COMPOUND
...FANTIC											
CROSS 125 COMPETITION	125		1980 →	FSB898				FSB901			
125 E (4T)Enduro Casa	125		2013 →	FDB2242			P/EF	FDB2139			SG/P/EF
ENDURO 125	125		1980 →	FSB898				FSB901			
125 M (4T)Motard Casa	125		2013 →	FDB2242			P/EF	FDB2139			SG/P/EF
125 MR (4T)Motard Competizione	125		2013 →	FDB2242			P/EF	FDB2139			SG/P/EF
RAIDER 125	125		1983 →	FDB694			ST/AG				
RAIDER 125 LC	125		1983 →	FDB694			ST/AG				
REGOLARITA' 125	125		1981 →	FSB898				FSB901			
Regolarita' Competizione	125		2008 →	FDB2314			EF				
RSX 125	125		1981 →	FSB847				FSB847			
SPORT 125	125		→ 1984	FDB696			AG	FSB876			
SPORT 125 MK II	125		→ 1984	FDB696			AG	FSB876			
SPORT 125 HP1 (FM.265)	125		1985 →	FDB624			AG	FSB781			
SPORT 125 MK II (f.a.tel.1706338)	125		1985 →	FDB696			AG	FSB781			
STRADA 125 (FM. 4000-A)	125		1983 →	FDB696			AG	FSB876			
TR 125 CR (2T) Cross Competizione	125		2013 →	FDB2242			P/EF	FDB2139			SG/P/EF
TR 125 MR (2T) Motard Competizione	125		2013 →	FDB2242			P/EF	FDB2139			SG/P/EF
TRIAL 125 7 DAYS mozzi conici	125		→	FSB898				FSB898			
TRIAL 125 7 DAYS(mozzi centrali)	125		→	FSB897				FSB847			
TRIAL 125 I SERIE. (tEL. grig. m. cen)	125		→	FSB907				FSB897			
TRIAL 125 II SERIE (tel.rosso m.cen)	125		→	FSB897				FSB897			
TRIAL 125 III SERIE (mozzi conici)	125		→	FSB898				FSB898			
TRIAL 125 PROFESSIONAL (FM.237)	125		1983 →	FSB898				FSB898			
TRIAL 125 .1 Progress 1	125		1986 → 1986	FDB436			P	FSB898			
TRIAL 125 .1 Progress 2	125		1986 →	FDB436			P	FSB898			
TRIAL 125 .3 PROFESSIONAL (FM 361)	125		1987 →	FDB436			P	FDB436			P
TRIAL 125 .5	125		1989 →	FRP405			ST/SG/PRP/P/EF	FRP405			ST/SG/PRP/P/EF
TRIAL 125 .9	125		1991 →	FRP405			ST/SG/PRP/P/EF	FRP405			ST/SG/PRP/P/EF
TZ 125 CS (2T) Caballero Cross	125		2011 → 2012	FDB2242			P/EF	FDB2139			SG/P/EF
TZ 125 ES (2T) Regolarita Scuderia	125		2011 → 2012	FDB2242			P/EF	FDB2139			SG/P/EF
TZ 125 SM (2T) Caballero Motard	125		2011 → 2012	FDB2242			P/EF	FDB2139			SG/P/EF
TZ 170 E (125 E / 4T) Regolarita Casa	125		2011 → 2013	FDB2242			P/EF	FDB2139			SG/P/EF
TZ 170 ER (125 ER / 4T) Caballero Reg. Comp.	125		2011 → 2013	FDB2242			P/EF	FDB2139			SG/P/EF
TZ 170 SM (125 SM/ 4T) Motard Casa	125		2011 → 2013	FDB2242			P/EF	FDB2139			SG/P/EF
Caballero Motard 4T	200		2010 →	FDB2314			EF				
Caballero Regolarita' 4T	200		2010 →	FDB2314			EF				
200 ER (4T)Enduro Competizione	200		2011 →	FDB2242			P/EF	FDB2139			SG/P/EF
200 MR (4T)Motard Competizione	200		2011 →	FDB2242			P/EF	FDB2139			SG/P/EF
TRIAL 200 Progress 1	200		1986 →	FDB436			P	FSB898			
TZ 200 ER (200 ER / 4T) Caballero Reg. Comp.	200		2011 → 2013	FDB2242			P/EF	FDB2139			SG/P/EF
TZ 200 MR (200 MR / 4T) Motard	200		2011 → 2013	FDB2242			P/EF	FDB2139			SG/P/EF
TRIAL 201 Progress2	201		1986 →	FDB436			P	FSB898			
TRIAL 240 SEVEN DAYS (FM. 289)	240		1986 →					FSB898			
TRIAL 240 (FM 363)	240		1987 →	FDB436			P	FDB436			P
TRIAL 241 PROFESSIONAL	241		1986 →	FDB436			P	FSB898			
Caballero Flat Track 250	249		2019 →	FDB2266			ST/EF	FDB2139			SG/P/EF
Caballero Scrambler 250	249		2019 →	FDB2266			ST/EF	FDB2139			SG/P/EF
TRIAL 249	249		1990 →	FRP405			ST/SG/PRP/P/EF	FRP405			ST/SG/PRP/P/EF
COACH 250	250		1991 →	FRP405			ST/SG/PRP/P/EF	FSB898			
K-ROO 250	250		1991 →	FRP405			ST/SG/PRP/P/EF	FRP405			ST/SG/PRP/P/EF
K-ROO 250	250		1993 →	FDB2107			P	FDB2107			P
RAIDER 250 (FM. 259)	250		1985 →	FDB438			P/EF	FSB759			
TF 250 ES (4T)	250		2011 → 2013	FDB2242			P/EF	FDB2139			SG/P/EF
TR 250 ES (2T) Enduro Six Day	250		2013 →	FDB2242			P/EF	FDB2139			SG/P/EF
TR 300 ES (2T) Enduro Six Day	300		2013 →	FDB2242			P/EF	FDB2139			SG/P/EF
TRIAL 300 (FM. 403)	300		1984 →					FSB898			
TZ 300 ES Regolarita Scuderia	300		2011 → 2012	FDB2242			P/EF	FDB2139			SG/P/EF
TRIAL 301 Progress 1 (FM. 266)	301		1985 →	FDB436			P	FSB898			
TRIAL 301 Progress 2	301		1986 →	FDB436			P	FSB898			
TRIAL 303 (FM 364)	303		1987 →	FDB436			P	FDB436			P
TRIAL 305	305		1989 →	FRP405			ST/SG/PRP/P/EF	FRP405			ST/SG/PRP/P/EF
TRIAL 307	307		1990 → 1991	FRP405			ST/SG/PRP/P/EF	FRP405			ST/SG/PRP/P/EF
TRIAL 200 (FM. 350)	350		1978 →	FSB898				FSB898			
TRIAL 240 (FM. 450)	450		→ 1983	FSB898				FSB898			
Caballero Flat Track	500		2017 →	FDB2265			ST/EF/CPRO	FDB2005			ST/SG/P/EF
Caballero Scrambler	500		2017 →	FDB2265			ST/EF/CPRO	FDB2005			ST/SG/P/EF
Caballero Rally	500		2019 →	FDB2265			ST/EF/CPRO	FDB2005			ST/SG/P/EF
FB MINARELLI											
MR 80	80		→	FDB2107			P	FSB827			

* It is recommended that in those applications where sintered pads are supplied as Original Equipment, replacement pads should also be of sintered composition.

** To avoid brake imbalance sintered pads fitted in rear calipers should only be used in combination with front calipers containing sintered pads.



CC KW FROM -> TO N° SET L/R COMPOUND N° SET L/R COMPOUND

GARELLI

BASIC 50 (alloy wheel fondermonte)	50		→	FSB877				FSB877			
BASIC 50 (alloy wheels grimeca)	50		→	FSB908				FSB908			
BASIC 50 (spoke wheel)	50		→	FSB902				FSB902			
BIG WHEEL 50	50	1993	→ 1994	FDB636				FDB828			ST/P
BIP RACING 50	50	1994	→	FDB636				FDB636			
CICLONE 50 I SERIE (spoke wheel)	50		→	FSB907				FSB907			
CICLONE 50 II SERIE (alloy wheels)	50		→	FSB907				FSB907			
CICLONE 50 N DE LUXE SELF MIX L.C	50		→	FDB213			P	FSB907			
CICLONE 50 N/N DE LUXE SELF MIX L	50		→	FSB907				FSB907			
EUREKA 50	50		→	FSB902				FSB902			
FORMUNO 50 (from frame N. 2701552)	50	1987	→	FSB906				FSB908			
FORMUNO 50 (up to frame N. 2701551)	50	1987	→					FSB908			
FORMUNO 50 F1 RAID	50	1987	→					FSB908			
GRAN TURISMO 50 (alloy wheel)	50		→	FSB907				FSB907			
GRINTA	50	1995	→	FDB636			P/EF	FSB732			
GULP 50	50		→	FSB902				FSB902			
JUNIOR 50 TURISMO (spoke wheel)	50		→	FSB910				FSB910			
KL 50 SV	50		→	FSB907				FSB907			
KRS 50	50	2002	→	FDB2190			EF	FSB777			
NOI 50 (alloy wheels fondermonte)	50		→	FSB877				FSB877			
NOI 50 (alloy wheels grimeca)	50		→	FSB908				FSB908			
NOI 50 (spoke wheel)	50		→	FSB902				FSB902			
NOI 50 MATIC	50		→	FSB902				FSB902			
PONY 50	50	1992	→	FSB732				FSB732			
PONY 50 SR	50	1992	→ 1995	FDB636			P/EF	FSB732			
QUEENIE	50	1995	→	FDB636			P/EF	FSB732			
SAHEL 50	50	1991	→	FDB697			EF	FRP405			ST/SG/PRP/P/EF
SUPER VIP 50	50		→	FSB902				FSB902			
TEAM MATIC 50	50	1988	→	FSB870				FSB908			
TIGER 50 XLE	50	1986	→	FDB697			EF	FDB436			P
URKA 50	50	1991	→	FDB207			ST/P/EF/CP1				
VIP 50 (alloy wheels grimeca)	50		→	FSB908				FSB908			
VIP 50 (spoke wheel)	50		→	FSB902				FSB902			
VIP 50 alloy wheels (fondermonte)	50		→	FSB877				FSB877			
SAHEL 80	80	1989	→	FDB697			EF	FRP405			ST/SG/PRP/P/EF
FREELAND 125	125	2002	→	FDB2190			EF	FSB777			
GTA 125	125	1986	→ 1986	FDB694	2		ST/AG	FSB781			
GTA 125	125	1986	→ 2000	FDB694	2		ST/AG	FDB694			ST/AG
JOKER 125	125	2002	→	FDB2190			EF				
TIGER 125 XR	125		→	FDB207			ST/P/EF/CP1	FSB911			
TIGER 125 XRD	125		→	FDB207			ST/P/EF/CP1	FSB911			
TIGER 125 XLE	125	1986	→ 1986	FDB438			P/EF	FDB624			AG
TSR 125	125		→	FDB696			AG	FSB876			
TSR 125 SELF MIX	125		→	FDB205			P	FSB876			
FREELAND 150	150	2002	→	FDB2190			EF	FSB777			
JOKER 150	150	2002	→	FDB2190			EF				
TRIAL 320	320		→ 1985	FSB898				FSB898			
TRIAL 320	320	1986	→	FRP405			ST/SG/PRP/P/EF	FSB898			

GASGAS

EC BOY 50	50	2001	→	FDB2103			P	FDB2103			P
EC ROOKIE 50	50	2001	→	FDB438			P/EF	FDB2103			P
TXT 50 BOY	50	2004	→	FDB2107			P	FDB2107			P
MC 65	65	2005	→	FDB2103			P	FDB2103			P
ENDURCROSS 80	80	1994	→	FDB2018			ZR/ST/SG/P/EF	FDB314			ST/SG/P/EF
TXT 80 ROOKIE	80	2002	→ 2013	FDB2103			P				
TXT 80 ROOKIE	80	2002	→ 2005					FDB2103			P
TXT 80 KADET PRO	80	2006	→ 2014	FDB2127			SG	FDB2127			SG
TXT 80 ROOKIE	80	2006	→ 2013					FDB2127			SG
TXT 80 PRO Racing	80	2015	→ 2020	FDB2103			P	FDB2127			SG
CROSS 125	125	1994	→	FDB2018			ZR/ST/SG/P/EF	FDB438			P/EF
DELTA 125	125	1991	→	FDB2107			P				
EC / MC 125	125	1996	→ 1999	FDB2018			ZR/ST/SG/P/EF	FDB2005			ST/SG/P/EF
EC / MC 125	125	2000	→	FDB892			ZR/SG/P/EF/CPRO	FDB539			SG/P/EF
ENDURCROSS 125	125	1994	→	FDB2018			ZR/ST/SG/P/EF	FDB314			ST/SG/P/EF
JT 12 125	125	1995	→	FDB2107			P	FDB2107			P
PAMPERA 125	125	1996	→	FDB2107			P	FDB2107			P
TRIAL 125	125	1991	→	FDB2107			P				
TT 125 ENDURCROSS	125	1993	→	FDB2018			ZR/ST/SG/P/EF	FDB438			P/EF
TT 125	125	1995	→	FDB2018			ZR/ST/SG/P/EF	FDB2107			P
TXT 125	125	2001	→ 2003	FDB2103			P	FDB2103			P
TXT 125 / 200 / 250 / 280 / 300	125	2004	→	FDB2109			P	FDB2127			SG

* It is recommended that in those applications where sintered pads are supplied as Original Equipment, replacement pads should also be of sintered composition.

** To avoid brake imbalance sintered pads fitted in rear calipers should only be used in combination with front calipers containing sintered pads.



CC KW FROM -> TO N° SET L/R COMPOUND



N° SET L/R COMPOUND

...GASGAS

JTR 140 CONTACT	140	1996	→	FDB2107			P	FDB2107		P
JT 16 150	150	1995	→	FDB2107			P	FDB2107		P
JT 160	160	1995	→	FDB2107			P	FDB2107		P
EC 200	200	2001	→	FDB892			ZR/SG/P/EF/CPRO	FDB539		SG/P/EF
TXT 200	200	2000	→ 2003	FDB2103			P	FDB2103		P
TXT 249	249	2001	→ 2003	FDB2103			P	FDB2103		P
CROSS 250	250	1995	→	FDB2018			ZR/ST/SG/P/EF	FDB314		ST/SG/P/EF
EC / MC 250	250	1996	→ 1999	FDB2018			ZR/ST/SG/P/EF	FDB2005		ST/SG/P/EF
EC / MC 250	250	2000	→	FDB892			ZR/SG/P/EF/CPRO	FDB539		SG/P/EF
ENDURCROSS 250	250	1995	→	FDB2018			ZR/ST/SG/P/EF			
JT 25 250	250	1991	→	FDB2107			P	FDB2107		P
JT 250 CONTACT	250	1994	→	FDB2107			P	FDB2107		P
JTR 250 CONTACT	250	1996	→	FDB2107			P	FDB2107		P
PAMPERA 250	250	1996	→ 2001	FRP405			ST/SG/PRP/P/EF	FRP405		ST/SG/PRP/P/EF
PAMPERA 250	250	2002	→	FDB677			P/EF	FDB2103		P
T 25 250 CONTACT	250	1993	→	FDB2107			P	FDB2107		P
TT 250	250	1995	→	FDB2018			ZR/ST/SG/P/EF	FDB2005		ST/SG/P/EF
TXT 250	250	2000	→	FDB2103			P	FDB2103		P
JTR 270 CONTACT	270	1996	→	FDB2107			P	FDB2107		P
TX 270	270		→ 1998	FRP405			ST/SG/PRP/P/EF	FRP405		ST/SG/PRP/P/EF
TXT 280	280	2000	→	FDB2103			P	FDB2103		P
EC / MC 300	300	1996	→ 1999	FDB2018			ZR/ST/SG/P/EF	FDB2005		ST/SG/P/EF
EC / MC 300	300	2000	→	FDB892			ZR/SG/P/EF/CPRO	FDB539		SG/P/EF
JT 32 320	320	1991	→	FDB2107			P	FDB2107		P
TXT 321	321	2000	→	FDB2103			P	FDB2103		P
HALLEY 325 PCX	325	1987	→	FDB436			P	FDB436		P
TRIAL 327	327	1989	→	FDB2107			P	FDB2107		P
GASGAS 350	350		→	FDB2107			P	FDB2107		P
JT 350	350	1995	→	FDB2107			P	FDB2107		P
JTR 370 CONTACT	370	1996	→	FDB2107			P	FDB2107		P
EC 400	400	2001	→	FDB892			ZR/SG/P/EF/CPRO	FDB539		SG/P/EF
FSE 450 SM	450	2003	→	FRP408			XRAC/ST/PRP/P/CPRO/CP1	FDB539		SG/P/EF
FSE 450	450	2004	→	FDB892			ZR/SG/P/EF/CPRO	FDB539		SG/P/EF

GENERIC

Zion 125	125	2008	→	FDB2305			EF			
----------	-----	------	---	---------	--	--	----	--	--	--

GILERA

503 50	50	1991	→	FDB436			P	FDB436		P
BULLIT 50	50	1990	→	FDB436			P			
CB 1 50	50		→	FSB902				FSB889		
CBA 50	50		→	FSB902				FSB889		
CBA 50	50	1986	→	FSB902				FSB889		
DNA 50	50	2001	→	FDB677			P/EF	FDB2057		EF/AG
EAGLET 50	50	1996	→	FDB697			EF	FDB828		ST/P
EASY MOVING 50	50	1995	→ 1996	FDB680			ST/EF	FSB895		
ECO 50	50		→	FSB902				FSB889		
GSM 50 / H @ K 50	50	2000	→ 2003	FRP405			ST/SG/PRP/P/EF	FRP405		ST/SG/PRP/P/EF
ICE 50	50	2001	→ 2003	FDB680			ST/EF			
NRG 50	50	1995	→ 2003	FDB680			ST/EF	FSB895		
R1 50	50	1990	→ 1998					FSB834		
RALLY 50	50	1987	→ 1990					FSB844		
RC 50 TOP RALLY	50	1990	→ 1995	FDB828			ST/P	FDB828		ST/P
RCR 50	50	2005	→	FRP405			ST/SG/PRP/P/EF	FRP405		ST/SG/PRP/P/EF
RUNNER 50	50	1997	→ 1998	FDB680			ST/EF	FSB938		
RUNNER 50 SP / SKP	50	1999	→ 2005	FDB680			ST/EF	FDB2057		EF/AG
RUNNER 50 SP / SKP	50	2006	→	FDB2142			ST/SM/EF/AG	FDB2057		EF/AG
SMT 50	50	2005	→	FRP405			ST/SG/PRP/P/EF	FRP405		ST/SG/PRP/P/EF
STALKER 50	50	1997	→	FDB680			ST/EF	FDB2057		EF/AG
STORM 50	50	1994	→ 1995	FDB680			ST/EF	FSB895		
TREND 50	50	1989	→ 1992	FSB910				FSB889		
TYPHOON 50	50	1993	→ 1995	FDB680			ST/EF	FSB895		
TYPHOON 50	50	1996	→	FDB680			ST/EF	FSB940		
TG1 80	80		→	FDB205			P	FSB901		
TG2 80	80		→	FDB205			P	FSB901		
TG3 80	80		→	FDB205			P	FSB901		
TYPHOON 80	80	1995	→	FDB680			ST/EF	FSB895		
GIUBILEO 98	98		→	FSB847				FSB897		
GIUBILEO 124	124		→	FSB847				FSB897		
APACHE 125	125	1991	→	FDB499			P	FDB383		SG/P/EF

* It is recommended that in those applications where sintered pads are supplied as Original Equipment, replacement pads should also be of sintered composition.

** To avoid brake imbalance sintered pads fitted in rear calipers should only be used in combination with front calipers containing sintered pads.



CC KW FROM -> TO N° SET L/R COMPOUND



N° SET L/R COMPOUND

...GILERA

Model	CC	KW	FROM -> TO	N° SET	L/R	COMPOUND	N° SET	L/R	COMPOUND
ARCORE 125	125		→	FSB901			FSB897		
ARIZONA 125	125	1983	→	FDB207		ST/P/EF/CP1	FSB838		
ARIZONA HAWK 125	125	1986	→	FDB438		P/EF	FSB838		
CMM APTS 125	125	1987	→	FDB438		P/EF	FDB207		ST/P/EF/CP1
CRONO 125	125	1991	→	FDB498		XRAC/ST/P	FDB207		ST/P/EF/CP1
CX 125	125	1991	→	FDB498		XRAC/ST/P	FDB207		ST/P/EF/CP1
DNA 125	125	2000	→ 2003	FDB677		P/EF	FDB2115		P/EF
E1 125	125		→	FSB898			FSB901		
E1 125 COMPETIZIONE	125		→	FSB898			FSB901		
ER 125	125	1987	→	FDB438		P/EF	FSB838		
FAST BIKE 125	125	1987	→	FDB438		P/EF	FDB207		ST/P/EF/CP1
GFR 125	125	1993	→	FDB498		XRAC/ST/P	FDB207		ST/P/EF/CP1
GR1 125	125		→	FDB205		P	FSB901		
HX 125 LC	125	1983	→	FDB207		ST/P/EF/CP1	FSB911		
KK 125 APTS	125	1987	→	FDB438		P/EF	FDB207		ST/P/EF/CP1
KZ 125	125	1986	→	FDB438		P/EF	FDB207		ST/P/EF/CP1
KZ 125 ENDURANCE	125	1988	→	FDB438		P/EF	FDB207		ST/P/EF/CP1
MX 1 125	125	1988	→	FDB498		XRAC/ST/P	FDB207		ST/P/EF/CP1
MX R 125	125	1990	→	FDB498		XRAC/ST/P	FDB207		ST/P/EF/CP1
R1 125 S	125	1988	→	FDB438		P/EF	FDB207		ST/P/EF/CP1
RC 125 RALLY	125	1987	→	FDB438		P/EF	FSB838		
RC 125 TOP RALLY	125	1989	→	FDB499		P	FDB383		SG/P/EF
RRT 125 NEBRASKA	125	1987	→	FDB438		P/EF	FSB838		
RRT 125 NEBRASKA (tubeless tires)	125	1987	→ 2000	FDB438	2	P/EF	FSB844		
RTX 125	125		→	FDB438		P/EF	FSB838		
RUNNER 125	125		→ 1999	FDB677		P/EF	FSB954		
RUNNER 125 FX - SP	125	2000	→	FDB677		P/EF	FDB2057		EF/AG
RUNNER 125 VX 4T	125	2001	→	FDB677		P/EF	FDB2115		P/EF
RV 125	125	1983	→	FDB696		AG	FSB876		
RV 125 ES	125	1987	→	FDB438		P/EF	FSB876		
RX 125	125	1984	→	FDB207		ST/P/EF/CP1	FSB838		
SP 01 125	125	1989	→	FDB498		XRAC/ST/P	FDB207		ST/P/EF/CP1
SP 02 125	125	1990	→	FDB498		XRAC/ST/P	FDB207		ST/P/EF/CP1
TG1 125	125		→	FDB205		P	FSB876		
TG2 125	125		→	FDB205		P	FSB876		
TG3 125	125		→	FDB205		P	FSB876		
TYPHOON 125	125	1995	→	FDB680		ST/EF	FSB938		
TYPHOON 125 XR KAT	125	2000	→	FDB680		ST/EF	FSB938		
XR1 125	125	1988	→	FDB438		P/EF	FDB207		ST/P/EF/CP1
XR2 125	125	1989	→	FDB438		P/EF	FDB207		ST/P/EF/CP1
ARCORE 150	150		→				FSB901		
DNA 180	180	2001	→ 2002	FDB677		P/EF	FDB2115		P/EF
RUNNER 180	180		→ 1998	FDB677		P/EF	FSB954		
RUNNER 180 FXR - SP	180	1999	→	FDB677		P/EF	FDB2057		EF/AG
RUNNER 180 VXR 4T	180	2001	→	FDB677		P/EF	FDB2115		P/EF
ARIZONA HAWK 200	200	1986	→	FDB438		P/EF	FSB838		
ER 200	200	1987	→	FDB438		P/EF	FSB838		
FAST BIKE 200	200	1987	→	FDB438		P/EF	FDB207		ST/P/EF/CP1
RTX 200	200	1986	→	FDB438		P/EF	FSB838		
RUNNER 200 VXR	200	2004	→	FDB677		P/EF	FDB2115		P/EF
RV 200	200	1985	→	FDB696		AG	FDB207		ST/P/EF/CP1
RV 200 ES	200	1987	→	FDB438		P/EF	FDB207		ST/P/EF/CP1
RX 200	200	1985	→	FDB207		ST/P/EF/CP1	FSB838		
RX 200 ARIZONA	200	1985	→	FDB207		ST/P/EF/CP1	FSB838		
T4 200	200		→	FDB205		P	FSB876		
T4C 200	200		→	FDB205		P	FSB876		
T4S 200	200		→	FDB205		P	FSB876		
HX 250 LC	250	1983	→	FDB207		ST/P/EF/CP1	FSB834		
NEXUS 250 IE	250	2007	→	FDB2142		ST/SM/EF/AG	FDB2142		ST/SM/EF/AG
NGR 250	250	1985	→	FDB694	2	ST/AG	FDB207		ST/P/EF/CP1
RC 250 RALLY	250	1987	→	FDB438		P/EF	FDB207		ST/P/EF/CP1
RX 250 ARIZONA RALLY	250	1986	→	FDB207		ST/P/EF/CP1	FSB834		
NEXUS 300 (M35)	300	16	2008 → 2013	FDB2142		ST/SM/EF/AG	FDB2142		ST/SM/EF/AG
DAKOTA 350	350	1986	→	FDB438		P/EF	FSB759		
ER 350	350	1987	→	FDB438		P/EF	FSB759		
XRT 350	350	1990	→	FDB438		P/EF	FDB207		ST/P/EF/CP1
DAKOTA 500	500	1987	→	FDB438		P/EF			
ER 500	500	1987	→	FDB438		P/EF	FSB759		
FUOCO 500 RC/ie	500	2007	→	FDB2057	2	EF/AG	FDB2142		ST/SM/EF/AG
NEXUS 500	500	2004	→	FDB2018	2	ZR/ST/SG/P/EF	FDB2074		ST/SM/EF/CPRO/AG
SATURNO 500 PIUMA	500	1990	→	FRP408		XRAC/ST/PRP/PI/CPRO/CP1	FDB207		ST/P/EF/CP1
RC 600	600	1989	→ 1990	FDB499		P	FDB383		SG/P/EF
RC 600 TOP RALLY	600	1990	→	FDB499		P	FDB383		SG/P/EF
RC 600	600	1991	→	FDB529		P	FDB383		SG/P/EF

* It is recommended that in those applications where sintered pads are supplied as Original Equipment, replacement pads should also be of sintered composition.

** To avoid brake imbalance sintered pads fitted in rear calipers should only be used in combination with front calipers containing sintered pads.



CC KW FROM -> TO N° SET L/R COMPOUND



N° SET L/R COMPOUND

...GILERA

RC 600 NORD WEST	600	1991	→	FDB529			P	FDB383			SG/P/EF
RC 600 R	600	1991	→	FDB529			P	FDB383			SG/P/EF
XRT 600	600	1988	→	FDB438			P/EF	FDB207			ST/P/EF/CP1
GP800	800	2008	→	FDB2018	2		ZR/ST/SG/P/EF	FDB2142			ST/SM/EF/AG

GOGORO

Gogoro II (Electric)	6	2018	→	FDB2310			EF				
----------------------	---	------	---	---------	--	--	----	--	--	--	--

GREKAV

EIKE 505	50		→	FDB2154			P				
----------	----	--	---	---------	--	--	---	--	--	--	--

HARLEY DAVIDSON

Livewire		2020	→	FDB2265	2		ST/EF/CPRO	FDB2074			ST/SM/P/EF/CPRO/AG
XG 500 Street	549	2014	→	FDB2018			ZR/ST/SG/P/EF	FDB2018			ZR/ST/SG/P/EF
XG 750A Street Rod	749	2018	→	FDB2006	2		ST/P/EF	FDB2018			ZR/ST/SG/P/EF
XG 750 Street	749	2014	→ 2015	FDB2018			ZR/ST/SG/P/EF	FDB2018			ZR/ST/SG/P/EF
XG 750 Street	749	2016	→	FDB2006			ST/P/EF	FDB2018			ZR/ST/SG/P/EF
XL 883 EVO	883	1986	→ 1987	FDB352			ST/P	FDB335			PRP/P
XL 883 EVO	883	1987	→ 1999	FDB352			ST/P	FDB2001			SG/PRP/P
XL 883 R Sportster	883	2000	→ 2003	FDB2097			ST/PRP/P	FDB2097			ST/PRP/P
XL53C Sportster Custom	883	2000	→ 2003	FDB2097			ST/PRP/P	FDB2097			ST/PRP/P
XL 883 R 100th Anniversary Edition	883	2003	→ 2003	FDB2097	2		ST/PRP/P	FDB2097			ST/PRP/P
XL 883	883	2004	→ 2008	FDB2179			ST/P	FDB2180			ST/P
XL 883 C Sportster Custom	883	2004	→ 2008	FDB2179			ST/P	FDB2180			ST/P
XL 883 L Low	883	2004	→ 2010	FDB2179			ST/P	FDB2180			ST/P
XL 883 SPORTSTER R	883	2005	→ 2013	FDB2179			ST/P	FDB2180			ST/P
XL 883 N Iron	883	39 2009	→ 2010	FDB2179			ST/P	FDB2180			ST/P
XL 883 L Superlow	883	2011	→ 2013	FDB2179			ST/P	FDB2180			ST/P
XL 883 L (Cast Wheels)	883	2014	→ 2017	FDB2299			ST/P				
XL 883 L Super Low (Cast Wheels)	883	2014	→					FDB2111			ST/P/EF
XL 883 N	883	2016	→	FDB2299			ST/P				
XL 883 N Iron (Cast Wheel)	883	2011	→ 2013	FDB2179			ST/P	FDB2180			ST/P
XL 883 N Iron (Cast Wheel)	883	2014	→ 2017	FDB2299			ST/P	FDB2111			ST/P/EF
XL 883 R Roadster (Cast Wheel)	883	2011	→ 2013	FDB2179	2		ST/P	FDB2180			ST/P
XL 883 R Roadster (Cast Wheel)	883	2014	→	FDB2299	2		ST/P	FDB2111			ST/P/EF
XLH Sportster 883 Huggler	883	1992	→ 1993	FDB352			ST/P	FDB2001			SG/PRP/P
XLH 883 Sportster	883	2000	→ 2003	FDB2097			ST/PRP/P	FDB2097			ST/PRP/P
XLH 883 Sportster Huggler	883	2000	→ 2003	FDB2097			ST/PRP/P	FDB2097			ST/PRP/P
XLX	883	1983	→	FDB333			PRP/P	FDB335			PRP/P
XLX	883	1984	→ 1985	FDB352			ST/P	FDB335			PRP/P
XLCR 1000 Cafe Racer	1000	1977	→ 1978	FDB333			PRP/P	FDB334			P
XLCH 1000 Sportster	1000	1978	→ 1979	FDB333			PRP/P	FDB334			P
XLH 1000 Sportster	1000	1978	→ 1981	FDB333			PRP/P	FDB334			P
XLH 1000 Sportster	1000	1982	→ 1983	FDB333			PRP/P	FDB335			PRP/P
XLH 1000 Sportster	1000	1984	→ 1985	FDB352			ST/P	FDB335			PRP/P
XLS 1000 Roadster	1000	1979	→ 1981	FDB333			PRP/P	FDB334			P
XLS 1000 Roadster	1000	1982	→ 1983	FDB333			PRP/P	FDB335			PRP/P
XLS 1000 Roadster	1000	1984	→ 1985	FDB352			ST/P	FDB335			PRP/P
XR 1000	1000	1983	→ 1985	FDB352			ST/P	FDB335			PRP/P
XL 1100 EVO	1100	1986	→	FDB352			ST/P	FDB335			PRP/P
VRSC V-Rod	1130	2000	→ 2005	FDB2097	2		ST/PRP/P	FDB2097			ST/PRP/P
VRSC V-Rod	1130	2006	→ 2008	FDB2210	2		ST/P	FDB2210			ST/P
VRSCD Night Rod (Cast Wheel)	1130	2006	→	FDB2210	2		ST/P	FDB2210			ST/P
VRSCR Street Rod	1130	2006	→	FDB2210	2		ST/P	FDB2210			ST/P
XL 1200 EVO	1200		→ 1999	FDB352			ST/P	FDB2001			SG/PRP/P
XL 1200 C Sportster Custom	1200	2000	→ 2003	FDB2097			ST/PRP/P	FDB2097			ST/PRP/P
XL 1200 S Sportster Sport	1200	2000	→ 2003	FDB2097	2		ST/PRP/P	FDB2097			ST/PRP/P
XL 1200 C Sportster Custom	1200	2004	→ 2010	FDB2179			ST/P	FDB2180			ST/P
XL 1200 R Sportster Roadster	1200	2004	→ 2008	FDB2179	2		ST/P	FDB2180			ST/P
XL 1200 L Sportster Low (Cast Wheel)	1200	2007	→ 2011	FDB2179			ST/P	FDB2180			ST/P
XL 1200 L Sportster Low (Spoke Wheel)	1200	2007	→ 2011	FDB2179			ST/P	FDB2180			ST/P
XL 50 50th Anniversary Sportster	1200	2007	→ 2007	FDB2179			ST/P	FDB2180			ST/P
XL 1200 N Nightster (Spoke wheel)	1200	2008	→ 2012	FDB2179			ST/P	FDB2180			ST/P
XL 1200 X - Forty Eight	1200	49 2010	→ 2013	FDB2179			ST/P	FDB2180			ST/P
XL 1200 C Sportster Custom (Cast& Spoke Wheels)	1200	2011	→ 2013	FDB2179			ST/P	FDB2180			ST/P
XL 1200 V - Seventy Two	1200	2012	→ 2013	FDB2179			ST/P	FDB2180			ST/P
XL 1200 C Custom (Spoke Wheels)	1200	2014	→ 2017	FDB2299			ST/P	FDB2111			ST/P/EF
XL 1200 T Superlow	1200	2014	→	FDB2299			ST/P	FDB2111			ST/P/EF
XL 1200 V - Seventy Two	1200	2014	→	FDB2299			ST/P	FDB2111			ST/P/EF

HARLEY DAVIDSON

* It is recommended that in those applications where sintered pads are supplied as Original Equipment, replacement pads should also be of sintered composition.

** To avoid brake imbalance sintered pads fitted in rear calipers should only be used in combination with front calipers containing sintered pads.



CC KW FROM -> TO N° SET L/R COMPOUND N° SET L/R COMPOUND

...HARLEY DAVIDSON

XL 1200 X - Forty Eight	1200	50	2014 → 2017	FDB2299			ST/P	FDB2111			ST/P/EF
XL 1200 CA Custom Limited A	1200		2015 →					FDB2111			ST/P/EF
XL 1200 CB Custom Limited B	1200		2015 →					FDB2111			ST/P/EF
XLH 1200 Sporter	1200		2000 → 2003	FDB2097			ST/PRP/P	FDB2097			ST/PRP/P
XR 1200	1200		2008 → 2010	FDB2114	2		XRAC/ST/P	FDB2180			ST/P
XR 1200 X	1200		2010 → 2012	FDB2114	2		XRAC/ST/P	FDB2180			ST/P
XL 1200 NS Iron	1202		2019 →	FDB2299	2		ST/P	FDB2111			ST/P/EF
XL 1200 XS Forty Eight Special	1202		2019 →	FDB2299	2		ST/P	FDB2111			ST/P/EF
XL 1200 CX Roadster	1202		2016 → 2017	FDB2299	2		ST/P	FDB2111			ST/P/EF
VRSCAW V-Rod	1250		2007 → 2008	FDB2210	2		ST/P	FDB2210			ST/P
VRSCAW V-Rod (Spoke wheel)	1250		2008 →	FDB2210	2		ST/P	FDB2210			ST/P
VRSCDX Night Rod Special (Cast Wheel)	1250		2008 →	FDB2210	2		ST/P	FDB2210			ST/P
VRSCF V-Rod Muscle	1250		2008 →	FDB2210	2		ST/P	FDB2210			ST/P
VRSCX V-Rod	1250		2008 →	FDB2210	2		ST/P	FDB2210			ST/P
FL / FLH Electra Glide (4-speed)	1340		1972 →	FDB185			PRP/P				
FL / FLH Electra Glide (4-speed)	1340		1973 → 1980	FDB185			PRP/P	FDB185			PRP/P
FL / FLH Electra Glide (4-speed)	1340		1981 → 1984	FDB185			PRP/P				
FLHR Road King (all models)	1340		1994 → 1999	FDB352			ST/P	FDB485			P
FLHS Electra Glide Sport	1340		→ 1993	FDB352			ST/P	FDB485			P
FLHS Electra Glide Sport	1340		1977 →	FDB185			PRP/P	FDB185			PRP/P
FLHT Electra Glide (all models)	1340		1983 →	FDB334			P				
FLHT Electra Glide (all models)	1340		1984 → 1985	FDB352			ST/P				
FLHT Electra Glide (all models)	1340		1986 → 1999	FDB352			ST/P	FDB485			P
FLST Heritage Softail	1340		→	FDB352			ST/P	FDB335			PRP/P
FLST Heritage Softail	1340		→ 1990	FDB352			ST/P	FDB2001			SG/PRP/P
FLSTC Heritage Softail Classic	1340		1987 → 1999	FDB352			ST/P	FDB2001			SG/PRP/P
FLSTF Fat Boy	1340		1990 → 1999	FDB352			ST/P	FDB2001			SG/PRP/P
FLSTN Heritage Softail	1340		1993 → 1996	FDB352			ST/P	FDB2001			SG/PRP/P
FLSTS Heritage Springer Softail	1340		1997 → 1999	FDB352			ST/P	FDB2001			SG/PRP/P
FLT Tour Glide (all models)	1340		1980 → 1983	FDB334			P				
FLT Tour Glide (all models)	1340		1984 → 1985	FDB352			ST/P				
FLT Tour Glide (all models)	1340		1986 → 1999	FDB352			ST/P	FDB485			P
FLTR Road Glide (all models)	1340		1998 → 1999	FDB352			ST/P	FDB485			P
FX Super Glide	1340		1973 →	FDB185			PRP/P	FDB185			PRP/P
FX Super Glide	1340		1974 → 1977					FDB185			PRP/P
FX Super Glide	1340		1978 → 1981	FDB333			PRP/P	FDB185			PRP/P
FXB Sturgis Belt	1340		1977 → 1981	FDB333			PRP/P	FDB185			PRP/P
FXB Sturgis Belt	1340		1982 →	FDB333			PRP/P	FDB335			PRP/P
FXD Dyna Super Glide	1340		1995 → 1999	FDB352			ST/P	FDB2001			SG/PRP/P
FXDB Dyna Street Bob	1340		1991 → 1992	FDB352			ST/P	FDB2001			SG/PRP/P
FXDC Dyna Super Glide Custom	1340		1991 → 1992	FDB352			ST/P	FDB2001			SG/PRP/P
FXDG Dyna Glide Sturgis	1340		1991 →	FDB352			ST/P	FDB2001			SG/PRP/P
FXDL Low Rider	1340		1993 → 1999	FDB352			ST/P	FDB2001			SG/PRP/P
FXDS-Conv. / Dyna Convertible	1340		1994 → 1999	FDB352			ST/P	FDB2001			SG/PRP/P
FXDWG Wide Glide	1340		1993 → 1999	FDB352			ST/P	FDB2001			SG/PRP/P
FXDX Dyna Super Glide Sport	1340		1995 → 1999	FDB352			ST/P	FDB2001			SG/PRP/P
FXE Super Glide	1340		1973 →	FDB185			PRP/P	FDB185			PRP/P
FXE Super Glide	1340		1974 → 1977					FDB185			PRP/P
FXE Super Glide	1340		1978 → 1981	FDB333			PRP/P	FDB185			PRP/P
FXE Super Glide	1340		1982 → 1983	FDB333			PRP/P	FDB335			PRP/P
FXE Super Glide	1340		1984 → 1985	FDB352			ST/P	FDB335			PRP/P
FXEF Super Glide	1340		1978 → 1981	FDB333			PRP/P	FDB185			PRP/P
FXEF Super Glide	1340		1984 → 1985	FDB352			ST/P	FDB335			PRP/P
FXLR Low Rider Custom	1340		→ 1994	FDB352			ST/P	FDB2001			SG/PRP/P
FXLR Low Rider Custom	1340		→ 2000	FDB352			ST/P	FDB335			PRP/P
FXR Super Glide	1340		→ 1994	FDB352			ST/P	FDB2001			SG/PRP/P
FXRS Low Glide	1340		→ 1992	FDB352			ST/P	FDB2001			SG/PRP/P
FXRT Sport Glide	1340		→ 1992	FDB352			ST/P	FDB2001			SG/PRP/P
FXR Super Glide II	1340		1982 → 1983	FDB333			PRP/P	FDB335			PRP/P
FXRS Super Glide II	1340		1982 → 1983	FDB333			PRP/P	FDB335			PRP/P
FXRT Sport Glide	1340		1983 →	FDB333			PRP/P	FDB335			PRP/P
FXRS Low Glide	1340		1984 →	FDB352			ST/P	FDB335			PRP/P
FXRT Sport Glide	1340		1984 →	FDB352			ST/P	FDB335			PRP/P
FXR Super Glide	1340		1986 →	FDB352			ST/P	FDB335			PRP/P
FXRD Sport Glide Grand Touring	1340		1986 →	FDB352			ST/P	FDB335			PRP/P
FXS Sturgis	1340		1977 → 1981	FDB333			PRP/P	FDB185			PRP/P
FXS Sturgis	1340		1982 →	FDB333			PRP/P	FDB335			PRP/P
FXSB Low Rider	1340		1983 →	FDB333			PRP/P	FDB335			PRP/P
FXSB Low Rider	1340		1984 → 1985	FDB352			ST/P	FDB335			PRP/P
FXST Softail	1340		1984 → 1986	FDB352			ST/P	FDB335			PRP/P
FXST Softail Standard	1340		1999 →	FDB352			ST/P	FDB2001			SG/PRP/P
FXSTB Night Train	1340		1999 → 1999	FDB352			ST/P	FDB2001			SG/PRP/P
FXSTC Softail Custom	1340		→ 1999	FDB352			ST/P	FDB2001			SG/PRP/P
FXSTC Softail Custom	1340		1986 →	FDB352			ST/P	FDB335			PRP/P

* It is recommended that in those applications where sintered pads are supplied as Original Equipment, replacement pads should also be of sintered composition.

** To avoid brake imbalance sintered pads fitted in rear calipers should only be used in combination with front calipers containing sintered pads.



CC KW FROM -> TO N° SET L/R COMPOUND N° SET L/R COMPOUND

...HARLEY DAVIDSON

FXSTS Springer Softail	1340		→ 1999	FDB352			ST/P	FDB2001			SG/PRP/P
FXSTSB Bad Boy	1340	1995	→ 1997	FDB352			ST/P	FDB2001			SG/PRP/P
FXWG Wide Glide	1340	1980	→ 1981	FDB333			PRP/P	FDB185			PRP/P
FXWG Wide Glide	1340	1982	→ 1983	FDB333			PRP/P	FDB335			PRP/P
FXWG Wide Glide	1340	1984	→ 1986	FDB352			ST/P	FDB335			PRP/P
FLHR Road King	1450	2000	→ 2006	FDB2097	2		ST/PRP/P	FDB2097			ST/PRP/P
FLHRCI Road King Classic	1450	2000	→ 2006	FDB2097	2		ST/PRP/P	FDB2097			ST/PRP/P
FLHRI Road King	1450	2000	→ 2006	FDB2097	2		ST/PRP/P	FDB2097			ST/PRP/P
FLHRS/FLHRSi Road King Custom	1450	2004	→ 2006	FDB2097	2		ST/PRP/P	FDB2097			ST/PRP/P
FLHT/FLHTi Electra Glide Standard	1450	2000	→ 2006	FDB2097	2		ST/PRP/P	FDB2097			ST/PRP/P
FLHTC Electra Glide Classic	1450	2000	→ 2005	FDB2097	2		ST/PRP/P	FDB2097			ST/PRP/P
FLHTCi Electra Glide Classic	1450	2000	→ 2006	FDB2097	2		ST/PRP/P	FDB2097			ST/PRP/P
FLHTCU-I Ultra Classic Electra Glide	1450	2000	→ 2006	FDB2097	2		ST/PRP/P	FDB2097			ST/PRP/P
FLHX/FLHXi Street Glide	1450	2006	→ 2006	FDB2097	2		ST/PRP/P	FDB2097			ST/PRP/P
FLST/FLSTi Heritage Softail	1450	2006	→	FDB2097			ST/PRP/P	FDB2097			ST/PRP/P
FLSTC Heritage Softail Classic	1450	2000	→ 2006	FDB2097			ST/PRP/P	FDB2097			ST/PRP/P
FLSTCi Heritage Softail Classic	1450	2001	→ 2006	FDB2097			ST/PRP/P	FDB2097			ST/PRP/P
FLSTF Fat Boy	1450	2000	→ 2006	FDB2097			ST/PRP/P	FDB2097			ST/PRP/P
FLSTFi Fat Boy	1450	2001	→ 2006	FDB2097			ST/PRP/P	FDB2097			ST/PRP/P
FLSTFi Fat Boy 15th Anniversary Edition	1450	2005	→ 2005	FDB2097			ST/PRP/P	FDB2097			ST/PRP/P
FLSTN/FLSTNi Softail Deluxe	1450	2005	→ 2006	FDB2097			ST/PRP/P	FDB2097			ST/PRP/P
FLSTS/I Heritage Springer	1450	2000	→ 2003	FDB352			ST/P	FDB2097			ST/PRP/P
FLSTSC/FLSTSCi Springer Classic	1450	2005	→ 2007	FDB352			ST/P	FDB2097			ST/PRP/P
FLTR Road Glide	1450	2000	→ 2004	FDB2097	2		ST/PRP/P	FDB2097			ST/PRP/P
FLTR-i Road Glide	1450	2000	→ 2006	FDB2097	2		ST/PRP/P	FDB2097			ST/PRP/P
FXD Super Glide	1450	2000	→ 2003	FDB2097			ST/PRP/P	FDB2097			ST/PRP/P
FXDi Super Glide	1450	2004	→ 2005	FDB2097			ST/PRP/P	FDB2097			ST/PRP/P
FXDi 35 35th Anniv. Super Glide (Spoke wheels)	1450	2006	→ 2006	FDB2097			ST/PRP/P	FDB2097			ST/PRP/P
FXDi Super Glide (Cast wheel)	1450	2006	→ 2007	FDB2097			ST/PRP/P	FDB2097			ST/PRP/P
FXDBi Street Bob (Spoke wheel)	1450	2006	→ 2006	FDB2097			ST/PRP/P	FDB2097			ST/PRP/P
FXDC/I Dyna Super Glide Custom	1450	2005	→ 2006	FDB2097			ST/PRP/P	FDB2097			ST/PRP/P
FXDL Low Rider	1450	2000	→ 2003	FDB2097	2		ST/PRP/P	FDB2097			ST/PRP/P
FXDL Low Rider	1450	2004	→ 2005	FDB2097			ST/PRP/P	FDB2097			ST/PRP/P
FXDLi Low Rider	1450	2004	→ 2006	FDB2097			ST/PRP/P	FDB2097			ST/PRP/P
FXDS-Conv. / Dyna Convertible	1450	2000	→ 2002	FDB2097	2		ST/PRP/P	FDB2097			ST/PRP/P
FXDWG Wide Glide	1450	2000	→ 2003	FDB2097	2		ST/PRP/P	FDB2097			ST/PRP/P
FXDWG Wide Glide	1450	2004	→ 2005	FDB2097			ST/PRP/P	FDB2097			ST/PRP/P
FXDWGi Wide Glide	1450	2004	→ 2006	FDB2097			ST/PRP/P	FDB2097			ST/PRP/P
FXDX Super Glide Sport	1450	2000	→ 2003	FDB2097	2		ST/PRP/P	FDB2097			ST/PRP/P
FXDXT Super Glide T-Sport	1450	2000	→ 2003	FDB2097	2		ST/PRP/P	FDB2097			ST/PRP/P
FXDXi Super Glide Sport	1450	2004	→ 2005	FDB2097	2		ST/PRP/P	FDB2097			ST/PRP/P
FXST/FXSTi Softail Standard	1450	2000	→ 2005	FDB2097			ST/PRP/P	FDB2097			ST/PRP/P
FXSTB/FXSTBi Night Train	1450	2000	→ 2005	FDB2097			ST/PRP/P	FDB2097			ST/PRP/P
FXSTD/I Softail Deuce	1450	2000	→ 2005	FDB2097			ST/PRP/P	FDB2097			ST/PRP/P
FXSTD/I Softail Deuce	1450	2006	→	FDB2097			ST/PRP/P	FDB2202			ST/P
FXSTS/FXSTSi Softail Springer	1450	2000	→ 2005	FDB352			ST/P	FDB2097			ST/PRP/P
FXSTS/FXSTSi Softail Springer	1450	2006	→	FDB352			ST/P	FDB2202			ST/P
FLHR Road King	1584	2007	→ 2011	FDB2210	2		ST/P	FDB2210			ST/P
FLHRC Road King Classic	1584	2007	→ 2011	FDB2210	2		ST/P	FDB2210			ST/P
FLHRS Road King Custom	1584	2007	→ 2007	FDB2097	2		ST/PRP/P	FDB2097			ST/PRP/P
FLHR Road King Shrine	1584	2008	→ 2011	FDB2210	2		ST/P	FDB2210			ST/P
FLHT/FLHTi Electra Glide Standard	1584	2007	→ 2007	FDB2097	2		ST/PRP/P	FDB2097			ST/PRP/P
FLHT Electra Glide Standard	1584	2008	→ 2010	FDB2210	2		ST/P	FDB2210			ST/P
FLHTC Electra Glide Classic	1584	2007	→ 2007	FDB2097	2		ST/PRP/P	FDB2097			ST/PRP/P
FLHTCU Ultra Classic Electra Glide	1584	2007	→ 2007	FDB2097	2		ST/PRP/P	FDB2097			ST/PRP/P
FLHTC Electra Glide Classic	1584	2008	→ 2011	FDB2210	2		ST/P	FDB2210			ST/P
FLHTCU Ultra Classic Electra Glide	1584	2008	→ 2011	FDB2210	2		ST/P	FDB2210			ST/P
FLHTCU Ultra Classic Electra Glide Shrine	1584	2008	→ 2011	FDB2210	2		ST/P	FDB2210			ST/P
FLHX Street Glide	1584	2007	→ 2007	FDB2097	2		ST/PRP/P	FDB2097			ST/PRP/P
FLHX Street Glide	1584	2008	→ 2011	FDB2210	2		ST/P	FDB2210			ST/P
FLSTC Heritage Softail Classic	1584	2007	→ 2007	FDB2097			ST/PRP/P	FDB2202			ST/P
FLSTC Heritage Softail Classic	1584	2008	→ 2014	FDB2250			ST	FDB2251			ST
FLSTC Heritage Softail Classic	1584	2015	→ 2015	FDB2114			XRAC/ST/P	FDB2251			ST
FLSTF Fat Boy	1584	2007	→ 2007	FDB2097			ST/PRP/P	FDB2202			ST/P
FLSTF Fat Boy	1584	2008	→ 2014	FDB2250			ST	FDB2251			ST
FLSTFB Fat Boy Special/Lo	1584	2010	→ 2014	FDB2250			ST	FDB2251			ST
FLSTFB ANV Fat Boy Lo 110th Ann. Ed.	1584	2013	→ 2013	FDB2250			ST	FDB2251			ST
FLSTF Fat Boy	1584	2015	→	FDB2114			XRAC/ST/P	FDB2251			ST
FLSTFB Fat Boy Special/Lo	1584	2015	→	FDB2114			XRAC/ST/P	FDB2251			ST
FLSTN Softail Deluxe	1584	2007	→ 2014	FDB2250			ST	FDB2251			ST
FLSTN Softail Deluxe	1584	2015	→	FDB2114			XRAC/ST/P	FDB2251			ST
FLSTSC/FLSTSCi Springer Softail Classic	1584	2006	→ 2007	FDB352			ST/P	FDB2202			ST/P
FLSTSB Softail Cross Bones	1584	2008	→ 2011	FDB352			ST/P	FDB2251			ST
FLTR Road Glide	1584	2007	→ 2009	FDB2210	2		ST/P	FDB2210			ST/P

* It is recommended that in those applications where sintered pads are supplied as Original Equipment, replacement pads should also be of sintered composition.

** To avoid brake imbalance sintered pads fitted in rear calipers should only be used in combination with front calipers containing sintered pads.



CC KW FROM -> TO N° SET L/R COMPOUND N° SET L/R COMPOUND

...HARLEY DAVIDSON

FLTRX Road Glide Custom	1584	2010	→ 2011	FDB2210	2		ST/P	FDB2210		ST/P
FXCW Rocker (Cast wheel)	1584	2008	→ 2009	FDB2250			ST	FDB2251		ST
FXCWC Rocker C (Cast wheel)	1584	2008	→ 2011	FDB2250			ST	FDB2251		ST
FXD Super Glide (Cast wheel)	1584	2008	→ 2010	FDB2250			ST	FDB2251		ST
FXDB Street Bob (Spoke wheel)	1584	2007	→ 2007	FDB2097			ST/PRP/P	FDB2097		ST/PRP/P
FXDB Street Bob (Spoke wheel)	1584	2008	→ 2013	FDB2250			ST	FDB2251		ST
FXDC Dyna Super Glide Custom (Spoke wheels)	1584	2007	→ 2007	FDB2097			ST/PRP/P	FDB2097		ST/PRP/P
FXDC Dyna Super Glide Custom (Spoke wheels)	1584	2008	→ 2013	FDB2250			ST	FDB2251		ST
FXDF Fat Bob	1584	2008	→	FDB2250	2		ST	FDB2251		ST
FXDL Low Rider	1584	2007	→ 2007	FDB2097			ST/PRP/P	FDB2097		ST/PRP/P
FXDL Low Rider	1584	2008	→	FDB2250			ST	FDB2251		ST
FXDWG Wide Glide	1584	2007	→ 2007	FDB2097			ST/PRP/P	FDB2097		ST/PRP/P
FXDWG Wide Glide 105th Ann.	1584	2008	→ 2008	FDB2250			ST	FDB2251		ST
FXDWG Wide Glide	1584	2010	→	FDB2250			ST	FDB2251		ST
FXS Blackline	1584	2011	→ 2013	FDB2250			ST	FDB2251		ST
FXST/FXSTI Softail Standard	1584	2006	→ 2007	FDB2097			ST/PRP/P	FDB2202		ST/P
FXST Softail Standard	1584	2015	→	FDB2114			XRAC/ST/P	FDB2251		ST
FXSTB/FXSTBI Night Train Softail	1584	2006	→ 2007	FDB2097			ST/PRP/P	FDB2202		ST/P
FXSTB Night Train (Spoke wheel)	1584	2008	→ 2009	FDB2250			ST	FDB2251		ST
FXSTC Softail Custom	1584	2007	→	FDB2097			ST/PRP/P	FDB2202		ST/P
FXSTC Softail Custom (Spoke wheel)	1584	2008	→ 2010	FDB2250			ST	FDB2251		ST
FXSTD Softail Deuce	1584	2007	→	FDB2097			ST/PRP/P	FDB2202		ST/P
FXSTI Softail Standard	1584	2008	→ 2014	FDB2250			ST	FDB2251		ST
FLD Switchback	1690	2012	→	FDB2250			ST	FDB2251		ST
FLHR Road King	1690	2011	→	FDB2210	2		ST/P	FDB2210		ST/P
FLHRC Road King Classic	1690	2011	→	FDB2210	2		ST/P	FDB2210		ST/P
FLHR Road King Shrine	1690	2012	→ 2013	FDB2210	2		ST/P	FDB2210		ST/P
FLHR ANV Road King 110th Ann. Ed.	1690	2013	→ 2013	FDB2210	2		ST/P	FDB2210		ST/P
FLHR CVO Road King	1690	2014	→ 2014	FDB2210	2		ST/P	FDB2210		ST/P
FLHTCUTG Ultra Classic Tri Glide	1690	2009	→ 2014	FDB2210	2		ST/P			
FLHTC Electra Glide Classic	1690	2012	→ 2013	FDB2210	2		ST/P	FDB2210		ST/P
FLHTCU Ultra Classic Electra Glide	1690	2012	→	FDB2210	2		ST/P	FDB2210		ST/P
FLHTCU Ultra Classic Electra Glide Shrine	1690	2012	→ 2013	FDB2210	2		ST/P	FDB2210		ST/P
FLHTCUSE8 CVO Ultra Classic Electra Glide	1690	2013	→ 2013	FDB2210	2		ST/P	FDB2210		ST/P
FLHTCU TC Ultra Classic Electra Glide	1690	2014	→	FDB2210	2		ST/P	FDB2210		ST/P
FLHTCUL TC Ultra Classic Electra Glide Low	1690	2015	→	FDB2210	2		ST/P	FDB2210		ST/P
FLHTCUL Ultra Classic Electra Glide Low	1690	2015	→	FDB2210	2		ST/P	FDB2210		ST/P
FLHTK Electra Glide Ultra LTD	1690	2010	→	FDB2210	2		ST/P	FDB2210		ST/P
FLHTK ANV Electra Glide Ultra LTD 110th Ann. Ed.	1690	2013	→ 2013	FDB2210	2		ST/P	FDB2210		ST/P
FLHTK CVO Electra Glide Ultra LTD	1690	2014	→ 2014	FDB2210	2		ST/P	FDB2210		ST/P
FLHTK Electra Glide Ultra LTD Shrine	1690	2015	→ 2016	FDB2210	2		ST/P	FDB2210		ST/P
FLHTKL Electra Glide Ultra LTD Low	1690	2015	→	FDB2210	2		ST/P	FDB2210		ST/P
FLHXXX Street Glide Trike	1690	2010	→ 2011	FDB2210	2		ST/P			
FLHX Street Glide	1690	2011	→	FDB2210	2		ST/P	FDB2210		ST/P
FLHXS Street Glide Special	1690	2014	→	FDB2210	2		ST/P	FDB2210		ST/P
FLS Softail Slim	1690	2012	→ 2014	FDB2250			ST	FDB2251		ST
FLS Softail Slim	1690	2015	→	FDB2114			XRAC/ST/P	FDB2251		ST
FLSTC Heritage Softail Classic	1690	2012	→ 2014	FDB2250			ST	FDB2251		ST
FLSTC Heritage Softail Classic	1690	2015	→	FDB2114			XRAC/ST/P	FDB2251		ST
FLSTFSE2 Fat Boy	1690	2006	→ 2006	FDB2097			ST/PRP/P	FDB2097		ST/PRP/P
FLSTF Fat Boy	1690	2012	→ 2014	FDB2250			ST	FDB2251		ST
FLSTFB Fat Boy Special/Lo	1690	2012	→ 2014	FDB2250			ST	FDB2251		ST
FLSTF Fat Boy	1690	2015	→	FDB2114			XRAC/ST/P	FDB2251		ST
FLSTFB Fat Boy Special/Lo	1690	2015	→	FDB2114			XRAC/ST/P	FDB2251		ST
FLSTN Softail Deluxe	1690	2012	→ 2014	FDB2250			ST	FDB2251		ST
FLSTN Softail Deluxe	1690	2015	→	FDB2114			XRAC/ST/P	FDB2251		ST
FLTRU Road Glide Ultra	1690	2011	→ 2013	FDB2210	2		ST/P	FDB2210		ST/P
FLTRX Road Glide Custom	1690	2011	→	FDB2210	2		ST/P	FDB2210		ST/P
FLTRXS Road Glide Special	1690	2015	→	FDB2210	2		ST/P	FDB2210		ST/P
FLTRU Road Glide Ultra	1690	2016	→	FDB2210	2		ST/P	FDB2210		ST/P
FXDB Street Bob (Spoke wheel)	1690	2014	→	FDB2250			ST	FDB2251		ST
FXDB Street Bob Special	1690	2016	→	FDB2250			ST	FDB2251		ST
FXDC Dyna Super Glide Custom (Spoke wheel)	1690	2014	→	FDB2250			ST	FDB2251		ST
FXDF Fat Bob	1690	2012	→	FDB2250	2		ST	FDB2251		ST
FXDL Low Rider	1690	2014	→	FDB2250	2		ST	FDB2251		ST
FXDWG Wide Glide	1690	2012	→	FDB2250			ST	FDB2251		ST
FXSB Breakout	1690	2013	→ 2014	FDB2250			ST	FDB2251		ST
FXSB Breakout	1690	2015	→	FDB2114			XRAC/ST/P	FDB2251		ST
FLDE Deluxe	1745	2018	→	FDB2114			XRAC/ST/P	FDB2306		ST/P
FLFB Fat Boy	1745	2018	→	FDB2114			XRAC/ST/P	FDB2306		ST/P
FLHC Heritage Classic	1745	2018	→	FDB2114			XRAC/ST/P	FDB2306		ST/P
FLHR Road King	1745	2018	→	FDB2210	2		ST/P	FDB2210		ST/P
FLHRC Road King Classic	1745	2018	→	FDB2210	2		ST/P	FDB2210		ST/P
FLHRXS Road King Special	1745	2018	→	FDB2210	2		ST/P	FDB2219		ZR/SG

* It is recommended that in those applications where sintered pads are supplied as Original Equipment, replacement pads should also be of sintered composition.

** To avoid brake imbalance sintered pads fitted in rear calipers should only be used in combination with front calipers containing sintered pads.

1030



CC KW FROM -> TO N° SET L/R COMPOUND N° SET L/R COMPOUND

...HARLEY DAVIDSON

FLHTK Electra Glide Ultra LTD	1745	2018	→	FDB2210	2		ST/P	FDB2210		ST/P
FLHTKL Electra Glide Ultra LTD Low	1745	2018	→	FDB2210	2		ST/P	FDB2210		ST/P
FLHX Street Glide	1745	2018	→	FDB2210	2		ST/P	FDB2210		ST/P
FLHXS Street Glide Special	1745	2018	→	FDB2210	2		ST/P	FDB2210		ST/P
FLS Softail Slim	1745	2018	→	FDB2114			XRAC/ST/P	FDB2251		ST
FLSL Softail Slim	1745	2018	→	FDB2114			XRAC/ST/P	FDB2306		ST/P
FLSL Softail Deluxe	1745	2018	→	FDB2114			XRAC/ST/P			
FLSTC Heritage Softail Classic	1745	2018	→	FDB2114			XRAC/ST/P	FDB2251		ST
FLSTF Fat Boy	1745	2018	→	FDB2114			XRAC/ST/P	FDB2251		ST
FLTRU Road Glide Ultra	1745	2018	→	FDB2210	2		ST/P	FDB2210		ST/P
FLTRX Road Glide Custom	1745	2018	→	FDB2210	2		ST/P	FDB2210		ST/P
FLTRXS Road Glide Special	1745	2018	→	FDB2210	2		ST/P	FDB2210		ST/P
FXBB Street Bob	1745	2018	→	FDB2114			XRAC/ST/P	FDB2306		ST/P
FXBR Breakout	1745	2018	→	FDB2114			XRAC/ST/P	FDB2306		ST/P
FXBS Fat Bob	1745	2018	→	FDB2114	2		XRAC/ST/P	FDB2306		ST/P
FXDF Fat Bob	1745	2018	→	FDB2250	2		ST	FDB2251		ST
FXFB Fat Bob	1745	2018	→	FDB2114	2		XRAC/ST/P	FDB2306		ST/P
FXLR Low Rider	1745	2018	→	FDB2114	2		XRAC/ST/P	FDB2306		ST/P
FXSB Breakout	1745	2018	→	FDB2114			XRAC/ST/P	FDB2251		ST
FLSB Sport Glide	1745	2018	→	FDB2114			XRAC/ST/P	FDB2306		ST/P
FLHTCUTG Tri Glide Ultra Classic	1745	2014	→	FDB2210	2		ST/P			
FLHRSE CVO Road King	1802	2014	→ 2014	FDB2210	2		ST/P	FDB2210		ST/P
FLHTCUSE4-5-6-7 CVO Ultra Classic Electra Glide	1802	2009	→ 2012	FDB2210	2		ST/P	FDB2210		ST/P
FLHTCU8 CVO Ultra Classic Electra Glide	1802	2013	→ 2013	FDB2210	2		ST/P	FDB2210		ST/P
FLHTKSE CVO Electra Glide Ultra LTD	1802	2014	→	FDB2210	2		ST/P	FDB2210		ST/P
FLHXSE-SE2-SE3 CVO Street Glide	1802	2010	→ 2012	FDB2210	2		ST/P	FDB2210		ST/P
FLS Softail Slim S	1802	2016	→	FDB2114			XRAC/ST/P	FDB2251		ST
FLSTC Heritage Softail Classic	1802	2016	→	FDB2114			XRAC/ST/P	FDB2251		ST
FLSTF Fat Boy S	1802	2016	→	FDB2114			XRAC/ST/P	FDB2251		ST
FLTRSE3 CVO Road Glide	1802	2009	→ 2009	FDB2210	2		ST/P	FDB2210		ST/P
FLTRUSE CVO Road Glide Ultra	1802	2011	→ 2011	FDB2210	2		ST/P	FDB2210		ST/P
FLTRUSE CVO Road Glide Ultra	1802	2015	→ 2015	FDB2210	2		ST/P	FDB2210		ST/P
FLFBS Fat Boy 114	1868	2018	→	FDB2114			XRAC/ST/P	FDB2306		ST/P
FLHCS Heritage Classic 114	1868	2018	→	FDB2114			XRAC/ST/P	FDB2306		ST/P
FLHTK Ultra Limited	1868	2019	→	FDB2210	2		ST/P	FDB2210		ST/P
FLHTKL Ultra Limited	1868	2019	→	FDB2210	2		ST/P	FDB2210		ST/P
FLHXS Street Glide Special	1868	2019	→	FDB2210	2		ST/P	FDB2210		ST/P
FLSTC Heritage Softail Classic 114	1868	2018	→	FDB2114			XRAC/ST/P			
FLTRU Road Glide Ultra	1868	2019	→	FDB2210	2		ST/P	FDB2210		ST/P
FLTRXS Road Glide Special	1868	2019	→	FDB2210	2		ST/P	FDB2210		ST/P
FXBRS Breakout 114	1868	2018	→	FDB2114			XRAC/ST/P	FDB2306		ST/P
FXDR 114	1868	2020	→	FDB2114	2		XRAC/ST/P	FDB2306		ST/P
FXDRS 114	1868	2019	→	FDB2114	2		XRAC/ST/P	FDB2306		ST/P
FXFBS Fat Bob	1868	2018	→	FDB2114	2		XRAC/ST/P	FDB2306		ST/P
FXSB Breakout 114	1868	2018	→	FDB2114			XRAC/ST/P			
FLTRXSE CVO Road Glide	1923	2018	→	FDB2210	2		ST/P	FDB2210		ST/P
FLHTKSE CVO Limited	1923	2018	→	FDB2210	2		ST/P	FDB2210		ST/P
FLHXSE-SE2-SE3 CVO Street Glide	1923	2018	→	FDB2210	2		ST/P	FDB2210		ST/P

HERCULES (SACHS)

CHOPPER 50	50		→	FDB213	2		P			
GIPSY 50	50	1993	→	FDB680			ST/EF	FSB704		
LIMBO 50	50	1993	→	FSB703				FSB704		
RX - 9 / RX - 9 50 AIRCOOLED	50		→	FDB213			P			
SAMBA SR 50	50	1993	→	FSB704				FSB704		
SUPRA 50 4 GP	50		→	FDB213			P			
ULTRA 50 RS	50		→	FDB213			P			
ULTRA 50 RS 40	50		→	FDB213			P			
Lotus 80 SA	80		→	FDB213			P			
Lotus 80 SW	80		→	FDB207			ST/P/EF/CP1			
SAMBA SR 80	80	1993	→	FDB672			EF	FSB704		
ULTRA 80 RS	80		→	FDB213			P			
ULTRA 80 RS AC	80		→	FDB213	2		P			
SAMBA SR 125	125	1993	→	FDB672			EF	FSB704		
ULTRA 125 RS	125		→	FDB213			P			

HERO

HF Dawn	97	6	2013	→	FSB705			FSB705		
HF Deluxe	97	6	2013	→	FSB705			FSB705		
HF Dawn	97	6	2016	→	FSB705			FSB705		

* It is recommended that in those applications where sintered pads are supplied as Original Equipment, replacement pads should also be of sintered composition.

** To avoid brake imbalance sintered pads fitted in rear calipers should only be used in combination with front calipers containing sintered pads.



CC KW FROM -> TO N° SET L/R COMPOUND N° SET L/R COMPOUND

...HERO

HF Deluxe Eco	97	6	2016	→	FSB705				FSB705			
Passion Pro	97	6	2008	→	FSB705				FSB705			
Passion Pro TR	97	6	2014	→	FDB2287			EF	FSB970			
Passion Pro	97	6	2016	→	FDB2287			EF	FSB970			
Splendor Plus	97	6	2003	→	FSB958				FSB705			
Splendor Pro	97	6	2005	→	FSB958				FSB705			
Splendor NXG	97	6	2007	→	FSB958				FSB705			
Splendor iSmart	97	6	2014	→	FSB705				FSB705			
Splendor Pro Classic	97	6	2014	→	FSB705				FSB705			
Splendor	97	6	2016	→	FSB705				FSB705			
Splendor iSmart	97	6	2016	→	FSB705				FSB705			
Splendor Pro	97	6	2016	→	FSB705				FSB705			
Splendor Pro Classic	97	6	2016	→	FSB705				FSB705			
CD 100	100		1985	→ 1991	FSB705				FSB705			
Dawn	100		2003	→	FSB705				FSB705			
Passion	100		2001	→	FSB705				FSB705			
Splendor	100		1994	→ 2008	FSB958				FSB705			
Splendor	100		2008	→	FSB705				FSB705			
Pleasure	102	5	2005	→	FSB958				FSB705			
Pleasure	102	5	2014	→	FSB958				FSB705			
Pleasure	102	5	2016	→	FSB958				FSB705			
iSmart 110	109	7	2016	→	FSB958				FSB705			
Maestro	109	6	2012	→	FSB970				FSB970			
Maestro	109	6	2016	→	FDB2087			EF	FDB2143			P/EF
Passion XPro	109	7	2012	→	FDB2287			EF	FSB970			
Passion XPro	109	6	2016	→	FDB2287			EF	FSB970			
Splendor iSmart 110	109	7	2016	→	FSB705				FSB705			
Maestro Edge	110	6	2016	→	FSB970				FSB970			
Passion Plus	110		2012	→	FDB2287			EF	FSB963			
Splendor Super	124	7	2005	→	FSB958				FSB705			
Splendor Super	124	7	2014	→	FSB705				FSB705			
Splendor Super	124	7	2016	→	FSB705				FSB705			
SUPER SPLENDOR	125			→					FSB970			
Hunk	149	10	2013	→ 2015	FSB970				FSB970			
Hunk	149	12	2016	→	FSB970				FSB970			
CBZ	150		1999	→ 2006	FDB2087			EF	FSB963			
Karizma	220		2003	→	FDB2087			EF	FSB963			
Karizma ZMR	220		2003	→	FDB2087			EF	FDB2143			P/EF
Karizma R	223	12	2003	→	FDB2087			EF	FSB970			
Karizma ZMR	223	13	2009	→	FDB2087			EF	FDB2143			P/EF
Karizma R	223	15	2014	→	FDB2087			EF	FSB970			
Karizma ZMR	223	15	2014	→	FDB2087			EF	FDB2143			P/EF
Karizma	223	14	2016	→	FDB2087			EF	FSB970			
Karizma ZMR	223	15	2016	→	FDB2087			EF	FDB2143			P/EF
Karizma ZMR 230	320		2011	→ 2012	FDB2169			P/EF	FDB2143			P/EF

HONDA

BENLY	50		2012	→ 2017	FSB963				FSB963			
BENLY PRO	50		2012	→ 2017	FSB963				FSB963			
C 50 ZZ ZZ ZA	50		1975	→ 1993	FSB704				FSB704			
CAMINO 50 all models	50		1980	→	FSB712				FSB712			
CB 50 J all models	50		1981	→	FSB704				FSB704			
CF 50 CHALY	50		1979	→	FSB704				FSB704			
CR 50 R	50		1984	→ 1985	FSB714				FSB714			
CR 50 R	50		1986	→	FDB382			SG/P				
CRF 50 F	50		2004	→	FSB702				FSB702			
CRM 50	50		1988	→ 1992	FDB250			SG/P/EF	FSB756			
CRM 50	50		1993	→ 1996	FDB250			SG/P/EF	FDB539			SG/P/EF
DAX 50	50		1993	→ 1996	FSB704				FSB704			
G-DASH 50	50		1989	→ 1992	FDB250			SG/P/EF	FSB714			
GP 50 DIO	50		1991	→ 1995	FDB625			EF	FSB714			
GYRO Canopy	50		2008	→ 2017	FSB963				FSB963			
GYRO X	50		2008	→ 2017	FSB963				FSB963			
LIFE DIO 50	50		1994	→	FSB714				FSB714			
MB 50	50		1982	→	FDB250			SG/P/EF	FSB705			
MBX 50 SD - SF	50		1983	→	FDB312			ST/P/EF	FSB705			
MONKEY 50	50		1988	→					FSB704			
MT 50	50		1980	→	FSB705				FSB705			
MTX 50 S	50		1983	→	FSB705				FSB705			
MXR 50	50			→	FDB250			SG/P/EF	FSB705			
NB 50 DELUX	50		1982	→	FSB702				FSB703			
NB 50 MELODY	50		1982	→	FSB702				FSB703			

* It is recommended that in those applications where sintered pads are supplied as Original Equipment, replacement pads should also be of sintered composition.

** To avoid brake imbalance sintered pads fitted in rear calipers should only be used in combination with front calipers containing sintered pads.



...HONDA

	CC	KW	FROM -> TO		N° SET	L/R	COMPOUND		N° SET	L/R	COMPOUND
NB 50 MSB	50		1982 →	FSB702				FSB703			
NB 50	50		1985 →	FSB702				FSB703			
NC 50 KI	50		1979 →	FSB702				FSB702			
NC 50 Z EXPRESS	50		1979 →	FSB702				FSB702			
NC 50 A	50		1982 →	FSB702				FSB702			
NC 50 B	50		1982 →	FSB702				FSB702			
NC 50 C	50		1982 →	FSB702				FSB702			
NC 50 EXPRESS 2	50		1982 →	FSB702				FSB702			
NC 50 EXPRESS 3	50		1982 →	FSB702				FSB702			
ND 50	50		1982 →	FSB702				FSB703			
ND 50 MELODY 2 all models	50		1982 →	FSB702				FSB703			
NE 50 VISION	50		1985 →	FSB702				FSB703			
NH 50 LEAD	50		→ 1987	FSB704				FSB703			
NH 50 LEAD	50		1988 → 1992	FDB2192			AG	FSB703			
NH 50 LEAD	50		1993 → 1994	FSB704				FSB703			
NH 50 LEAD	50		1994 →	FDB672			EF	FSB703			
NP 50 D MELODY MINI	50		1983 →	FSB702				FSB703			
NSC 50 C,AC Vision & R	50		2012 →	FDB2256			EF	FSB963			
NSR 50 (Spain)	50		→	FDB312			ST/P/EF	FDB539			SG/P/EF
NSR 50	50		1993 → 1994	FDB312			ST/P/EF	FSB705			
NSR 50	50		1994 → 2000	FDB631			ST/SM/SG/P/EF/AG	FSB705			
NU 50 M RUNAWAY	50		1982 → 1983	FSB714				FSB703			
NV 50 MSD STREAM	50		1984 →	FSB703				FSB703			
NX 50	50		1981 → 1982	FSB702				FSB703			
OR 50	50		1993 →	FSB702				FSB703			
PA 50 all models	50		1980 →	FSB712				FSB712			
PC 50 KI	50		1979 →	FSB702				FSB702			
PF 50 M	50		1975 →	FSB712				FSB712			
PK 50 WALLAROO DX - STD	50		1990 → 2001	FSB714				FSB704			
PRESS CUB 50 DELUXE	50		2000 → 2008					FSB963			
PRESS CUB 50 STANDARD	50		2000 → 2008					FSB963			
PX 50 all models	50		1982 → 1983	FSB712				FSB703			
PX 50 E	50		1984 →	FSB712							
PXR 50 ALL MODELS	50		1985 → 1995	FSB758				FSB754			
QA 50 K1/3	50		1987 → 1990	FSB704				FSB704			
QR 50 ED	50		1982 → 1990	FSB702				FSB703			
QR 50	50		1993 →	FSB702				FSB714			
SA 50 ELITE LX	50		1988 → 1990	FSB702				FSB703			
SA 50 J VISION MET-IN	50		1988 → 1990	FSB714				FSB714			
SAA 50 VISION	50		1993 →	FSB714				FSB714			
SFX 50	50		1995 →	FDB680			ST/EF	FSB704			
SH 50 CITY EXPRESS	50		1984 → 1996	FSB704				FSB715			
SH 50 SCOOPY	50		1988 → 1994	FSB715				FSB715			
SH 50 SCOOPY / FIFTY	50		1997 → 2003	FDB680			ST/EF	FSB704			
SJ 50 BALI	50		1993 → 1999	FDB2060			P/AG	FSB704			
SKY 50	50		1997 →	FDB680			ST/EF	FSB704			
SKY 50 VETRO	50		2000 →	FDB680			ST/EF	FSB704			
SR 50 DIO	50		1990 →	FDB625			EF	FSB714			
SR 50 LIFE DIO	50		1994 →	FDB625			EF	FSB714			
SS 50 ZK2	50		1975 → 1977	FSB704				FSB704			
SS 50 ZB2	50		1977 → 1980					FSB704			
ST 50	50		1978 → 1993	FSB704				FSB704			
ST 50 DAX	50		1993 → 1996	FSB704				FSB704			
SUPER DIO 50 SR	50		1991 → 1992	FDB625			EF	FSB714			
SUPER DIO 50 ZX	50		1992 →	FDB625			EF	FSB714			
SXR 50	50		1997 → 1999	FDB680			ST/EF				
TLM 50 F	50		1985 →	FSB714				FSB714			
VT 50 SHADOW	50		1998 →					FSB704			
WW50	50		1995 →	FSB705				FSB958			
WW50DS	50		1995 →	FSB705				FSB958			
WW50NS	50		1995 →	FSB705				FSB958			
WW50S	50		1995 →	FSB705				FSB958			
X8R 50 S	50		1998 →	FDB680			ST/EF	FDB2101			AG
X8R 50 X	50		1998 →	FDB680			ST/EF	FDB2101			AG
XL 50	50		1977 → 1988	FSB705				FSB705			
XR 50 DIO BAJA	50		1994 →	FDB625			EF	FSB714			
XR 50 R	50		2000 →	FSB702				FSB702			
YUPY 50	50		1992 →	FDB625			EF				
Z 50 all models	50		1979 → 1991	FSB702				FSB702			
ZX 50 LIFE DIO	50		1994 →	FDB625			EF	FSB714			
ZX DIO 50	50		1995 →	FDB625			EF	FSB714			
CR 60 R	60		1986 →	FSB714				FSB714			
C 70 all models	70		1975 →	FSB704				FSB704			
CF 70 C	70		1978 → 1979	FSB704				FSB704			

HONDA

* It is recommended that in those applications where sintered pads are supplied as Original Equipment, replacement pads should also be of sintered composition.

** To avoid brake imbalance sintered pads fitted in rear calipers should only be used in combination with front calipers containing sintered pads.



CC KW FROM -> TO N° SET L/R COMPOUND N° SET L/R COMPOUND

...HONDA

CF 70 K2	70	1978	→ 1980	FSB704				FSB704			
CRF 70 F	70	2004	→	FSB714				FSB714			
DAX ST 70	70	1978	→ 1980	FSB704				FSB704			
SUPER CUB 70	70	1999	→ 2008	FSB963							
XR 70 RV	70	1997	→ 2003	FSB714				FSB714			
CRM 75	75	1990	→ 1994	FDB495			SG/P	FDB539			SG/P/EF
CRM 75 R	75	1990	→ 1994	FDB495			SG/P	FDB539			SG/P/EF
NF 75	75	1979	→	FSB704				FSB704			
NSR 75 (FII)	75	1988	→	FDB312			ST/P/EF	FSB705			
NSR 75 (NS-1)	75	1992	→ 2000	FDB2087			EF	FDB783			AG
SA 75 VISION	75	1988	→	FSB704				FSB714			
SH 75 SCOOPY	75	1988	→ 1995	FSB704				FSB715			
XR 75 K4	75	1975	→ 1979	FSB705				FSB705			
XR 75 K5	75	1979	→	FSB704				FSB705			
YUPY 75	75	1991	→	FDB539			SG/P/EF	FSB704			
CH 80 ELITE/SPACY	80	1985	→ 1990	FSB704				FSB714			
CR 80 RA - RB	80	1980	→ 1981	FSB705				FSB705			
CR 80 RC	80	1982	→ 1982	FSB705				FSB714			
CR 80 RD - RE - RF	80	1983	→ 1985	FSB714				FSB714			
CR 80 R2F/R2G	80	1985	→ 1986	FSB705				FSB756			
CR 80 R	80	1986	→ 1991	FDB661			SG/P	FSB756			
CR 80 R	80	1992	→ 1995	FDB661			SG/P	FDB539			SG/P/EF
CR 80 R/RB	80	1996	→ 2002	FDB661			SG/P	FDB539			SG/P/EF
CRM 80	80	1988	→ 1992	FDB250			SG/P/EF	FSB756			
CRM 80	80	1993	→	FDB250			SG/P/EF	FDB539			SG/P/EF
MB 80	80	1980	→	FDB313			SG/P/EF	FSB756			
MBX 80	80	1982	→	FDB312			ST/P/EF	FSB705			
MBX 80 DX	80	1982	→	FDB312			ST/P/EF	FSB705			
MBX 80 FWD	80	1983	→	FDB250	2		SG/P/EF	FSB705			
MBX 80 (ESPANA)	80	1984	→	FDB312			ST/P/EF	FSB704			
MBX 80 VOLLUERKLEIDUNG	80	1985	→	FDB312			ST/P/EF	FSB705			
MCX 80 all models	80	1982	→ 1984	FDB313			SG/P/EF	FSB705			
MT 80 all models	80	1980	→ 1984	FSB705				FSB705			
MTX 80 all models	80	1982	→ 1984	FSB705				FSB705			
NH 80 LEAD	80	1983	→ 1987	FSB704				FSB703			
NH 80 LEAD AERO	80	1983	→ 1985	FSB704				FSB703			
NH 80 LEAD	80	1988	→	FDB2192			AG	FSB703			
NSR 80 R	80	1987	→ 1992	FDB312			ST/P/EF	FDB539			SG/P/EF
NSR 80 R	80	1993	→ 1998	FDB631			ST/SM/SG/P/EF/AG	FDB539			SG/P/EF
SH 80 SCOOPY	80	1984	→	FSB704				FSB715			
XR 80 A - B - Z	80	1980	→ 1984	FSB705				FSB705			
XR 80 R	80	1985	→	FSB714				FSB714			
XR 80 RJ	80	1989	→	FSB705				FSB705			
CR 85 R/RB	85	2003	→ 2007	FDB381			SG/P/EF	FDB539			SG/P/EF
C 90	90	1975	→ 1981	FSB704				FSB704			
C 90	90	1982	→ 2003	FSB705				FSB705			
EZ 90 CUB	90	1990	→	FSB704				FSB704			
SUPER CUB 90	90	1999	→ 2008	FSB963							
VT 90 SHADOW	90	1998	→					FSB704			
YUPY 90 (NH 90)	90	1990	→	FDB672			EF	FSB705			
CB 100 N	100	1978	→	FDB485			P	FSB705			
CRF 100 F	100	2004	→	FSB714				FSB714			
H 100	100	1984	→ 1992	FSB704				FSB704			
NH 100 LEAD	100	2000	→	FDB2119			SM/SG/P/EF/AG	FSB963			
SCV 100 Lead	100	2002	→ 2006					FSB963			
SH 100 Scoopy	100	1996	→ 2001	FDB680			ST/EF	FSB704			
SJ 100 BALI - EX	100	1998	→ 1999	FDB2060			P/AG	FSB704			
SPACY 100	100	2002	→ 2007					FSB963			
SUPRA 100	100		→ 1998	FSB704				FSB704			
SUPRA 100	100	1999	→	FDB631			ST/SM/SG/P/EF/AG	FSB704			
XL 100 all models	100	1978	→	FSB705				FSB705			
XR 100 R	100	1985	→ 2003	FSB714				FSB714			
Activa	110		→					FSB963			
AFS 110 Wave (2SHC)	110	2012	→	FDB2282			EF				
Aviator	110	2009	→	FDB2169			P/EF	FSB963			
BENLY 110	110	2012	→	FSB963				FSB963			
BENLY 110 PRO	110	2012	→	FSB963				FSB963			
C110	110	2018	→					FSB963			
CRF 110 F	110	2013	→ 2018	FSB714				FSB714			
CT 110	110	1980	→ 1988	FSB704				FSB705			
CT 110	110	1989	→ 2004	FSB705				FSB705			
CT 110	110	2005	→ 2009	FSB705				FSB963			
NHX Elite	110	2010	→ 2011					FSB963			
NFC Moove	110	2014	→					FSB963			

* It is recommended that in those applications where sintered pads are supplied as Original Equipment, replacement pads should also be of sintered composition.

** To avoid brake imbalance sintered pads fitted in rear calipers should only be used in combination with front calipers containing sintered pads.



CC KW FROM -> TO N° SET L/R COMPOUND N° SET L/R COMPOUND

...HONDA

NSC 110 WHB,AC Vision	110	2011	→	FDB2256			EF	FSB963		
Scoopy 110i	110	2012	→					FSB963		
SCR 110	110	2013	→					FSB963		
SCV 110 Lead (WHA)	110	2010	→ 2011	FDB2256			EF	FSB963		
SUPER CUB 110	110	2009	→ 2012					FSB963		
Taranis 110 GP	110	2012	→					FSB963		
VISION	110	2017	→ 2018	FDB2289			EF			
Zoomer X	110	2013	→	FDB2289			EF	FSB963		
RAVI	115	2017	→	FSB963				FSB963		
Activa	125		→					FSB963		
AROBASE 125	125	2000	→ 2006					FSB963		
CA 125 REBEL	125	1995	→ 1997	FDB497			ST/SM/SG/P/EF	FSB709		
CA 125 REBEL	125	1998	→	FDB2060			P/AG	FSB709		
CB 125 K1 - K5	125	1972	→ 1976					FSB706		
CB 125 K6 - S2	125	1976	→ 1977					FSB706		
CB 125 T	125	1978	→	FDB485			P	FSB706		
CB 125 J	125	1979	→	FDB485			P	FSB705		
CB 125 T2 - TA - TB	125	1979	→	FDB485			P	FSB706		
CB 125 RS	125	1983	→	FDB250			SG/P/EF	FSB706		
CB 125 TDC - TDE - TDJ	125	1983	→ 1989	FDB244			ST/P/EF	FSB706		
CB 125 TT	125	1990	→	FDB663			ST/P/EF	FSB706		
CB Shine	125	2010	→	FDB2169			P/EF	FSB963		
CB 125 F	125	7	2015 → 2016	FDB631			ST/SM/SG/P/EF/AG	FSB963		
CB 125 F (GLR) 1WHH	125	2017	→	FDB2313			EF			
CB 125 R	125	10	2018 →	FDB2294			ST	FDB2275		P/EF
CBF 125 M	125	2009	→	FDB2169			P/EF	FSB963		
CBR 125 M	125	2009	→ 2017					FSB963		
CBR 125 R	125	2004	→ 2010	FDB2169			P/EF	FDB2143		P/EF
CBR 125 R	125	2011	→ 2016	FDB2169			P/EF	FDB2275		P/EF
CD 125 TC	125	1982	→	FSB707				FSB706		
CG 125	125	1977	→ 1984	FSB704				FSB704		
CG 125	125	1985	→	FSB958				FSB704		
CG 125	125	2007	→ 2008					FSB963		
CG 125 CARGO SINGLE SEAT	125	2002	→ 2003					FSB963		
CG 125 TITAN	125	2002	→ 2005					FSB963		
CG 125 WH	125	2016	→ 2017	FSB963						
CH 125 ELITE/SPACY	125	1983	→ 1997	FSB704				FSB704		
CHA 125 SPACY	125	1995	→ 2003	FDB2119			SM/SG/P/EF/AG	FSB958		
CH 125 ELITE/SPACY	125	1998	→	FDB312			ST/P/EF	FSB704		
Click 125i	125	2012	→ 2017	FDB2289			EF	FSB963		
CLR 125 CITY FLY	125	1998	→ 2003	FDB438			P/EF	FSB705		
CM 125 L	125	1982	→	FSB707				FSB706		
CR 125 M2 - 3 - 4	125	1976	→ 1978	FSB705				FSB705		
CR 125 RA	125	1979	→ 1981	FSB747				FSB958		
CR 125 RB	125	1979	→ 1981	FSB747				FSB958		
CR 125 RS	125	1979	→ 1981	FSB747				FSB958		
CR 125 RZ	125	1979	→ 1981	FSB747				FSB958		
CR 125 RC	125	1982	→ 1983	FSB745				FSB745		
CR 125 RD	125	1983	→ 1984	FSB745				FSB746		
CR 125 RE	125	1984	→ 1985	FDB382			SG/P	FSB746		
CR 125 RG	125	1986	→ 1986	FDB382			SG/P	FSB757		
CR 125 RH - J - K - L	125	1987	→ 1994	FDB495			SG/P	FDB539		SG/P/EF
CR 125 RW - RX - RY - R1	125	1996	→ 2001	FDB892			ZR/SG/P/EF/CPRO	FDB539		SG/P/EF
CR 125 R	125	2002	→ 2007	FDB892			ZR/SG/P/EF/CPRO	FDB2139		SG/P/EF
CRF 125 F (Small wheel 17"-14")	125	2014	→ 2016	FDB892			ZR/SG/P/EF/CPRO	FSB714		
CRF 125 FB (Big wheel 19"-16")	125	2014	→ 2018	FDB892			ZR/SG/P/EF/CPRO	FSB714		
CRM 125	125	1990	→ 1999	FDB495			SG/P	FDB539		SG/P/EF
CRM 125 (Italy)	125	1990	→ 1999	FDB438			P/EF	FRP416		P
CT 125	125	1976	→ 1978	FSB705				FSB705		
DIO 125	125	2010	→					FSB963		
125 DYLAN	125	2002	→	FDB2119			SM/SG/P/EF/AG	FSB963		
FES 125 PANTHEON	125	1998	→ 1999	FDB2073			ST/SM/P/EF	FSB946		
FES 125 PANTHEON	125	2000	→ 2006	FDB2075			ST/SM/P/EF	FSB946		
FES 125 S-WING	125	2007	→	FDB2196			ST/SM/P/EF	FDB2212		ST/SM/EF
NSS 125 FORZA (JF69)	125	11	2017 →	FDB570			XRAC/ST/SM/P/EF/CPRO	FDB2212		ST/SM/EF
FS 125 Sonic	125	2003	→ 2004	FDB312			ST/P/EF	FDB2169		P/EF
ANF 125 INNOVA	125	2003	→ 2011	FDB2169			P/EF	FSB704		
NHX Lead	125	2013	→ 2017					FSB963		
MBX 125 RWB	125	1984	→ 1986	FDB312			ST/P/EF	FSB746		
Monkey	125	2019	→	FDB2169			P/EF			
MSX 125	125	7,2	2017 →	FDB2169			P/EF	FDB2275		P/EF
MTX 125 RWD	125	1983	→ 1984	FSB705				FSB705		
MTX 125 R2F	125	1985	→ 1995	FDB382			SG/P	FSB705		
MTX 125 RF	125	1985	→ 1995	FDB382			SG/P	FSB705		

* It is recommended that in those applications where sintered pads are supplied as Original Equipment, replacement pads should also be of sintered composition.

** To avoid brake imbalance sintered pads fitted in rear calipers should only be used in combination with front calipers containing sintered pads.



CC KW FROM -> TO N° SET L/R COMPOUND N° SET L/R COMPOUND

...HONDA

MTX 125 RWF	125	1985	→	1995	FDB382			SG/P	FSB705		
MTX 125 R	125	1987	→	1988	FDB438			P/EF	FSB704		
MTX 125 RII	125	1989	→		FDB438			P/EF	FSB704		
@ 125 NES	125	2000	→		FDB2119			SM/SG/P/EF/AG	FSB963		
@ 125 NES	125	2001	→		FDB382			SG/P	FSB963		
NH 125 LEAD	125	1983	→	1987	FSB704				FSB704		
NH 125 LEAD	125	1988	→						FSB704		
NS 125 F	125	1985	→	1987	FDB438			P/EF	FSB704		
NS 125 R	125	1987	→	1990	FDB438			P/EF	FSB704		
NSR 125 R - F	125	1988	→	1990	FDB438			P/EF	FSB704		
NSR 125 FII	125	1991	→	1993	FDB438			P/EF	FRP416		P
NSR 125 R	125	1991	→	2001	FDB438			P/EF	FRP416		P
NSR 125 F RAIDEN	125	1994	→	1996	FDB438			P/EF	FRP416		P
NSS 125 FORZA (JF60)	125	11	2015	→	FDB570			XRAC/ST/SM/P/EF/CPRO	FDB2212		ST/SM/EF
NX 125	125	1988	→		FSB958				FSB705		
NX 125 TRANSCITY	125	1989	→	1997	FDB495			SG/P	FSB705		
NX 125 (ITALY)	125	1990	→		FDB438			P/EF	FSB704		
NXR 125 BROS	125	2004	→						FSB963		
PCX 125 (WW125 EX2)	125	2010	→	2013	FDB2256			EF	FSB963		
PCX 125 LIMITED EDITION (WW125 EX2)	125	2012	→		FDB2256			EF	FSB963		
PCX 125	125	2018	→		FDB2319			EF			
PCX	125	9	2019	→	FDB2242			P/EF			
PES 125 INJECTION	125	2006	→	2010					FSB963		
PES 125 INJECTION	125	2008	→	2010	FDB2119			SM/SG/P/EF/AG			
PES 125 INJECTION SPORTY	125	2008	→	2009	FDB2119			SM/SG/P/EF/AG	FSB963		
PS 125 i	125	2007	→		FDB2119			SM/SG/P/EF/AG	FSB963		
RS 125 R	125	1987	→	1990	FDB452			ST/P			
RS 125 R	125	1991	→	1994	FDB570	2		XRAC/ST/SM/P/EF/CPRO	FDB2192		AG
RS 125 R	125	1995	→	2010	FDB858	2		ST/CP1	FDB250		SG/P/EF
SH 125 (JF09)	125	10	2001	→	2004	FDB2119		SM/SG/P/EF/AG	FSB963		
SH 125i (JF14)	125	10	2005	→	2007	FDB2119		SM/SG/P/EF/AG	FSB963		
SH 125i (JF23)	125	10	2008	→	2012	FDB2196		ST/SM/P/EF	FDB2212		ST/SM/EF
SH 125i (JF41)	125	9	2013	→		FDB2225		SM/EF	FDB2212		ST/SM/EF
SH 125 Mode (JF51)	125	8	2014	→		FDB2256		EF	FSB963		
SH 125i	125	2020	→		FDB2225			SM/EF	FDB2212		ST/SM/EF
SH 150i	125	2020	→		FDB2225			SM/EF	FDB2212		ST/SM/EF
SH 125 SPECIAL	125	2004	→	2007					FSB963		
SH 125 S	125	2007	→		FDB2119			SM/SG/P/EF/AG	FSB963		
SH 125 R	125	2008	→		FDB2119			SM/SG/P/EF/AG	FSB963		
SH 125 D	125	2009	→		FDB2119			SM/SG/P/EF/AG	FSB963		
SPACY 125	125	2004	→	2007					FSB963		
SPACY 125	125	2007	→		FDB2119			SM/SG/P/EF/AG			
SPACY 125 LEARNING	125	2007	→						FSB963		
Super Cub C125	125	2019	→		FDB2282			EF			
TL 125	125	1976	→		FSB705				FSB705		
TUR/ML 125 (Brasil)	125		→		FDB625			EF			
VT 125 SHADOW	125	1999	→		FDB631			ST/SM/SG/P/EF/AG	FSB709		
XL 125 K2	125	1976	→		FSB705				FSB705		
XL 125 K3	125	1979	→		FSB704				FSB705		
XL 125 S Z-A-B-C	125	1979	→	1983	FSB705				FSB705		
XL 125 R-C	125	1982	→	1982	FSB705				FSB705		
XL 125 R	125	1984	→	1984	FSB704				FSB704		
XL 125 S	125	1984	→	1984	FSB704				FSB704		
XL 125 R	125	1985	→	1986	FDB382			SG/P	FSB705		
XL 125 S	125	1985	→	1987	FSB958				FSB705		
XL 125 R PARIS DAKAR	125	1986	→	1986	FDB382			SG/P	FSB705		
XL 125 R	125	1987	→	1988	FDB438			P/EF	FSB705		
XL 125 L PARIS DAKAR	125	1989	→		FDB438			P/EF	FSB705		
XL 125 PARIS DAKAR	125	1989	→		FDB438			P/EF	FSB705		
XL 125 VARADERO	125	2001	→		FDB631			ST/SM/SG/P/EF/AG	FDB2143		P/EF
XLR 125	125	1993	→		FDB892			ZR/SG/P/EF/CPRO	FDB539		SG/P/EF
XLR 125	125	2003	→						FSB963		
AROBASE 150	150	2000	→	2004					FSB963		
CBF 150	150	2005	→						FSB963		
CBR 150 R	150	2000	→	2003	FDB2169			P/EF	FDB2143		P/EF
CG 150 JOB	150	2004	→	2007					FSB963		
CG 150 TITAN Electric Start	150	2004	→	2010					FSB963		
CG 150 TITAN Kick Start	150	2004	→	2010					FSB963		
CG 150 CARGO	150	2007	→						FSB963		
CG 150 FAN	150	2010	→						FSB963		
CRF 150 F	150	2003	→	2007	FDB892			ZR/SG/P/EF/CPRO	FSB705		
CRF 150 R (Big wheel 19"-16")	150	2007	→	2015	FDB381			SG/P/EF	FDB2139		SG/P/EF
CRF 150 R (Small wheel 17"-14")	150	2007	→	2015	FDB381			SG/P/EF	FDB2139		SG/P/EF
DYLAN 150	150	2002	→	2009					FSB963		

* It is recommended that in those applications where sintered pads are supplied as Original Equipment, replacement pads should also be of sintered composition.

** To avoid brake imbalance sintered pads fitted in rear calipers should only be used in combination with front calipers containing sintered pads.



CC KW FROM -> TO N° SET L/R COMPOUND



N° SET L/R COMPOUND

...HONDA

DYLAN 150 REPSOL	150	2002	→					FSB963			
FES 150 PANTHEON	150	1998	→ 1999	FDB2073			ST/SM/P/EF	FSB946			
FES 150 PANTHEON	150	2000	→ 2002	FDB2075			ST/SM/P/EF	FSB946			
FES 150 PANTHEON	150	2003	→ 2006	FDB2075			ST/SM/P/EF	FDB531			ST/P/EF
FES 150 S-WING	150	2007	→ 2013	FDB2196			ST/SM/P/EF	FDB2212			ST/SM/EF
@ 150 NES	150	2000	→	FDB2119			SM/SG/P/EF/AG	FSB963			
NSR 150	150	2001	→ 2003	FDB631			ST/SM/SG/P/EF/AG	FDB497			ST/SM/SG/P/EF
NX 150 (Brasil)	150		→	FDB892			ZR/SG/P/EF/CPRO				
NXR 150 BROS	150	2009	→ 2011					FSB963			
PCX 150 (WW150)	150	2012	→	FDB2256			EF	FSB963			
PCX 150 ABS	150	2018	→					FSB963			
PES 150 INJECTION	150	2006	→ 2010					FSB963			
PES 150 INJECTION	150	2008	→ 2010	FDB2119			SM/SG/P/EF/AG				
PES 150 R TWO TONES	150	2008	→ 2009	FDB2119			SM/SG/P/EF/AG	FSB963			
PES 150 R INJECTION	150	2010	→	FDB2119			SM/SG/P/EF/AG	FSB963			
PS 150i	150	2008	→	FDB2119			SM/SG/P/EF/AG	FSB963			
SH 150 (KF04)	150	12	2001 → 2004	FDB2119			SM/SG/P/EF/AG	FSB963			
SH 150 SPECIAL 2ED	150	2004	→ 2006					FSB963			
SH 150 (KF08)	150	12	2005 → 2008	FDB2119			SM/SG/P/EF/AG	FSB963			
SH 150 R	150	2008	→	FDB2119			SM/SG/P/EF/AG	FSB963			
SH 150 S	150	2008	→	FDB2119			SM/SG/P/EF/AG	FSB963			
SH 150i (KF10)	150	12	2009 → 2012	FDB2196			ST/SM/P/EF	FDB2212			ST/SM/EF
SH 150i (KF13)	150	11	2013 →	FDB2225			SM/EF	FDB2212			ST/SM/EF
CB 175 all models	175	1974	→ 1976					FSB749			
CD 175 all models	175	1971	→ 1978	FSB760							
CD 185 T	185	1978	→ 1980	FSB707				FSB706			
XL 185 S	185	1979	→ 1981	FSB705				FSB705			
CB 200 B - T	200	1977	→ 1979					FSB749			
CBX 200 STRADA	200	13	→	FDB625			EF				
CD 200 T	200	1979	→ 1980	FSB707				FSB706			
CM 200 TA - TB	200	1980	→ 1981	FSB707				FSB706			
CT 200 E - K	200	1984	→ 1989	FSB704				FSB705			
CT 200 P	200	1993	→ 1999	FSB705				FSB705			
CTX 200	200	2003	→ 2004	FDB892			ZR/SG/P/EF/CPRO	FSB705			
MTX 200 RWD	200	1983	→ 1984	FSB705				FSB705			
MTX 200 RW	200	1985	→ 1986	FDB382			SG/P	FSB705			
MTX 200 R	200	1987	→	FDB438			P/EF	FSB704			
NX 200 (Brasil)	200		→	FDB892			ZR/SG/P/EF/CPRO				
TA 200	200	2003	→ 2004	FDB631			ST/SM/SG/P/EF/AG	FDB631			ST/SM/SG/P/EF/AG
TL 200 J	200		→	FSB705				FSB705			
TL 200 X	200		→	FSB705				FSB705			
TLR 200 EF	200	1984	→	FSB714				FSB714			
XL 200 R	200	1983	→ 1984	FSB705				FSB705			
XL 200 R	200	1985	→	FDB438			P/EF	FSB704			
XLR 200 R	200	1993	→	FDB892			ZR/SG/P/EF/CPRO	FDB539			SG/P/EF
XR 200 (Brasil)	200		→	FDB892			ZR/SG/P/EF/CPRO				
XR 200 A - RB - RC - RD	200	1981	→ 1983	FSB705				FSB705			
XR 200 R	200	1984	→ 1991	FSB705				FSB705			
CB 223 S	223	2008	→ 2016					FSB963			
FTR 223	223	2000	→ 2016					FSB963			
CRF 230 F	230	2003	→ 2007	FDB892			ZR/SG/P/EF/CPRO	FSB705			
CRF 230 F	230	2008	→	FDB892			ZR/SG/P/EF/CPRO	FDB539			SG/P/EF
EASY 230 Enduro /SM	230	2008	→	FDB892			ZR/SG/P/EF/CPRO	FDB539			SG/P/EF
SL 230	230	1997	→	FDB892			ZR/SG/P/EF/CPRO				
XL 230	230	2002	→					FSB963			
AX 1 250	250	1988	→	FDB495			SG/P				
CB 250	250	1973	→ 1975	FSB943				FSB742			
CB 250 G5	250	1974	→ 1976	FDB119			P	FSB742			
CB 250 N	250	1978	→ 1982	FDB183			P	FSB708			
CB 250 T	250	1978	→ 1982	FDB183			P	FSB708			
CB 250 RS	250	1981	→ 1984	FDB183			P	FSB749			
REBEL 250	250	1986	→	FDB312			ST/P/EF				
CB 250	250	1988	→ 1991	FDB452			ST/P	FSB708			
CB 250 JADE	250	1991	→	FDB570	2		XRAC/ST/SM/P/EF/CPRO	FDB531			ST/P/EF
CB 250 NIGHT HAWK	250	1991	→ 2001	FDB570			XRAC/ST/SM/P/EF/CPRO	FSB706			
CB 250 TWO FIFTY	250	1993	→ 2005	FDB570			XRAC/ST/SM/P/EF/CPRO	FSB706			
CB 250 F/HORNET	250	1996	→ 2001	FDB533			XRAC/ST/P/CP1	FDB531			ST/P/EF
CBF 250	250	2004	→ 2009					FSB963			
CBR 250 F	250	2004	→	FDB462			ST/P				
CBR 250 R HURRICANE	250	1986	→ 1988	FDB462	2		ST/P	FDB531			ST/P/EF
CBR 250 R - RR	250	1990	→ 1994	FDB533	2		XRAC/ST/P/CP1	FDB531			ST/P/EF
CBR 250 R	250	2011	→	FDB570			XRAC/ST/SM/P/EF/CPRO	FDB2258			ST/EF
CBR 250 R ABS	250	2011	→	FDB2196			ST/SM/P/EF	FDB2258			ST/EF
CBX 250 F	250	1995	→	FDB570			XRAC/ST/SM/P/EF/CPRO				

HONDA

* It is recommended that in those applications where sintered pads are supplied as Original Equipment, replacement pads should also be of sintered composition.

** To avoid brake imbalance sintered pads fitted in rear calipers should only be used in combination with front calipers containing sintered pads.



CC KW FROM -> TO



N° SET L/R COMPOUND



N° SET L/R COMPOUND

...HONDA

CBX 250 TWISTER	250	2001	→ 2008					FSB963			
CD 250	250	1988	→ 1992	FDB663	2		ST/P/EF	FSB706			
CH 250 ELITE/SPACY	250	1985	→ 1986	FDB382			SG/P	FSB748			
CH 250 ELITE/SPACY	250	1987	→ 1990	FSB958				FSB958			
CJ 250 I	250	1977	→	FDB119			P	FSB742			
CL 250 SC	250	1981	→	FSB707				FSB749			
CM 250 C	250	1982	→	FSB707				FSB706			
CM 250 TB	250	1981	→	FDB183			P	FSB708			
CMX 250 C REBEL	250	1996	→ 2000	FDB497			ST/SM/SG/P/EF	FSB709			
CN 250 HELIX-FUSION	250	1986	→ 1987	FDB244			ST/P/EF	FSB732			
CN 250 HELIX-FUSION	250	1988	→ 1989	FDB382			SG/P	FSB762			
CN 250 HELIX-FUSION	250	1990	→ 1992	FDB538			P	FSB762			
CN 250 HELIX-FUSION	250	1992	→ 1993	FDB382			SG/P	FSB748			
CN 250 HELIX-FUSION	250	1993	→ 2000	FDB538			P	FSB958			
CR 250 RS	250		→ 1978	FSB744				FSB750			
CR 250 RZ-A	250	1979	→ 1980	FSB747				FSB743			
CR 250 RB	250	1981	→ 1981	FSB744				FSB958			
CR 250 RC	250	1982	→ 1982	FSB745				FSB958			
CR 250 RD	250	1983	→ 1983	FSB745				FSB746			
CR 250 RE-F	250	1984	→ 1985	FDB382			SG/P	FSB746			
CR 250 RG	250	1986	→ 1986	FDB382			SG/P	FSB757			
CR 250 R	250	1987	→ 1994	FDB495			SG/P	FDB539			SG/P/EF
CR 250 R	250	1996	→ 2001	FDB892			ZR/SG/P/EF/CPRO	FDB539			SG/P/EF
CR 250 R	250	2002	→ 2007	FDB892			ZR/SG/P/EF/CPRO	FDB2139			SG/P/EF
CRF 250 R	250	2004	→	FDB892			ZR/SG/P/EF/CPRO	FDB2139			SG/P/EF
CRF 250 X	250	2004	→ 2017	FDB892			ZR/SG/P/EF/CPRO	FDB2139			SG/P/EF
CRF 250 LD	250	18	2013	→	FDB2242		P/EF	FDB2275			P/EF
CRF 250 M Supermoto	250		2014	→	FDB2242		P/EF	FDB2275			P/EF
CRF 250 Rallye	250	18	2015	→	FDB2169		P/EF	FDB2275			P/EF
CRM 250 R	250	1989	→ 1990	FDB495			SG/P	FDB539			SG/P/EF
CRM 250 R	250	1991	→	FDB892			ZR/SG/P/EF/CPRO	FDB539			SG/P/EF
FES 250 FORESIGHT	250	1997	→ 1998	FDB2073			ST/SM/P/EF	FSB946			
FES 250 FORESIGHT	250	1999	→	FDB2075			ST/SM/P/EF	FSB531			ST/P/EF
FTR 250	250	1986	→	FDB382			SG/P	FDB382			SG/P
JAZZ 250	250	2001	→	FDB2073			ST/SM/P/EF	FDB2130			AG
MVX 250 F	250	1988	→	FDB310			P	FSB749			
NS 250 RF	250	1984	→ 1986	FDB244	2		ST/P/EF	FDB244			ST/P/EF
NSR 250	250	1986	→	FDB462			ST/P	FDB244			ST/P/EF
NSR 250 R	250	1986	→ 1987	FDB462	2		ST/P	FDB244			ST/P/EF
NSR 250 R	250	1988	→ 1993	FDB533			XRAC/ST/P/CP1	FDB531			ST/P/EF
NSR 250 R SP	250	1988	→ 1993	FDB533			XRAC/ST/P/CP1	FDB531			ST/P/EF
NSR 250 R SE	250	1994	→ 1996	FDB858			ST/CP1	FDB496			P
NSR 250 R SP	250	1994	→ 1996	FDB858			ST/CP1	FDB496			P
NSS 250 FORZA (MF04/06)	250	2000	→ 2004	FDB2075			ST/SM/P/EF	FDB754			ST/P/EF
NSS 250 FORZA EX (ABS)	250	2005	→ 2008	FDB2196			ST/SM/P/EF	FDB2212			ST/SM/EF
NSS 250 FORZA X	250	2005	→ 2008	FDB2196			ST/SM/P/EF	FDB2212			ST/SM/EF
NSS 250 FORZA Z (ABS)	250	2005	→ 2006	FDB2196			ST/SM/P/EF	FDB2196			ST/SM/P/EF
NX 250	250	1988	→ 1990	FDB495			SG/P	FSB740			
NX 250 DOMINATOR	250	1988	→ 1990	FDB495			SG/P	FSB740			
NX 250 DOMINATOR	250	1991	→ 1993	FDB892			ZR/SG/P/EF/CPRO	FSB740			
RS 250 R	250	1991	→	FDB533	2		XRAC/ST/P/CP1	FDB531			ST/P/EF
RS 250	250	1993	→ 1994	FDB858	2		ST/CP1	FDB2192			AG
RS 250 R	250	1995	→					FDB250			SG/P/EF
RTL 250 SG	250	1986	→	FSB705				FSB705			
RX 250 RE	250	1984	→	FDB382			SG/P	FSB705			
TL 250 KI	250	1979	→	FSB705				FSB705			
TL 250 F	250	1985	→	FSB705				FSB705			
TSR 250	250	1999	→	FRP408			XRAC/ST/PRP/P/CPRO/CP1				
VT 250 F-II	250	1982	→ 1982	FDB538			P	FSB749			
VT 250 Z	250	1982	→ 1987	FDB310			P	FSB749			
VT 250 F-II	250	1983	→ 1984	FDB310			P	FSB749			
VT 250 F INTEGRA	250	1987	→	FDB462			ST/P	FSB749			
VT 250 SPADA	250	1988	→	FDB570			XRAC/ST/SM/P/EF/CPRO	FDB531			ST/P/EF
VT 250 CR MAGNA	250	1994	→	FDB570	2		XRAC/ST/SM/P/EF/CPRO				
VTR 250 (MC33)	250	1998	→ 2009	FDB664			ST/P/EF	FDB531			ST/P/EF
VTZ 250	250	1988	→	FDB452			ST/P	FSB749			
VTZ 250 XELVIS	250	1992	→	FDB570			XRAC/ST/SM/P/EF/CPRO	FDB606			P
XL 250 K3 - K4	250	1978	→ 1979	FSB942				FSB707			
XL 250 S	250	1978	→ 1981	FSB707				FSB740			
XL 250 R	250	1982	→ 1988	FSB958				FSB740			
XL 250 S	250	1982	→ 1990	FSB707				FSB709			
XL 250	250	1990	→ 1990	FDB495			SG/P	FDB539			SG/P/EF
XL 250	250	1991	→	FDB495			SG/P	FSB740			
XL 250 DEGREE	250	1991	→ 1997	FDB892			ZR/SG/P/EF/CPRO	FSB740			

* It is recommended that in those applications where sintered pads are supplied as Original Equipment, replacement pads should also be of sintered composition.

** To avoid brake imbalance sintered pads fitted in rear calipers should only be used in combination with front calipers containing sintered pads.



CC KW FROM -> TO N° SET L/R COMPOUND N° SET L/R COMPOUND

...HONDA

XLR 250 R	250	1985	→ 1988	FDB382			SG/P	FSB704		
XLR 250 R BAJA	250	1988	→ 1990	FDB495			SG/P	FDB539		SG/P/EF
XLR 250 R	250	1991	→	FDB892			ZR/SG/P/EF/CPRO	FDB539		SG/P/EF
XLR 250 R BAJA	250	1991	→	FDB892			ZR/SG/P/EF/CPRO	FDB539		SG/P/EF
XLX 250	250	1984	→	FSB958				FSB740		
XR 250 Z - SZ - SA	250	1979	→ 1980	FSB707				FSB740		
XR 250 RB - RD	250	1981	→ 1983	FSB744				FSB740		
XR 250 RE - RH	250	1984	→ 1987	FDB382			SG/P	FSB740		
XR 250 R	250	1988	→ 1993	FDB495			SG/P	FDB539		SG/P/EF
XR 250 L	250	1991	→ 1995	FDB892			ZR/SG/P/EF/CPRO	FDB539		SG/P/EF
XR 250 R	250	1994	→	FDB892			ZR/SG/P/EF/CPRO	FDB539		SG/P/EF
XR 250 TORNADO	250	2001	→ 2009					FSB963		
CB 300 R	300	23	2018 →	FDB2294			ST	FDB2275		P/EF
CBR300R	300		2014 →	FDB664			ST/P/EF	FDB2258		ST/EF
NSS 300 FORZA	300	18	2019 →	FDB570			XRAC/ST/SM/P/EF/CPRO	FDB2212		ST/SM/EF
NSS 300 FORZA (NF04)	300	18	2013 →	FDB2196			ST/SM/P/EF	FDB2212		ST/SM/EF
SH 300i (NF02)	300	20	2007 → 2014	FDB2196			ST/SM/P/EF	FDB2212		ST/SM/EF
SH 300i ABS (NF05)	300	19	2015 →	FDB2225			SM/EF	FDB2212		ST/SM/EF
CB 350 K4	350		→	FSB943				FSB742		
CB 350 SG	350	1986	→	FDB462	2		ST/P	FSB708		
NX 350 SAHARA (Brasil)	350		→ 1999	FDB892			ZR/SG/P/EF/CPRO			
XL 350 R	350	1983	→ 1984	FSB746				FSB705		
XL 350 R	350	1985	→ 1985	FDB382			SG/P	FSB740		
XLX 350	350	1989	→	FDB382			SG/P			
XR 350 RE - RD	350	1984	→	FDB382			SG/P	FSB705		
CB 360 G5 all models	360	1975	→	FSB943				FSB742		
CJ 360 T all models	360	1978	→	FDB119			P	FSB742		
CB 400 N/F	400	1983	→	FDB538			P	FSB708		
CB 400 SUPER FOUR	400	1992	→	FDB570	2		XRAC/ST/SM/P/EF/CPRO	FDB531		ST/P/EF
CB 400 SUPER FOUR S	400	1997	→ 1998	FDB2042	2		ZRAC/XRAC/ST/P/EF/CPRO	FDB531		ST/P/EF
CB 400 SUPER FOUR (SF)	400	1999	→ 2003	FDB2079	2		ZRAC/XRAC/ST/P/EF/CPRO/CP1	FDB2111		ST/P/EF
CB 400 A - HAWK	400	1978	→	FDB183			P	FSB708		
CB 400 F - F1 - F2	400	1975	→ 1979	FDB119			P	FSB742		
CB-1 400 F	400	1989	→	FDB570			XRAC/ST/SM/P/EF/CPRO	FDB531		ST/P/EF
CB 400 FK (CB-1)	400	1990	→	FDB570	2		XRAC/ST/SM/P/EF/CPRO	FDB531		ST/P/EF
CB 400 N - NA - NB	400	1978	→ 1982	FDB182	2		P	FSB708		
CBR 400 RG (NC23) 100	400	1986	→ 1986	FDB462	2		ST/P	FDB244		ST/P/EF
CBR 400 RH-YA (NC23) 101	400	1986	→ 1986	FDB462	2		ST/P	FDB244		ST/P/EF
CBR 400 RR/JRRK (NC23) Tri-Arm (102/109)	400	1987	→ 1989	FDB570	2		XRAC/ST/SM/P/EF/CPRO	FDB531		ST/P/EF
CBR 400 RRL/RRN/RRR (NC29) Gull Arm	400	1990	→ 1994	FDB570	2		XRAC/ST/SM/P/EF/CPRO	FDB531		ST/P/EF
CBX 400 C	400	1983	→	FDB538			P	FDB244		ST/P/EF
CM 400 A	400	1978	→ 1981	FDB182	2		P	FSB708		
CM 400 AA	400	1978	→ 1981	FDB182	2		P	FSB708		
CM 400 AB-TA	400	1978	→ 1981	FDB182	2		P	FSB708		
CM 400 T	400	1978	→ 1981	FDB182	2		P	FSB708		
CM 400 TB	400	1978	→	FDB182	2		P	FSB708		
CM 400 TC	400	1978	→ 1981	FDB182	2		P	FSB708		
CM 400 TZ	400	1978	→	FDB182	2		P	FSB708		
FL 400 R PILOT (4W)	400	1989	→ 1990	FSB925						
FT 400	400	1982	→	FDB244			ST/P/EF	FDB244		ST/P/EF
NS 400 RF - RG	400	1985	→	FDB538	2		P	FDB244		ST/P/EF
NTV 400 BROS	400	1988	→	FDB533			XRAC/ST/P/CP1	FDB531		ST/P/EF
NV 400 CUSTOM	400	1988	→	FDB663			ST/P/EF	FDB665		ST/P
NV 400 SP CUSTOM	400	1988	→					FDB244		ST/P/EF
RVF 400	400	1994	→	FDB858	2		ST/CP1	FDB496		P
Silver Wing 400 (FJS400)	400	2002	→	FDB2073			ST/SM/P/EF	FDB570		XRAC/ST/SM/P/EF/CPRO
Silver Wing GT400 (FJS400D)	400	2003	→ 2008	FDB2073			ST/SM/P/EF	FDB570		XRAC/ST/SM/P/EF/CPRO
Silver Wing GT400 ABS (FJS400A)	400	2003	→ 2008	FDB2073			ST/SM/P/EF	FDB570		XRAC/ST/SM/P/EF/CPRO
Silver Wing GT400 (FJS400D)	400	2009	→ 2017	FDB2196			ST/SM/P/EF	FDB570		XRAC/ST/SM/P/EF/CPRO
Silver Wing GT400 ABS (FJS400A)	400	2009	→ 2017	FDB2196			ST/SM/P/EF	FDB570		XRAC/ST/SM/P/EF/CPRO
SILVERWING 400	400	2006	→	FDB2073			ST/SM/P/EF	FDB570		XRAC/ST/SM/P/EF/CPRO
SW-T 400	400	2009	→	FDB2196			ST/SM/P/EF	FDB570		XRAC/ST/SM/P/EF/CPRO
TRANSALP 400	400	1992	→	FDB452			ST/P	FDB531		ST/P/EF
VF 400 F INTEGRA	400	1982	→	FDB538			P	FDB244		ST/P/EF
VFR 400 R	400	1986	→ 1987	FDB462	2		ST/P	FDB244		ST/P/EF
VFR 400 R	400	1987	→ 1989	FDB462	2		ST/P	FDB531		ST/P/EF
VTR 400 R (NC 30)	400	1989	→ 1991	FDB533	2		XRAC/ST/P/CP1	FDB496		P
XR 400 R (All Models)	400	1996	→	FDB892			ZR/SG/P/EF/CPRO	FDB539		SG/P/EF
XR 400 SUPERMOTARD	400	2000	→	FDB570			XRAC/ST/SM/P/EF/CPRO	FDB539		SG/P/EF
XR 440 R (DALL'ARA)	440	1999	→	FDB892			ZR/SG/P/EF/CPRO	FDB539		SG/P/EF
CB 450 N	450	1985	→	FDB183	2		P	FSB708		
CBX 450 S	450	1987	→	FDB462	2		ST/P	FSB708		
CMX 450 CG REBEL	450	1986	→ 1988	FDB244			ST/P/EF	FSB708		
CR 450 RB	450	1981	→ 1981	FSB744				FSB750		

* It is recommended that in those applications where sintered pads are supplied as Original Equipment, replacement pads should also be of sintered composition.

** To avoid brake imbalance sintered pads fitted in rear calipers should only be used in combination with front calipers containing sintered pads.



CC KW FROM -> TO N° SET L/R COMPOUND N° SET L/R COMPOUND

...HONDA

CRF 450 SUPERMOTARD	450	2002	-	FDB892			ZR/SG/P/EF/CPRO	FDB2139			SG/P/EF
CRF 450 Rally	450	2013	-	FDB892			ZR/SG/P/EF/CPRO				
CRF 450 L	450	18	2019	-	FDB892		ZR/SG/P/EF/CPRO	FDB2139			SG/P/EF
CRF 450 R	450	2002	-	FDB892			ZR/SG/P/EF/CPRO	FDB2139			SG/P/EF
CRF 450 R	450	2017	-	FDB892			ZR/SG/P/EF/CPRO	FDB2139			SG/P/EF
CRF 450 RX	450	2017	-	FDB892			ZR/SG/P/EF/CPRO	FDB2139			SG/P/EF
CRF 450 X	450	2005	-	2013	FDB892		ZR/SG/P/EF/CPRO	FDB2139			SG/P/EF
CMX 500 Rebel S	471	34	2020	-	FDB570		XRAC/ST/SM/P/EF/CPRO	FDB531			ST/P/EF
CR 480 RC	480	1982	-	1982	FSB744			FSB814			
CR 480 RD	480	1983	-	1983	FSB745			FSB746			
CB 500 F	500	35	2019	-	FDB570		XRAC/ST/SM/P/EF/CPRO	FDB531			ST/P/EF
CB 500 F (PC45)	500	35	2013	-	FDB570		XRAC/ST/SM/P/EF/CPRO	FDB531			ST/P/EF
CB 500 K1 - K2 - T	500	1975	-	1977	FDB119		P	FSB711			
CB 500 R/T	500	1994	-	1996	FDB570		XRAC/ST/SM/P/EF/CPRO	FSB711			
CB 500 S	500	1999	-	2003	FDB2006	2	ST/P/EF	FDB2005			ST/SG/P/EF
CB 500 V	500	1997	-	2003	FDB2006		ST/P/EF	FDB2005			ST/SG/P/EF
CB 500 X (PC46)	500	35	2013	-	FDB570		XRAC/ST/SM/P/EF/CPRO	FDB531			ST/P/EF
CBF 500	500	2004	-	FDB664			ST/P/EF	FDB754			ST/P/EF
CBF 500 ABS	500	2004	-	2007	FDB2196		ST/SM/P/EF	FDB754			ST/P/EF
CBR 500	500	1987	-	1990	FDB462	2	ST/P	FDB665			ST/P
CBR 500 R	500	35	2013	-	2015	FDB570	XRAC/ST/SM/P/EF/CPRO	FDB531			ST/P/EF
CBR 500 R	500	35	2016	-	FDB664		ST/P/EF	FDB531			ST/P/EF
CMX 500 Rebel	500	34	2019	-	FDB570		XRAC/ST/SM/P/EF/CPRO	FDB531			ST/P/EF
CR 500 RE-F	500	1984	-	1985	FDB382		SG/P	FSB746			
CR 500 RG	500	1986	-	1986	FDB382		SG/P	FSB757			
CR 500 R	500	1987	-	1992	FDB495		SG/P	FDB539			SG/P/EF
CR 500 R	500	1993	-	1994	FDB892		ZR/SG/P/EF/CPRO	FDB539			SG/P/EF
CR 500 R	500	1995	-	2001	FDB892		ZR/SG/P/EF/CPRO	FDB539			SG/P/EF
CX 500 CA - CB	500	1979	-	1981	FDB182	2	P	FSB711			
CX 500 CC - EC	500	1982	-	FDB244	2	ST/P/EF	FDB244				ST/P/EF
CX 500 T (TURBO)	500	1983	-	FDB244	2	ST/P/EF	FDB244				ST/P/EF
FT 500 - C	500	1982	-	FDB244		ST/P/EF	FDB244				ST/P/EF
GL 500 DC	500	1982	-	FDB244	2	ST/P/EF	FSB711				
GL 500 SILVER WING INTERSTATE	500	1982	-	FDB244	2	ST/P/EF	FSB711				
NX 500 DOMINATOR	500	1988	-	1996	FDB663		ST/P/EF	FDB531			ST/P/EF
NX 500 DOMINATOR	500	1997	-	1999	FDB2006		ST/P/EF	FDB2005			ST/SG/P/EF
VF 500 FE - F2E	500	1984	-	FDB244	2	ST/P/EF	FDB665				ST/P
VF 500 FF - F2F	500	1984	-	FDB244	2	ST/P/EF	FDB665				ST/P
VT 500 CD - FT	500	1982	-	FDB244		ST/P/EF	FSB708				
VT 500 ED - EF - C	500	1983	-	FDB310		P	FSB708				
XBR 500 S - F - G - H	500	1985	-	FDB244		ST/P/EF	FSB755				
XL 500 S	500	1979	-	1979	FSB707			FSB709			
XL 500 S	500	1980	-	1981	FSB743			FSB749			
XL 500 R	500	1982	-	1984	FSB751			FSB709			
XL 500 R PARIS DAKAR	500	1982	-	1984	FSB751			FSB709			
XR 500 SA - SZ	500	1979	-	1980	FSB747			FSB709			
XR 500 R - RB	500	1981	-	1983	FSB744			FSB709			
XR 500 R	500	1983	-	1984	FDB382		SG/P	FSB709			
XR 500 R	500	1984	-	FDB382		SG/P	FSB705				
CB 550 F - F1 - F2	550	1978	-	FDB119		P		FSB741			
CB 550 K3	550	1978	-	FDB119		P		FSB741			
CBX 550 FC - FD - F2C - F2D	550	1982	-	1984	FDB310	2	P	FDB310			P
CB 600 F HORNET (16 wheel)	600	1998	-	1999	FDB570	2	XRAC/ST/SM/P/EF/CPRO	FDB754			ST/P/EF
CB 600 F HORNET (Japan)	600	1998	-	FDB2114		XRAC/ST/P	FDB754				ST/P/EF
CB 600 F HORNET (17 wheel)	600	2000	-	2006	FDB570	2	XRAC/ST/SM/P/EF/CPRO	FDB754			ST/P/EF
CB 600 F HORNET S (17 wheel)	600	2000	-	2004	FDB570	2	XRAC/ST/SM/P/EF/CPRO	FDB754			ST/P/EF
CB 600 F HORNET	600	2007	-	FDB570	2	XRAC/ST/SM/P/EF/CPRO	FDB2221				ST/P
CB 600 F HORNET ABS	600	2007	-	FDB2196	2	ST/SM/P/EF	FDB754				ST/P/EF
CBF 600 4/A4/Travel	600	2004	-	FDB570	2	XRAC/ST/SM/P/EF/CPRO	FDB754				ST/P/EF
CBF 600 N / S / ABS	600	2008	-	FDB2196	2	ST/SM/P/EF	FDB754				ST/P/EF
CBF 600 S/ABS	600	2011	-	FDB664	2	ST/P/EF	FDB754				ST/P/EF
CBR 600 F/R HURRICANE	600	1987	-	1990	FDB462	2	ST/P	FDB665			ST/P
CBR 600 F2	600	1991	-	1994	FDB2113	2	P	FDB754			ST/P/EF
CBR 600 F3	600	1995	-	1998	FDB664	2	ST/P/EF	FDB754			ST/P/EF
CBR 600 F (Japan)	600	1999	-	2004	FDB2114	2	XRAC/ST/P	FDB754			ST/P/EF
CBR 600 F4 / F4i Sport	600	1999	-	2004	FDB2079	2	ZRAC/XRAC/ST/P/EF/CPRO/CP1	FDB754			ST/P/EF
CBR 600 FX / FY	600	1999	-	2000	FDB2079	2	ZRAC/XRAC/ST/P/EF/CPRO/CP1	FDB754			ST/P/EF
CBR 600 F1 / F2 / FS1 / FS2 Sport	600	2001	-	2002	FDB2079	2	ZRAC/XRAC/ST/P/EF/CPRO/CP1	FDB754			ST/P/EF
CBR 600 F	600	2007	-	FDB2079	2	ZRAC/XRAC/ST/P/EF/CPRO/CP1	FDB754				ST/P/EF
CBR 600 F / ABS	600	2011	-	FDB664	2	ST/P/EF	FDB2221				ST/P
CBR 600 RR	600	2003	-	2004	FDB2079	2	ZRAC/XRAC/ST/P/EF/CPRO/CP1	FDB754			ST/P/EF
CBR 600 RR	600	2005	-	2006	FDB2181	2	XRAC/ST	FDB754			ST/P/EF
CBR 600 RR (Racing spec.)	600	2005	-	2005	FDB2205	2	ZRAC/CPRO	FDB754			ST/P/EF
CBR 600 RR / Lim. Ed. / Fireblade Repsol	600	2007	-	FDB2181	2	XRAC/ST	FDB2221				ST/P

* It is recommended that in those applications where sintered pads are supplied as Original Equipment, replacement pads should also be of sintered composition.

** To avoid brake imbalance sintered pads fitted in rear calipers should only be used in combination with front calipers containing sintered pads.



	CC	KW	FROM -> TO		N° SET	L/R	COMPOUND		N° SET	L/R	COMPOUND
...HONDA											
NTV 600 BROSS	600		1988 → 1992	FDB533			XRAC/ST/P/CP1	FDB531			ST/P/EF
NTV 600 REVERSE - HAWK	600		1990 → 1992	FDB570			XRAC/ST/SM/P/EF/CPRO	FDB531			ST/P/EF
NV 600 C	600		1988 →	FDB663			ST/P/EF	FSB711			
Silver Wing 600 (FJS600)	600		2001 → 2002	FDB2073			ST/SM/P/EF	FDB570			XRAC/ST/SM/P/EF/CPRO
Silver Wing 600 (FSC600)	600		2002 → 2007	FDB2073			ST/SM/P/EF	FDB570			XRAC/ST/SM/P/EF/CPRO
Silver Wing (FSC600D)	600		2003 → 2008	FDB2073			ST/SM/P/EF	FDB570			XRAC/ST/SM/P/EF/CPRO
Silver Wing 600 (FJS600D)	600		2003 → 2008	FDB2073			ST/SM/P/EF	FDB570			XRAC/ST/SM/P/EF/CPRO
Silver Wing GT ABS (FJS600A)	600		2003 → 2008	FDB2073			ST/SM/P/EF	FDB570			XRAC/ST/SM/P/EF/CPRO
Silver Wing 600 (FJS600D)	600		2009 → 2010	FDB2196			ST/SM/P/EF	FDB570			XRAC/ST/SM/P/EF/CPRO
Silver Wing GT ABS (FJS600A)	600		2009 → 2017	FDB2196			ST/SM/P/EF	FDB570			XRAC/ST/SM/P/EF/CPRO
Silver Wing GT600 ABS (FSC600A)	600		2009 → 2017	FDB2073			ST/SM/P/EF	FDB570			XRAC/ST/SM/P/EF/CPRO
SILVER WING 600 (FJS)	600		2001 → 2008	FDB2073			ST/SM/P/EF	FDB570			XRAC/ST/SM/P/EF/CPRO
SW-T 600 ABS	600		2011 →	FDB2196			ST/SM/P/EF	FDB570			XRAC/ST/SM/P/EF/CPRO
VLX 600 SHADOW	600		1988 → 1991	FDB663	2		ST/P/EF	FSB711			
VT 600 C SHADOW	600		1988 → 1993	FDB663			ST/P/EF	FSB711			
VT 600 C SHADOW	600		1994 → 2003	FDB570			XRAC/ST/SM/P/EF/CPRO	FSB711			
XL 600 L - PARIS DAKAR	600		1983 → 1984	FDB382			SG/P	FSB709			
XL 600 R	600		1983 → 1984	FDB382			SG/P	FSB709			
XL 600 LM	600		1985 → 1990	FDB244			ST/P/EF	FSB709			
XL 600 RM	600		1986 → 1990	FDB244			ST/P/EF	FSB709			
XL 600 V TRANSALP	600		1987 → 1990	FDB244			ST/P/EF	FSB709			
XL 600 V TRANSALP	600		1991 → 1993	FDB663			ST/P/EF	FDB531			ST/P/EF
XL 600 V TRANSALP	600		1994 → 1996	FDB570			XRAC/ST/SM/P/EF/CPRO	FDB531			ST/P/EF
XL 600 V TRANSALP	600		1997 → 1999	FDB892	2		ZR/SG/P/EF/CPRO	FDB531			ST/P/EF
XR 600 R	600		1985 → 1987	FDB382			SG/P	FSB705			
XR 600 R	600		1988 → 1990	FDB495			SG/P	FSB705			
XR 600 R	600		1991 → 1993	FDB495			SG/P	FDB539			SG/P/EF
XR 600 L - R	600		1994 → 2002	FDB892			ZR/SG/P/EF/CPRO	FDB539			SG/P/EF
CB 650	650		→	FDB310			P	FDB310			P
CB 650 A - Z	650		1979 → 1981	FDB183			P	FSB710			
CB 650 SCC NIGHTHAWK	650		1982 →					FSB710			
CB 650 SCD	650		1983 →	FDB244	2		ST/P/EF	FSB711			
CB 650 R	650	70	2019 →	FDB2294	2		ST	FDB2258			ST/EF
CB 650 B	650		1979 → 1981	FDB183	2		P	FSB710			
CB 650 F (RC75)	650	64	2014 →	FDB570	2		XRAC/ST/SM/P/EF/CPRO	FDB2258			ST/EF
CBR 650 F	650		2014 →	FDB664	2		ST/P/EF	FDB2258			ST/EF
CBX 650 ED	650		1983 →	FDB244	2		ST/P/EF	FSB711			
CX 650 ED	650		1982 →	FDB244			ST/P/EF	FSB711			
CX 650 EC - T	650		1983 →	FDB244	2		ST/P/EF	FDB244			ST/P/EF
CX 650 TD (TURBO) E	650		1983 →	FDB244	2		ST/P/EF	FDB244			ST/P/EF
FMX 650	650		2005 → 2006	FDB664			ST/P/EF	FDB754			ST/P/EF
FMX 650	650		2007 →	FDB664			ST/P/EF	FDB531			ST/P/EF
GL 650 D2TE	650		1983 →	FDB244	2		ST/P/EF	FSB711			
GL 650 DD - ID	650		1983 →	FDB244	2		ST/P/EF	FSB711			
NT 650 HAWK GT	650		1988 → 1990	FDB570	2		XRAC/ST/SM/P/EF/CPRO	FDB531			ST/P/EF
NT 650 V DEAUVILLE	650		1998 → 2001	FDB2006	2		ST/P/EF	FDB531			ST/P/EF
NT 650 DEAUVILLE	650		2002 →	FDB2098	2		ST/P/EF	FDB2098			ST/P/EF
NTV 650 REVERSE	650		1988 → 1993	FDB570			XRAC/ST/SM/P/EF/CPRO	FDB531			ST/P/EF
NTV 650 BROS - I	650		1990 → 1993	FDB533	2		XRAC/ST/P/CP1	FDB531			ST/P/EF
NTV 650	650		1994 → 1997	FDB570	2		XRAC/ST/SM/P/EF/CPRO	FDB531			ST/P/EF
NX 650 DOMINATOR	650		1988 → 1992	FDB663			ST/P/EF	FDB531			ST/P/EF
NX 650 DOMINATOR	650		1993 → 1994	FDB452			ST/P	FDB531			ST/P/EF
NX 650 DOMINATOR	650		1995 → 1997	FDB892			ZR/SG/P/EF/CPRO	FDB531			ST/P/EF
NX 650 DOMINATOR	650		1998 → 2002	FDB2006			ST/P/EF	FDB2005			ST/SG/P/EF
SLR 650	650		1997 → 1998	FDB2006			ST/P/EF	FDB2005			ST/SG/P/EF
VIGOR 650	650		1999 → 2002	FDB2006			ST/P/EF	FDB2005			ST/SG/P/EF
XL 650 V TRANSALP	650		2000 →	FDB892	2		ZR/SG/P/EF/CPRO	FDB531			ST/P/EF
XR 650 L	650		1993 → 1995	FDB495			SG/P	FDB539			SG/P/EF
XR 650 L	650		1996 →	FDB892			ZR/SG/P/EF/CPRO	FDB539			SG/P/EF
XR 650 R	650		1999 →	FDB892			ZR/SG/P/EF/CPRO	FDB539			SG/P/EF
XR V 650 AFRICA TWIN (RD03)	650	37	1988 → 1990	FDB663			ST/P/EF	FDB531			ST/P/EF
DEAUVILLE TRAVEL	680		2007 →	FDB2196	2		ST/SM/P/EF	FDB2073			ST/SM/P/EF
DN-01 Sports Cruiser	680		2009 →	FDB2196	2		ST/SM/P/EF	FDB570			XRAC/ST/SM/P/EF/CPRO
NT 700 DEAUVILLE 680 / ABS	680		2006 →	FDB2196			ST/SM/P/EF	FDB2098			ST/P/EF
XL 700 V TRANSALP (ABS)	680	44	2007 →	FDB2196	2		ST/SM/P/EF	FDB754			ST/P/EF
XL 700 V TRANSALP (No ABS Front)	680	44	2007 →	FDB892	2		ZR/SG/P/EF/CPRO	FDB531			ST/P/EF
CB 700 SC NIGHT HAWK	700		1984 →	FDB244	2		ST/P/EF	FSB761			
CTX700	700		2014 →	FDB664			ST/P/EF	FDB2258			ST/EF
CTX700N	700		2014 →	FDB664			ST/P/EF	FDB2258			ST/EF
NC 700 D Integra (RC62)	700	35	2012 → 2013	FDB2196			ST/SM/P/EF	FDB754			ST/P/EF
NC 700 D Integra (RC62)	700	38	2012 → 2013	FDB2196			ST/SM/P/EF	FDB754			ST/P/EF
NC 700 S,X (man.gearbox - No ABS)	700		2012 →	FDB664			ST/P/EF	FDB531			ST/P/EF
NC 700 SA,XA (man.gearbox - ABS)	700		2012 →	FDB2196			ST/SM/P/EF	FDB754			ST/P/EF
NC 700 SD,XD (automatic gearbox - ABS)	700		2012 →	FDB2196			ST/SM/P/EF	FDB754			ST/P/EF

HONDA

* It is recommended that in those applications where sintered pads are supplied as Original Equipment, replacement pads should also be of sintered composition.

** To avoid brake imbalance sintered pads fitted in rear calipers should only be used in combination with front calipers containing sintered pads.



CC KW FROM -> TO N° SET L/R COMPOUND N° SET L/R COMPOUND

...HONDA

VF 700 C MAGNA	700	1984	→	FDB244	2		ST/P/EF	FSB711			
VF 700 F INTERCEPTOR	700	1984	→ 1985	FDB244	2		ST/P/EF	FDB538			P
VF 700 S SABRE	700	1984	→	FDB244	2		ST/P/EF	FSB711			
VF 700 C MAGNA	700	1985	→	FDB244	2		ST/P/EF	FSB761			
VFR 700 F/F2 INTERCEPTOR	700	1986	→ 1987	FDB452	2		ST/P	FDB538			P
VFR 700 F INTERCEPTOR	700	1988	→	FDB570	2		XRAC/ST/SM/P/EF/CPRO	FDB570			XRAC/ST/SM/P/EF/CPRO
VT 700 C SHADOW	700	1984	→ 1985					FSB711			
VT 700 C SHADOW	700	1986	→	FDB244	2		ST/P/EF	FSB761			
VT 700 C SHADOW	700	1987	→	FDB244	2		ST/P/EF	FSB761			
NC 750 X Travel Edition	745	40	2018	→	FDB664		ST/P/EF	FDB2258			ST/EF
X-ADV	745		2017	→	FDB2294	2	ST	FDB2258			ST/EF
B 750 EC - ED	750		1982	→	FDB244	2	ST/P/EF	FDB244			ST/P/EF
B 750 F2 - F2D	750		1982	→	FDB244	2	ST/P/EF	FDB244			ST/P/EF
750 BLACK WIDOW	750		2001	→	FDB664		ST/P/EF	FSB761			
CB 750 SC NIGHTHAWK	750		1982	→ 1983	FDB244	2	ST/P/EF	FSB710			
CB 750 NIGHTHAWK	750		1991	→	FDB664	2	ST/P/EF	FSB711			
CB 750 F - F1	750		1976	→ 1978	FDB119		P	FDB134			P
CB 750 F2 - F3	750		1977	→	FDB182	2	P	FDB182			P
CB 750 FZ	750		1979	→	FDB182	2	P	FDB182			P
CB 750 FA - FB - F2C	750		1980	→	FDB182	2	P				
CB 750 K1 - K6	750		1971	→ 1977				FSB710			
CB 750 K7 - K8	750		1978	→	FDB119		P	FSB710			
CB 750 KZ	750		1980	→	FDB183	2	P	FSB710			
CB 750 K	750		1982	→	FDB244	2	ST/P/EF	FDB244			ST/P/EF
CB 750 N SEVEN FIFTY	750		1992	→ 2002	FDB570	2	XRAC/ST/SM/P/EF/CPRO	FDB754			ST/P/EF
CBR 750 SUPER AERO	750		1988	→ 1989	FDB663	2	ST/P/EF	FDB858			ST/CP1
CBR 750 F HURRICANE	750		1987	→ 1988	FDB663	2	ST/P/EF	FDB538			P
CBR 750 F	750		1988	→	FDB570	2	XRAC/ST/SM/P/EF/CPRO	FDB570			XRAC/ST/SM/P/EF/CPRO
CBX 750 FE	750		1983	→ 1984	FDB244	2	ST/P/EF	FDB665			ST/P
MAGNA 750	750		1993	→	FDB570		XRAC/ST/SM/P/EF/CPRO	FSB761			
NC 750 D Integra (RC71)	750	40	2014	→ 2015	FDB570		XRAC/ST/SM/P/EF/CPRO	FDB2258			ST/EF
NC 750 D Integra (RC89)	750	40	2016	→	FDB570		XRAC/ST/SM/P/EF/CPRO	FDB2258			ST/EF
NC 750 S DCT	750		2014	→	FDB664		ST/P/EF	FDB2258			ST/EF
NC 750 X (RC72)	750	35	2014	→ 2015	FDB664		ST/P/EF	FDB2258			ST/EF
NC 750 X (RC72)	750	40	2014	→ 2015	FDB664		ST/P/EF	FDB2258			ST/EF
NC 750 X (RC90)	750	40	2016	→	FDB664		ST/P/EF	FDB2258			ST/EF
NM4 Vultus	750		2015	→	FDB570		XRAC/ST/SM/P/EF/CPRO	FDB2258			ST/EF
NR 750	750		1992	→	FDB533	2	XRAC/ST/P/CP1	FDB496			P
RVF 750 RR (RC 45)	750		1994	→	FDB858	2	ST/CP1	FDB496			P
VF 750 F-FD-FE-MAGNA-SABRE-INT	750		1982	→	FDB244	2	ST/P/EF	FDB665			ST/P
VF 750 C-SC-CC-F-FC	750		1983	→	FDB244	2	ST/P/EF	FSB711			
VF 750 CH	750		1987	→ 1989	FDB538	2	P	FSB711			
VF 750 C	750		1993	→	FDB570	2	XRAC/ST/SM/P/EF/CPRO	FSB711			
VFR 750 F INTERCEPTOR	750		1986	→ 1987	FDB663	2	ST/P/EF	FDB665			ST/P
VFR 750 C V45 MAGNA	750		1988	→	FDB538		P	FSB761			
VFR 750 F INTERCEPTOR	750		1988	→ 1989	FDB664	2	ST/P/EF	FDB664			ST/P/EF
VFR 750 R (RC-30)	750		1988	→ 1993	FDB533	2	XRAC/ST/P/CP1	FDB496			P
VFR 750 F	750		1990	→ 1993	FDB570	2	XRAC/ST/SM/P/EF/CPRO	FDB664			ST/P/EF
VFR 750 F	750		1994	→ 1997	FDB570	2	XRAC/ST/SM/P/EF/CPRO	FDB664			ST/P/EF
VT 750 C SHADOW	750		1983	→ 1985	FDB244		ST/P/EF	FSB711			
VT 750 C SHADOW	750		1986	→ 1996	FDB244		ST/P/EF	FSB761			
VT 750 C SHADOW	750		1997	→ 2009	FDB664		ST/P/EF	FSB761			
VT 750 AMERICAN CLASSIC EDITION	750		1998	→ 1998	FDB664		ST/P/EF	FSB761			
VT 750 DC Black Widow	750		2001	→ 2004	FDB664		ST/P/EF	FSB761			
VT 750 DC Shadow Spirit	750		2007	→ 2009	FDB664		ST/P/EF	FSB761			
VT 750 C2 SHADOW	750		2010	→ 2012	FDB2196		ST/SM/P/EF	FDB2111			ST/P/EF
VT 750 C2 SHADOW BLACK SPIRIT	750		2010	→	FDB664		ST/P/EF	FSB761			
VT 750 S	750		2010	→ 2012	FDB664		ST/P/EF	FSB761			
XLV 750 R - RD - RF	750		1984	→ 1988	FDB244		ST/P/EF	FSB755			
XRV 750 AFRICA TWIN (RD04)	750	37	1990	→ 1993	FDB462	2	ST/P	FDB531			ST/P/EF
XRV 750 AFRICA TWIN (RD04)	750	43	1990	→ 1993	FDB462	2	ST/P	FDB531			ST/P/EF
XRV 750 AFRICA TWIN (RD07)	750	37	1994	→ 2003	FDB892	2	ZR/SG/P/EF/CPRO	FDB531			ST/P/EF
XRV 750 AFRICA TWIN (RD07)	750	44	1994	→ 2003	FDB892	2	ZR/SG/P/EF/CPRO	FDB531			ST/P/EF
VFR 800 X Crossrunner (RC60)	780		2011	→ 2013	FDB2196	2	ST/SM/P/EF	FDB2253			ST
PC 800 PACIFIC COAST	800		1989	→ 1997	FDB570	2	XRAC/ST/SM/P/EF/CPRO	FSB761			
VFR 800 FI	800		1998	→	FDB2098	2	ST/P/EF	FDB2098			ST/P/EF
VFR 800 FI INTERCEPTOR / INTERCEPTOR ABS	800		2002	→ 2005	FDB2098	2	ST/P/EF	FDB2098			ST/P/EF
VFR 800	800		2006	→ 2013	FDB2196	2	ST/SM/P/EF	FDB2098			ST/P/EF
VFR 800 F	800		2014	→ 2017	FDB2181	2	XRAC/ST	FDB570			XRAC/ST/SM/P/EF/CPRO
VFR 800 F	800		2018	→	FDB2300	2	XRAC/ST				
VFR 800 XC Crossrunner	800		2012	→ 2014	FDB2196	2	ST/SM/P/EF	FDB2253			ST
VFR 800 X Crossrunner	800		2015	→	FDB2181	2	XRAC/ST	FDB2253			ST
VFR 800 X Crossrunner Travel Edition	800		2015	→	FDB2181	2	XRAC/ST	FDB2253			ST
VT 800 C	800		1988	→	FDB244		ST/P/EF	FSB761			

* It is recommended that in those applications where sintered pads are supplied as Original Equipment, replacement pads should also be of sintered composition.

** To avoid brake imbalance sintered pads fitted in rear calipers should only be used in combination with front calipers containing sintered pads.



CC KW FROM -> TO N° SET L/R COMPOUND N° SET L/R COMPOUND

...HONDA

CB 900 HORNET	900	2002	→	FDB533	2			XRAC/ST/P/CP1	FDB754			ST/P/EF
CB 900 F - FZ - FA	900	1979	→ 1981	FDB182	2			P	FDB182			P
CB 900 F2B - FB	900	1982	→ 1983	FDB244	2			ST/P/EF	FDB244			ST/P/EF
CB 900 FD - FC - F2C - F2D	900	1983	→ 1985	FDB244	2			ST/P/EF	FDB244			ST/P/EF
CBR 900 RR-FIREBLADE (SC28)	900	1992	→ 1995	FDB533	2			XRAC/ST/P/CP1	FDB754			ST/P/EF
CBR 900 RR-FIREBLADE (Japan)	900	1998	→ 2003	FDB2114	2			XRAC/ST/P	FDB754			ST/P/EF
CBR 900 RR-FIREBLADE (SC33)	900	1998	→ 1999	FDB2079	2			ZRAC/XRAC/ST/P/EF/CPRO/CP1	FDB754			ST/P/EF
CBR 900 RR-FIREBLADE (SC44&50)	900	2000	→ 2003	FDB2079	2			ZRAC/XRAC/ST/P/EF/CPRO/CP1	FDB754			ST/P/EF
CBR 929 RR-FIREBLADE	929	2000	→ 2001	FDB2079	2			ZRAC/XRAC/ST/P/EF/CPRO/CP1	FDB754			ST/P/EF
VFR 950 F CARAT	950	1992	→	FDB570	2			XRAC/ST/SM/P/EF/CPRO	FDB664			ST/P/EF
CB 1000 R plus	998	107	2018	→	FDB2300	2		XRAC/ST	FDB570			XRAC/ST/SM/P/EF/CPRO
CRF 1000 L AFRICA TWIN	998	70	2016	→	FDB2294	2		ST	FDB754			ST/P/EF
CRF 1000 L AFRICA TWIN Adventure Sport-DCT	998	70	2018	→	FDB2294	2		ST	FDB754			ST/P/EF
CB 1000 SUPERFOUR (BIG FOUR)	1000	1992	→	FDB570	2			XRAC/ST/SM/P/EF/CPRO	FDB664			ST/P/EF
CB 1000 R (No ABS)	1000	2009	→	FDB2181	2			XRAC/ST	FDB2253			ST
CB 1000 R	1000	107	2018	→	FDB2300	2		XRAC/ST	FDB570			XRAC/ST/SM/P/EF/CPRO
CB 1000 SF	1000	1993	→ 1997	FDB533	2			XRAC/ST/P/CP1	FDB754			ST/P/EF
CBF 1000	1000	2006	→	FDB570	2			XRAC/ST/SM/P/EF/CPRO	FDB754			ST/P/EF
CBF 1000 / Special Ed. (ABS System)	1000	2006	→	FDB2196	2			ST/SM/P/EF	FDB2196			ST/SM/P/EF
CBF 1000 F ABS	1000	2011	→	FDB2196	2			ST/SM/P/EF	FDB754			ST/P/EF
CBR 1000 BIG ONE	1000	1993	→ 1997	FDB533	2			XRAC/ST/P/CP1	FDB754			ST/P/EF
CBR 1000 FIREBLADE	1000	2004	→ 2005	FDB2181	2			XRAC/ST	FDB754			ST/P/EF
CBR 1000 FIREBLADE - Racing Applications	1000	2004	→ 2005	FDB2205	2			ZRAC/CPRO	FDB754			ST/P/EF
CBR 1000 RR	1000	2017	→	FDB2300	2			XRAC/ST				
CBR 1000 RR-R Fireblade SP	1000	2020	→	FDB2260	2			XRAC/ST/CPRO	FDB2074			ST/SM/P/EF/CPRO/AG
CBR 1000 F	1000	1987	→ 1988	FDB452	2			ST/P	FDB538			P
CBR 1000 F	1000	1989	→ 1992	FDB570	2			XRAC/ST/SM/P/EF/CPRO	FDB570			XRAC/ST/SM/P/EF/CPRO
CBR 1000 F-FP	1000	1993	→ 1999	FDB2002	2			ST/P	FDB2002			ST/P
CBR 1000 R HURRICANE	1000	1987	→ 1988	FDB452	2			ST/P	FDB538			P
CBR 1000 RR FIREBLADE / Hansspree Ed.	1000	2006	→ 2013	FDB2181	2			XRAC/ST	FDB2221			ST/P
CBR 1000 RR Fireblade	1000	141	2014	→	FDB2181	2		XRAC/ST	FDB2221			ST/P
CBR 1000 RR Fireblade SP	1000	141	2014	→	FDB2260	2		XRAC/ST/CPRO	FDB2221			ST/P
CBR 1000 RR Fireblade SP-1/SP2	1000	2017	→	FDB2260	2			XRAC/ST/CPRO	FDB2221			ST/P
CBX 1000	1000	1977	→ 1980	FDB182	2			P	FDB182			P
CBX 1000 B - C	1000	1981	→ 1982	FDB244	2			ST/P/EF	FDB244			ST/P/EF
GL 1000	1000	1981	→	FDB182	2			P	FDB182			P
GL 1000 K1 - 2 - 3	1000	1977	→ 1979	FDB182	2			P	FDB134			P
GL 1000 KZ	1000	1977	→ 1979	FDB182	2			P	FDB134			P
RCV 213	1000	2015	→	FDB2260	2			XRAC/ST/CPRO	FDB2074			ST/SM/P/EF/CPRO/AG
VF 1000 - 2	1000	1984	→ 1986	FDB244	2			ST/P/EF	FDB665			ST/P
VF 1000 BOL D'OR	1000	1984	→ 1986	FDB244	2			ST/P/EF	FDB665			ST/P
VF 1000 F - FE	1000	1984	→ 1986	FDB244	2			ST/P/EF	FDB665			ST/P
VF 1000 RE - RF	1000	1984	→ 1986	FDB244	2			ST/P/EF				
VTR 1000 FV FIRESTORM - SUPERHAWK	1000	1997	→ 2000	FDB533	2			XRAC/ST/P/CP1	FDB754			ST/P/EF
VTR 1000 SP-1 (Japan)	1000	2000	→ 2004	FDB2114	2			XRAC/ST/P	FDB754			ST/P/EF
VTR 1000 SP-1 (SC45)	1000	2000	→ 2001	FDB2079	2			ZRAC/XRAC/ST/P/EF/CPRO/CP1	FDB754			ST/P/EF
VTR 1000 SP-2 (SC45)	1000	2002	→	FDB2079	2			ZRAC/XRAC/ST/P/EF/CPRO/CP1	FDB754			ST/P/EF
XL 1000 V VARADERO	1000	1999	→ 2003	FDB2098	2			ST/P/EF	FDB2075			ST/SM/P/EF
XL 1000 VARADERO A4 (ABS)	1000	2004	→	FDB2196	2			ST/SM/P/EF	FDB2075			ST/SM/P/EF
CRF 1100L Africa Twin Adventure Sports	1100	75	2020	→					FDB754			ST/P/EF
CRF 1100L Africa Twin DCT	1100	75	2020	→					FDB754			ST/P/EF
1100 AMERICAN CLASSIC EDITION	1100	1995	→	FDB570				XRAC/ST/SM/P/EF/CPRO	FDB754			ST/P/EF
CB 1100 HORNET	1100	1999	→ 2000	FDB2098	2			ST/P/EF	FDB2073			ST/SM/P/EF
CB 1100	1100	2013	→	FDB2196	2			ST/SM/P/EF	FDB754			ST/P/EF
CB 1100	1100	2017	→						FDB754			ST/P/EF
CB 1100 EX	1100	2015	→	FDB2079	2			ZRAC/XRAC/ST/P/EF/CPRO/CP1	FDB754			ST/P/EF
CB 1100 FD	1100	1980	→ 1983	FDB244	2			ST/P/EF	FDB244			ST/P/EF
CB 1100 RBI - II	1100	1980	→ 1983	FDB244	2			ST/P/EF	FDB244			ST/P/EF
CB 1100 RC	1100	1980	→ 1983	FDB538	2			P	FDB538			P
CB 1100 RC ventilated discs	1100	1980	→ 1983	FDB538	2			P	FDB538			P
CB 1100 RCII	1100	1980	→ 1983	FDB244	2			ST/P/EF	FDB244			ST/P/EF
CB 1100 RS	1100	66	2017	→	FDB2300			XRAC/ST	FDB754			ST/P/EF
CBR 1100 XX Superblackbird	1100	1996	→ 1997	FDB2073	2			ST/SM/P/EF	FDB2075			ST/SM/P/EF
CBR 1100 XX Superblackbird	1100	1998	→	FDB2098	2			ST/P/EF	FDB2098			ST/P/EF
CBX 1100 F	1100	1982	→ 1985	FDB538	2			P	FDB244			ST/P/EF
GL 1100	1100	1980	→ 1981	FDB182	2			P	FDB182			P
GL 1100 / DX	1100	1982	→	FDB244	2			ST/P/EF	FDB244			ST/P/EF
ST 1100 PAN EUROPEAN	1100	1990	→ 2000	FDB570	2			XRAC/ST/SM/P/EF/CPRO	FDB570			XRAC/ST/SM/P/EF/CPRO
ST 1100 PAN EUROPEAN ABS/TCS	1100	1992	→ 1995	FDB570	2			XRAC/ST/SM/P/EF/CPRO	FDB570			XRAC/ST/SM/P/EF/CPRO
ST 1100 PAN EUROPEAN ABS/TCS (Dual brake)	1100	1996	→ 2000	FDB2098	2			ST/P/EF	FDB2075			ST/SM/P/EF
VT 1100 C MAGNA	1100	1983	→ 1985	FDB244	2			ST/P/EF	FDB244			ST/P/EF
VT 1100 C	1100	1985	→ 1993	FDB244				ST/P/EF	FSB761			
VT 1100 C SHADOW	1100	1994	→	FDB570				XRAC/ST/SM/P/EF/CPRO	FSB761			
VT 1100 C2 SHADOW	1100	1995	→	FDB570	2			XRAC/ST/SM/P/EF/CPRO	FDB754			ST/P/EF

* It is recommended that in those applications where sintered pads are supplied as Original Equipment, replacement pads should also be of sintered composition.

** To avoid brake imbalance sintered pads fitted in rear calipers should only be used in combination with front calipers containing sintered pads.



CC KW FROM -> TO N° SET L/R COMPOUND



N° SET L/R COMPOUND

...HONDA

X 11 1100	1100	2000	→ 2002	FDB2073	2		ST/SM/P/EF	FDB2075			ST/SM/P/EF
GL 1200 DX all models	1200	1984	→ 1986	FDB244	2		ST/P/EF	FDB244			ST/P/EF
VFR 1200 FA (Man.Trans.) SC63	1237	127	2009 →	FDB2259	2		ST	FDB2281			ST
VFR 1200 XA Crosstourer (Man.Trans.) SC70	1237	95	2012 →	FDB2196	2		ST/SM/P/EF	FDB2281			ST
VFR 1200 XD-DCT Crosstourer (Autom. Transm.) SC70	1237	95	2012 →	FDB2196	2		ST/SM/P/EF	FDB2281			ST
VFR 1200 X Crosstourer	1237		2016 →	FDB2196	2		ST/SM/P/EF	FDB2281			ST
CB 1300	1300		2001 →	FDB2079	2		ZRAC/XRAC/ST/P/EF/CPRO/CP1	FDB754			ST/P/EF
CB 1300 SF	1300		1998 → 2000	FDB2036	2		XRAC/ST/P	FDB2111			ST/P/EF
CB 1300 S	1300		2011 →	FDB2196	2		ST/SM/P/EF	FDB754			ST/P/EF
CB 1300 X4	1300		1997 → 2000	FDB533	2		XRAC/ST/P/CP1	FDB2111			ST/P/EF
CTX1300	1300		2014 →	FDB2196	2		ST/SM/P/EF	FDB2098			ST/P/EF
ST 1300 PAN EUROPEAN / ABS	1300		2002 →	FDB2098	2		ST/P/EF	FDB2098			ST/P/EF
ST 1300 PAN EUROPEAN / ABS	1300		2008 →	FDB2196	2		ST/SM/P/EF	FDB2098			ST/P/EF
VT 1300 CX	1300		2010 →	FDB664			ST/P/EF	FDB754			ST/P/EF
VTX 1300 S / C	1300		2003 →	FDB570			XRAC/ST/SM/P/EF/CPRO	FDB754			ST/P/EF
GL 1520	1500		1988 → 1989	FDB665	2		ST/P	FDB244			ST/P/EF
GL 1520 / 6 GOLD WING	1500		1988 → 1991	FDB663	2		ST/P/EF	FDB665			ST/P
GL 1500 GOLD-ASPENCADE	1500		1992 →	FDB663	2		ST/P/EF	FDB244			ST/P/EF
GL 1500 FC6	1500		1997 → 1999	FDB570	2		XRAC/ST/SM/P/EF/CPRO	FDB570			XRAC/ST/SM/P/EF/CPRO
GL 1500 SE GOLD WING	1500		1993 → 2000	FDB663	2		ST/P/EF	FDB244			ST/P/EF
GL 1800 GOLDWING	1800		2001 →	FDB2098	2		ST/P/EF	FDB2098			ST/P/EF
VTX 1800	1800		2001 →	FDB2098	2		ST/P/EF	FDB2098			ST/P/EF
GOLDWING F6B	1832		2012 →	FDB2098	2		ST/P/EF	FDB2075			ST/SM/P/EF
GOLDWING F6C	1832		2014 →	FDB2114	2		XRAC/ST/P	FDB2075			ST/SM/P/EF
GL 1800 Gold Wing	1833		2019 →					FDB2075			ST/SM/P/EF
GL 1800 Gold Wing Tour	1833	93	2019 →					FDB2075			ST/SM/P/EF

HONDA-HM ITALIA

CRE 50 (from frame nr.2819)	50		→	FDB677			P/EF	FDB828			ST/P
CRE 50 (up to frame nr.1000)	50		→	FDB499			P	FDB475			AG
CRE 50	50		2006 →	FDB677			P/EF	FDB2128			EF
CRE 50 SIX Comp.	50		2007 → 2012	FDB2268			P	FDB2162			SG/P/EF
CRE 50 Baja	50		2011 →	FDB497			ST/SM/SG/P/EF	FDB828			ST/P
CRE 50 Six Racing	50		2011 →	FDB892			ZR/SG/P/EF/CPRO	FDB2162			SG/P/EF
CRM 50 Derapage Comp.	50		2007 → 2012	FDB2268			P	FDB2162			SG/P/EF
CRM 50 Derapage	50		2011 →	FDB497			ST/SM/SG/P/EF	FDB828			ST/P
CB 125	125		1979 →					FSB704			
CRE 125 2T /Six Comp	125		2002 →	FDB892			ZR/SG/P/EF/CPRO	FDB2139			SG/P/EF
CRE 125 SIX Comp.	125		2010 → 2011	FDB2268			P	FDB2162			SG/P/EF
CRE 125 4T Six Racing	125		2011 →	FDB892			ZR/SG/P/EF/CPRO	FDB2162			SG/P/EF
CRE Baja HM 125 4T	125		2011 →	FDB497			ST/SM/SG/P/EF	FDB828			ST/P
CRE Baja RR HM 125 2T	125		2011 →	FDB2242			P/EF	FDB2139			SG/P/EF
CRE Baja RR HM 125 4T	125		2011 →	FDB2167			XRAC/CP1	FDB828			ST/P
CRM 125 2T Derapage Comp.	125		2011 → 2012	FDB2268			P	FDB2162			SG/P/EF
CRM 125 4T Derapage Comp.	125		2011 → 2012	FDB2268			P	FDB2162			SG/P/EF
CRM 125 4T Derapage HM	125		2011 →	FDB497			ST/SM/SG/P/EF	FDB828			ST/P
DT 125	125		1987 →	FDB438			P/EF	FSB704			
MTX 125 R	125		1986 →	FDB438			P/EF	FSB704			
MTX 125 RALLY SPORT	125		1988 →	FDB438			P/EF	FDB704			
NS 125 F	125		1985 →	FDB438			P/EF	FSB704			
NS 125 R SUPER SPORT	125		1987 →	FDB438	2		P/EF	FSB704			
NSR 125 R	125		1989 →	FDB438			P/EF	FRP416			P
XL 125	125		1979 →	FSB704				FSB704			
XL 125 PARIS DAKAR	125		1984 → 1985	FSB704				FSB704			
XL 125 L PARIS DAKAR	125		1985 →	FDB438			P/EF	FSB704			
XL 125 R2	125		1987 →	FDB438			P/EF	FSB704			
XL 200 R	200		1983 →	FSB704				FSB704			
XL 200 R PARIS DAKAR	200		1984 →	FSB704				FSB704			
XL 200 L	200		1985 →	FDB438			P/EF	FSB704			
XL 200 L PARIS DAKAR	200		1987 →	FDB438			P/EF	FSB704			
XL 200 R2	200		1987 →	FDB438			P/EF	FSB704			
CRE 250 / CRE F250 X/R	250		2002 →	FDB892			ZR/SG/P/EF/CPRO	FDB2139			SG/P/EF
CRE 260	260		1990 →	FDB495			SG/P	FDB539			SG/P/EF
CRE F300 X	300		2008 →	FDB892			ZR/SG/P/EF/CPRO	FDB2139			SG/P/EF
CRE F450 X/R	450		2008 →	FDB892			ZR/SG/P/EF/CPRO	FDB2139			SG/P/EF
CRE F450 R	450		2011 →	FDB892			ZR/SG/P/EF/CPRO	FDB2139			SG/P/EF
CRM F 450 R	450		2008 →	FDB2244			ST	FDB2139			SG/P/EF
CRM F 450 X	450		2008 →	FDB2244			ST	FDB2139			SG/P/EF
CRE F500 X	500		2009 →	FDB892			ZR/SG/P/EF/CPRO	FDB2139			SG/P/EF

* It is recommended that in those applications where sintered pads are supplied as Original Equipment, replacement pads should also be of sintered composition.

** To avoid brake imbalance sintered pads fitted in rear calipers should only be used in combination with front calipers containing sintered pads.



CC KW FROM -> TO



N° SET L/R COMPOUND



N° SET L/R COMPOUND

HOREX

REBELL 80 N	80	→	FDB213			P			
REBELL 80 SPORTL	80	→	FDB213	2		P			
REBELL 80 T	80	→	FDB213	2		P			

HRD

FORMULA 125 LS	125	1986 →	FDB694			ST/AG	FDB694		ST/AG
PLATINO 125 SL	125	1986 →	FDB694			ST/AG	FDB694		ST/AG
PLATINO 125 ST	125	1986 →	FDB207			ST/P/EF/CP1			
ROAD 125 ST	125	1986 →	FDB207			ST/P/EF/CP1			
SILVER 125 HOUSE	125	1986 →	FDB694			ST/AG	FDB694		ST/AG

HSC

HSC 01 50	50	1992 →	FDB625			EF	FSB714		
SR 50 DIO	50	1992 →	FDB625			EF	FSB714		
ZR 50	50	1992 →	FDB625			EF	FSB714		
ZX 50 DIO	50	1992 →	FDB625			EF	FSB714		

HUSABERG

FE 350 / 450 / 550 / 650 / E	350	1995 →	FDB2018			ZR/ST/SG/P/EF	FDB2005		ST/SG/P/EF
MC 350	350	1991 → 1993	FDB499			P	FDB314		ST/SG/P/EF
MC 350	350	1994 →	FDB499			P	FDB2005		ST/SG/P/EF
FC 400	400	1999 →	FDB2018			ZR/ST/SG/P/EF	FDB2005		ST/SG/P/EF
FE 400 S - E	400	1998 →	FDB2018			ZR/ST/SG/P/EF	FDB2005		ST/SG/P/EF
FE 450	450	2003 → 2006	FDB2018			ZR/ST/SG/P/EF	FDB2005		ST/SG/P/EF
FE 450 c	450	2006 →	FDB2245			ST	FDB2005		ST/SG/P/EF
500 all models	500	1991 → 1992	FDB499			P	FDB314		ST/SG/P/EF
500 all models	500	1993 → 1995	FDB2018			ZR/ST/SG/P/EF	FDB314		ST/SG/P/EF
500 all models	500	1996 →	FDB2018			ZR/ST/SG/P/EF	FDB2005		ST/SG/P/EF
501 ENDURO	500	1992 → 1993	FDB499			P	FDB314		ST/SG/P/EF
FC 501	500	1998 →	FDB2018			ZR/ST/SG/P/EF	FDB2005		ST/SG/P/EF
FE 501 S - E	500	1998 →	FDB2018			ZR/ST/SG/P/EF	FDB2005		ST/SG/P/EF
FC 350 / 450 / 550	550	1995 →	FDB2018			ZR/ST/SG/P/EF	FDB2005		ST/SG/P/EF
FE 550 E Strada	550	2008 →	FDB2018			ZR/ST/SG/P/EF	FDB2005		ST/SG/P/EF
FE 570	570	2009 →	FDB2018			ZR/ST/SG/P/EF	FDB2005		ST/SG/P/EF
EF 600 E (Quad)	600	1998 →	FDB2005			ST/SG/P/EF	FDB314		ST/SG/P/EF
600 ENDURO	600	1992 → 1993	FDB499			P	FDB314		ST/SG/P/EF
FC 600 SUPERMOTARD	600	1998 →	FDB2018			ZR/ST/SG/P/EF	FDB2005		ST/SG/P/EF
FE 600 S - E - R	600	1998 →	FDB2018			ZR/ST/SG/P/EF	FDB2005		ST/SG/P/EF
FE 600 SUPERMOTARD	600	2000 → 2007	FRP408			XRAC/ST/PRP/P/CPRO/CP1	FDB2005		ST/SG/P/EF
FE 650 E	650	2006 → 2008	FDB2018			ZR/ST/SG/P/EF	FDB2005		ST/SG/P/EF
FS 650 e, c	650	2006 →	FDB2245			ST	FDB2005		ST/SG/P/EF

HUSQVARNA

CR 50 Junior	50	2005 →	FDB2127			SG			
CR 50 Senior Pro	50	2005 →	FDB2127			SG	FDB2183		SG
CR 50	50	2010 → 2013	FDB2183			SG	FDB2183		SG
SM 50	50	2010 → 2013	FDB2183			SG	FDB2183		SG
TC 50	50	2017 →	FDB2183			SG	FDB2183		SG
WRS 50 (SCOOTER)	50	1998 → 2000	FRP405			ST/SG/PRP/P/EF	FSB704		
CR 65	65	2010 → 2013	FDB2157			SG	FDB2257		SG
TC65	65	2017 →	FDB2157			SG	FDB2157		SG
TC 85 (2T/ 17"/14" Wheels)	85	2014 →	FDB2262			SG	FDB2257		SG
TC 85 (2T/ 19"/16" Wheels)	85	2014 →	FDB2262			SG	FDB2257		SG
TE 100	100	2005 →	FDB2127			SG			
125 ALL MODELS 1992	125	1992 → 1992	FDB497			ST/SM/SG/P/EF	FDB250		SG/P/EF
125 ALL MODELS 1993	125	1993 → 1993	FDB497			ST/SM/SG/P/EF	FDB661		SG/P
125 ALL MODELS 1994-1995	125	1994 → 1995	FDB2018			ZR/ST/SG/P/EF	FDB2005		ST/SG/P/EF
CR 125	125	1981 → 1982	FSB850				FSB850		
CR 125	125	1983 → 1984	FSB812				FSB850		
CR 125	125	1985 → 1995	FDB207			ST/P/EF/CP1	FSB812		
CR 125 CROSS	125	1991 → 1995	FDB499			P	FDB314		ST/SG/P/EF
CR 125	125	1996 → 2004	FDB2018			ZR/ST/SG/P/EF	FDB2005		ST/SG/P/EF
CR 125	125	2005 → 2013	FDB2018			ZR/ST/SG/P/EF	FDB2165		SG/P/EF
RC 125	125	1981 → 1982	FSB850				FSB850		
RC 125	125	1983 → 1984	FSB812				FSB850		
SM 125 S SUPERMOTARD	125	1998 → 1999	FDB2018			ZR/ST/SG/P/EF	FDB2005		ST/SG/P/EF
SM 125 S	125	2002 → 2011	FDB2018			ZR/ST/SG/P/EF	FDB2005		ST/SG/P/EF

* It is recommended that in those applications where sintered pads are supplied as Original Equipment, replacement pads should also be of sintered composition.

** To avoid brake imbalance sintered pads fitted in rear calipers should only be used in combination with front calipers containing sintered pads.



	CC	KW	FROM -> TO		N° SET	L/R	COMPOUND		N° SET	L/R	COMPOUND
...HUSQVARNA											
SM 125 S (4T)	125		2011 →	FDB2018			ZR/ST/SG/P/EF	FDB2005			ST/SG/P/EF
TC 125 (2T)	125		2014 →	FDB2018			ZR/ST/SG/P/EF	FDB2165			SG/P/EF
TE 125	125		2007 → 2010	FDB2018			ZR/ST/SG/P/EF	FDB539			SG/P/EF
TE 125 (4T)	125		2011 → 2013	FDB2018			ZR/ST/SG/P/EF	FDB2005			ST/SG/P/EF
TE 125 (2T)	125		2014 →	FDB2018			ZR/ST/SG/P/EF	FDB2165			SG/P/EF
TX 125	125		2018 →	FDB2018			ZR/ST/SG/P/EF	FDB2165			SG/P/EF
WR 125	125		1983 → 1985	FSB813				FSB850			
WR 125	125		1986 → 1986	FDB207			ST/P/EF/CP1	FSB812			
WR 125	125		1987 → 1990	FDB499			P	FSB812			
WR 125	125		1991 → 1997	FDB499			P	FDB314			ST/SG/P/EF
WR 125	125		1998 → 2005	FDB2018			ZR/ST/SG/P/EF	FDB2005			ST/SG/P/EF
WR 125	125		2006 → 2013	FDB2018			ZR/ST/SG/P/EF	FDB2165			SG/P/EF
ENDURO WR 125	125		2010 →	FDB2018			ZR/ST/SG/P/EF	FDB2165			SG/P/EF
WRE 125	125		1983 → 1984	FSB813				FSB850			
WRE 125	125		1988 →	FDB499			P	FSB812			
WRE 125	125		1989 → 1994	FDB499			P				
WRE 125 / DUAL	125		1994 → 1999	FDB2018			ZR/ST/SG/P/EF	FDB2005			ST/SG/P/EF
WRE 125	125		2000 → 2013	FDB2018			ZR/ST/SG/P/EF	FDB2165			SG/P/EF
WXE 125	125		2007 →	FDB706			P	FDB539			SG/P/EF
CR 240	240		1981 → 1982	FSB812				FSB850			
CR 240	240		1983 → 1986	FSB813				FSB850			
CR 240	240		1987 →	FDB499			P	FSB812			
RC 240	240		1981 → 1982	FSB812				FSB850			
RC 240	240		1983 →	FSB813				FSB850			
WR 240	240		1983 → 1984	FSB813				FSB850			
WR 240	240		1985 →	FSB813				FSB812			
WR 240	240		1986 →	FDB207			ST/P/EF/CP1	FSB812			
WR 240	240		1987 → 1990	FDB499			P	FSB812			
WR 240	240		1991 →	FDB499			P	FDB314			ST/SG/P/EF
WRE 240	240		1983 →	FSB813				FSB850			
WRK 240	240		1988 →	FDB499			P	FSB812			
250 ALL MODELS 1992	250		1992 → 1992	FDB497			ST/SM/SG/P/EF	FDB250			SG/P/EF
250 ALL MODELS 1993	250		1993 → 1993	FDB497			ST/SM/SG/P/EF	FDB661			SG/P
250 ALL MODELS 1994-1995	250		1994 → 1995	FDB2018			ZR/ST/SG/P/EF	FDB2005			ST/SG/P/EF
CR 250	250		1981 → 1982	FSB812				FSB850			
CR 250	250		1983 → 1984	FSB813				FSB850			
CR 250	250		1985 → 1995	FDB207			ST/P/EF/CP1	FSB812			
CR 250 CROSS	250		1991 → 1995	FDB499			P	FDB314			ST/SG/P/EF
CR 250	250		1996 →	FDB2018			ZR/ST/SG/P/EF	FDB2005			ST/SG/P/EF
CR 250	250		2005 → 2007	FDB2018			ZR/ST/SG/P/EF	FDB2165			SG/P/EF
FC 250 (4T)	250		2014 →	FDB2018			ZR/ST/SG/P/EF	FDB2165			SG/P/EF
FE 250 (4T)	250		2014 →	FDB2018			ZR/ST/SG/P/EF	FDB2165			SG/P/EF
RC 250	250		1981 → 1982	FSB812				FSB850			
RC 250	250		1983 →	FSB813				FSB850			
SMS 250	250		2011 →	FDB2018			ZR/ST/SG/P/EF	FDB2005			ST/SG/P/EF
TC 250	250		2002 → 2003	FDB2018			ZR/ST/SG/P/EF	FDB2005			ST/SG/P/EF
TC 250	250		2005 → 2008	FDB2018			ZR/ST/SG/P/EF	FDB2165			SG/P/EF
TC 250 (4T)	250		2009 → 2013	FDB2018			ZR/ST/SG/P/EF	FDB2165			SG/P/EF
TC 250 R	250		2013 →	FDB2018			ZR/ST/SG/P/EF	FDB2165			SG/P/EF
TC 250 (2T)	250		2014 →	FDB2018			ZR/ST/SG/P/EF	FDB2165			SG/P/EF
TE 250 (4T)	250		2002 → 2005	FDB2018			ZR/ST/SG/P/EF	FDB2005			ST/SG/P/EF
TE 250 (4T)	250		2006 → 2013	FDB2018			ZR/ST/SG/P/EF	FDB2165			SG/P/EF
TE 250 Meo Replica (4T)	250		2011 → 2011	FDB2018			ZR/ST/SG/P/EF	FDB2165			SG/P/EF
TE 250 R (4T)	250		2013 →	FDB2018			ZR/ST/SG/P/EF	FDB2165			SG/P/EF
TE 250 (2T)	250		2014 →	FDB2018			ZR/ST/SG/P/EF	FDB2165			SG/P/EF
WR 250	250		1983 → 1986	FSB813				FSB850			
WR 250	250		1987 → 1989	FDB499			P	FSB812			
WR 250	250		1990 → 1991	FDB499			P	FDB314			ST/SG/P/EF
WR 250	250		1992 → 1994	FDB499			P	FDB381			SG/P/EF
WR 250	250		1995 → 2008	FDB2018			ZR/ST/SG/P/EF	FDB2005			ST/SG/P/EF
WR 250 (2T)	250		2009 → 2013	FDB2018			ZR/ST/SG/P/EF	FDB2005			ST/SG/P/EF
WRE 250	250		1983 →	FSB813				FSB850			
XC 250	250		1987 →	FDB499			P	FSB812			
WR 260	260		1991 →	FDB499			P	FDB314			ST/SG/P/EF
WRK 260	260		1988 →	FDB499			P	FSB812			
TE 300 (2T)	300		2014 →	FDB2018			ZR/ST/SG/P/EF	FDB2165			SG/P/EF
WR 300 (2T)	300		2009 → 2013	FDB2018			ZR/ST/SG/P/EF	FDB2005			ST/SG/P/EF
TE 310	310		2010 → 2013	FDB2018			ZR/ST/SG/P/EF	FDB2165			SG/P/EF
TE 310 R (4T)	310		2013 →	FDB2018			ZR/ST/SG/P/EF	FDB2165			SG/P/EF
FC 350 (4T)	350		2014 →	FDB2018			ZR/ST/SG/P/EF	FDB2165			SG/P/EF
FE 350 (4T)	350		2015 →	FDB2018			ZR/ST/SG/P/EF	FDB2165			SG/P/EF
TE 350	350		1990 → 1995	FDB499			P	FDB314			ST/SG/P/EF
TE 350	350		1996 →	FDB2018			ZR/ST/SG/P/EF	FDB2005			ST/SG/P/EF
WR 360 ENDURO	360		1998 → 1999	FDB2018			ZR/ST/SG/P/EF	FDB2005			ST/SG/P/EF

* It is recommended that in those applications where sintered pads are supplied as Original Equipment, replacement pads should also be of sintered composition.

** To avoid brake imbalance sintered pads fitted in rear calipers should only be used in combination with front calipers containing sintered pads.



CC KW FROM -> TO N° SET L/R COMPOUND N° SET L/R COMPOUND

...HUSQVARNA

RC 390	390	1978 → 1980	FSB850				FSB850			
TE 400 E DUAL - ENDURO	400	1998 →	FDB2018			ZR/ST/SG/P/EF	FDB2005			ST/SG/P/EF
WR 400	400	1985 →	FSB813				FSB812			
WR 400	400	1986 →	FDB207			ST/P/EF/CP1	FSB812			
WR 400	400	1987 →	FDB499			P	FSB812			
401 SVARTPILEN	401	2015 →	FDB2266			ST/EF	FDB2005			ST/SG/P/EF
401 VITPILEN	401	2015 →	FDB2266			ST/EF	FDB2005			ST/SG/P/EF
Vitpilen 401 Aero	401	2017 →	FDB2266			ST/EF	FDB2005			ST/SG/P/EF
Vitpilen 401 TA	401	2017 →	FDB2266			ST/EF	FDB2005			ST/SG/P/EF
TE 410 E	410	2000 →	FDB2018			ZR/ST/SG/P/EF	FDB2005			ST/SG/P/EF
AE 430	430	1988 →	FDB499			P	FSB812			
AUTO 430	430	1987 →	FDB499			P	FSB812			
CR 430	430	1981 → 1982	FSB812				FSB850			
CR 430	430	1987 →	FDB499			P	FSB812			
OR 430	430	1981 → 1982	FSB812				FSB850			
RC 430	430	1981 → 1982	FSB812				FSB850			
WR 430	430	1981 → 1982	FSB812				FSB850			
WR AE 430	430	1987 →	FDB499			P	FSB812			
WRE 430	430	1981 → 1982	FSB812				FSB850			
XC 430	430	1981 → 1982	FSB812				FSB850			
XC 430	430	1987 →	FDB499			P	FSB812			
SMR 449 (4T)	449	2011 →	FDB2120			ZRAC/XRAC/ST	FDB2165			SG/P/EF
TC 449	449	2011 → 2013	FDB2018			ZR/ST/SG/P/EF	FDB2165			SG/P/EF
TE 449	449	2011 → 2013	FDB2018			ZR/ST/SG/P/EF	FDB2165			SG/P/EF
FC 450 (4T)	450	2014 →	FDB2018			ZR/ST/SG/P/EF	FDB2165			SG/P/EF
FE 450 (4T)	450	2014 →	FDB2018			ZR/ST/SG/P/EF	FDB2165			SG/P/EF
FS 450	450	2015 →	FDB2260			XRAC/ST/CPRO	FDB2165			SG/P/EF
SM 450 R	450	2003 → 2006	FRP408			XRAC/ST/PRP/CPRO/CP1	FDB2005			ST/SG/P/EF
SM 450 RR (Radial Caliper)	450	2006 → 2007	FDB2120			ZRAC/XRAC/ST	FDB2165			SG/P/EF
SM 450 R Radial caliper	450	2007 → 2010	FDB2120			ZRAC/XRAC/ST	FDB2165			SG/P/EF
SM 450 RR	450	2008 → 2010	FDB2120			ZRAC/XRAC/ST	FDB2165			SG/P/EF
TC 450	450	2003 → 2004	FDB2018			ZR/ST/SG/P/EF	FDB2005			ST/SG/P/EF
TC 450	450	2005 → 2010	FDB2018			ZR/ST/SG/P/EF	FDB2165			SG/P/EF
TE 450	450	2003 → 2005	FDB2018			ZR/ST/SG/P/EF	FDB2005			ST/SG/P/EF
TE 450	450	2006 → 2008	FDB2018			ZR/ST/SG/P/EF	FDB2165			SG/P/EF
TE 450 (4T)	450	2009 → 2010	FDB2018			ZR/ST/SG/P/EF	FDB2165			SG/P/EF
CR 490	490	1983 →	FSB813				FSB850			
AE 500	500	1984 →	FSB813				FSB850			
CR 500	500	1985 →	FDB207			ST/P/EF/CP1	FSB812			
TC 500	500	1984 →	FSB813				FSB850			
XC 500	500	1987 →	FDB499			P	FSB812			
FE 501 (4T)	501	2014 →	FDB2018			ZR/ST/SG/P/EF	FDB2165			SG/P/EF
510	510	1986 →	FDB207			ST/P/EF/CP1	FSB812			
SM 510 R	510	2005 → 2005	FRP408			XRAC/ST/PRP/CPRO/CP1	FDB2005			ST/SG/P/EF
SM 510 R (Radial caliper)	510	2006 → 2010	FDB2120			ZRAC/XRAC/ST	FDB2165			SG/P/EF
TC 510	510	1988 →	FDB499			P	FSB812			
TC 510	510	2004 → 2004	FDB2018			ZR/ST/SG/P/EF	FDB2005			ST/SG/P/EF
TC 510	510	2005 → 2009	FDB2018			ZR/ST/SG/P/EF	FDB2165			SG/P/EF
TE 510	510	1984 → 1987	FSB813				FSB850			
TE - AC - LC 510	510	1987 →	FDB499			P	FSB812			
TE 510	510	1988 → 1990	FDB499			P	FDB314			ST/SG/P/EF
TE 510	510	2002 → 2005	FDB2018			ZR/ST/SG/P/EF	FDB2005			ST/SG/P/EF
TE 510	510	2006 → 2010	FDB2018			ZR/ST/SG/P/EF	FDB2165			SG/P/EF
TX 510	510	1984 →	FSB813				FSB850			
SMR 511	511	2011 → 2013	FDB2120			ZRAC/XRAC/ST	FDB2165			SG/P/EF
TE 511 (4T)	511	2011 → 2012	FDB2018			ZR/ST/SG/P/EF	FDB2165			SG/P/EF
SM 530 RR	530	2008 → 2010	FDB2120			ZRAC/XRAC/ST	FDB2165			SG/P/EF
SM 570 R	570	→ 2004	FRP408			XRAC/ST/PRP/CPRO/CP1	FDB2005			ST/SG/P/EF
TE 570	570	→ 2004	FDB2018			ZR/ST/SG/P/EF	FDB2005			ST/SG/P/EF
LT 600 DUAL	600	1998 →	FDB2042			ZRAC/XRAC/ST/P/EF/CPRO	FDB2018			ZR/ST/SG/P/EF
SM 600 SUPERMOTARD	600	1998 →	FDB2042			ZRAC/XRAC/ST/P/EF/CPRO	FDB2005			ST/SG/P/EF
TE 600	600	1996 →	FDB2018			ZR/ST/SG/P/EF	FDB2005			ST/SG/P/EF
TE 600 E DUAL - ENDURO	600	1998 →	FDB2018			ZR/ST/SG/P/EF	FDB2005			ST/SG/P/EF
WRK 600	600	1989 →	FDB499			P				
LT 610	610	2000 → 2000	FDB2042			ZRAC/XRAC/ST/P/EF/CPRO	FDB2005			ST/SG/P/EF
SM 610 (6 bolt front disc)	610	1998 → 1999	FDB2042			ZRAC/XRAC/ST/P/EF/CPRO	FDB2005			ST/SG/P/EF
SM 610 R	610	2000 → 2011	FDB2042			ZRAC/XRAC/ST/P/EF/CPRO	FDB2005			ST/SG/P/EF
SM 610/S (4 bolt front disc)	610	2002 → 2006	FDB2042			ZRAC/XRAC/ST/P/EF/CPRO	FDB2005			ST/SG/P/EF
SM 610 S (Radial caliper)	610	2006 → 2006	FDB2120			ZRAC/XRAC/ST	FDB2005			ST/SG/P/EF
SM 610 IE	610	2007 → 2009	FDB2120			ZRAC/XRAC/ST	FDB2005			ST/SG/P/EF
TC 610 CROSS	610	1991 →	FDB497			ST/SM/SG/P/EF	FDB250			SG/P/EF
TC 610	610	1996 →	FDB2018			ZR/ST/SG/P/EF	FDB2005			ST/SG/P/EF
TE 610	610	1991 →	FDB497			ST/SM/SG/P/EF	FDB250			SG/P/EF
TE 610 E	610	1995 → 2000	FDB2018			ZR/ST/SG/P/EF	FDB2005			ST/SG/P/EF

* It is recommended that in those applications where sintered pads are supplied as Original Equipment, replacement pads should also be of sintered composition.

** To avoid brake imbalance sintered pads fitted in rear calipers should only be used in combination with front calipers containing sintered pads.



CC KW FROM -> TO N° SET L/R COMPOUND



N° SET L/R COMPOUND

...HUSQVARNA

TE 610 E	610	2003 → 2004	FDB2018			ZR/ST/SG/P/EF	FDB2005			ST/SG/P/EF
TE 610/IE	610	2006 → 2009	FDB2018			ZR/ST/SG/P/EF	FDB2005			ST/SG/P/EF
SMR 630	630	→ 2006	FRP408			XRAC/ST/PRP/PCPRO/CP1	FDB2005			ST/SG/P/EF
SMR 630 (4T)	630	2010 → 2012	FDB2120			ZRAC/XRAC/ST	FDB2005			ST/SG/P/EF
STR 650 CRC	630	2007 →	FDB2120			ZRAC/XRAC/ST	FDB2005			ST/SG/P/EF
TE 630	630	2010 → 2012	FDB2018			ZR/ST/SG/P/EF	FDB2005			ST/SG/P/EF
BAJA	650	2013 →	FDB2006			ST/P/EF	FDB2005			ST/SG/P/EF
Moab	650	2012 →	FDB2006			ST/P/EF	FDB2005			ST/SG/P/EF
SMR 650	650	2007 →	FDB2123			XRAC/CPRO	FDB2005			ST/SG/P/EF
STR 650	650	2007 →	FDB2120			ZRAC/XRAC/ST	FDB2005			ST/SG/P/EF
TR 650 Strada (Cast Wheel)	650	2012 → 2013	FDB2006			ST/P/EF	FDB2005			ST/SG/P/EF
TR 650 Terra (Spoke Wheel)	650	2012 → 2013	FDB2006			ST/P/EF	FDB2005			ST/SG/P/EF
701 SUPERMOTO	690	2015 →	FDB2120			ZRAC/XRAC/ST	FDB2005			ST/SG/P/EF
701 ENDURO	693	2018 →					FDB2005			ST/SG/P/EF
Svartpilen 701	701	2019 →	FDB2042			ZRAC/XRAC/ST/P/EF/CPRO	FDB2005			ST/SG/P/EF
701 VITPILEN	701	2016 →	FDB2260	2		XRAC/ST/CPRO	FDB2005			ST/SG/P/EF
NUDA 900	900	2012 →	FDB2260	2		XRAC/ST/CPRO	FDB2005			ST/SG/P/EF
NUDA 900 R	900	2012 →	FDB2042	2		ZRAC/XRAC/ST/P/EF/CPRO	FDB2005			ST/SG/P/EF
NUDA 900 ABS	900	2013 →	FDB2260	2		XRAC/ST/CPRO	FDB2005			ST/SG/P/EF
NUDA 900 R ABS	900	2013 →	FDB2042	2		ZRAC/XRAC/ST/P/EF/CPRO	FDB2005			ST/SG/P/EF

HYOSUNG

Electric GEM 4.0		2010 →	FDB631			ST/SM/SG/P/EF/AG	FDB631			ST/SM/SG/P/EF/AG
AVANTI 50	50	1999 →	FDB313			SG/P/EF				
RUSH 50	50	1997 →	FDB313			SG/P/EF				
SENSE 50	50	1998 →	FDB313			SG/P/EF				
SF 50 / RALLY / RACING	50	1999 →	FDB313			SG/P/EF				
SUPER CAB 50	50	1995 → 1997	FDB313			SG/P/EF				
SUPER CAB 50 PLUS	50	1998 →	FDB313			SG/P/EF				
CAB 100	100	1998 →	FDB313			SG/P/EF				
KR 110 MASTER	110	2004 →	FDB313			SG/P/EF	FSB722			
MIDAS 110 PLUS	110	1998 →	FDB313			SG/P/EF				
COMET 125	125	2004 →	FDB312			ST/P/EF	FDB312			ST/P/EF
GRAND PRIX 125	125	1998 →	FDB680			ST/EF				
GT 125 Naked	125	2004 →	FDB312			ST/P/EF	FDB312			ST/P/EF
GT 125 R	125	2006 →	FDB312			ST/P/EF	FDB312			ST/P/EF
GT 125 RC	125	2016 →	FDB312			ST/P/EF	FDB312			ST/P/EF
GV 125 AQUILA	125	2001 →	FDB312			ST/P/EF	FSB776			
GV 125	125	2005 →	FDB312			ST/P/EF	FSB776			
HYPER 125	125	1999 →	FDB680			ST/EF				
KE 125-2	125	2016 →	FDB313			SG/P/EF				
MS3 125	125	2006 →	FDB497		left	ST/SM/SG/P/EF				
MS3 125	125	2006 →	FDB631		right	ST/SM/SG/P/EF/AG				
MS3 125	125	2006 →					FDB631			ST/SM/SG/P/EF/AG
RT 125 KARION	125	2002 → 2006	FDB312			ST/P/EF	FSB776			
RT 125 D KARION	125	2007 →	FDB312			ST/P/EF	FSB776			
RX 125	125	2001 → 2007	FDB312			ST/P/EF	FSB721			
RX 125 SM	125	2007 →	FDB312			ST/P/EF	FDB312			ST/P/EF
V2 125	125	1999 →	FDB570			XRAC/ST/SM/P/EF/CPRO				
XRX 125 OFFROAD	125	1999 →	FDB312			ST/P/EF	FSB776			
GRAND PRIX 150	150	1998 →	FDB680			ST/EF				
GD 250 N	250	2013 →	FDB2114			XRAC/ST/P	FDB2090			P/EF
GD 250 R	250	2015 →	FDB2114			XRAC/ST/P	FDB2090			P/EF
GT COMET 250 (Naked)	250	2004 → 2005	FDB312			ST/P/EF	FDB312			ST/P/EF
GT 250 R (Carbs)	250	2005 → 2007	FDB312	2		ST/P/EF	FDB312			ST/P/EF
GT 250 (Naked)	250	2006 → 2012	FDB312			ST/P/EF	FDB312			ST/P/EF
GT 250 R (Inj)	250	2008 → 2013	FDB312	2		ST/P/EF	FDB312			ST/P/EF
GT 250 i (Naked)	250	2013 →	FDB312			ST/P/EF	FDB2090			P/EF
GT 250 R (Inj)	250	2014 →	FDB312	2		ST/P/EF	FDB2090			P/EF
GT 250 P	250	2015 →	FDB312			ST/P/EF	FDB2090			P/EF
GV 250 AQUILA	250	2004 → 2007	FDB312			ST/P/EF	FSB776			
GV 250	250	2008 →	FDB312			ST/P/EF	FSB776			
MS3 250	250	2006 →	FDB497		left	ST/SM/SG/P/EF				
MS3 250	250	2006 →	FDB631		right	ST/SM/SG/P/EF/AG				
MS3 250	250	2006 →					FDB631			ST/SM/SG/P/EF/AG
GA 300	300	1998 →	FDB339			ST/P/EF				
GT 300 R	300	2016 →	FDB2114			XRAC/ST/P	FDB2090			P/EF
GV 300	300	2016 →	FDB2114			XRAC/ST/P	FDB2090			P/EF
GD 450	450	2016 →	FDB2114			XRAC/ST/P	FDB2090			P/EF
GT 650 COMET (Naked)	650	2004 → 2008	FDB312	2		ST/P/EF	FDB312			ST/P/EF
GT 650 S	650	2005 → 2008	FDB312	2		ST/P/EF	FDB312			ST/P/EF
GT 650 R	650	2007 → 2008	FDB312	2		ST/P/EF	FDB312			ST/P/EF

* It is recommended that in those applications where sintered pads are supplied as Original Equipment, replacement pads should also be of sintered composition.

** To avoid brake imbalance sintered pads fitted in rear calipers should only be used in combination with front calipers containing sintered pads.



	CC	KW	FROM -> TO		N° SET	L/R	COMPOUND		N° SET	L/R	COMPOUND
...HYOSUNG											
GT 650 (Naked)	650		2009 → 2011	FDB2114	2		XRAC/ST/P	FDB312			ST/P/EF
GT 650 i R	650		2009 → 2013	FDB2114	2		XRAC/ST/P	FDB312			ST/P/EF
GT 650 i (Naked)	650		2012 →	FDB2114	2		XRAC/ST/P	FDB312			ST/P/EF
GT 650 i R	650		2014 →	FDB2114	2		XRAC/ST/P	FDB2090			P/EF
GT 650 P	650		2016 →	FDB2114	2		XRAC/ST/P	FDB2090			P/EF
GV 650 AQUILA (Carb)	650		2004 → 2006	FDB312	2		ST/P/EF	FDB2156			ST/P/EF
GV 650 (EFI)	650		2007 → 2012	FDB312	2		ST/P/EF	FDB312			ST/P/EF
GV 650 Progress	650		2012 →	FDB312	2		ST/P/EF	FDB312			ST/P/EF
ST7	678		2010 →	FDB2114			XRAC/ST/P	FDB312			ST/P/EF
ST7-Deluxe	678		2012 →	FDB2114			XRAC/ST/P	FDB312			ST/P/EF
GV 700 C	700		2006 → 2009	FDB312			ST/P/EF	FDB312			ST/P/EF
GV 700 AQUILA	700		2010 →	FDB2114	2		XRAC/ST/P	FDB312			ST/P/EF
GV 1000	1000		2004 →	FDB312			ST/P/EF	FDB2156			ST/P/EF

INDIAN

Bomber (Brembo Calipers)			2010 → 2011	FRP408	2		XRAC/ST/PRP/P/CPRO/CP1	FDB108			ST/P/EF/CPRO
Chief Blackhawk (Brembo calipers)			→ 2011	FRP408	2		XRAC/ST/PRP/P/CPRO/CP1	FDB108			ST/P/EF/CPRO
Chief Blackhawk Dark (Brembo calipers)			→ 2011	FRP408	2		XRAC/ST/PRP/P/CPRO/CP1	FDB108			ST/P/EF/CPRO
Chief Deluxe (Brembo calipers)			→ 2009	FRP408	2		XRAC/ST/PRP/P/CPRO/CP1	FDB108			ST/P/EF/CPRO
Chief/Deluxe/Springfield/Roadmaster/Vintage			2002 → 2008	FDB2040			ST/PRP/P	FDB2040			ST/PRP/P
Chief Roadmaster (Brembo calipers)			2009 → 2011	FRP408	2		XRAC/ST/PRP/P/CPRO/CP1	FDB108			ST/P/EF/CPRO
Chief Standard (Brembo calipers)			2009 → 2011	FRP408	2		XRAC/ST/PRP/P/CPRO/CP1	FDB108			ST/P/EF/CPRO
Chief Vintage (Brembo calipers)			2009 → 2013	FRP408	2		XRAC/ST/PRP/P/CPRO/CP1	FDB108			ST/P/EF/CPRO
Chief Classic (Brembo calipers)			2011 → 2013	FRP408	2		XRAC/ST/PRP/P/CPRO/CP1	FDB108			ST/P/EF/CPRO
Dark Horse (Brembo calipers)			2010 → 2013	FRP408	2		XRAC/ST/PRP/P/CPRO/CP1	FDB108			ST/P/EF/CPRO
Road Master/Vintage			2002 → 2008	FDB2040			ST/PRP/P	FDB2040			ST/PRP/P
Scout All models Scout/Deluxe/Springfield			2002 → 2008	FDB2040			ST/PRP/P	FDB2040			ST/PRP/P
Spirit All models Deluxe/Springfield/Roadblaster			2002 → 2008	FDB2040			ST/PRP/P	FDB2040			ST/PRP/P
FTR 1200	1200		2019 →	FDB2265	2		ST/EF/CPRO	FDB2074			ST/SM/P/EF/CPRO/AG
Chief Classic	1811	55	2014 → 2016	FDB2158	2		ST	FDB664			ST/P/EF
Chief Vintage	1811	55	2014 →	FDB2158	2		ST	FDB664			ST/P/EF
Chief Dark Horse	1811	55	2015 →	FDB2158	2		ST	FDB664			ST/P/EF
Chief Vintage	1811	62	2018 →	FDB2158	2		ST	FDB664			ST/P/EF
Chieftain	1811	55	2014 → 2016	FDB2158			ST	FDB664			ST/P/EF
Chieftain	1811	62	2018 →	FDB2158	2		ST	FDB664			ST/P/EF
Chieftain Classic	1811	62	2018 →	FDB2158	2		ST	FDB664			ST/P/EF
Chieftain Dark Horse	1811	62	2018 →	FDB2158	2		ST	FDB664			ST/P/EF
Chieftain Limited	1811	62	2018 →	FDB2158	2		ST	FDB664			ST/P/EF
Roadmaster	1811	55	2015 → 2016	FDB2158	2		ST	FDB664			ST/P/EF
Roadmaster	1811	62	2018 →	FDB2158	2		ST	FDB664			ST/P/EF
Springfield Dark Horse	1811		2018 →	FDB2158	2		ST	FDB664			ST/P/EF

INNOCENTI

LAMBRETTA J 100	100		→	FSB842				FSB842			
LAMBRETTA 125 DL	125		→	FSB843				FSB843			
LAMBRETTA 125 LI	125		→	FSB839				FSB839			
LAMBRETTA J 125	125		→	FSB842				FSB842			
LAMBRETTA 150 DL	150		→	FSB843				FSB843			
LAMBRETTA 150 LI	150		→	FSB839				FSB839			
LAMBRETTA 175 LI	175		→	FSB839				FSB839			
LAMBRETTA 175 TV II	175		→					FSB839			
LAMBRETTA 200 DL	200		→	FSB843				FSB843			
LAMBRETTA 200 DL (con kit anteriore x pastiglia)	200		→					FSB843			

ITALJET

ADLY 50	50		1990 → 1995					FSB731			
BAZOOKA 1 50	50		1991 →	FSB914				FSB862			
BAZOOKA 2 50	50		1992 → 1997	FDB636			P/EF	FSB862			
CRUISE 50	50		1995 → 1998	FDB636			P/EF				
DRAGSTER 50	50		1998 → 2003	FRP405			ST/SG/PRP/P/EF	FRP405			ST/SG/PRP/P/EF
FORMULA 50	50		1994 → 1996	FDB784			EF/AG	FDB680			ST/EF
FORMULA 50	50		1997 → 2003	FRP405			ST/SG/PRP/P/EF	FRP405			ST/SG/PRP/P/EF
PISTA 2 50	50		1992 → 1996	FDB636			P/EF	FSB862			
REPORTER 50	50		1990 → 1993	FSB914				FSB862			
RG 50	50		1998 →	FRP405			ST/SG/PRP/P/EF				
SCOOP 50	50		1993 →	FDB636			P/EF	FSB862			
SHOPPING 50	50		1990 →	FSB910				FSB889			
T 50	50		→	FSB837				FSB837			
TORPEDO 50	50		1997 →	FRP405			ST/SG/PRP/P/EF	FSB777			

* It is recommended that in those applications where sintered pads are supplied as Original Equipment, replacement pads should also be of sintered composition.

** To avoid brake imbalance sintered pads fitted in rear calipers should only be used in combination with front calipers containing sintered pads.



CC KW FROM -> TO N° SET L/R COMPOUND



N° SET L/R COMPOUND

...ITALJET

VELOCIFERO 50	50	1994 → 2002	FSB762				FSB777			
Velocifero 50	50	1998 → 2003	FSB958				FSB777			
YANKEE 8 50	50	1994 →	FDB636			P/EF	FSB862			
FORMULA 80	80	1994 →	FDB784			EF/AG	FDB680			ST/EF
MILLENIUM 100	100	2000 → 2001	FDB383			SG/P/EF	FSB947			
MILLENIUM 100	100	2002 → 2003	FDB2128			EF	FSB947			
T 100	100	→	FSB837				FSB837			
DRAGSTER 125	125	1999 →	FRP405			ST/SG/PRP/P/EF				
DRAGSTER 125	125	2000 → 2003	FRP405			ST/SG/PRP/P/EF	FRP405			ST/SG/PRP/P/EF
FORMULA 125	125	1994 → 1996	FDB784			EF/AG	FDB680			ST/EF
FORMULA 125	125	1997 → 2003	FRP405			ST/SG/PRP/P/EF	FRP405			ST/SG/PRP/P/EF
JET SET 125	125	2002 → 2003	FDB2128			EF				
JUPITER 125	125	2001 →	FDB2003			ST/SM/P/EF	FDB2083			ST/SM/P/EF
JUPITER 125 / 150 / 250	125	2002 → 2003	FDB2003			ST/SM/P/EF	FDB2147			AG
MILLENIUM 125	125	2000 → 2001	FDB383			SG/P/EF	FSB947			
MILLENIUM 125	125	2001 → 2003	FDB2128			EF	FSB947			
RANGER 125	125	1985 →	FSB837				FSB837			
SKIPPER 125	125	1985 →	FSB837				FSB837			
T 125	125	→	FSB837				FSB837			
TORPEDO 125	125	1999 → 2003	FRP405			ST/SG/PRP/P/EF				
TWIN 125	125	1998 → 2000	FRP405			ST/SG/PRP/P/EF	FRP405			ST/SG/PRP/P/EF
JET SET 150	150	2002 → 2003	FDB2128			EF				
MILLENIUM 150	150	2000 → 2001	FDB383			SG/P/EF	FSB947			
MILLENIUM 150	150	2001 → 2003	FDB2128			EF	FSB947			
DRAGSTER 180	180	1999 →	FRP405			ST/SG/PRP/P/EF				
DRAGSTER 180	180	2000 → 2003	FRP405			ST/SG/PRP/P/EF	FRP405			ST/SG/PRP/P/EF
JUPITER 250	250	2001 →	FDB2003			ST/SM/P/EF	FDB2083			ST/SM/P/EF
JUPITER 250	250	2002 →	FDB2003			ST/SM/P/EF	FDB2147			AG
T 250	250	→	FSB837				FSB837			
T 250 PIUMA	250	1985 →	FSB837				FSB837			
BOSS 350 4 T	350	→	FSB837				FSB837			
BOSS 350 ENDURO	350	→	FDB207			ST/P/EF/CP1	FSB837			
CUSTOM 350	350	1985 →	FSB837							
CX 350	350	1985 →	FDB207			ST/P/EF/CP1	FSB837			
EXPLORER 350	350	1985 →	FSB837				FSB837			
H&H 350 2 T	350	→	FSB837				FSB837			
ROAD MASTER 350	350	→	FDB207			ST/P/EF/CP1				
SCOTT 350 4 T	350	→	FSB837				FSB837			
T 350 PIUMA	350	1985 →	FSB837				FSB837			
GRIFON 650	650	2007 →	FDB312	2		ST/P/EF				
GRIFON 900	900	2001 →	FRP408			XRAC/ST/PRP/P/CPRO/CP1				

JONWAY

YY 50 QT-10 (2T) Viper	50	2007 → 2009	FDB312			ST/P/EF				
YY 50 QT-10 (4T) Viper	50	2007 → 2009	FDB312			ST/P/EF				
YY 50 QT-28 (2T) Raptor	50	2007 → 2009	FDB312			ST/P/EF				
YY 50 QT-28 (4T) Raptor	50	2007 → 2009	FDB312			ST/P/EF				
YY 50 QT-6 (2T) Agility	50	2007 → 2009	FDB312			ST/P/EF				
YY 50 QT-6 (4T) Agility	50	2007 → 2009	FDB312			ST/P/EF				
YY 80 QT-6 (4T) Agility	80	2007 → 2009	FDB312			ST/P/EF				
YY 125	125	2008 → 2009	FDB631			ST/SM/SG/P/EF/AG	FDB631			ST/SM/SG/P/EF/AG
YY 150	150	2008 → 2009	FDB631			ST/SM/SG/P/EF/AG	FDB631			ST/SM/SG/P/EF/AG
YY 150 T-19	150	2008 → 2009	FDB312			ST/P/EF	FDB312			ST/P/EF
YY 250 T-19	250	2008 → 2009	FDB312			ST/P/EF	FDB312			ST/P/EF
YY 250/250 A	250	2008 → 2009	FDB631			ST/SM/SG/P/EF/AG	FDB631			ST/SM/SG/P/EF/AG

KAWASAKI

AE 50 - A1 - A2	50	1981 → 1982	FSB722				FSB722			
AR 50	50	1981 → 1995	FDB313			SG/P/EF	FSB722			
KMX 50	50	1988 →	FDB313			SG/P/EF	FSB722			
KSR 50 I/II	50	1990 → 1991	FDB313			SG/P/EF	FDB314			ST/SG/P/EF
KX 60 A1 - A2 - B1/6	60	1985 → 1991	FSB802				FSB802			
KX 60 B9	60	1993 → 2004	FDB494			P				
KX 65	65	1999 →	FDB2110			SG	FDB250			SG/P/EF
KX 65	65	2000 →	FDB2110			SG	FDB250			SG/P/EF
AE 80 A1 - B1	80	1981 → 1982	FSB722				FSB722			
AR 80	80	1981 → 1982	FDB313			SG/P/EF	FSB722			
KD 80	80	1988 → 1990	FDB313			SG/P/EF	FSB716			
KX 80 R7-T7-W1/2-Y1/2	80	1997 → 2000	FDB2080			SG	FDB381			SG/P/EF
KX 80 E1	80	1983 →					FSB802			

* It is recommended that in those applications where sintered pads are supplied as Original Equipment, replacement pads should also be of sintered composition.

** To avoid brake imbalance sintered pads fitted in rear calipers should only be used in combination with front calipers containing sintered pads.

1050



CC KW FROM -> TO N° SET L/R COMPOUND N° SET L/R COMPOUND

...KAWASAKI

KX 80 E2	80	1984	→ 1986	FDB313			SG/P/EF	FSB802			
KX 80 H - K2	80	1987	→ 1987	FDB314			ST/SG/P/EF	FSB802			
KX 80 R3	80	1993	→ 1996	FDB313			SG/P/EF	FDB381			SG/P/EF
KX 80 S1 - V1	80	1988	→ 1991	FDB313			SG/P/EF	FDB381			SG/P/EF
KX 80 S1 - V1	80	1992	→	FDB661			SG/P	FDB314			ST/SG/P/EF
KX 85 / 85-2 A1 / B1	85	2001	→	FDB2080			SG	FDB381			SG/P/EF
KC 100 C1/2/3/4	100	1980	→ 1983	FBS722				FBS722			
KE 100 all models	100	1979	→ 1991	FBS722				FBS722			
KH 100 A2 - A4	100	1978	→ 1981	FBS721				FBS722			
KH 100 G2 - G3	100	1981	→ 1982					FBS722			
KH 100 G4	100	1983	→	FDB314			ST/SG/P/EF	FBS722			
KM 100 A4 - A6	100	1978	→ 1981	FBS721				FBS722			
KX 100	100	1988	→ 1991	FDB313			SG/P/EF	FDB381			SG/P/EF
KX 100 B7 / C1 / C2 / C3	100	1997	→ 2000	FDB2080			SG	FDB381			SG/P/EF
KLX 110 R	110	2002	→	FBS802				FBS722			
KAZER 115 R	115	1998	→ 1999	FDB631			ST/SM/SG/P/EF/AG	FBS722			
AR 125 A1 - LC	125	1982	→ 1994	FDB314			ST/SG/P/EF	FDB721			
BN 125 A1/A2 ELIMINATOR	125	1998	→ 1999	FDB250			SG/P/EF	FBS721			
BN 125 A3/A4 ELIMINATOR	125	2000	→	FDB631			ST/SM/SG/P/EF/AG	FBS721			
J125	125	2016	→	FDB570			XRAC/ST/SM/P/EF/CPRO	FDB2248			EF
KDX 125 A1	125	1990	→ 1994	FDB313			SG/P/EF	FDB659			SG/P/EF
KE 125 A4 - A10	125	1976	→ 1985	FBS797				FBS721			
KH 125 A1 -A3	125	1977	→ 1981					FBS716			
KH 125 EX	125	1982	→ 1983	FDB314			ST/SG/P/EF	FBS721			
KH 125 K1	125	1982	→ 1998	FDB250			SG/P/EF	FBS721			
KH 125 K2-4 - L1	125	1982	→ 1983	FDB314			ST/SG/P/EF	FBS721			
KLX 125 A	125	2003	→ 2006	FBS723				FBS723			
KLX 125 L	125	2003	→ 2006	FDB2133			SG/EF	FBS723			
KLX 125 C	125	2010	→	FDB497			ST/SM/SG/P/EF	FDB250			SG/P/EF
KLX 125 D (D-Tracker)	125	2010	→	FDB497			ST/SM/SG/P/EF	FDB250			SG/P/EF
KMX 125	125	1986	→ 1998	FDB313			SG/P/EF	FDB314			ST/SG/P/EF
KMX 125	125	1999	→ 2003	FDB2133			SG/EF	FDB314			ST/SG/P/EF
KX 125 A3 - A7	125	1974	→ 1980	FBS797				FBS721			
KX 125 B1	125	1981	→ 1981	FDB313			SG/P/EF	FBS721			
KX 125 B2 - C1	125	1982	→ 1985	FDB314			ST/SG/P/EF	FBS716			
KX 125	125	1986	→ 1986	FDB314			ST/SG/P/EF	FDB314			ST/SG/P/EF
KX 125 E2 - D1 - E2	125	1987	→ 1988	FDB494			P	FDB314			ST/SG/P/EF
KX 125	125	1989	→ 1994	FDB497			ST/SM/SG/P/EF	FDB659			SG/P/EF
KX 125 K2-K4	125	1995	→ 1997	FDB892			ZR/SG/P/EF/CPRO	FDB659			SG/P/EF
KX 125	125	1996	→ 2002	FDB892			ZR/SG/P/EF/CPRO	FDB539			SG/P/EF
KX 125	125	2003	→	FDB892			ZR/SG/P/EF/CPRO	FDB539			SG/P/EF
Ninja	125	11	2019	→	FDB631		ST/SM/SG/P/EF/AG	FDB631			ST/SM/SG/P/EF/AG
Z 125	125	11	2019	→	FDB631		ST/SM/SG/P/EF/AG	FDB631			ST/SM/SG/P/EF/AG
KDX 175 all models	175	1980	→ 1982	FBS797				FBS721			
KE 175 B1 -B3	175	1976	→ 1978	FBS797				FBS797			
KE 175 D1 - D5	175	1979	→ 1983	FBS797				FBS717			
KDX 200 A1 - A2	200	1983	→ 1985	FBS717				FBS716			
KDX 200 C1	200	1986	→ 1988	FDB314			ST/SG/P/EF	FBS716			
KDX 200 E1	200	1989	→	FDB314			ST/SG/P/EF	FDB659			SG/P/EF
KDX 200 SR	200	1990	→ 1993	FDB497			ST/SM/SG/P/EF	FDB659			SG/P/EF
KDX 200 E6 / H1 - H3	200	1994	→ 2003	FDB892			ZR/SG/P/EF/CPRO	FDB659			SG/P/EF
KMX 200	200	1988	→ 1992	FDB313			SG/P/EF	FDB314			ST/SG/P/EF
VN 200	200	2007	→	FDB574	2		ZRAC/XRAC/ST/P/EF/CP1	FDB2049			XRAC/ST/P/EF/CP1
Z 200 A1 - A5	200	1977	→ 1982					FBS721			
Z 200 A6	200	1983	→	FDB314			ST/SG/P/EF	FBS721			
KDX 220 RA4	220	1997	→ 2003	FDB892			ZR/SG/P/EF/CPRO	FDB659			SG/P/EF
BJ 250 B1-B7A Estrella	250	1992	→ 1999	FDB314			ST/SG/P/EF	FDB314			ST/SG/P/EF
BJ 250 C1-C7 Estrella-RS	250	1999	→ 2002	FDB314			ST/SG/P/EF	FDB314			ST/SG/P/EF
BJ 250 D1-D7 Estrella Custom	250	1996	→ 2002					FBS718			
BJ 250 E1-E4A Estrella RS Custom	250	1996	→ 1999					FBS718			
BJ 250 F1/F2 (250 TR)	250	2002	→ 2003	FDB2049			XRAC/ST/P/EF/CP1	FBS718			
EL 250 all models	250	1991	→ 1994	FDB339			ST/P/EF	FBS718			
EX 250 NINJA	250	1986	→ 1987	FDB339			ST/P/EF	FDB339			ST/P/EF
EX 250 H1 - H2	250	1990	→	FDB481			ST/P/EF	FDB314			ST/SG/P/EF
GPX 250 R NINJA	250	1987	→ 1995	FDB481			ST/P/EF	FDB508			P
GPZ 250	250	1985	→	FDB314	2		ST/SG/P/EF	FDB339			ST/P/EF
KDX 250 B1	250	1979	→	FBS799				FBS724			
KDX 250 BALIUS	250	1991	→ 1993	FDB481			ST/P/EF	FDB314			ST/SG/P/EF
KDX 250 SR-D	250	1991	→ 1993	FDB497			ST/SM/SG/P/EF	FDB659			SG/P/EF
KDX 250 K2-K4	250	1995	→	FDB892			ZR/SG/P/EF/CPRO	FDB539			SG/P/EF
KH 250 B1 - S	250	1977	→ 1982	FDB132			P	FBS793			
KL 250 SUPER SHERPA	250	2000	→	FDB2080			SG	FDB314			ST/SG/P/EF
KL 250 A1 - A2	250	1978	→ 1979	FBS799				FBS724			
KL 250 A3 - A4	250	1980	→ 1984	FBS797				FBS717			

* It is recommended that in those applications where sintered pads are supplied as Original Equipment, replacement pads should also be of sintered composition.

** To avoid brake imbalance sintered pads fitted in rear calipers should only be used in combination with front calipers containing sintered pads.



CC KW FROM -> TO N° SET L/R COMPOUND N° SET L/R COMPOUND

...KAWASAKI

KL 250 C1	250	1980 → 1984	FSB797				FSB717			
KLE 250 ANHELO	250	1993 → 1999	FDB481			ST/P/EF	FDB314			ST/SG/P/EF
KLE 250 ANHELO	250	2000 → 2002	FDB481			ST/P/EF	FDB2015			SG
KLR 250 all models	250	1984 → 2000	FDB314			ST/SG/P/EF	FSB717			
KLX 250	250	1979 → 1980	FSB797				FSB721			
KLX 250	250	1993 → 1997	FDB892			ZR/SG/P/EF/CPRO	FDB659			SG/P/EF
KLX 250 D-Tracker	250	1998 → 2003	FDB892			ZR/SG/P/EF/CPRO	FDB539			SG/P/EF
KLX 250 H1 SUPER SHERPA	250	1998 → 1998	FDB2080			SG	FDB314			ST/SG/P/EF
KLX 250 S	250	2006 → 2007	FDB892			ZR/SG/P/EF/CPRO	FDB539			SG/P/EF
KLX 250 S	250	16 2009 →	FDB497			ST/SM/SG/P/EF	FDB539			SG/P/EF
KMX 250	250	1989 →	FDB314			ST/SG/P/EF	FDB314			ST/SG/P/EF
KR-1 250	250	1988 →	FDB481			ST/P/EF	FDB508			P
KR-1 250	250	1989 →	FDB508	2		P	FDB508			P
KR-1 250 C1 - C3	250	1990 → 1992	FDB574	2		ZRAC/XRAC/ST/P/EF/CP1	FDB508			P
KX 250 A all models	250	1974 → 1979	FSB799				FSB724			
KX 250 B2 - B3	250	1980 → 1981	FSB799				FSB721			
KX 250 B1	250	1982 → 1982	FDB313			SG/P/EF	FDB721			
KX 250 C1 - C2	250	1983 → 1985	FDB314			ST/SG/P/EF	FSB721			
KX 250	250	1986 → 1986	FDB314			ST/SG/P/EF	FDB314			ST/SG/P/EF
KX 250 E1 - F1	250	1987 → 1988	FDB494			P	FDB314			ST/SG/P/EF
KX 250	250	1989 → 1993	FDB497			ST/SM/SG/P/EF	FDB659			SG/P/EF
KX 250	250	1994 → 1995	FDB892			ZR/SG/P/EF/CPRO	FDB659			SG/P/EF
KX 250	250	1996 → 2002	FDB892			ZR/SG/P/EF/CPRO	FDB539			SG/P/EF
KX 250	250	2003 →	FDB892			ZR/SG/P/EF/CPRO	FDB539			SG/P/EF
KX 250 F	250	2004 →	FDB892			ZR/SG/P/EF/CPRO	FDB2162			SG/P/EF
LX 250 ELIMINATOR - SE	250	1990 →	FDB339			ST/P/EF				
NINJA 250R (EX250K)	250	2008 → 2012	FDB631			ST/SM/SG/P/EF/AG	FDB631			ST/SM/SG/P/EF/AG
NINJA 250SL (BX250A)	250	2015 →	FDB631			ST/SM/SG/P/EF/AG	FDB631			ST/SM/SG/P/EF/AG
S1 250 B	250	1975 →	FSB800				FSB793			
SC 250 EPSILON	250	2002 →	FDB2085			ST/SM/P/EF	FDB2132			EF
Z 250	250	1983 →	FDB339	2		ST/P/EF	FSB718			
Z 250 GP BELT DRIVE	250	1983 →	FDB339	2		ST/P/EF	FSB718			
Z 250 LTD	250	1983 →	FSB800				FSB721			
Z250SL (BR250E)	250	2015 →	FDB631			ST/SM/SG/P/EF/AG	FDB631			ST/SM/SG/P/EF/AG
Z 250 A1 - A2	250	1978 → 1980	FDB132			P				
Z 250 A3	250	1981 → 1983	FDB298			P				
Z 250 B1 - B2	250	1980 → 1983	FSB800				FSB718			
Z 250 C1 - C2	250	1981 → 1983	FSB800				FSB721			
Z 250 G1 - G2	250	1981 → 1983	FSB800				FSB721			
Z 250 J1	250	1981 → 1983	FDB298			P				
ZXR 250	250	1989 →	FDB508	2		P	FDB314			ST/SG/P/EF
ZZR 250 (EX 250 H)	250	1990 → 1993	FDB481	2		ST/P/EF	FDB314			ST/SG/P/EF
J300	300	2014 →	FDB570			XRAC/ST/SM/P/EF/CPRO	FDB2248			EF
KLX 300 R	300	1997 → 2003	FDB892			ZR/SG/P/EF/CPRO	FDB539			SG/P/EF
NINJA 300 (EX300A)	300	2013 →	FDB631			ST/SM/SG/P/EF/AG	FDB631			ST/SM/SG/P/EF/AG
Versys-x	300	2017 →	FDB570			XRAC/ST/SM/P/EF/CPRO	FDB631			ST/SM/SG/P/EF/AG
Z300	300	2015 →	FDB631			ST/SM/SG/P/EF/AG	FDB631			ST/SM/SG/P/EF/AG
GPZ 305 A1	305	1983 → 1996	FDB314	2		ST/SG/P/EF	FSB718			
GPZ 305 B2 - B3	305	1983 → 1996	FDB314	2		ST/SG/P/EF	FSB718			
GPZ 305 BELT DRIVE	305	1983 → 1996	FDB314	2		ST/SG/P/EF	FSB718			
Ninja 400	399	33 2018 →	FDB631			ST/SM/SG/P/EF/AG	FDB631			ST/SM/SG/P/EF/AG
Z 400	399	33 2019 →	FDB631			ST/SM/SG/P/EF/AG	FDB631			ST/SM/SG/P/EF/AG
EX 4 400	400	1995 →	FDB481	2		ST/P/EF	FDB314			ST/SG/P/EF
GPX 400	400	1985 →	FDB314	2		ST/SG/P/EF	FDB339			ST/P/EF
GPX 400 R	400	1987 →	FDB508	2		P	FDB481			ST/P/EF
GPX 400 R	400	1988 →	FDB508	2		P	FDB508			P
GPZ 400	400	1983 → 1984	FDB299	2		P	FDB298			P
GPZ 400	400	1985 → 1987	FDB314	2		ST/SG/P/EF	FDB339			ST/P/EF
GPZ 400 R	400	1990 →	FDB508	2		P	FDB481			ST/P/EF
KH 400 A3-5	400	1976 → 1981	FDB132			P	FSB793			
KLE 400 VULCAN	400	1990 →	FDB339			ST/P/EF				
KLE 400	400	1991 →	FDB481			ST/P/EF	FDB314			ST/SG/P/EF
LX 400 ELIMINATOR - SE	400	1990 →	FDB314	2		ST/SG/P/EF				
VN 400 VULCAN	400	1995 →	FDB339			ST/P/EF	FSB719			
VN 400 CLASSIC	400	1999 →	FDB2048			XRAC/ST/P/EF/CP1	FSB719			
XANTUS 400	400	1992 →	FDB508			P	FDB314			ST/SG/P/EF
Z 400 F2	400	1985 → 1987	FDB314	2		ST/SG/P/EF	FDB339			ST/P/EF
Z 400 G1	400	1979 →	FDB132			P	FSB718			
Z 400 GP (M1)	400	1983 →	FDB299	2		P	FDB298			P
Z 400 J1 LTD	400	1980 → 1981	FDB132			P	FSB719			
Z 400 J2 - J3	400	1981 → 1983	FDB299	2		P	FSB719			
ZL 400	400	1986 → 1987	FDB339			ST/P/EF	FSB719			
ZL 400 ELIMINATOR	400	1988 → 1992	FDB339			ST/P/EF	FDB339			ST/P/EF
ZL 400 ELIMINATOR	400	1993 →	FDB481			ST/P/EF	FDB339			ST/P/EF

* It is recommended that in those applications where sintered pads are supplied as Original Equipment, replacement pads should also be of sintered composition.

** To avoid brake imbalance sintered pads fitted in rear calipers should only be used in combination with front calipers containing sintered pads.



CC KW FROM -> TO N° SET L/R COMPOUND N° SET L/R COMPOUND

...KAWASAKI

ZR 400 ZEPHYR	400	1993	→ 1995	FDB481	2		ST/P/EF	FDB2012		ST/P/EF
ZR 400 A1 - F	400	1983	→	FDB314	2		ST/SG/P/EF	FSB718		
ZR 400 ZEPHYR (ZR-C)	400	1989	→ 1992	FDB481	2		ST/P/EF	FDB508		P
ZRX 400	400	1998	→	FDB873			ZRAC/XRAC/ST/P/EF/CPRO/CP1	FDB2012		ST/P/EF
ZRX 400 (ZR 400 E2)	400	1999	→ 2001	FDB2124	2		ST/P	FDB2012		ST/P/EF
ZX 4 400	400	1988	→	FDB508			P	FDB508		P
ZX 400 C2	400	1985	→	FDB314	2		ST/SG/P/EF	FDB339		ST/P/EF
ZX 400 L	400	1992	→	FDB741	2		P	FDB338		ST/P/EF
ZXR 400	400	1991	→	FDB574	2		ZRAC/XRAC/ST/P/EF/CP1	FDB338		ST/P/EF
ZXR 400 (ZX400-L)	400	1992	→	FDB741	2		P	FDB338		ST/P/EF
ZXR 400	400	1994	→	FDB481	2		ST/P/EF	FDB2012		ST/P/EF
ZZR 400	400	1990	→ 1992	FDB574	2		ZRAC/XRAC/ST/P/EF/CP1	FDB481		ST/P/EF
ZZR 400	400	1993	→	FDB574	2		ZRAC/XRAC/ST/P/EF/CP1	FDB2012		ST/P/EF
KX 420 A1 - A2	420	1980	→	FSB799				FSB724		
Z 440 A2 - C1	440	1979	→ 1982	FDB132			P	FSB718		
Z 440 C2	440	1981	→	FDB298			P	FSB718		
Z 440 D2 - D4 LTD	440	1979	→ 1982	FDB132			P	FSB718		
Z 440 D5 LTD	440	1981	→ 1983	FDB298			P	FSB718		
Z 440 H1 - H2	440	1981	→ 1983	FDB298			P	FSB718		
KLX 450 R	450	2007	→	FDB892			ZR/SG/P/EF/CPRO	FDB2162		SG/P/EF
KX 450	450	2019	→	FDB892			ZR/SG/P/EF/CPRO	FDB2162		SG/P/EF
KX 450 F	450	2006	→	FDB892			ZR/SG/P/EF/CPRO	FDB2162		SG/P/EF
LTD450 (EN450 A1-A5)	454	1986	→ 1989	FDB339			ST/P/EF	FSB719		
EN 500 all models	500	1990	→ 1993	FDB339			ST/P/EF	FSB719		
ER-5 500 (ER)	500	1997	→ 2000	FDB481			ST/P/EF	FSB718		
ER-5 500 (ER)	500	2001	→	FDB2048			XRAC/ST/P/EF/CP1	FSB718		
EX 500 all models	500	1987	→ 1991	FDB481			ST/P/EF	FSB718		
GPZ 500 S	500	1987	→	FDB339			ST/P/EF	FSB718		
GPZ 500 S	500	1988	→	FDB314			ST/SG/P/EF	FSB718		
GPZ 500 S	500	1989	→ 1992	FDB314	2		ST/SG/P/EF	FDB339		ST/P/EF
GPZ 500 S	500	1993	→	FDB574	2		ZRAC/XRAC/ST/P/EF/CP1	FDB481		ST/P/EF
GPZ 500 S	500	1994	→ 1997	FDB481	2		ST/P/EF	FDB314		ST/SG/P/EF
KH 500 H1 -B/D/E	500	1974	→ 1975					FSB794		
KH 500 A8	500	1976	→	FDB132			P	FSB794		
KLE 500	500	1991	→	FDB481			ST/P/EF	FDB314		ST/SG/P/EF
KR 500 ES	500	1993	→	FDB497			ST/SM/SG/P/EF	FDB659		SG/P/EF
KX 500	500	1986	→	FDB314			ST/SG/P/EF	FDB314		ST/SG/P/EF
KX 500	500	1989	→ 1994	FDB497			ST/SM/SG/P/EF	FDB659		SG/P/EF
KX 500	500	1994	→ 1995	FDB892			ZR/SG/P/EF/CPRO	FDB659		SG/P/EF
KX 500 A1 - A2	500	1983	→ 1985	FDB314			ST/SG/P/EF	FSB721		
KX 500 C1	500	1987	→ 1988	FDB494			P	FDB314		ST/SG/P/EF
KX 500 E8/E9	500	1996	→	FDB892			ZR/SG/P/EF/CPRO	FDB539		SG/P/EF
Z 500 A1 - A3	500	1979	→ 1980	FDB132	2		P	FDB151		ST/PRP/P
Z 500 B1 - B3	500	1979	→ 1980	FDB132	2		P	FDB151		ST/PRP/P
Z 500 F	500	1983	→	FDB314	2		ST/SG/P/EF	FSB718		
ZR 500 A1	500	1983	→	FDB314	2		ST/SG/P/EF	FSB718		
ZZ-R 500	500	1990	→	FDB574	2		ZRAC/XRAC/ST/P/EF/CP1	FDB481		ST/P/EF
A1 550 LTD	550	1980	→	FDB132	2		P	FSB719		
Z 550 A3 - C1 - C2 LTD	550	1980	→	FDB299	2		P	FSB719		
Z 550 A1	550	1980	→	FDB132	2		P	FSB719		
Z 550 F	550	1983	→ 1984	FDB314	2		ST/SG/P/EF	FSB718		
Z 550 G1 SHAFT	550	1983	→	FDB314	2		ST/SG/P/EF	FSB719		
Z 550 GT - SPORT	550	1983	→	FDB314	2		ST/SG/P/EF	FSB719		
Z 550 GP D1 - H1 - H2	550	1981	→ 1983	FDB299	2		P	FDB298		P
Z 550 GP	550	1984	→	FDB299	2		P	FDB298		P
ZEPHYR 550	550	1991	→	FDB481	2		ST/P/EF	FDB508		P
ZR 550 ZEPHYR	550	1990	→ 1992	FDB481	2		ST/P/EF	FDB508		P
ZR 550 ZEPHYR	550	1993	→ 1999	FDB481	2		ST/P/EF	FDB2012		ST/P/EF
ZR 550 A1	550	1983	→ 1984	FDB314	2		ST/SG/P/EF	FSB718		
KLR 570	570	1988	→	FDB314			ST/SG/P/EF	FSB721		
ZX 6RR (ZX 599 B1)	599	2003	→ 2006	FDB2164	2		ZRAC/XRAC/ST	FDB2012		ST/P/EF
GPX 600 R (ZX)	600	1988	→ 1996	FDB481	2		ST/P/EF	FDB481		ST/P/EF
GPX 600 R WARBIRD	600	1988	→ 1996	FDB481	2		ST/P/EF	FDB481		ST/P/EF
GPZ 600 R	600	1985	→ 1989	FDB339	2		ST/P/EF	FDB339		ST/P/EF
KLE 600	600	1992	→	FDB481			ST/P/EF	FDB314		ST/SG/P/EF
KLR 600	600	1984	→ 1988	FDB314			ST/SG/P/EF	FSB721		
KLR 600 ELECTRIC STARTER	600	1985	→	FDB314			ST/SG/P/EF	FSB721		
KLR 600 S	600	1992	→	FDB314			ST/SG/P/EF	FSB721		
KLX 600 R	600	1993	→	FDB892			ZR/SG/P/EF/CPRO	FDB659		SG/P/EF
ZL 600 A1/A2	600	1985	→ 1994	FDB339			ST/P/EF	FSB719		
ZL 600 B1 ELIMINATOR	600	1995	→ 1997	FDB481			ST/P/EF	FSB719		
ZX 6R 600 D1-D2 (DX 6)	600	1990	→ 1993	FDB574	2		ZRAC/XRAC/ST/P/EF/CP1	FDB481		ST/P/EF
ZX 6R 600 NINJA	600	1994	→ 1997	FDB574	2		ZRAC/XRAC/ST/P/EF/CP1	FDB2012		ST/P/EF
ZX 6R 600 NINJA	600	1998	→ 2001	FDB873	2		ZRAC/XRAC/ST/P/EF/CPRO/CP1	FDB2012		ST/P/EF

* It is recommended that in those applications where sintered pads are supplied as Original Equipment, replacement pads should also be of sintered composition.

** To avoid brake imbalance sintered pads fitted in rear calipers should only be used in combination with front calipers containing sintered pads.



CC KW FROM -> TO N° SET L/R COMPOUND N° SET L/R COMPOUND

...KAWASAKI

ZX 6R 600 NINJA (Racing Applications)	600	1998 → 2001	FDB2144	2		XRAC/ST/P	FDB2012		ST/P/EF
ZX 6R 600 NINJA	600	2007 →	FDB2220	2		XRAC/ST/CPRO/CP1	FDB2012		ST/P/EF
ZZR 600	600	1990 → 1992	FDB574	2		ZRAC/XRAC/ST/P/EF/CP1	FDB481		ST/P/EF
ZZR 600	600	1993 →	FDB574	2		ZRAC/XRAC/ST/P/EF/CP1	FDB2012		ST/P/EF
ZX-6R Ninja	636	95 2019 →	FDB2079	2		ZRAC/XRAC/ST/P/EF/CPRO/CP1	FDB2221		ST/P
ZX 6R (ZX 636 K1)	636	2003 → 2006	FDB2164	2		ZRAC/XRAC/ST	FDB2012		ST/P/EF
ZX 6R 636 NINJA	636	2013 →	FDB2079	2		ZRAC/XRAC/ST/P/EF/CPRO/CP1	FDB2221		ST/P
Vulcan S Cafe	649	2017 →	FDB2073			ST/SM/P/EF	FDB754		ST/P/EF
ER-6 650 F	650	2005 →	FDB2048		left	XRAC/ST/P/EF/CP1			
ER-6 650 F	650	2005 →	FDB2049		right	XRAC/ST/P/EF/CP1			
ER-6 650 F	650	2005 →					FDB2012		ST/P/EF
ER-6 650 N (ER650A)	650	53 2005 → 2008	FDB2048		left	XRAC/ST/P/EF/CP1			
ER-6 650 N (ER650A)	650	53 2005 → 2008	FDB2049		right	XRAC/ST/P/EF/CP1			
ER-6 650 N (ER650A)	650	53 2005 → 2008					FDB2012		ST/P/EF
ER-6 650 N ABS (ER650A)	650	53 2005 → 2008	FDB2048		left	XRAC/ST/P/EF/CP1			
ER-6 650 N ABS (ER650A)	650	53 2005 → 2008	FDB2049		right	XRAC/ST/P/EF/CP1			
ER-6 650 N ABS (ER650A)	650	53 2005 → 2008					FDB2012		ST/P/EF
ER-6 650 N (ER650A)	650	25 2006 → 2008	FDB2048		left	XRAC/ST/P/EF/CP1			
ER-6 650 N (ER650A)	650	25 2006 → 2008	FDB2049		right	XRAC/ST/P/EF/CP1			
ER-6 650 N (ER650A)	650	25 2006 → 2008					FDB2012		ST/P/EF
ER-6 650 N (ER650C)	650	25 2009 → 2011	FDB2048		left	XRAC/ST/P/EF/CP1			
ER-6 650 N (ER650C)	650	25 2009 → 2011	FDB2049		right	XRAC/ST/P/EF/CP1			
ER-6 650 N (ER650C)	650	25 2009 → 2011					FDB2012		ST/P/EF
ER-6 650 N (ER650C)	650	53 2009 → 2011	FDB2048		left	XRAC/ST/P/EF/CP1			
ER-6 650 N (ER650C)	650	53 2009 → 2011	FDB2049		right	XRAC/ST/P/EF/CP1			
ER-6 650 N (ER650C)	650	53 2009 → 2011					FDB2012		ST/P/EF
ER-6 650 N ABS	650	53 2011 → 2011	FDB2048		left	XRAC/ST/P/EF/CP1			
ER-6 650 N ABS	650	53 2011 → 2011	FDB2049		right	XRAC/ST/P/EF/CP1			
ER-6 650 N ABS	650	53 2011 → 2011					FDB2012		ST/P/EF
ER-6 650 N (ER650E)	650	25 2012 →	FDB2048		left	XRAC/ST/P/EF/CP1			
ER-6 650 N (ER650E)	650	25 2012 →	FDB2049		right	XRAC/ST/P/EF/CP1			
ER-6 650 N (ER650E)	650	25 2012 →					FDB2012		ST/P/EF
ER-6 650 N ABS (ER650E)	650	25 2012 →	FDB2048		left	XRAC/ST/P/EF/CP1			
ER-6 650 N ABS (ER650E)	650	25 2012 →	FDB2049		right	XRAC/ST/P/EF/CP1			
ER-6 650 N ABS (ER650E)	650	25 2012 →					FDB2012		ST/P/EF
ER-6 650 N (ER650E)	650	35 2012 →	FDB2048		left	XRAC/ST/P/EF/CP1			
ER-6 650 N (ER650E)	650	35 2012 →	FDB2049		right	XRAC/ST/P/EF/CP1			
ER-6 650 N (ER650E)	650	35 2012 →					FDB2012		ST/P/EF
ER-6 650 N ABS (ER650E)	650	35 2012 →	FDB2048		left	XRAC/ST/P/EF/CP1			
ER-6 650 N ABS (ER650E)	650	35 2012 →	FDB2049		right	XRAC/ST/P/EF/CP1			
ER-6 650 N ABS (ER650E)	650	35 2012 →					FDB2012		ST/P/EF
ER-6 650 N (ER650E)	650	53 2012 →	FDB2048		left	XRAC/ST/P/EF/CP1			
ER-6 650 N (ER650E)	650	53 2012 →	FDB2049		right	XRAC/ST/P/EF/CP1			
ER-6 650 N (ER650E)	650	53 2012 →					FDB2012		ST/P/EF
ER-6 650 N ABS (ER650E)	650	53 2012 →	FDB2048		left	XRAC/ST/P/EF/CP1			
ER-6 650 N ABS (ER650E)	650	53 2012 →	FDB2049		right	XRAC/ST/P/EF/CP1			
ER-6 650 N ABS (ER650E)	650	53 2012 →					FDB2012		ST/P/EF
KL 650 TENGAI	650	1989 → 1992	FDB481			ST/P/EF	FDB314		ST/SG/P/EF
KLR 650	650	1987 → 1994	FDB494			P	FDB314		ST/SG/P/EF
KLR 650	650	1995 → 2005	FDB2048			XRAC/ST/P/EF/CP1	FDB314		ST/SG/P/EF
KLR 650	650	2008 →	FDB497			ST/SM/SG/P/EF	FDB631		ST/SM/SG/P/EF/AG
KLX 650 R	650	1993 → 1997	FDB892			ZR/SG/P/EF/CPRO	FDB659		SG/P/EF
Ninja 650	650	50 2017 →	FDB570	2		XRAC/ST/SM/P/EF/CPRO	FDB754		ST/P/EF
Versys (LE650A)	650	25 2007 → 2009	FDB2048		left	XRAC/ST/P/EF/CP1	FDB2012	left	ST/P/EF
Versys (LE650A)	650	25 2007 → 2009	FDB2049		right	XRAC/ST/P/EF/CP1			
Versys (LE650A)	650	47 2007 → 2009	FDB2048		left	XRAC/ST/P/EF/CP1	FDB2012	left	ST/P/EF
Versys (LE650A)	650	47 2007 → 2009	FDB2049		right	XRAC/ST/P/EF/CP1			
Versys (LE650A)	650	53 2007 → 2009	FDB2048		left	XRAC/ST/P/EF/CP1	FDB2012	left	ST/P/EF
Versys (LE650A)	650	53 2007 → 2009	FDB2049		right	XRAC/ST/P/EF/CP1			
Versys (LE650C)	650	25 2009 → 2013	FDB2048		left	XRAC/ST/P/EF/CP1			
Versys (LE650C)	650	25 2009 → 2013	FDB2049		right	XRAC/ST/P/EF/CP1			
Versys (LE650C)	650	25 2009 → 2013					FDB2012		ST/P/EF
Versys (LE650C)	650	47 2009 → 2013	FDB2048		left	XRAC/ST/P/EF/CP1			
Versys (LE650C)	650	47 2009 → 2013	FDB2049		right	XRAC/ST/P/EF/CP1			
Versys (LE650C)	650	47 2009 → 2013					FDB2012		ST/P/EF
Versys 650 (LE650E) EFF	650	35 2015 →	FDB570	2		XRAC/ST/SM/P/EF/CPRO	FDB2258		ST/EF
Versys 650 ABS (LE650E) FFF	650	35 2015 →	FDB570	2		XRAC/ST/SM/P/EF/CPRO	FDB2258		ST/EF
Versys 650 (LE650E) EGF	650	51 2015 →	FDB570	2		XRAC/ST/SM/P/EF/CPRO	FDB754		ST/P/EF
Versys 650 ABS (LE650E) FGF	650	51 2015 →	FDB570	2		XRAC/ST/SM/P/EF/CPRO	FDB754		ST/P/EF
Vulcan S	650	45 2015 →	FDB2073			ST/SM/P/EF	FDB754		ST/P/EF
W 650	650	1999 →	FDB2049			XRAC/ST/P/EF/CP1	FSB718		
Z 650	650	2017 →	FDB570	2		XRAC/ST/SM/P/EF/CPRO	FDB2258		ST/EF
Z 650 B1 - B3	650	1979 → 1981	FDB132			P	FSB719		
Z 650 C1 - C2 - C3	650	1976 → 1977	FDB132	2		P			

* It is recommended that in those applications where sintered pads are supplied as Original Equipment, replacement pads should also be of sintered composition.

** To avoid brake imbalance sintered pads fitted in rear calipers should only be used in combination with front calipers containing sintered pads.



CC KW FROM -> TO N° SET L/R COMPOUND N° SET L/R COMPOUND

...KAWASAKI

Z 650 D2 - D3	650	1978 → 1981	FDB132	2		P			
Z 650 F1	650	1979 → 1980	FDB132	2		P	FSB719		
Z 650 F2 - F4	650	1980 → 1983	FDB299	2		P	FSB719		
Z 650 SR	650	1978 → 1981	FDB132	2		P			
750 BELT DRIVE	750	1985 → 1987	FDB339	2		ST/P/EF	FDB339		ST/P/EF
GPX 750 BLACKBIRD	750	1988 → 1989	FDB481	2		ST/P/EF	FDB481		ST/P/EF
GPX 750 WARBIRD	750	1988 → 1989	FDB481	2		ST/P/EF	FDB481		ST/P/EF
GPZ 750	750	1985 → 1986	FDB339	2		ST/P/EF	FDB339		ST/P/EF
GPZ 750 R1	750	1985 → 1987	FDB339	2		ST/P/EF	FDB339		ST/P/EF
GPZ 750 R - G2-3	750	1987 →	FDB481	2		ST/P/EF	FDB481		ST/P/EF
GT 750	750	1985 → 1996	FDB299	2		P	FDB298		P
750 TURBO	750	1985 → 1987	FDB339	2		ST/P/EF	FDB339		ST/P/EF
VN 750 TWIN	750	1986 → 1987	FDB339	2		ST/P/EF	FSB719		
VN 750	750	1988 → 1989	FDB339	2		ST/P/EF	FDB339		ST/P/EF
VN 750 VULCAN	750	1990 → 1994	FDB339	2		ST/P/EF	FSB719		
750 VULCAN	750	1989 → 1993	FDB339	2		ST/P/EF	FSB719		
Z 750 SPORT	750	1984 →	FDB299	2		P	FDB298		P
Z 750 B1 - B2	750	1977 → 1978	FDB132	2		P	FDB132		P
Z 750 D1	750	1976 → 1978	FDB132	2		P	FDB132		P
Z 750 E1	750	1980 →	FDB299	2		P	FDB298		P
Z 750 GP	750	1983 →	FDB339	2		ST/P/EF	FDB339		ST/P/EF
Z 750 H1 - H2 LTD	750	1980 →	FDB299	2		P	FDB298		P
Z 750 LTD TWIN K1	750	1983 →	FDB298	2		P	FSB719		
Z 750 L1 - L3	750	1981 →	FDB299	2		P	FDB298		P
Z 750 P1	750	1981 →	FDB299	2		P	FDB298		P
Z 750 P2 SHAFT	750	1981 →	FDB299	2		P	FDB298		P
Z 750 P2 SHAFT GT	750	1981 →	FDB299	2		P	FDB298		P
Z 750 GP R1	750	1982 →	FDB299	2		P	FDB298		P
Z 750 R	750	2011 →	FDB2220	2		XRAC/ST/CPRO/CP1	FDB754		ST/P/EF
Z 750 / Z 750 S	750	2004 → 2006	FDB2048		left	XRAC/ST/P/EF/CP1			
Z 750 / Z 750 S	750	2004 → 2006	FDB2049		right	XRAC/ST/P/EF/CP1			
Z 750 / Z 750 S	750	2004 → 2006					FDB2012		ST/P/EF
Z 750 / Z 750 S	750	2007 →	FDB570	2		XRAC/ST/SM/P/EF/CPRO	FDB754		ST/P/EF
Z 750 Y1 LTD	750	1982 →	FDB299	2		P	FSB719		
ZR 750	750	1991 → 1995	FDB481	2		ST/P/EF	FDB481		ST/P/EF
ZR 750 ZEPHYR	750	1991 → 1993	FDB481	2		ST/P/EF	FDB508		P
ZR 750 ZEPHYR	750	1996 →	FDB2048			XRAC/ST/P/EF/CP1	FDB481		ST/P/EF
ZR-7 750	750	1999 →	FDB2048		left	XRAC/ST/P/EF/CP1			
ZR-7 750	750	1999 →	FDB2049		right	XRAC/ST/P/EF/CP1			
ZR-7 750	750	1999 →					FDB2049		XRAC/ST/P/EF/CP1
ZR-7S 750	750	2001 →	FDB2048		left	XRAC/ST/P/EF/CP1			
ZR-7S 750	750	2001 →	FDB2049		right	XRAC/ST/P/EF/CP1			
ZR-7S 750	750	2001 →					FDB2049		XRAC/ST/P/EF/CP1
ZX 750 E1 TURBO	750	1983 → 1985	FDB339	2		ST/P/EF	FDB339		ST/P/EF
ZX 750 A1	750	1983 → 1985	FDB339	2		ST/P/EF	FDB339		ST/P/EF
ZX 750 F2 NINJA	750	1988 →	FDB481	2		ST/P/EF	FDB481		ST/P/EF
ZX-7 750 R NINJA	750	1989 → 1995	FDB574	2		ZRAC/XRAC/ST/P/EF/CP1	FDB338		ST/P/EF
ZX-7 750 R NINJA	750	1996 → 2003	FDB873	2		ZRAC/XRAC/ST/P/EF/CPRO/CP1	FDB338		ST/P/EF
ZX-7 750 R NINJA (Racing Applications)	750	1996 → 2003	FDB2144	2		XRAC/ST/P	FDB338		ST/P/EF
ZX-7 750 RR NINJA N1	750	1996 → 1999	FDB2036	2		XRAC/ST/P	FDB2111		ST/P/EF
ZXR 750	750	1989 → 1990	FDB574	2		ZRAC/XRAC/ST/P/EF/CP1	FDB338		ST/P/EF
ZXR 750 R STINGER / NINJA	750	1991 → 1992	FDB574	2		ZRAC/XRAC/ST/P/EF/CP1	FDB496		P
ZXR 750 R	750	1993 → 1995	FDB574	2		ZRAC/XRAC/ST/P/EF/CP1	FDB338		ST/P/EF
EJ800 (W 800 all model)	800	2011 →	FDB2049			XRAC/ST/P/EF/CP1	FSB719		
VN 800	800	1995 → 1998	FDB339			ST/P/EF	FSB719		
VN 800 CLASSIC	800	1996 →	FDB2048			XRAC/ST/P/EF/CP1	FSB719		
VN 800 DRIFTER	800	1999 → 2003	FDB2048			XRAC/ST/P/EF/CP1	FDB2049		XRAC/ST/P/EF/CP1
VT 800 C	800	1988 → 1990	FDB244			ST/P/EF	FSB761		
Z 800 (ZR800A)	800	72 2013 →	FDB2158	2		ST	FDB2258		ST/EF
Z 800 (ZR800A)	800	78 2013 →	FDB2158	2		ST	FDB2258		ST/EF
Z 800 (ZR800A)	800	83 2013 →	FDB2158	2		ST	FDB2258		ST/EF
Z 800 ABS (ZR800B)	800	83 2013 →	FDB2158	2		ST	FDB2258		ST/EF
Z 800 Sugomi Ed.	800	2016 →	FDB2158	2		ST	FDB2258		ST/EF
Z 800 e (ZR800C)	800	35 2013 →	FDB570	2		XRAC/ST/SM/P/EF/CPRO	FDB2258		ST/EF
Z 800 e (ZR800C)	800	70 2013 →	FDB570	2		XRAC/ST/SM/P/EF/CPRO	FDB2258		ST/EF
Z 800 e ABS (ZR800D)	800	70 2013 →	FDB2158	2		ST	FDB2258		ST/EF
VN 850	850	1995 → 1999	FDB339			ST/P/EF	FSB719		
GPZ 900 R (ZX900A or NINJA 900)	900	1984 → 1989	FDB339	2		ST/P/EF	FDB339		ST/P/EF
GPZ 900 R	900	1990 → 1996	FDB574	2		ZRAC/XRAC/ST/P/EF/CP1	FDB481		ST/P/EF
KZ 900 B1	900	1976 → 1977	FDB132	2		P			
VN 900 CLASSIC / CUSTOM /LIGHT TOURER	900	2006 →	FDB2048			XRAC/ST/P/EF/CP1	FDB2049		XRAC/ST/P/EF/CP1
X-9 R 900 NINJA	900	1994 → 1995	FDB574	2		ZRAC/XRAC/ST/P/EF/CP1	FDB2012		ST/P/EF
Z 900	900	2017 →	FDB2158	2		ST	FDB2258		ST/EF
Z 900 A 4	900	1977 → 1978	FDB132	2		P	FSB795		

* It is recommended that in those applications where sintered pads are supplied as Original Equipment, replacement pads should also be of sintered composition.

** To avoid brake imbalance sintered pads fitted in rear calipers should only be used in combination with front calipers containing sintered pads.



	CC	KW	FROM -> TO		N° SET	L/R	COMPOUND		N° SET	L/R	COMPOUND
...KAWASAKI											
ZX-9R 900 R NINJA (B1 - B2)	900		1994 → 1995	FDB574	2		ZRAC/XRAC/ST/P/EF/CP1	FDB2012			ST/P/EF
ZX-9R 900 R NINJA (B1 - B2)	900		1996 → 1997	FDB873	2		ZRAC/XRAC/ST/P/EF/CPRO/CP1	FDB2012			ST/P/EF
ZX-9R 900 R NINJA (Racing Applications)	900		1996 → 1997	FDB2144	2		XRAC/ST/P	FDB2012			ST/P/EF
ZX-9R 900 R NINJA (B1 - B2)	900		1998 → 1999	FDB873	2		ZRAC/XRAC/ST/P/EF/CPRO/CP1	FDB2012			ST/P/EF
ZX-9R 900 R NINJA (Racing Applications)	900		1998 → 1999	FDB2144	2		XRAC/ST/P	FDB2012			ST/P/EF
ZX-9R 900 R NINJA (B3 - B4) (C1 - C2) (E1 - E2)	900		2000 → 2001	FDB873	2		ZRAC/XRAC/ST/P/EF/CPRO/CP1	FDB2012			ST/P/EF
ZX-9R 900 R NINJA (Racing Applications)	900		2000 → 2001	FDB2144	2		XRAC/ST/P	FDB2012			ST/P/EF
ZX-9R 900 R NINJA F1-F2	900		2002 → 2004	FDB2158	2		ST	FDB2012			ST/P/EF
Z 900 RS	948	82	2018 →	FDB2178	2		ZRAC/XRAC/ST	FDB2258			ST/EF
Z 900 RS Cafe	948	82	2018 →	FDB2178	2		ZRAC/XRAC/ST	FDB2258			ST/EF
Ninja HR2 Carbon	998		2017 →	FDB2260	2		XRAC/ST/CPRO	FDB2074			ST/SM/P/EF/CPRO/AG
Ninja H2 SX	998	147	2018 →	FDB2178	2		ZRAC/XRAC/ST	FDB497			ST/SM/SG/P/EF
Ninja H2 SX SE	998	147	2018 →	FDB2178	2		ZRAC/XRAC/ST	FDB497			ST/SM/SG/P/EF
Ninja H2 SX SE+	998	147	2019 →	FDB2260	2		XRAC/ST/CPRO	FDB497			ST/SM/SG/P/EF
ZH2	998		2020 →	FDB2265	2		ST/EF/CPRO	FDB754			ST/P/EF
ZX-10RR Ninja	998	149	2017 →	FDB2260	2		XRAC/ST/CPRO	FDB2221			ST/P
ZX-10R 1000 SE Ninja	998	149	2018 →	FDB2260	2		XRAC/ST/CPRO	FDB2221			ST/P
GPX 1000 R	1000		1988 → 1990	FDB481	2		ST/P/EF	FDB481			ST/P/EF
GPZ 1000 RX - RY	1000		1986 →	FDB339	2		ST/P/EF	FDB339			ST/P/EF
GTR 1000	1000		1986 → 1993	FDB339	2		ST/P/EF	FDB339			ST/P/EF
KLZ VERSYS 1000	1000		2012 →	FDB574	2		ZRAC/XRAC/ST/P/EF/CP1	FDB754			ST/P/EF
KLZ VERSYS 1000	1000		2015 →	FDB574	2		ZRAC/XRAC/ST/P/EF/CP1	FDB754			ST/P/EF
KZ 1000 all models	1000		1982 → 1990	FDB298	2		P	FDB298			P
KZ 1000 B1/B2 LTD	1000		1977 → 1978	FDB132	2		P				
NINJA H2	1000	170	2015 →	FDB2260	2		XRAC/ST/CPRO	FDB2074			ST/SM/P/EF/CPRO/AG
NINJA H2R	1000	228	2015 →	FDB2260	2		XRAC/ST/CPRO	FDB2074			ST/SM/P/EF/CPRO/AG
NINJA H2 CARBON	1000	170	2017 →	FDB2260	2		XRAC/ST/CPRO	FDB2074			ST/SM/P/EF/CPRO/AG
VN 1000 VULCAN	1000		1987 →	FDB339	2		ST/P/EF	FDB339			ST/P/EF
Z 1000 LTD	1000		1981 →	FDB299	2		P	FDB298			P
Z 1000	1000		2007 → 2009	FDB2220	2		XRAC/ST/CPRO/CP1	FDB754			ST/P/EF
Z1000 Sugomi Ed.	1000		2016 →	FDB2178	2		ZRAC/XRAC/ST	FDB2012			ST/P/EF
Z 1000 A1 - A4 - H1 - H2	1000		1974 → 1978	FDB132	2		P	FDB151			ST/PR/P
Z 1000 (ZR 1000 A1)	1000		2003 → 2006	FDB2158	2		ST	FDB2012			ST/P/EF
Z 1000 E1 - E2 - SHAFT - ST	1000		1979 → 1981	FDB220	2		ST/P	FDB151			ST/PR/P
Z 1000 GTR (ZG 1000)	1000		1986 → 1993	FDB339	2		ST/P/EF	FDB339			ST/P/EF
Z 1000 GTR	1000		1994 → 2003	FDB481	2		ST/P/EF	FDB339			ST/P/EF
Z 1000 R Edition	1000		2017 →	FDB2260	2		XRAC/ST/CPRO	FDB2012			ST/P/EF
Z 1000 / ABS / SX	1000		2010 →	FDB2178	2		ZRAC/XRAC/ST	FDB2012			ST/P/EF
Z 1000 / SE	1000		2012 →	FDB2220	2		XRAC/ST/CPRO/CP1	FDB2012			ST/P/EF
Z 1000 SX	1000		2012 → 2016	FDB2220	2		XRAC/ST/CPRO/CP1	FDB2012			ST/P/EF
Z 1000 SX	1000		2017 →	FDB2178	2		ZRAC/XRAC/ST	FDB2012			ST/P/EF
ZL 1000 all models	1000		1987 →	FDB339	2		ST/P/EF	FDB339			ST/P/EF
ZX 1000 ELIMINATOR	1000		1988 → 1990	FDB481	2		ST/P/EF	FDB481			ST/P/EF
ZX 1000 RX NINJA - TOMCAT	1000		1988 → 1990	FDB481	2		ST/P/EF	FDB481			ST/P/EF
ZX10 1000 TOMCAT B1-3	1000		1988 → 1990	FDB481	2		ST/P/EF	FDB481			ST/P/EF
ZX-10R 1000	1000	149	2004 → 2007	FDB2164	2		ZRAC/XRAC/ST	FDB2012			ST/P/EF
ZX-10R 1000	1000	149	2008 → 2010	FDB2178	2		ZRAC/XRAC/ST	FDB2012			ST/P/EF
ZX-10R 1000	1000	149	2011 → 2015	FDB2178	2		ZRAC/XRAC/ST	FDB2221			ST/P
ZX-10R Winter test Ed.	1000		2016 →	FDB2260	2		XRAC/ST/CPRO	FDB2221			ST/P
ZX-10R 1000	1000	149	2016 →	FDB2260	2		XRAC/ST/CPRO	FDB2221			ST/P
ZZR 1000	1000		1991 →	FDB574	2		ZRAC/XRAC/ST/P/EF/CP1	FDB481			ST/P/EF
Ninja 1000 SX	1043		2020 →	FDB2178	2		ZRAC/XRAC/ST	FDB2012			ST/P/EF
Versys 1000	1043	88	2019 →	FDB2178	2		ZRAC/XRAC/ST				
Versys 1000	1043	88	2019 →					FDB754	right		ST/P/EF
Versys 1000 SE	1043	88	2019 →	FDB2178	2		ZRAC/XRAC/ST	FDB754			ST/P/EF
GPZ 1100 (ZX 1100 B1-B2)	1100		1982 → 1983	FDB298	2		P	FDB298			P
GPZ 1100 (ZX 1100 A1)	1100		1983 → 1985	FDB339	2		ST/P/EF	FDB339			ST/P/EF
GPZ 1100	1100		1995 → 1997	FDB2048		left	XRAC/ST/P/EF/CP1				
GPZ 1100	1100		1995 → 1997	FDB2049		right	XRAC/ST/P/EF/CP1				
GPZ 1100	1100		1995 → 1997					FDB2012			ST/P/EF
VN 1100	1100		1987 →	FDB339	2		ST/P/EF	FDB339			ST/P/EF
Z 1100 SPECTRE - LTD	1100		1981 → 1983	FDB299	2		P	FDB299			P
Z 1100 A1/3 - B1/2 - F1	1100		1981 → 1983	FDB299	2		P	FDB298			P
Z 1100 GP	1100		1981 → 1983	FDB299	2		P	FDB298			P
Z 1100 R1	1100		1984 →	FDB339	2		ST/P/EF	FDB339			ST/P/EF
Z 1100 ST	1100		1981 → 1983	FDB299	2		P	FDB298			P
ZR 1100 ZEPHYR (ZR 1100 A)	1100		1992 → 1996	FDB574	2		ZRAC/XRAC/ST/P/EF/CP1	FDB481			ST/P/EF
ZR 1100 ZEPHYR	1100		1996 → 1997	FDB2048		left	XRAC/ST/P/EF/CP1				
ZR 1100 ZEPHYR	1100		1996 → 1997	FDB2049		right	XRAC/ST/P/EF/CP1				
ZR 1100 ZEPHYR	1100		1996 → 1997					FDB481			ST/P/EF
ZR 1100 C1	1100		1997 → 2000	FDB873	2		ZRAC/XRAC/ST/P/EF/CPRO/CP1	FDB338			ST/P/EF
ZR 1100 ZEPHIR	1100		1997 → 2000	FDB2048	2		XRAC/ST/P/EF/CP1	FDB481			ST/P/EF
ZRX 1100	1100		1996 → 2000	FDB2036	2		XRAC/ST/P	FDB338			ST/P/EF
ZX 1100	1100		1993 →	FDB574	2		ZRAC/XRAC/ST/P/EF/CP1	FDB481			ST/P/EF

* It is recommended that in those applications where sintered pads are supplied as Original Equipment, replacement pads should also be of sintered composition.

** To avoid brake imbalance sintered pads fitted in rear calipers should only be used in combination with front calipers containing sintered pads.



CC KW FROM -> TO N° SET L/R COMPOUND



N° SET L/R COMPOUND

...KAWASAKI

ZX 1100 A1	1100	1983 → 1984	FDB339	2		ST/P/EF	FDB339		ST/P/EF
ZZR 1100 GT (ZX 1100 C)	1100	1990 → 1992	FDB574	2		ZRAC/XRAC/ST/P/EF/CP1	FDB481		ST/P/EF
ZZR 1100 GT (ZX 1100 D)	1100	1993 → 2001	FDB574	2		ZRAC/XRAC/ST/P/EF/CP1	FDB338		ST/P/EF
KZ 1200	1200	1987 →	FDB339	2		ST/P/EF	FDB339		ST/P/EF
ZG 1200	1200	1986 → 1990	FDB339	2		ST/P/EF	FDB339		ST/P/EF
ZG 1200 VOYAGER	1200	1986 →	FDB339	2		ST/P/EF	FDB339		ST/P/EF
ZRX 1200 R - S	1200	2000 →	FDB481	2		ST/P/EF	FDB338		ST/P/EF
ZRX 1200 R - S	1200	2001 →	FDB873	2		ZRAC/XRAC/ST/P/EF/CPRO/CP1	FDB338		ST/P/EF
ZX 12 1200 R	1200	2000 → 2003	FDB873	2		ZRAC/XRAC/ST/P/EF/CPRO/CP1	FDB338		ST/P/EF
ZX 12 1200 R (Racing Applications)	1200	2000 → 2003	FDB2144	2		XRAC/ST/P	FDB338		ST/P/EF
ZX-12R 1200	1200	2004 →	FDB2164	2		ZRAC/XRAC/ST	FDB338		ST/P/EF
ZZR 1200	1200	2002 →	FDB574	2		ZRAC/XRAC/ST/P/EF/CP1	FDB338		ST/P/EF
KR 1250	1250	1989 →	FDB508	2		P	FDB508		P
Z 1300	1300	1979 → 1983	FDB220	2		ST/P	FDB151		ST/PRP/P
ZG 1300 DF1	1300	1984 → 1986	FDB220	2		ST/P	FDB151		ST/PRP/P
1400 GTR	1400	2007 →	FDB2220	2		XRAC/ST/CPRO/CP1	FDB2111		ST/P/EF
1400 GTR	1400	2015 →	FDB2220	2		XRAC/ST/CPRO/CP1	FDB2111		ST/P/EF
ZZR 1400	1400	2006 →	FDB2220	2		XRAC/ST/CPRO/CP1	FDB2111		ST/P/EF
ZZR 1400	1400	2016 →	FDB2220	2		XRAC/ST/CPRO/CP1	FDB2111		ST/P/EF
ZZR 1400 Performance Sport	1400	2016 →	FDB2260	2		XRAC/ST/CPRO	FDB2111		ST/P/EF
MEAN STREAK 1500	1500	2002 → 2003	FDB873	2		ZRAC/XRAC/ST/P/EF/CPRO/CP1	FDB2049		XRAC/ST/P/EF/CP1
VN 1500 all models	1500	1987 → 1993	FDB339			ST/P/EF	FDB339		ST/P/EF
VN 1500 D1/D2 CLASSIC	1500	1996 → 1998	FDB2048			XRAC/ST/P/EF/CP1	FDB339		ST/P/EF
VN 1500 CLASSIC FI	1500	1999 →	FDB2048			XRAC/ST/P/EF/CP1	FDB2049		XRAC/ST/P/EF/CP1
VN 1500 CLASSIC TOURER	1500	1999 →	FDB2048		left	XRAC/ST/P/EF/CP1			
VN 1500 CLASSIC TOURER	1500	1999 →	FDB2049		right	XRAC/ST/P/EF/CP1			
VN 1500 CLASSIC TOURER	1500	1999 →					FDB339		ST/P/EF
VN 1500 DRIFTER	1500	1999 → 2003	FDB2048			XRAC/ST/P/EF/CP1	FDB2049		XRAC/ST/P/EF/CP1
VN 1600 CLASSIC	1600	2003 →	FDB2048		left	XRAC/ST/P/EF/CP1			
VN 1600 CLASSIC	1600	2003 →	FDB2049		right	XRAC/ST/P/EF/CP1			
VN 1600 CLASSIC	1600	2003 →					FDB2049		XRAC/ST/P/EF/CP1
VN 1600 MEAN STREAK	1600	2004 →	FDB873	2		ZRAC/XRAC/ST/P/EF/CPRO/CP1	FDB2049		XRAC/ST/P/EF/CP1
VN 1600 CLASSIC TOURER	1600	2005 →	FDB2048		left	XRAC/ST/P/EF/CP1			
VN 1600 CLASSIC TOURER	1600	2005 →	FDB2049		right	XRAC/ST/P/EF/CP1			
VN 1600 CLASSIC TOURER	1600	2005 →					FDB2049		XRAC/ST/P/EF/CP1
VN 1700 Classic&Classic Tourer	1700	2009 → 2009	FDB2048		left	XRAC/ST/P/EF/CP1			
VN 1700 Classic&Classic Tourer	1700	2009 → 2009	FDB2049		right	XRAC/ST/P/EF/CP1			
VN 1700 Classic&Classic Tourer	1700	2009 → 2009					FDB2049		XRAC/ST/P/EF/CP1
VN 1700 Voyager (B/BA)	1700	2009 →	FDB574	2		ZRAC/XRAC/ST/P/EF/CP1	FDB2049		XRAC/ST/P/EF/CP1
VN 1700 Classic&Classic Tourer ABS	1700	2010 →	FDB574	2		ZRAC/XRAC/ST/P/EF/CP1	FDB2049		XRAC/ST/P/EF/CP1
VN 1700 Voyager Custom (KB)	1700	2011 →	FDB574	2		ZRAC/XRAC/ST/P/EF/CP1	FDB2049		XRAC/ST/P/EF/CP1
VN 2000 VULCAN / CLASSIC	2000	2004 →	FDB574	2		ZRAC/XRAC/ST/P/EF/CP1	FDB2049		XRAC/ST/P/EF/CP1

KEEWAY

Agora 50 (2T/4T)	50	2010 →	FDB312			ST/P/EF	FSB731		
ARN 50 (25/45)	50	2010 → 2011	FDB207			ST/P/EF/CP1	FSB731		
Easy/Hurricane 50 (25/45)	50	2007 → 2012					FSB731		
F-Act 50	50	2007 → 2010	FDB2191			EF	FSB731		
F-Act 50 EVO (2T)	50	2009 →	FDB2191			EF	FDB313		SG/P/EF
F-Act 50 EVO (4T)	50	2009 →	FDB2191			EF	FSB731		
F-Act-NKD 50	50	2009 → 2011	FDB2191			EF	FSB731		
F-Act- 50 Racing (25/45)	50	2010 → 2012	FDB2191			EF	FSB731		
F-Act- 50 RS	50	2010 → 2011	FDB2191			EF	FSB731		
Flash 50	50	2007 → 2009	FDB313			SG/P/EF	FSB731		
Flash 50 Electric	50	2009 → 2010	FDB2191			EF	FSB731		
Focus 50	50	2006 → 2007	FDB2191			EF	FSB731		
Goccia 50 (2T/4T)	50	2008 →	FDB680			ST/EF	FSB731		
Hacker 50	50	2008 → 2009	FDB207			ST/P/EF/CP1	FSB731		
Hurricane 50	50	2007 →	FDB313			SG/P/EF	FSB731		
Hurricane 50-Base	50	2007 →	FDB313			SG/P/EF	FSB731		
Matrix 50 (2T)	50	2006 → 2012	FDB2191			EF	FSB731		
Matrix V4 50 (25/45)	50	2010 → 2011	FDB2191			EF	FSB731		
Pixel 50	50	2008 → 2012	FDB313			SG/P/EF	FSB731		
RY6 50cc (25/45)	50	2010 →	FDB2191			EF	FSB731		
RY8 50cc (All models)	50	2007 → 2009	FDB2191			EF	FSB731		
RY8 Racing 50cc (25/45)	50	2010 → 2011	FDB2191			EF			
RY8 SP 50cc (25/45)	50	2010 → 2011	FDB2191			EF	FSB731		
Swan 50 (25/45)	50	2010 → 2011	FDB2191			EF	FSB731		
TX50	50	2010 → 2012	FDB677			P/EF	FDB624		AG
X-Ray 50 Supermoto	50	2007 → 2009	FDB677			P/EF	FDB694		ST/AG
50 Zahara (2T/4T)	50	2013 →	FDB312			ST/P/EF	FSB731		
110 Kee	110	2012 →	FDB312			ST/P/EF	FSB733		

* It is recommended that in those applications where sintered pads are supplied as Original Equipment, replacement pads should also be of sintered composition.

** To avoid brake imbalance sintered pads fitted in rear calipers should only be used in combination with front calipers containing sintered pads.



CC KW FROM -> TO N° SET L/R COMPOUND N° SET L/R COMPOUND

...KEEWAY

Partner 110	110	2006 → 2007	FDB497			ST/SM/SG/P/EF			
110 Target	110	2013 →					FSB733		
ARN 125	125	2006 → 2012	FDB207			ST/P/EF/CP1	FSB731		
Cityblade 125	125	2013 →	FDB497			ST/SM/SG/P/EF	FDB2090		P/EF
F-Act 125	125	2007 → 2011	FDB2191			EF	FSB731		
Focus 125	125	2006 → 2007	FDB2191			EF	FSB733		
Hacker 125	125	2008 → 2010	FDB207			ST/P/EF/CP1			
K2 125/150/250	125	2007 →	FDB2142			ST/SM/EF/AG	FDB2142		ST/SM/EF/AG
125 Link	125	2013 →	FDB312			ST/P/EF	FDB312		ST/P/EF
125 Logik	125	2013 →	FDB497			ST/SM/SG/P/EF	FDB497		ST/SM/SG/P/EF
Matrix 125	125	2006 → 2007	FDB313			SG/P/EF	FSB733		
Matrix 125	125	2007 → 2010	FDB2191			EF	FSB733		
125 New Strike	125	2013 →	FSB733				FSB733		
Outlook 125/150	125	2007 → 2010	FDB497			ST/SM/SG/P/EF	FDB497		ST/SM/SG/P/EF
RKS 125	125	2010 → 2011	FDB312			ST/P/EF			
RKS 125	125	2012 →	FDB2087			EF	FSB733		
RKV 125	125	2010 → 2015					FDB2090		P/EF
Silverblade 125/150/250	125	→ 2007	FDB2018	2		ZR/ST/SG/P/EF	FDB2074		ST/SM/P/EF/CPRO/AG
Silverblade 125	125	2010 → 2011	FDB2087			EF	FDB2087		EF
125i Silverblade	125	2013 →					FDB2087		EF
Speed 125/150	125	2007 → 2012	FDB384			P	FDB384		P
125 Strike	125	2013 →	FDB312			ST/P/EF	FSB733		
Superlight 125	125	2007 →	FDB497			ST/SM/SG/P/EF			
125 Target	125	2013 →					FSB733		
TX125	125	2010 → 2012	FDB677			P/EF	FDB694		ST/AG
TX 125 SM (17" F/Wheel)	125	2013 →	FDB677			P/EF	FDB2090		P/EF
125 Zahara (2T/4T)	125	2013 →	FDB312			ST/P/EF	FSB731		
Arn 150	150	2006 → 2009	FDB207			ST/P/EF/CP1	FSB733		
Cityblade 150	150	2013 →	FDB497			ST/SM/SG/P/EF	FDB2057		EF/AG
F-Act 150	150	2007 → 2010	FDB2191			EF	FSB733		
Hacker 150	150	2008 → 2010	FDB207			ST/P/EF/CP1			
150 Link	150	2013 →	FDB312			ST/P/EF	FDB312		ST/P/EF
150 Logik	150	2013 →	FDB497			ST/SM/SG/P/EF	FDB497		ST/SM/SG/P/EF
Matrix 150	150	2007 → 2010	FDB2191			EF	FSB733		
150 New Strike	150	2013 →	FSB733				FSB733		
RKS 150	150	2012 →	FDB2087			EF	FSB733		
RKV 150	150	2013 → 2015					FDB2090		P/EF
RKX 150	150	2013 → 2014					FDB2090		P/EF
150 Strike	150	2013 →	FDB312			ST/P/EF	FSB733		
Superlight 150	150	2007 → 2012	FDB497			ST/SM/SG/P/EF			
KXM 200	200	2014 →	FDB2018			ZR/ST/SG/P/EF	FDB2090		P/EF
KXV 200	200	2014 →	FDB2018			ZR/ST/SG/P/EF	FDB2090		P/EF
200 Link	200	2013 →	FDB312			ST/P/EF	FDB312		ST/P/EF
200 New Strike	200	2013 →	FSB733				FSB733		
RKS 200	200	2012 →	FDB2087			EF	FSB733		
RKV 200 S	200	2014 →					FDB2090		P/EF
RKV 200 S Factory	200	2014 →					FDB2090		P/EF
RKX 200	200	2013 →					FDB2090		P/EF
TX200 (19" F/Wheel)	200	2013 →	FDB677			P/EF	FDB2090		P/EF
250 Blackster	250	2014 →	FDB497			ST/SM/SG/P/EF	FDB631		ST/SM/SG/P/EF/AG
Cruiser 250i	250	2009 →	FDB497			ST/SM/SG/P/EF			
250i Silverblade	250	2013 →					FDB2087		EF
350i Index	350	2013 →	FDB497			ST/SM/SG/P/EF	FDB313		SG/P/EF

KOTIR

RS 50	50	1990 →	FSB731				FSB731		
-------	----	--------	--------	--	--	--	--------	--	--

KRAM IT

ER 125 RV 3	125	1988 →	FDB499			P	FDB731		P
ER 250 RV 3	250	→	FDB499			P	FDB731		P
ER 300 RV 3	300	1988 →	FDB499			P	FDB731		P

KRAMER

80	80	→	FSB834				FSB834		
250	250	→					FSB901		

* It is recommended that in those applications where sintered pads are supplied as Original Equipment, replacement pads should also be of sintered composition.

** To avoid brake imbalance sintered pads fitted in rear calipers should only be used in combination with front calipers containing sintered pads.

1058



CC KW FROM -> TO N° SET L/R COMPOUND



N° SET L/R COMPOUND

KREIDLER

MUSTANG 125	125	1983	→	FDB205			P				
-------------	-----	------	---	--------	--	--	---	--	--	--	--

KSR MOTO BY GENERIC

Epico Electric		2012	→	2013	FDB2191		EF	FSB731			
Cracker 50 (2T/4T)	50	2009	→		FDB2191		EF	FSB731			
Epico 50 (2T)	50	2010	→		FDB2191		EF	FSB731			
Jump 50 (2T)	50	2012	→		FDB313		SG/P/EF	FSB731			
Onyx 50 (2T/All Models)	50	2010	→	2012	FDB680		ST/EF	FSB731			
Race 2 50 (2T/4T)	50	2010	→		FDB2191		EF	FSB731			
50 GT Race Explorer	50	2009	→	2009	FDB2191		EF	FSB731			
Roc 50	50	2008	→	2011	FDB2191		EF	FSB731			
Sirion 50 (2T/4T)	50	2012	→		FDB2191		EF	FSB731			
Toxic 50	50	2007	→	2008	FDB677		P/EF	FDB624			AG
Toxic 50 Sport (2T)	50	2012	→	2012	FDB2191		EF	FSB731			
Vendetta 50 (2T)	50	2012	→		FDB2190		EF	FSB731			
Code S 125/150/200 (4T)	125	2012	→	2015				FDB2090			P/EF
Code X 125/150/200 (4T)	125	2012	→	2014				FDB2090			P/EF
Inox 125 (4T)	125	2012	→		FDB497		ST/SM/SG/P/EF				
Race 2 125 (4T)	125	2010	→		FDB2191		EF	FSB731			
Sirion 125 (4T)	125	2012	→		FDB2191		EF	FSB731			
Trigger 125 SM	125	2008	→	2009	FDB677		P/EF	FDB624			AG
Trigger 125 X	125	2008	→	2009	FDB677		P/EF	FDB624			AG
Vertigo 125	125	2013	→		FDB312		ST/P/EF	FSB731			
Work 125/150 (4T)	125	2012	→		FDB2087		EF				
Zion 125/150 (Rear Drum Model)	125	2008	→	2010	FDB497		ST/SM/SG/P/EF	FBS947			
Zion 125/150 (Rear Disc Model)	125	2011	→	2012	FDB497		ST/SM/SG/P/EF				

KTM

Freeride Electric		2012	→		FDB2262		SG	FDB2257			SG
Freeride E-SM		2015	→		FDB2262		SG	FDB2257			SG
Freeride E-SX		2015	→		FDB2262		SG	FDB2257			SG
Freeride E-XC		2015	→		FDB2262		SG	FDB2257			SG
CHRONO 50 SCOOTER	50	1994	→		FDB498		XRAC/ST/P	FSB704			
COMET 50 PL-RL-RLW-RS4L-TS	50		→		FDB207		ST/P/EF/CP1				
HOBBY-DUO-PRO 50 COMET 40PI-KJ	50		→		FSB814			FSB814			
GO 50 SCOOTER	50	1994	→		FDB697		EF	FSB704			
KROSS 50	50	1996	→		FDB680		ST/EF				
MX 50	50	1987	→		FDB207		ST/P/EF/CP1				
RSV 50	50	1986	→		FDB207		ST/P/EF/CP1				
50 SX/SXR PRO JUNIOR/SENIOR/ADVENTURE	50	1996	→	2003	FSB712			FSB712			
50 SX PRO SENIOR LC	50	2002	→	2003	FDB2183		SG	FSB712			
50 SX SENIOR ADVENTURE	50	2002	→	2007	FDB2183		SG	FSB712			
50 SX MINI ADVENTURE	50	2004	→	2007	FSB712			FSB712			
50 SX PRO SENIOR LC (12" Front Wheel)	50	2004	→		FDB2183		SG	FDB2183			SG
SX 60	60	1998	→	1999	FRP405		ST/SG/PRP/P/EF				
SX 60 / 65	60	2000	→	2001	FRP405		ST/SG/PRP/P/EF	FDB694			ST/AG
SX 65	65	2002	→	2003	FDB2157		SG	FDB694			ST/AG
SX 65	65	2004	→	2009	FDB2157		SG	FDB2183			SG
SX 65	65	2010	→		FDB2157		SG	FDB2157			SG
L-PL-RL-RS-RSL-BORA 80	80		→		FDB207		ST/P/EF/CP1	FDB207			ST/P/EF/CP1
MX 80 GR - SUPER MINI	80	1986	→		FDB207		ST/P/EF/CP1				
SX 85	85	2003	→	2010	FDB2157		SG	FDB2157			SG
SX 85 (17"/14")	85	2011	→		FDB2157		SG	FDB2257			SG
SX 85 (16"/19")	85	2012	→		FDB2262		SG	FDB2257			SG
125	125		→	1983	FSB814			FSB814			
125	125	1989	→	1990	FDB314		ST/SG/P/EF	FDB314			ST/SG/P/EF
125 all models	125	1992	→	1993	FDB2018		ZR/ST/SG/P/EF	FDB2018			ZR/ST/SG/P/EF
BAJA 125	125	1986	→		FDB207		ST/P/EF/CP1				
CROSS 125	125	1980	→	1983	FSB814			FSB814			
125 DUKE	125	11	2010	→	2012	FDB2266	ST/EF	FDB2005			ST/SG/P/EF
125 DUKE ABS	125	11	2013	→		FDB2266	ST/EF	FDB2005			ST/SG/P/EF
125 EXC (2T)	125	1998	→	2003	FDB2018		ZR/ST/SG/P/EF	FDB2005			ST/SG/P/EF
125 EXC (2T)	125	2004	→		FDB2018		ZR/ST/SG/P/EF	FDB2165			SG/P/EF
125 EXC Six Days (2T)	125	2011	→		FDB2018		ZR/ST/SG/P/EF	FDB2165			SG/P/EF
EXE 125	125	2000	→	2003	FDB2018		ZR/ST/SG/P/EF	FDB2005			ST/SG/P/EF
GS 125 XC ENDURO SPORT	125	1986	→	1987	FDB498		XRAC/ST/P	FDB498			XRAC/ST/P
GS 125 XC ENDURO SPORT	125	1986	→	2000	FDB207		ST/P/EF/CP1	FDB207			ST/P/EF/CP1
LC - GS 125 GS	125	1983	→					FSB814			
LC2 125	125	1998	→		FDB2018		ZR/ST/SG/P/EF	FDB2005			ST/SG/P/EF
LC2 STING 125	125	1998	→		FRP408		XRAC/ST/PRP/P/CPRO/CP1	FDB2005			ST/SG/P/EF

* It is recommended that in those applications where sintered pads are supplied as Original Equipment, replacement pads should also be of sintered composition.

** To avoid brake imbalance sintered pads fitted in rear calipers should only be used in combination with front calipers containing sintered pads.



CC KW FROM -> TO N° SET L/R COMPOUND N° SET L/R COMPOUND

...KTM												
CC	KW	FROM ->	TO	N° SET	L/R	COMPOUND	N° SET	L/R	COMPOUND	N° SET	L/R	COMPOUND
MX 125 CROSS	125	1985	→	FDB207		ST/P/EF/CP1						
MX 125 CROSS	125	1986	→	FDB207		ST/P/EF/CP1	FDB207					ST/P/EF/CP1
MX 125 VC CROSS	125	1986	→ 1987	FDB498		XRAC/ST/P	FDB498					XRAC/ST/P
RC 125 (ABS Std)	125	2014	→	FDB2266		ST/EF	FDB2005					ST/SG/P/EF
SX 125	125	1996	→ 2002	FDB2018		ZR/ST/SG/P/EF	FDB2005					ST/SG/P/EF
SX 125	125	2003	→	FDB2018		ZR/ST/SG/P/EF	FDB2165					SG/P/EF
125 XC-W (2T)	125	2018	→	FDB2018		ZR/ST/SG/P/EF	FDB2165					SG/P/EF
SX 150	150	2008	→	FDB2018		ZR/ST/SG/P/EF	FDB2165					SG/P/EF
175	175	1972	→ 1978	FSB814			FSB814					
175	175	1979	→	FSB814			FSB815					
200 DUKE (ABS Std)	200	2013	→	FDB2266		ST/EF	FDB2005					ST/SG/P/EF
EGS 200	200	1998	→	FDB2018		ZR/ST/SG/P/EF	FDB2005					ST/SG/P/EF
200 EXC (2T)	200	1998	→ 2003	FDB2018		ZR/ST/SG/P/EF	FDB2005					ST/SG/P/EF
200 EXC (2T)	200	2004	→	FDB2018		ZR/ST/SG/P/EF	FDB2165					SG/P/EF
RC 200 (ABS Std)	200	2014	→	FDB2266		ST/EF	FDB2005					ST/SG/P/EF
SX 200	200	2003	→	FDB2018		ZR/ST/SG/P/EF	FDB2165					SG/P/EF
250 DUKE	248	22	2015	→	FDB2266	ST/EF	FDB2005					ST/SG/P/EF
250	250	1989	→ 1990	FDB314		ST/SG/P/EF	FDB314					ST/SG/P/EF
BAJA 250	250	1986	→	FDB207		ST/P/EF/CP1						
CROSS 250	250		→ 1981	FSB814			FSB814					
CROSS 250	250	1982	→	FSB815			FSB815					
CROSS 250	250	1983	→	FSB817			FSB815					
250 all models	250	1992	→ 1993	FDB2018		ZR/ST/SG/P/EF	FDB2018					ZR/ST/SG/P/EF
250 all models	250	1994	→ 1995	FDB2018		ZR/ST/SG/P/EF	FDB2005					ST/SG/P/EF
250 EXC (2T)	250	1998	→ 2003	FDB2018		ZR/ST/SG/P/EF	FDB2005					ST/SG/P/EF
250 EXC (2T)	250	2004	→	FDB2018		ZR/ST/SG/P/EF	FDB2165					SG/P/EF
250 EXC-F (4T)	250	2007	→	FDB2018		ZR/ST/SG/P/EF	FDB2165					SG/P/EF
250 EXC Six Days (2T)	250	2011	→	FDB2018		ZR/ST/SG/P/EF	FDB2165					SG/P/EF
250 EXC-F Six Days (4T)	250	2011	→	FDB2018		ZR/ST/SG/P/EF	FDB2165					SG/P/EF
Freeride 250 R	250	2014	→	FDB2262		SG	FDB2257					SG
GS 250 XC ENDURO SPORT	250	1986	→ 1987	FDB498		XRAC/ST/P	FDB498					XRAC/ST/P
GS 250 XC ENDURO SPORT	250	1986	→ 2000	FDB207		ST/P/EF/CP1	FDB207					ST/P/EF/CP1
MX 250 CROSS	250	1985	→	FDB207		ST/P/EF/CP1						
MX 250 CROSS - DIG.CONTR.	250	1986	→	FDB207		ST/P/EF/CP1	FDB207					ST/P/EF/CP1
MX 250 VC CROSS	250	1986	→ 1987	FDB498		XRAC/ST/P	FDB498					XRAC/ST/P
MX 250	250	2003	→	FDB2018		ZR/ST/SG/P/EF	FDB2165					SG/P/EF
Superenduro 250 - S	250	2008	→	FDB2018		ZR/ST/SG/P/EF	FDB2018					ZR/ST/SG/P/EF
SX 250 (2T)	250	1994	→ 2002	FDB2018		ZR/ST/SG/P/EF	FDB2005					ST/SG/P/EF
SX 250 (2T)	250	2003	→	FDB2018		ZR/ST/SG/P/EF	FDB2165					SG/P/EF
SX-F 250 (4T)	250	2006	→	FDB2018		ZR/ST/SG/P/EF	FDB2165					SG/P/EF
300 all models	300	1994	→ 1995	FDB2018		ZR/ST/SG/P/EF	FDB2005					ST/SG/P/EF
300 EXC (2T)	300	2000	→ 2003	FDB2018		ZR/ST/SG/P/EF	FDB2005					ST/SG/P/EF
300 EXC (2T)	300	2004	→	FDB2018		ZR/ST/SG/P/EF	FDB2165					SG/P/EF
300 EXC Six Days (2T)	300	2011	→	FDB2018		ZR/ST/SG/P/EF	FDB2165					SG/P/EF
GS 300 XC ENDURO SPORT	300	1986	→ 1987	FDB498		XRAC/ST/P	FDB498					XRAC/ST/P
GS 300 XC ENDURO SPORT	300	1986	→ 2000	FDB207		ST/P/EF/CP1	FDB207					ST/P/EF/CP1
MX 300	300	2004	→	FDB2018		ZR/ST/SG/P/EF	FDB2165					SG/P/EF
350	350	1989	→ 1990	FDB314		ST/SG/P/EF	FDB314					ST/SG/P/EF
COUNTRY 350 CROSS E	350	1985	→	FDB207		ST/P/EF/CP1						
350 EXC-F (4T)	350	2011	→	FDB2018		ZR/ST/SG/P/EF	FDB2165					SG/P/EF
350 EXC-F Six Days (4T)	350	2012	→	FDB2018		ZR/ST/SG/P/EF	FDB2165					SG/P/EF
Freeride 350	350	2012	→	FDB2262		SG	FDB2257					SG
GS 350 ENDURO SPORT	350	1983	→	FDB207		ST/P/EF/CP1	FDB207					
GS 350 4 STROKE	350	1993	→	FDB2018		ZR/ST/SG/P/EF	FDB314					ST/SG/P/EF
SX-F 350	350	2011	→	FDB2018		ZR/ST/SG/P/EF	FDB2165					SG/P/EF
350 XC-F	350	2011	→	FDB2018		ZR/ST/SG/P/EF	FDB2165					SG/P/EF
350 XCF W	350	2011	→	FDB2018		ZR/ST/SG/P/EF	FDB2165					SG/P/EF
SX 380	380	1998	→	FDB2018		ZR/ST/SG/P/EF	FDB2005					ST/SG/P/EF
390 Adventure	390	2020	→	FDB2266		left	ST/EF					
390 Adventure	390	2020	→				FDB2005				right	ST/SG/P/EF
390 DUKE ABS	390	24	2013	→	FDB2266		ST/EF					ST/SG/P/EF
390 DUKE ABS	390	30	2013	→	FDB2266		ST/EF					ST/SG/P/EF
390 DUKE ABS	390	32	2013	→	FDB2266		ST/EF					ST/SG/P/EF
GS 390 ENDURO SPORT	390	1983	→	FDB207		ST/P/EF/CP1	FSB815					
RC 390 (ABS Std)	390	2014	→	FDB2266		ST/EF	FDB2005					ST/SG/P/EF
THE DUKE 400	400	1994	→ 1998	FRP408		XRAC/ST/PRP/PCPRO/CP1	FDB314					ST/SG/P/EF
EXC 400	400	2006	→	FDB2018		ZR/ST/SG/P/EF	FDB2165					SG/P/EF
LC4 400 E	400	1998	→	FDB2018		ZR/ST/SG/P/EF	FDB2005					ST/SG/P/EF
SXC 400	400	1998	→	FDB2018		ZR/ST/SG/P/EF	FDB2005					ST/SG/P/EF
SX 400	400	2000	→	FDB2018		ZR/ST/SG/P/EF	FDB2005					ST/SG/P/EF
450 EXC (4T)	450	2003	→ 2004	FDB2018		ZR/ST/SG/P/EF	FDB2005					ST/SG/P/EF
450 EXC (4T)	450	2004	→	FDB2018		ZR/ST/SG/P/EF	FDB2165					SG/P/EF
450 EXC Six Days (4T)	450	2011	→	FDB2018		ZR/ST/SG/P/EF	FDB2165					SG/P/EF
MXC 450	450	2003	→	FDB2018		ZR/ST/SG/P/EF	FDB2165					SG/P/EF

* It is recommended that in those applications where sintered pads are supplied as Original Equipment, replacement pads should also be of sintered composition.

** To avoid brake imbalance sintered pads fitted in rear calipers should only be used in combination with front calipers containing sintered pads.



	CC	KW	FROM -> TO		N° SET	L/R	COMPOUND		N° SET	L/R	COMPOUND
...KTM											
450 SMR	450		2007 →	FDB2244			ST		FDB2165		SG/P/EF
SX 450 / F	450		2003 →	FDB2018			ZR/ST/SG/P/EF		FDB2165		SG/P/EF
SX 450 SMR	450		2005 → 2006	FDB2245			ST		FDB2003		ST/SM/P/EF
SX-F 450	450		2007 →	FDB2018			ZR/ST/SG/P/EF		FDB2165		SG/P/EF
MX 495 MC LELEU	495		1982 → 1983	FDB207			ST/P/EF/CP1		FSB815		
500	500		1989 → 1990	FDB314			ST/SG/P/EF		FDB314		ST/SG/P/EF
500 all models	500		1993 → 1993	FDB2018			ZR/ST/SG/P/EF		FDB2018		ZR/ST/SG/P/EF
500 all models	500		1994 → 1995	FDB2018			ZR/ST/SG/P/EF		FDB2005		ST/SG/P/EF
500 CROSS	500		→ 1982	FSB817					FSB815		
500 EXC (4T)	500		1998 → 2011	FDB2018			ZR/ST/SG/P/EF		FDB2005		ST/SG/P/EF
500 EXC (4T)	500		2012 →	FDB2018			ZR/ST/SG/P/EF		FDB2165		SG/P/EF
500 EXC Six Days (4T)	500		2012 →	FDB2018			ZR/ST/SG/P/EF		FDB2165		SG/P/EF
GS 500 K4 ENDURO	500		1983 →	FDB207			ST/P/EF/CP1		FSB815		
MX 500 CROSS	500		1985 →	FDB207			ST/P/EF/CP1				
MX 500 CROSS	500		1986 → 1987	FDB498			XRAC/ST/P		FDB498		XRAC/ST/P
MX 500 CROSS	500		1986 → 2000	FDB207			ST/P/EF/CP1		FDB207		ST/P/EF/CP1
500 XC-W	500		2012 →	FDB2018			ZR/ST/SG/P/EF		FDB2165		SG/P/EF
SX / MX 525	525		2003 →	FDB2018			ZR/ST/SG/P/EF		FDB2165		SG/P/EF
SX 525 SMR	525		2005 →	FDB2245			ST		FDB2003		ST/SM/P/EF
SXC 540	540		1998 →	FDB2018			ZR/ST/SG/P/EF		FDB2005		ST/SG/P/EF
GXE 550	550		1986 → 1987	FDB498			XRAC/ST/P		FDB498		XRAC/ST/P
GXE 550	550		1986 → 2000	FDB207			ST/P/EF/CP1		FDB207		ST/P/EF/CP1
MX 550 LC4	550		1987 →	FDB498			XRAC/ST/P		FDB498		XRAC/ST/P
560 SMR	560		2007 →	FDB2244			ST		FDB2165		SG/P/EF
ENDURO 600 all models	600		1986 → 1987	FDB498			XRAC/ST/P		FDB498		XRAC/ST/P
ENDURO 600 all models	600		1986 → 2000	FDB207			ST/P/EF/CP1		FDB207		ST/P/EF/CP1
GS 600 ENDURO SPORT	600		1985 →	FDB207			ST/P/EF/CP1				
MX 600	600		1992 →	FDB2018			ZR/ST/SG/P/EF		FDB314		ST/SG/P/EF
SC 600	600		1998 →	FDB2018			ZR/ST/SG/P/EF		FDB2005		ST/SG/P/EF
XC-XCE 600 CROSS COUNTRY-BAJA	600		1985 →	FDB207			ST/P/EF/CP1				
ADVENTURE 620 / 625 / 640 R	620		1998 →	FDB2018			ZR/ST/SG/P/EF		FDB2005		ST/SG/P/EF
THE DUKE 620	620		1994 → 1998	FRP408			XRAC/ST/PRP/CPRO/CP1		FDB2005		ST/SG/P/EF
LC4 620 COMPETITION	620		1998 →	FDB2018			ZR/ST/SG/P/EF		FDB2005		ST/SG/P/EF
625 SMC LC4	625		2005 →	FDB2042			ZRAC/XRAC/ST/P/EF/CPRO		FDB2005		ST/SG/P/EF
DUKE 2 640	640		1998 → 1999	FDB2018			ZR/ST/SG/P/EF		FDB2005		ST/SG/P/EF
LC4 640 E	640		1998 →	FDB2018			ZR/ST/SG/P/EF		FDB2005		ST/SG/P/EF
LC4 640 SUPERMOTO	640		1998 →	FDB2018			ZR/ST/SG/P/EF		FDB2005		ST/SG/P/EF
LC4 640 DUKE II	640		2000 →	FDB2042			ZRAC/XRAC/ST/P/EF/CPRO		FDB2005		ST/SG/P/EF
SXC 650	650		2004 →	FDB2018			ZR/ST/SG/P/EF		FDB2005		ST/SG/P/EF
LC4 660 SUPERMOTO	660		2003 →	FDB2042			ZRAC/XRAC/ST/P/EF/CPRO		FDB2005		ST/SG/P/EF
660 SMC	660		2004 →	FDB2042			ZRAC/XRAC/ST/P/EF/CPRO		FDB2005		ST/SG/P/EF
690 DUKE R	690		2010 → 2012	FDB2120	2		ZRAC/XRAC/ST		FDB2005		ST/SG/P/EF
690 DUKE (ABS Std)	690	54	2012 →	FDB2042	2		ZRAC/XRAC/ST/P/EF/CPRO		FDB2005		ST/SG/P/EF
690 DUKE R (ABS Std)	690		2014 →	FDB2260			XRAC/ST/CPRO		FDB2005		ST/SG/P/EF
690 ENDURO R	690	46	2008 →	FDB2006			ST/P/EF		FDB2005		ST/SG/P/EF
LC4 690 SUPERMOTO Prestige	690		2007 →	FDB2120			ZRAC/XRAC/ST		FDB2005		ST/SG/P/EF
690 SM	690		2007 →	FDB2042			ZRAC/XRAC/ST/P/EF/CPRO		FDB2005		ST/SG/P/EF
690 SMC R (ABS Std)	690	55	2013 →	FDB2120			ZRAC/XRAC/ST		FDB2005		ST/SG/P/EF
690 SMR / SMC / DUKE / SupermotoR	690		2008 →	FDB2120	2		ZRAC/XRAC/ST		FDB2005		ST/SG/P/EF
Duke 790 Prototype	790		2017 →	FDB2042	2		ZRAC/XRAC/ST/P/EF/CPRO		FDB2005		ST/SG/P/EF
790 Adventure R Rally	799		2020 →	FDB2042	2		ZRAC/XRAC/ST/P/EF/CPRO				
790 Adventure R Rally	799		2020 →						FDB2018	right	ZR/ST/SG/P/EF
790 Adventure	799	70	2019 →	FDB2042	2		ZRAC/XRAC/ST/P/EF/CPRO		FDB2018		ZR/ST/SG/P/EF
790 Adventure R	799	70	2019 →	FDB2042	2		ZRAC/XRAC/ST/P/EF/CPRO		FDB2018		ZR/ST/SG/P/EF
790 DUKE	799	77	2018 →	FDB2042	2		ZRAC/XRAC/ST/P/EF/CPRO		FDB2005		ST/SG/P/EF
790 DUKE	799	77	2019 →	FDB2042	2		ZRAC/XRAC/ST/P/EF/CPRO		FDB2005		ST/SG/P/EF
890 Duker	890		2020 →	FDB2260	2		XRAC/ST/CPRO				
890 Duker	890		2020 →						FDB2005	right	ST/SG/P/EF
ADVENTURE 950	950		2003 →	FDB2006	2		ST/P/EF		FDB2018		ZR/ST/SG/P/EF
DUKE 950 / 990 / 990 RC8	950		2003 →	FDB2120	2		ZRAC/XRAC/ST		FDB2005		ST/SG/P/EF
950 R SUPERENDURO	950		2006 → 2008	FDB2006			ST/P/EF		FDB2018		ZR/ST/SG/P/EF
SUPERMOTO 950	950		2005 →	FDB2120	2		ZRAC/XRAC/ST		FDB2018		ZR/ST/SG/P/EF
990 ADVENTURE ABS	990		2008 →	FDB2006	2		ST/P/EF		FDB2018		ZR/ST/SG/P/EF
990 ADVENTURE R	990		2008 →	FDB2006	2		ST/P/EF		FDB2018		ZR/ST/SG/P/EF
990 SMR	990		2008 → 2009	FDB2120	2		ZRAC/XRAC/ST		FDB2018		ZR/ST/SG/P/EF
990 SMT	990		2009 →	FDB2120	2		ZRAC/XRAC/ST		FDB2018		ZR/ST/SG/P/EF
990 SMR	990		2010 →	FDB2260	2		XRAC/ST/CPRO		FDB2018		ZR/ST/SG/P/EF
990 SUPERDUKE	990		2005 → 2011	FDB2120	2		ZRAC/XRAC/ST		FDB2005		ST/SG/P/EF
990 SUPERDUKE R	990		2007 →	FDB2120	2		ZRAC/XRAC/ST		FDB2005		ST/SG/P/EF
1050 ADVENTURE (ABS Std)	1050		2015 →	FDB2042	2		ZRAC/XRAC/ST/P/EF/CPRO		FDB2018		ZR/ST/SG/P/EF
1090 ADVENTURE	1050	92	2017 →	FDB2042	2		ZRAC/XRAC/ST/P/EF/CPRO		FDB2018		ZR/ST/SG/P/EF
1090 ADVENTURE R	1050	92	2017 →	FDB2042	2		ZRAC/XRAC/ST/P/EF/CPRO		FDB2018		ZR/ST/SG/P/EF
1190 ADVENTURE (ABS Std)	1190		2013 →	FDB2042	2		ZRAC/XRAC/ST/P/EF/CPRO		FDB2018		ZR/ST/SG/P/EF
1190 ADVENTURE R (ABS Std)	1190		2013 →	FDB2042	2		ZRAC/XRAC/ST/P/EF/CPRO		FDB2018		ZR/ST/SG/P/EF

KTM

* It is recommended that in those applications where sintered pads are supplied as Original Equipment, replacement pads should also be of sintered composition.

** To avoid brake imbalance sintered pads fitted in rear calipers should only be used in combination with front calipers containing sintered pads.



CC KW FROM -> TO N° SET L/R COMPOUND

N° SET L/R COMPOUND

...KTM

1190 RC8	1190	2008 → 2011	FDB2260	2		XRAC/ST/CPRO	FDB2074			ST/SM/P/EF/CPRO/AG
1190 RC8 R (ABS Std)	1190	2009 →	FDB2260	2		XRAC/ST/CPRO	FDB2074			ST/SM/P/EF/CPRO/AG
SUPERDUKE R 1290 SP Ed.	1290	2017 →	FDB2260	2		XRAC/ST/CPRO	FDB2074			ST/SM/P/EF/CPRO/AG
1290 SUPER ADVENTURE	1300	2015 →	FDB2042	2		ZRAC/XRAC/ST/P/EF/CPRO	FDB2018			ZR/ST/SG/P/EF
1290 SUPER ADVENTURE T	1300	2017 →	FDB2042	2		ZRAC/XRAC/ST/P/EF/CPRO	FDB2018			ZR/ST/SG/P/EF
1290 SUPER ADVENTURE R	1300	118 2017 →	FDB2042	2		ZRAC/XRAC/ST/P/EF/CPRO	FDB2018			ZR/ST/SG/P/EF
1290 SUPER ADVENTURE S	1300	118 2017 →	FDB2042	2		ZRAC/XRAC/ST/P/EF/CPRO	FDB2018			ZR/ST/SG/P/EF
SUPERDUKE R 1290 (ABS Std)	1301	130 2014 →	FDB2260	2		XRAC/ST/CPRO	FDB2074			ST/SM/P/EF/CPRO/AG
SUPERDUKE SE 1290	1301	2016 →	FDB2260	2		XRAC/ST/CPRO	FDB2074			ST/SM/P/EF/CPRO/AG
SUPERDUKE GT 1290	1301	127 2016 →	FDB2260	2		XRAC/ST/CPRO	FDB2074			ST/SM/P/EF/CPRO/AG

KYMCO

Like 125 EV	3	2020 →	FDB497		left	ST/SM/SG/P/EF				
ACTIV 50	50	2005 → 2006	FDB2087			EF	FSB704			
ACTIV 50 SR	50	2008 → 2011	FDB312			ST/P/EF	FSB704			
AGILITY 50 (KG10SA)	50	2005 → 2008	FDB2305			EF	FSB704			
AGILITY 50 R10 (4T)	50	2006 →	FDB2305			EF	FSB704			
AGILITY 50 R12 (4T)	50	2006 →	FDB2305			EF	FSB704			
AGILITY 50 Basic	50	2007 → 2007	FSB704				FSB704			
AGILITY CITY 50 R16 (4T/2T)	50	2008 →	FDB2096			SG/EF	FSB958			
AGILITY RS Naked 50 2T	50	2010 →	FDB2305			EF	FSB704			
AGILITY Carry 50 (4T)	50	2011 → 2018	FDB2096			SG/EF	FSB704			
AGILITY 50 R16 + (2T)	50	2015 →	FDB2096			SG/EF	FSB958			
AGILITY 50 R16 + (4T)	50	2015 →	FDB2096			SG/EF	FSB958			
Agility City + 50 i (4T)	50	2 2019 →	FDB497			ST/SM/SG/P/EF				
Agility RS Naked (4T)	50	2 2019 →	FDB2305			EF				
BET & WIN 50	50	2002 → 2006	FDB2087			EF	FSB704			
COBRA 50 / RACER & CROSS	50	1999 → 2006	FDB672			EF	FSB704			
CURIO 50	50	1994 →	FDB672			EF	FSB704			
CX 50	50	1993 →	FSB704				FSB714			
CX 50 SUPER	50	1994 → 1997	FDB672			EF	FSB714			
DINK / GRAND DINK 50 / New Dink	50	1997 →	FDB2087			EF	FSB704			
DINK 50 (4T)	50	2007 →	FDB2087			EF	FSB704			
DJX 50	50	1991 → 1992	FSB704				FSB714			
DJY 50 / DJY 50 REFINED	50	1993 →	FSB704				FSB714			
DJW 50	50	1994 →	FSB704				FSB714			
DJS 50	50	2012 → 2013	FDB2096			SG/EF	FSB704			
FILLY 50	50	1998 → 2000	FSB704				FSB704			
FILLY LX 50	50	2000 →	FDB497			ST/SM/SG/P/EF	FSB704			
GRAND DINK 50 (2T)	50	2004 → 2007	FDB2087			EF	FSB704			
G-DINK 50 (2T)	50	2012 →	FDB2087			EF	FSB704			
HEROISM 50	50	1995 → 1997	FDB2191			EF	FSB704			
JETIX 50	50	2010 → 2010	FDB312			ST/P/EF	FDB2087			EF
KB 50	50	1994 → 2000	FDB672			EF	FSB704			
K 12 50	50	1995 →	FDB672			EF	FSB704			
LIKE LX 50 2T/4T	50	2010 →	FDB497			ST/SM/SG/P/EF	FSB704			
MANBOY 50	50	1995 →	FDB2192			AG	FSB704			
NEWSENTO 50i (4T)	50	2017 →	FDB497			ST/SM/SG/P/EF				
NEXXON 50	50	2008 → 2009	FDB312			ST/P/EF	FDB312			ST/P/EF
PEOPLE 50 (2T)	50	1999 → 2011	FDB2096			SG/EF	FSB958			
PEOPLE S 50 (2T)	50	2005 → 2010	FDB2096			SG/EF	FSB958			
PEOPLE S 50 ELEGANCE (4T)	50	2006 → 2013	FDB2096			SG/EF	FSB958			
SCOUT 50	50	1998 →	FDB672			EF	FSB704			
SENTO 50	50	2008 → 2009	FDB2087			EF	FSB704			
SNIPER 50 DD	50	1994 → 1996	FDB672			EF	FDB2101			AG
SPACER 50	50	1999 →	FDB2087			EF	FSB704			
SUPER 9 50	50	1999 → 2000	FDB539			SG/P/EF				
SUPER 9 50 LC / SUPER 9 S	50	2000 →	FDB2087			EF	FDB2096			SG/EF
SUPER 8 50 2T/4T	50	2007 →	FDB2096			SG/EF	FSB958			
TOP BOY 50	50	1997 → 2000	FDB2087			EF	FSB704			
TOP BOY 50	50	2000 →	FDB672			EF	FSB704			
VISA R	50	2011 → 2012	FDB314			ST/SG/P/EF	FSB704			
VITALITY 50 (2T & 4T)	50	2004 → 2009	FDB497			ST/SM/SG/P/EF	FSB704			
YUP 50	50	2001 → 2006	FDB497			ST/SM/SG/P/EF				
ZX 50 FEVER	50	1995 →	FDB672			EF	FSB714			
ZK 50 SUPERFEVER	50	1999 →	FDB672			EF	FSB714			
SP 90 YUP	90	1995 →	FDB2192			AG				
COBRA 100 RACER	100	1999 → 2003	FDB497			ST/SM/SG/P/EF	FSB704			
TOP BOY 100	100	1997 →	FDB2087			EF	FSB704			
VISA R 110	110	2011 → 2011	FDB314			ST/SG/P/EF	FSB704			
LIBERO 111 4T	111	2008 →	FDB2087			EF	FSB704			
ACTIV 110 / 125	125	2004 → 2006	FDB2087			EF	FSB704			

* It is recommended that in those applications where sintered pads are supplied as Original Equipment, replacement pads should also be of sintered composition.

** To avoid brake imbalance sintered pads fitted in rear calipers should only be used in combination with front calipers containing sintered pads.



CC KW FROM -> TO N° SET L/R COMPOUND



N° SET L/R COMPOUND

				...KYMCO							
CC	KW	FROM -> TO	N° SET	L/R	COMPOUND	N° SET	L/R	COMPOUND	N° SET	L/R	COMPOUND
AGILITY 125	125	2006 → 2008	FDB2305		EF	FSB704					
AGILITY 125 R12 (4T)	125	2006 →	FDB2305		EF	FSB958					
AGILITY CITY 125 R16	125	7 2008 →	FDB2096		SG/EF	FDB314					ST/SG/P/EF
AGILITY CITY E4	125	2008 →	FDB2256		EF	FDB314					ST/SG/P/EF
AGILITY RS 125 R12 (2T)	125	2009 → 2013	FDB2096		SG/EF	FSB958					
AGILITY RS 125 R12 (4T)	125	2010 →	FDB2305		EF	FSB958					
AGILITY RS 125 R12 (4T) Naked +	125	2010 →	FDB2305		EF	FSB958					
AGILITY Carry 125 (4T)	125	2011 → 2016	FDB2096		SG/EF	FSB704					
AGILITY 125 R16 +	125	7 2015 →	FDB2256		EF	FDB2087					EF
AGILITY Carry 125 (4T) EURO4	125	2017 →	FDB2256		EF	FDB2087					EF
AGILITY City +125 i CBS	125	6 2019 →	FDB2256		EF	FDB2087					EF
B & W 125 BET & WIN Dinksport	125	2000 →	FDB2087		EF	FDB2087					EF
Capture 125	125	2010 →	FDB497		ST/SM/SG/P/EF	FSB958					
CK1 125	125	2014 →	FDB2087		EF	FSB966					
DINK / GRAND DINK 125 /New Dink	125	1997 →	FDB2087		EF	FDB2087					EF
DINK 125 (4T)	125	2006 →	FDB2087		EF	FDB2087					EF
DOWNTOWN 125 i (Super Dink V21000)	125	2009 → 2011	FDB570		XRAC/ST/SM/P/EF/CPRO	FDB2248					EF
DOWNTOWN 125 i ABS (Super Dink V21000)	125	11 2011 → 2014	FDB570		XRAC/ST/SM/P/EF/CPRO	FDB2248					EF
DOWNTOWN 125 i ABS	125	2015 →	FDB2105		EF/AG	FDB2248					EF
EGO 125	125	2001 → 2003	FDB2087		EF	FDB2087					EF
FREEWAY 125	125	1997 →	FSB704			FSB704					
GRAND DINK 125 (4T)	125	2001 → 2007	FDB2087		EF	FDB2087					EF
G-DINK 125i	125	2012 →	FDB570		XRAC/ST/SM/P/EF/CPRO	FDB2254					EF
GRAND DINK 125 E4	125	2016 →	FDB2105		EF/AG	FDB2248					EF
HEROISM 125	125	1995 → 1997	FDB2191		EF	FSB704					
HIPSTER 125	125	1999 →	FDB2087		EF	FSB755					
JETIX 125	125	2010 → 2010	FDB312		ST/P/EF	FDB2087					EF
KR 125 QUANNON SPORT	125	2007 → 2013	FDB2087		EF	FDB2087					EF
KR 125 QUANNON NAKED	125	2010 →	FDB2087		EF	FDB2087					EF
K-PIPE 125	125	2012 → 2013	FDB2087		EF	FSB755					
K-XCT 125i	125	2012 →	FDB2105		EF/AG	FDB2254					EF
LIKE LX 125 4T	125	2010 →	FDB497		ST/SM/SG/P/EF	FDB631					ST/SM/SG/P/EF/AG
LIKE II 125 i ABS Exclusive	125	6 2017 →	FDB2305		EF	FDB2254					EF
LIKE II 125 i CBS	125	6 2018 →	FDB2256		EF	FDB2254					EF
Like 125 S	125	8 2020 →	FDB2256		left EF						
Like 125 S	125	8 2020 →				FDB2254			right		EF
MILER 4T	125	2017 →	FDB2256		EF						
MOVIE 125	125	1998 → 2000	FDB497		ST/SM/SG/P/EF	FSB958					
MOVIE XL 125	125	2001 → 2009	FDB2087		EF	FSB958					
NEXXON 125	125	2007 → 2008	FDB312		ST/P/EF	FDB312					ST/P/EF
PEOPLE 125	125	7 1999 → 2005	FDB2096		SG/EF	FSB958					
PEOPLE S 125	125	2005 → 2006	FDB2096		SG/EF	FSB958					
PEOPLE / PEOPLE S 125	125	2006 →	FDB2096		SG/EF	FDB2254					EF
PEOPLE S 125 DD	125	2007 →	FDB2096		SG/EF	FDB2254					EF
PEOPLE GT 125i	125	2010 →	FDB2105		EF/AG	FDB2254					EF
PEOPLE ONE 125i	125	2013 → 2014	FDB2096		SG/EF	FSB958					
PEOPLE ONE 125i	125	2015 →	FDB2256		EF						
PEOPLE S 125 4T (4V)	125	2017 →	FDB497		ST/SM/SG/P/EF	FDB2248					EF
People GT 125 i CBS	125	21 2019 →	FDB2105		EF/AG	FDB2254					EF
PULSAR 125	125	1999 → 2013	FDB312		ST/P/EF	FSB755					
Racing 125 Fi	125	2010 → 2015	FDB2248		EF	FSB958					
SECTOR 125	125	1998 → 2001	FDB2087		EF						
SPACER 125	125	1998 →	FDB2087		EF	FDB2087					EF
SPIKE 125	125	2004 →	FDB2087		EF	FDB2087					EF
STRYKER 125	125	2001 → 2006	FDB497		ST/SM/SG/P/EF	FSB755					
SUPER 8 125	125	2008 → 2013	FDB2096		SG/EF	FSB958					
Visar 125 i CBS	125	7 2019 →	FDB2105		EF/AG	FDB2087					EF
VIVIO 125	125	2000 → 2003	FDB497		ST/SM/SG/P/EF	FSB958					
X-TOWN 125i ABS	125	2016 →	FDB2105		EF/AG	FDB2254					EF
X-Town CT 125	125	11 2020 →	FDB2105		right EF/AG	FDB2254			right		EF
YAGER 125	125	2001 →	FDB2087		EF	FDB2087					EF
ZING 125 / ZING II 125	125	1997 → 2013	FDB2087		EF	FSB755					
AGILITY CITY 150 R16	150	2008 → 2012	FDB2096		SG/EF	FDB2087					EF
B & W 150 BET & WIN	150	2000 →	FDB2087		EF	FDB2087					EF
DINK 150	150	1997 → 2004	FDB2087		EF	FDB2087					EF
FREEWAY 150	150	1997 →	FSB704			FSB704					
GRAND DINK 150	150	2001 → 2007	FDB2087		EF	FDB2087					EF
HEROISM 150	150	1995 → 1997	FDB2191		EF	FSB704					
HIPSTER 150	150	1999 →	FDB2087		EF	FSB755					
MOVIE XL 150	150	2001 → 2009	FDB2087		EF	FSB958					
PEOPLE 150	150	1999 →	FDB2096		SG/EF	FSB958					
PEOPLE S 150 4T (4V)	150	10 2017 →				FDB2248					EF
PEOPLE S 150 4T (4V)	150	10 2018 →	FDB497		ST/SM/SG/P/EF						
Racing 150Fi	150	2010 → 2014	FDB2248		EF	FSB958					

KYMCO

* It is recommended that in those applications where sintered pads are supplied as Original Equipment, replacement pads should also be of sintered composition.

** To avoid brake imbalance sintered pads fitted in rear calipers should only be used in combination with front calipers containing sintered pads.



CC KW FROM -> TO N° SET L/R COMPOUND



N° SET L/R COMPOUND

...KYMCO

SPACER 150	150	2003	→	FDB2087			EF	FDB2087		EF
STRAIGHT 150	150	2008	→	FDB312			ST/P/EF	FDB312		ST/P/EF
STRYKER 150 (Off-Road)	150	2000	→ 2006	FDB2305			EF	FSB755		
Super 8	150	2007	→ 2014	FDB2096			SG/EF	FSB958		
Vivio 150	150	2000	→ 2003	FDB2305			EF	FSB958		
YAGER 150	150	2001	→	FDB2087			EF	FSB958		
AGILITY 200 i R16	200	8	2010	→	FDB2096		SG/EF	FDB2087		EF
AGILITY 200 i R16 +	200	2015	→	FDB2096			SG/EF	FDB2087		EF
DINK 200i	200	2006	→	FDB2087			EF	FDB2087		EF
DOWNTOWN 200 i (Super Dink V22000)	200	2010	→	FDB570			XRAC/ST/SM/P/EF/CPRO	FDB2248		EF
LIKE LX 200 i	200	2010	→	FDB497			ST/SM/SG/P/EF	FDB631		ST/SM/SG/P/EF/AG
PEOPLE S 200	200	2004	→ 2010	FDB2096			SG/EF	FSB958		
PEOPLE S 200 i	200	2007	→	FDB2096			SG/EF	FDB2254		EF
PEOPLE GTi 200	200	2010	→	FDB2105			EF/AG	FDB2254		EF
SPACER	200	2004	→	FDB2087			EF	FDB2087		EF
YAGER 200i	200	2007	→ 2013	FDB2087			EF	FDB2087		EF
B & W 250 BET & WIN	250	2000	→	FDB2087			EF	FDB2087		EF
EGO 250	250	2001	→	FDB2087			EF	FDB2087		EF
GRAND DINK 250	250	2001	→	FDB2141			SG/EF	FDB2140		AG
PEOPLE 250	250	2003	→ 2005	FDB2087			EF	FDB2225		SM/EF
PEOPLE 250 S	250	2006	→ 2008	FDB497		left	ST/SM/SG/P/EF			
PEOPLE 250 S	250	2006	→ 2008	FDB631		right	ST/SM/SG/P/EF/AG			
PEOPLE 250 S	250	2006	→ 2008					FDB2254		EF
VENOX 250	250	2000	→	FDB664			ST/P/EF	FSB711		
XCITING 250	250	2005	→ 2006	FDB570			XRAC/ST/SM/P/EF/CPRO	FDB2254		EF
XCITING 250	250	2006	→ 2008	FDB570	2		XRAC/ST/SM/P/EF/CPRO	FDB2254		EF
YUP 250	250	2003	→	FDB2087			EF	FDB2087		EF
Agility 300	276	17	2019	→	FDB2248		EF	FDB2254		EF
AGILITY maxi 300i ABS	300	2015	→	FDB2105			EF/AG	FDB2184		SG/P
DOWNTOWN 300 i (V2)	300	22	2009	→ 2012	FDB570		XRAC/ST/SM/P/EF/CPRO	FDB2248		EF
DOWNTOWN 300 i ABS (V2)	300	22	2010	→	FDB570		XRAC/ST/SM/P/EF/CPRO	FDB2248		EF
G-DINK 300i	300	2012	→	FDB570			XRAC/ST/SM/P/EF/CPRO	FDB2254		EF
G-DINK 300i ABS	300	16	2016	→	FDB570		XRAC/ST/SM/P/EF/CPRO	FDB2254		EF
K-XCT 300i /ABS	300	2012	→	FDB2105			EF/AG	FDB2254		EF
PEOPLE S 300 i	300	2008	→ 2010	FDB497		left	ST/SM/SG/P/EF			
PEOPLE S 300 i	300	2008	→ 2010	FDB631		right	ST/SM/SG/P/EF/AG			
PEOPLE S 300 i	300	2008	→ 2010					FDB631		ST/SM/SG/P/EF/AG
PEOPLE GTi 300	300	2010	→	FDB2105			EF/AG	FDB2254		EF
PEOPLE S 300 i	300	2018	→	FDB2105			EF/AG	FDB2254		EF
X-TOWN 300i ABS	300	2016	→	FDB2105			EF/AG	FDB2254		EF
X-Town CT 300	300	17	2020	→	FDB2105		right EF/AG	FDB2254		right EF
XCITING 300 i	300	2008	→	FDB570	2		XRAC/ST/SM/P/EF/CPRO	FDB2254		EF
XCITING 300 i R	300	2008	→	FDB570	2		XRAC/ST/SM/P/EF/CPRO	FDB2254		EF
DOWNTOWN 350 i ABS	350	22	2015	→	FDB2105		EF/AG	FDB2254		EF
XCITING 400 i	400	26	2013	→	FDB2322	2	SM	FDB2288		EF
XCITING 400 i ABS	400	2014	→	FDB2322	2		SM	FDB2288		EF
XCITING 400 i R	400	2015	→	FDB2322	2		SM	FDB2288		EF
XCITING 400 i S	400	26	2018	→	FDB2322	2	SM	FDB2288		EF
XCITING 500 (T70000)	500	2005	→	FDB570	2		XRAC/ST/SM/P/EF/CPRO	FDB2288		EF
XCITING 500 i (T20020)	500	2006	→ 2008	FDB570	2		XRAC/ST/SM/P/EF/CPRO	FDB2288		EF
XCITING 500 i R (T70030)	500	2007	→	FDB570	2		XRAC/ST/SM/P/EF/CPRO	FDB2288		EF
XCITING 500 Ri (T70021)	500	2009	→	FDB570	2		XRAC/ST/SM/P/EF/CPRO	FDB2288		EF
XCITING 500 i EVO ABS	500	2012	→	FDB570	2		XRAC/ST/SM/P/EF/CPRO	FDB2288		EF
AK 550	550	39	2017	→	FDB2265	2	ST/EF/CPRO	FDB2304		EF
MYROAD 700	700	2009	→	FDB570	2		XRAC/ST/SM/P/EF/CPRO	FDB2288		EF

LAMBRETTA

LJ 50	50	2012	→ 2013	FDB2190			EF			
LT 50	50	2012	→ 2013	FDB2190			EF			
50 N Pato	50	2008	→ 2010	FDB312			ST/P/EF	FDB312		ST/P/EF
LN 125 (4T)	125	2011	→ 2013	FDB2190			EF			
125 N Pato	125	2008	→ 2010	FDB312			ST/P/EF	FDB312		ST/P/EF
LN 151 (4T)	150	2011	→ 2013	FDB2190			EF			
151 N Pato	150	2008	→ 2010	FDB312			ST/P/EF	FDB312		ST/P/EF

LAVERDA

OR 50 ATLAS	50	1987	→	FDB207			ST/P/EF/CP1	FDB207		ST/P/EF/CP1
125	125		→ 1982	FDB207			ST/P/EF/CP1	FSB876		
125 (Brembo caliper)	125	1982	→	FDB694			ST/AG	FSB876		
125 (Grimeca caliper)	125	1982	→					FSB876		

* It is recommended that in those applications where sintered pads are supplied as Original Equipment, replacement pads should also be of sintered composition.

** To avoid brake imbalance sintered pads fitted in rear calipers should only be used in combination with front calipers containing sintered pads.



CC KW FROM -> TO  N° SET L/R COMPOUND



N° SET L/R COMPOUND

...LAVERDA

GS 125 LESMO	125	1986 →	FDB207	2		ST/P/EF/CP1	FDB207	ST/P/EF/CP1
GS 125 LESMO	125	1990 →	FDB694			ST/AG	FDB694	ST/AG
LB 125 CUSTOM	125	→	FDB694			ST/AG	FSB876	
LB 125 STRADA	125	→	FDB694			ST/AG	FSB876	
LB 125 UNO	125	→	FDB694			ST/AG	FSB876	
PHOENIX 125 / 150 / 200	125	2001 →	FDB2108			EF	FDB2096	SG/EF
350	350	1980 →	FDB207	2		ST/P/EF/CP1	FDB207	ST/P/EF/CP1
ALPINO 500	500	1977 →	FDB207	2		ST/P/EF/CP1	FDB207	ST/P/EF/CP1
PF 500	500	1977 →	FDB207	2		ST/P/EF/CP1	FDB207	ST/P/EF/CP1
RS 500	500	1977 →	FDB207	2		ST/P/EF/CP1	FDB207	ST/P/EF/CP1
SFC 500	500	1977 →	FDB108	2		ST/P/EF/CPRO	FDB108	ST/P/EF/CPRO
CR 600 CRUISER	600	1987 →	FDB499			P		
OR 600	600	1986 →	FDB207			ST/P/EF/CP1	FDB592	P
OR 600 ATLAS	600	1987 →	FDB592	2		P		
650 (all models)	650	1995 → 1996	FRP408	2		XRAC/ST/PRP/PI/CPRO/CP1	FDB207	ST/P/EF/CP1
LYNX 650	650	2000 →	FRP408	2		XRAC/ST/PRP/PI/CPRO/CP1	FDB207	ST/P/EF/CP1
GHOST - DIAMANTE 668	668	1997 → 1998	FRP408	2		XRAC/ST/PRP/PI/CPRO/CP1	FDB207	ST/P/EF/CP1
CUP 750	750	1998 →	FRP408	2		XRAC/ST/PRP/PI/CPRO/CP1	FDB207	ST/P/EF/CP1
DIAMANTE 750	750	1997 →	FRP408	2		XRAC/ST/PRP/PI/CPRO/CP1	FDB207	ST/P/EF/CP1
750 S (all models)	750	1999 →	FRP408	2		XRAC/ST/PRP/PI/CPRO/CP1	FDB207	ST/P/EF/CP1
SF3 750	750	1977 →	FDB148	2		ST/P	FDB148	ST/P
TTS 800	800	1999 →	FRP408	2		XRAC/ST/PRP/PI/CPRO/CP1	FDB2074	ST/SM/P/EF/CPRO/AG
JOTA 1000	1000	1995 →	FRP408	2		XRAC/ST/PRP/PI/CPRO/CP1	FDB207	ST/P/EF/CP1
RGA 1000	1000	→	FDB148	2		ST/P	FDB148	ST/P
RGA 1000 JOTA	1000	→	FDB148	2		ST/P	FDB148	ST/P
RGS 1000 CORSA	1000	→	FDB148	2		ST/P	FDB148	ST/P
RGS 1000 EXECUTIVE	1000	→	FDB148	2		ST/P	FDB148	ST/P
RGS 1000 JOTA	1000	1977 →	FDB148	2		ST/P	FDB148	ST/P
SFC 1000	1000	1986 →	FDB108	2		ST/P/EF/CPRO	FDB108	ST/P/EF/CPRO
SFC 1000	1000	2003 →	FDB2120	2		ZRAC/XRAC/ST	FDB2074	ST/SM/P/EF/CPRO/AG
T.T. 1200	1200	1976 →	FDB148	2		ST/P	FDB148	ST/P

LEM

FLASH 50	50	1994 →	FDB828			ST/P	FSB731	
GIBLI 50	50	1990 →	FSB731				FSB731	
R2 / R3	50	2003 →	FDB2183			SG	FDB2183	SG

LIFAN

Smart 50/125	125	→	FDB2169			P/EF		
--------------	-----	---	---------	--	--	------	--	--

LIGIER

NOVA	500	2001 →	FDB2153			P		
------	-----	--------	---------	--	--	---	--	--

LINHAI

LH 50 Prince (Scooter)	50	2007 →	FDB383			SG/P/EF		
Eggy 125 (Scooter)	125	2007 →	FDB383			SG/P/EF		
Monarch 125 T	125	2006 →	FDB2003			ST/SM/P/EF	FDB2083	ST/SM/P/EF
Monarch 150 T	150	2006 →	FDB2003			ST/SM/P/EF	FDB2083	ST/SM/P/EF
Main Street 300 (Scooter)	300	2007 →	FDB2003			ST/SM/P/EF	FDB2083	ST/SM/P/EF

LML

Star Deluxe 125 (2T/Disc model)	125	2001 → 2003	FDB784			EF/AG	FSB874	
Star 125 (2T) All Models	125	2010 → 2014	FDB784			EF/AG	FSB874	
Star 125i (4T) All Models	125	2010 →	FDB784			EF/AG	FSB874	
Star Deluxe 150 (2T/Disc model)	150	2001 → 2003	FDB784			EF/AG	FSB874	
Star 150 (2T) All Models	150	2010 → 2014	FDB784			EF/AG	FSB874	
Star 150 (4T) All Models	150	2010 → 2014	FDB784			EF/AG	FSB874	
Star 151i (4T) All Models	151	2010 →	FDB784			EF/AG	FSB874	
Star 200i (4T) All Models	200	2010 →	FDB784			EF/AG		

* It is recommended that in those applications where sintered pads are supplied as Original Equipment, replacement pads should also be of sintered composition.

** To avoid brake imbalance sintered pads fitted in rear calipers should only be used in combination with front calipers containing sintered pads.



CC KW FROM -> TO



N° SET L/R COMPOUND



N° SET L/R COMPOUND

MACAL

50 FLASH	50	1999	→	FDB680			ST/EF			
TR 50 TROPHY	50	1999	→	FDB213			P			
TR 50 TROPHY H2O	50	1999	→	FRP405			ST/SG/PRP/P/EF			

MAICO

GM 250 CROSS	250	1984	→	FDB207			ST/P/EF/CP1			
250 CROSS	250	1986	→	FDB404			P	FDB404		P
250 CROSS	250	1998	→	FDB2018			ZR/ST/SG/P/EF	FDB2005		ST/SG/P/EF
GME 250 ENDURO	250	1984	→	FDB207			ST/P/EF/CP1			
250 ENDURO	250	1986	→	FDB404			P	FDB404		P
GP 250	250	1987	→	FDB404			P	FDB404		P
GSE 250 ALPHA-E	250		→ 1983	FSB847				FSB819		
LINK 250	250		→ 1983	FSB847				FSB819		
MX 250 TWIN	250		→ 1983	FSB847				FSB819		
400	400		→ 1983	FSB847				FSB819		
GP 400	400	1987	→	FDB404			P	FDB404		P
MX 490 LINK	490		→ 1983	FSB847				FSB819		
MX 490 TWIN	490		→ 1983	FSB847				FSB819		
GM 500 CROSS	500	1984	→	FDB207			ST/P/EF/CP1			
500 CROSS	500	1986	→	FDB404			P	FDB404		P
500 CROSS	500	1998	→	FDB2018			ZR/ST/SG/P/EF	FDB2005		ST/SG/P/EF
GME 500 ENDURO	500	1984	→	FDB207			ST/P/EF/CP1			
500 ENDURO	500	1986	→	FDB404			P	FDB404		P
GP 500	500	1987	→	FDB404			P	FDB404		P
GPE 500	500	1987	→	FDB404			P	FDB404		P

MALAGUTI

CHOPPER 25	25		→ 1982	FDB213			P	FSB902		
CHOPPER 40	40		→ 1982	FDB213			P	FSB902		
CENTRO 50	50		→ 1992	FSB907				FSB704		
CENTRO 50 SL	50	1993	→ 1999	FDB697			EF	FSB704		
CENTRO 50 4T / SL 4T	50	2008	→	FDB313			SG/P/EF	FSB704		
CIAK 50 / CIAK Master 4T 50	50	1999	→	FDB680			ST/EF	FSB704		
CR1 50 CROSSER	50	1995	→	FDB436			P	FSB941		
CR1 50 CROSSER	50	1996	→	FRP405			ST/SG/PRP/P/EF	FSB941		
DRAKON 50 NKD	50	2005	→	FDB2074			ST/SM/P/EF/CPRO/AG	FRP405		ST/SG/PRP/P/EF
DRIBBLING 50 (all models)	50	1987	→	FSB908				FSB908		
DUNE 50 ENDURO	50	1987	→	FDB436			P	FDB436		P
F 10 50 JETLINE	50	1992	→ 1993	FDB828			ST/P	FSB704		
F 10 50 JETLINE / F10 WAP JETLINE	50	1994	→	FDB680			ST/EF	FSB704		
F 12 50 PHANTOM (liquid cooled)	50	1994	→	FDB697			EF	FSB704		
F 12 50 PHANTOM (liquid cooled)	50	1995	→ 1997	FDB436			P	FSB704		
F 15 50 FIREFOX	50	1996	→ 1997	FDB436			P	FSB704		
F 12 50 PHANTOM Twin disk	50	1998	→	FDB680	2		ST/EF	FDB680		ST/EF
F 15 50 FIREFOX Twin disk	50	1998	→	FDB697	2		EF	FDB680		ST/EF
F 12 50 PHANTOM (liquid cooled)	50	1999	→	FDB697			EF	FDB680		ST/EF
F12 R 50 PHANTOM (all air cooled models)	50	2007	→ 2011	FDB680			ST/EF	FSB704		
F12 R 50 PHANTOM (all liquid cooled models)	50	2007	→ 2011	FDB680			ST/EF	FDB680		ST/EF
FIFTY 50 HF	50		→ 1982	FDB213			P	FSB907		
FIFTY 50 FULL (all models)	50	1983	→	FDB436			P	FSB907		
FIFTY 50 TOP	50	1985	→	FDB436			P	FSB907		
FIFTY 50 4 MARCE	50	1987	→	FSB907				FSB907		
FIFTY 50 HF	50	1987	→	FSB907				FSB907		
FIFTY 50 NL	50	1987	→	FSB907				FSB907		
FIFTY 50 RV	50	1987	→	FSB908				FSB908		
FIFTY 50 RV VARIATORE / KICK	50	1987	→	FSB908				FSB908		
FOX 50 CUSTOM	50	1988	→	FSB908				FSB908		
GRIZZLY 50 (all models)	50	1987	→	FSB908				FSB908		
GRIZZLY 50 RCX / "12"	50	1987	→	FDB213			P	FSB908		
LX 50 SPORT	50		→ 1982	FDB213			P	FSB902		
MDX GOLD 50 ENDURO	50	1987	→	FDB697			EF	FSB897		
MEX 50 ENDURO	50	1985	→	FDB2081			AG	FSB897		
MEX 50 ENDURO	50	1986	→	FDB731			P	FSB897		
MGX 50 ENDURO	50	1987	→	FSB897				FSB897		
MLX 50 ENDURO	50	1987	→	FDB697			EF	FSB897		
Mopeds 50 (all models)	50		→ 1983	FDB436			P	FSB902		
MR4 50 ENDURO	50	1987	→	FDB436			P	FDB436		P
RANOCCHIO 50 3 RUOTE	50	1988	→	FSB908				FSB908		
RCW 50 RONCO	50		→ 1982	FDB213			P	FSB902		
RCX-W 50 ENDURO	50	1983	→	FDB436			P			

* It is recommended that in those applications where sintered pads are supplied as Original Equipment, replacement pads should also be of sintered composition.

** To avoid brake imbalance sintered pads fitted in rear calipers should only be used in combination with front calipers containing sintered pads.



CC KW FROM -> TO N° SET L/R COMPOUND



N° SET L/R COMPOUND

...MALAGUTI

RGT 50 STRADA	50	1983	→	FDB436			P	FSB908		
RGT 50 SPORT	50	1985	→	FDB436			P	FSB897		
RST 50 SPORT tutti i tipi	50	1987	→	FDB436			P	FDB436		P
SAHIB 50 ENDURO	50	1983	→	FDB436			P			
VA 50 OLYMPIQUE	50		→ 1982	FDB213			P	FSB902		
WC 50 WATERCOOLED	50		→ 1982	FDB213			P	FSB907		
XSM 50 SUPERMOTARD	50	2003	→	FDB677			P/EF	FRP405		ST/SG/PRP/P/EF
XTM 50 / XSM 50	50	2003	→	FRP405			ST/SG/PRP/P/EF	FRP405		ST/SG/PRP/P/EF
YESTERDAY 50	50	1998	→	FDB680			ST/EF	FSB704		
CHOPPER 80	80		→ 1982	FDB213			P	FSB902		
MDX 80 ENDURO	80	1984	→	FDB2081			AG			
CIAK 100	100	1999	→ 2003	FDB680			ST/EF	FDB680		ST/EF
F 12 100 PHANTOM	100	1999	→ 2003	FDB680			ST/EF	FDB680		ST/EF
BLOG 125	125	2008	→	FDB2305			EF	FDB636		P/EF
CENTRO 125 ie/SL	125	2007	→ 2011	FDB2305			EF	FDB383		SG/P/EF
CIAK 125	125	2001	→	FDB2081			AG	FSB958		
F 18 WARRIOR 125	125	2001	→ 2003	FDB680			ST/EF	FDB680		ST/EF
MADISON 125	125	1999	→ 2003	FDB677			P/EF	FDB2090		P/EF
MADISON 3 - 125	125	2006	→	FDB677			P/EF	FDB2090		P/EF
PHANTOM MAX 125	125	2004	→	FDB677			P/EF	FDB2090		P/EF
X3M Enduro 125	125	2008	→	FRP405			ST/SG/PRP/P/EF	FRP405		ST/SG/PRP/P/EF
X3M Motard 125	125	2008	→	FDB677			P/EF	FRP405		ST/SG/PRP/P/EF
CIAK 150	150	2001	→	FDB2081			AG	FSB958		
F 18 WARRIOR 150	150	2001	→ 2003	FDB680			ST/EF	FDB680		ST/EF
MADISON 150	150	1999	→ 2003	FDB677			P/EF	FDB2090		P/EF
BLOG 160	160	2008	→	FDB2305			EF	FDB636		P/EF
CENTRO 160 ie	160	2008	→ 2011	FDB2305			EF			
CENTRO 160 ie	160	2008	→					FDB383		SG/P/EF
MADISON 180	180	1999	→ 2003	FDB677			P/EF	FDB2090		P/EF
MADISON S 200	200	2004	→	FDB677			P/EF	FDB2090		P/EF
PHANTOM MAX 200	200	2004	→	FDB677			P/EF	FDB2090		P/EF
MADISON 250	250	1999	→ 2003	FDB2105			EF/AG	FDB2090		P/EF
MADISON 3 250 RS	250	2004	→	FDB677			P/EF	FDB2090		P/EF
PASSWORD 250	250	2005	→	FDB677			P/EF	FDB2090		P/EF
PHANTOM MAX 250	250	2006	→	FDB677			P/EF	FDB2090		P/EF
MADISON K 400	400	2002	→	FDB2105			EF/AG	FDB2090		P/EF
SPIDER MAX RS 500/ GT	500	2004	→	FDB438	2		P/EF	FDB2074		ST/SM/P/EF/CP/PRO/AG

MALANCA

GT 5 50	50		→	FDB213			P			
ST 54	54		→	FDB213			P			
E2 C 80 CS	80		→	FDB207	2		ST/P/EF/CP1	FDB207		ST/P/EF/CP1
125	125		→	FDB213			P			
GTI 125	125		→	FDB207	2		ST/P/EF/CP1	FDB207		ST/P/EF/CP1
MARK 125 ENDURO	125		→	FDB207			ST/P/EF/CP1			
MARK 125	125	1985	→	FDB694			ST/AG	FSB898		
OB ONE 125 6M	125	1985	→	FDB694	2		ST/AG	FDB694		ST/AG
OB ONE 125 RACING	125	1985	→	FDB694	2		ST/AG	FDB694		ST/AG

MBK

ACTIVE 50	50		→ 1989	FSB739				FSB739		
ACTIVE 50	50	1990	→	FSB738				FSB739		
BOOSTER 50	50		→ 1994	FSB738				FSB738		
BOOSTER 50 R	50	1994	→ 1995	FDB889			ST/EF	FSB738		
BOOSTER 50 / SPIRIT	50	1996	→	FDB889			ST/EF	FSB738		
BOOSTER 50 NEXT GENERATION	50	1996	→ 1998	FDB889			ST/EF	FSB731		
BOOSTER 50 TRACK	50	1996	→ 1998	FDB889			ST/EF	FSB738		
CHAMP 50	50		→	FSB730				FSB730		
EVASION 50 (ruote in lega diritte)	50		→	FSB754				FSB754		
EVASION 50 (ruote in lega oblique)	50		→	FSB871				FSB871		
EVOLIS 50	50	1992	→	FDB889			ST/EF	FSB731		
FIZZ 50	50	1994	→	FDB889			ST/EF	FSB738		
FLIPPER 50	50	1998	→	FDB680			ST/EF	FSB738		
FORTE 50	50	1995	→	FDB889			ST/EF	FSB738		
HARDROCK 50 (ruote in lega diritte)	50		→	FSB754				FSB754		
HARDROCK 50 (ruote in lega oblique)	50		→	FSB871				FSB871		
MAGNUM 50 (ruote in lega diritte)	50		→	FSB754				FSB754		
MAGNUM 50 (ruote in lega oblique)	50		→	FSB871				FSB871		
NITRO 50	50	1997	→	FDB889			ST/EF	FDB2062		EF
OVETTO 50	50	1997	→	FDB889			ST/EF	FSB731		

* It is recommended that in those applications where sintered pads are supplied as Original Equipment, replacement pads should also be of sintered composition.

** To avoid brake imbalance sintered pads fitted in rear calipers should only be used in combination with front calipers containing sintered pads.



CC KW FROM -> TO N° SET L/R COMPOUND N° SET L/R COMPOUND

...MBK

PASSION 50 (ruote in lega diritte)	50		→	FSB754				FSB754			
PASSION 50 (ruote in lega oblique)	50		→	FSB871				FSB871			
ROCKET 50	50	1996	→ 1998	FDB889			ST/EF	FSB731			
SORRISO 50	50	1992	→ 1996	FSB731				FSB731			
STUNT 50	50	2000	→	FDB680			ST/EF	FSB731			
TARGET 50	50	1992	→	FDB636			P/EF	FSB731			
X-LIMIT 50	50	1998	→ 2003	FDB697			EF	FSB731			
ACTIVE 75	75	1990	→	FSB738				FSB739			
ACTIVE 80	80		→ 1989	FSB739				FSB739			
ACTIVE 80	80	1990	→	FSB738				FSB739			
EVOLIS 80	80	1994	→	FDB889			ST/EF	FSB731			
BOOSTER 100	100	2000	→ 2002	FDB636			P/EF	FSB947			
NITRO 100	100	2000	→ 2003	FDB680			ST/EF	FSB733			
OVETTO 100	100	2000	→ 2002	FDB680			ST/EF	FSB733			
DOODO 125	125	2001	→ 2003	FDB2018			ZR/ST/SG/P/EF	FSB947			
SKYLINER 01 - 125	125	1998	→ 2000	FDB2018			ZR/ST/SG/P/EF	FSB947			
SKYLINER 125 / S.E.	125	2001	→	FDB2018			ZR/ST/SG/P/EF	FDB2074			ST/SM/P/EF/CPRO/AG
THUNDER 125	125	2001	→	FDB2018			ZR/ST/SG/P/EF	FDB2074			ST/SM/P/EF/CPRO/AG
XC 125 FLAME	125	1998	→	FDB383			SG/P/EF	FSB731			
XC 125 FLAME R	125	1998	→	FDB383			SG/P/EF	FSB731			
YW 125 Z X-Over	125	2010	→ 2010	FDB2264			EF	FSB967			
DOODO 150	150	2001	→ 2003	FDB2018			ZR/ST/SG/P/EF	FSB947			
SKYLINER 150	150	2000	→ 2002	FDB2018			ZR/ST/SG/P/EF	FSB947			
THUNDER 150	150	2001	→ 2002	FDB2018			ZR/ST/SG/P/EF	FDB2074			ST/SM/P/EF/CPRO/AG
SKYLINER 180	180	2004	→	FDB2018			ZR/ST/SG/P/EF	FDB2074			ST/SM/P/EF/CPRO/AG
SKYLINER 250	250	2000	→ 2002	FDB2003			ST/SM/P/EF	FDB2083			ST/SM/P/EF
KILIBRE 300	300	2003	→	FDB2018			ZR/ST/SG/P/EF	FDB2018			ZR/ST/SG/P/EF
SKYLINER 400	400	2004	→	FDB2003			ST/SM/P/EF	FDB2200			SM/P/EF

MODENAS

KRISS 115	115		→ 1998	FSB722				FSB722			
KRISS 115	115	1999	→	FDB631			ST/SM/SG/P/EF/AG	FSB722			

MONTESA

MKS 50	50	1987	→	FDB436			P	FSB820			
COTA 123	123		→ 1983	FSB820				FSB820			
COTA 123	123	1983	→					FSB820			
COTA 242	242	1983	→					FSB820			
RC 248	248		→	FSB857				FSB857			
EVASION 260	260	1994	→	FRP405			ST/SG/PRP/P/EF	FRP405			ST/SG/PRP/P/EF
COTA 290	290		→ 1983	FSB820				FSB820			
COTA 304	304	1987	→	FDB436			P	FSB820			
COTA 309	309	1989	→	FDB2107			P	FDB207			ST/P/EF/CP1
COTA 310	310	1990	→	FRP405			ST/SG/PRP/P/EF	FRP405			ST/SG/PRP/P/EF
COTA 314 R	314	1994	→	FRP405			ST/SG/PRP/P/EF	FDB207			ST/P/EF/CP1
COTA 315 R	315	1998	→	FRP405			ST/SG/PRP/P/EF	FDB889			ST/EF
TRIAL 330	330	1985	→					FSB820			
COTA 335	335	1987	→	FRP405			ST/SG/PRP/P/EF	FRP405			ST/SG/PRP/P/EF
COTA 335	335	1989	→	FDB2107			P	FDB2107			P
T 348	348		→ 1983	FSB820				FSB820			
COTA 349	349		→ 1983	FSB820				FSB820			
COTA 349	349	1983	→					FSB820			
H7-S 360	360		→	FDB2107			P				
old models	1500		→	FSB851							

MONTESA (HONDA)

MH 123	123	1983	→					FSB820			
MH 200	200	1983	→					FSB820			
COTA 250 4RT	250	2005	→ 2010	FDB2109			P	FDB2127			SG
4 RIDE 260	260	2016	→					FDB2127			SG
COTA 260 4RT	260	2014	→	FDB2109			P	FDB2127			SG
MH 311 260	260	1992	→ 1993	FRP405			ST/SG/PRP/P/EF	FDB207			ST/P/EF/CP1
COTA 310	310	1989	→	FDB2107			P	FDB207			ST/P/EF/CP1
COTA 310 4T / 4RT	310	2007	→	FDB2109			P	FDB207			ST/P/EF/CP1
MH 314 R	314	1994	→ 1997	FRP405			ST/SG/PRP/P/EF	FDB207			ST/P/EF/CP1
MH 315 R	315	1997	→ 2000	FRP405			ST/SG/PRP/P/EF	FDB207			ST/P/EF/CP1
MH 315 R	315	2001	→ 2004	FDB2109			P	FDB2127			SG
MH 349	349	1983	→					FSB820			

* It is recommended that in those applications where sintered pads are supplied as Original Equipment, replacement pads should also be of sintered composition.

** To avoid brake imbalance sintered pads fitted in rear calipers should only be used in combination with front calipers containing sintered pads.



MOTO GUZZI

	CC	KW	FROM -> TO		N° SET	L/R	COMPOUND		N° SET	L/R	COMPOUND
CHIU' 50	50		1974 → 1976	FSB902					FSB902		
CROSS 50	50		1975 → 1976	FSB847					FSB847		
CROSS 50	50		1976 → 1982	FSB847					FSB847		
DINGO 50 3M	50		1966 → 1974	FSB902					FSB902		
DINGO 50 CROSS	50		1966 → 1974	FSB907					FSB907		
DINGO 50 GT	50		1966 → 1974	FSB907					FSB907		
DINGO 50 SPORT	50		1966 → 1974	FSB907					FSB907		
DINGO 50 SUPER	50		1966 → 1974	FSB907					FSB907		
DINGO 50 TURISMO	50		1966 → 1974	FSB907					FSB907		
DINGO 50 M	50		1969 → 1973	FSB902					FSB902		
DINGO 50 3 V	50		1975 → 1976	FSB902					FSB902		
DINGO 50 MM	50		1975 → 1976	FSB902					FSB902		
MAGNUM 50	50		1975 → 1976	FSB902					FSB902		
NIBBIO 50	50		1975 → 1976	FSB847					FSB847		
TROTTER 50	50		1966 → 1970	FSB902					FSB902		
TROTTER 50 SUPER	50		1966 → 1970	FSB902					FSB902		
TROTTER 50 MARK M - V	50		1971 → 1973	FSB902					FSB902		
TROTTER 50 SPECIAL M - V	50		1971 → 1973	FSB902					FSB902		
2C 125 4T	125		1979 →	FDB207			ST/P/EF/CP1		FSB818		
TT 125	125		1985 →	FDB207			ST/P/EF/CP1		FSB911		
TURISMO 125	125		1974 → 1981	FDB213			P		FSB897		
TUTTOTERRENO 125	125		1974 → 1981	FSB897					FSB897		
STORNELLO 160 (5 speed)	160		1971 → 1974	FSB818							
TS 250	250		1974 → 1975	FDB207			ST/P/EF/CP1		FSB818		
TS 250	250		1976 → 1982	FDB207			ST/P/EF/CP1		FDB207		ST/P/EF/CP1
254	254		1977 → 1981						FSB818		
GTS 350	350		1974 → 1979	FDB207			ST/P/EF/CP1		FDB207		ST/P/EF/CP1
GTS 350	350		1974 → 1975						FSB818		
NEVADA 350	350		1993 →	FDB207	2		ST/P/EF/CP1		FDB207		ST/P/EF/CP1
NTX 350	350		1987 →	FDB207			ST/P/EF/CP1		FDB207		ST/P/EF/CP1
NTX 350	350		1990 →	FDB207			ST/P/EF/CP1		FDB108		ST/P/EF/CPRO
V 35 350 IMOLA	350		1970 → 1983	FDB207	2		ST/P/EF/CP1		FDB207		ST/P/EF/CP1
V 35 350	350		1977 →	FDB207	2		ST/P/EF/CP1		FDB207		ST/P/EF/CP1
V 35 350 C	350		1982 →	FDB207	2		ST/P/EF/CP1		FDB207		ST/P/EF/CP1
V 35 350 IMOLA II	350		1984 →	FDB207	2		ST/P/EF/CP1		FDB207		ST/P/EF/CP1
V 35 350 TT ENDURO	350		1984 →	FDB207			ST/P/EF/CP1		FDB207		ST/P/EF/CP1
V 35 350 FLORIDA	350		1987 →	FDB207	2		ST/P/EF/CP1		FDB207		ST/P/EF/CP1
V 35 350 GT	350		1990 →	FDB108			ST/P/EF/CPRO		FDB207		ST/P/EF/CP1
GTS 400	400		1974 → 1979	FDB207			ST/P/EF/CP1		FDB207		ST/P/EF/CP1
V 50 500	500		1977 → 1980	FDB207			ST/P/EF/CP1		FDB207		ST/P/EF/CP1
V 50 500 III	500		1980 →	FDB207			ST/P/EF/CP1		FDB207		ST/P/EF/CP1
V 50 500 MONZA	500		1980 → 1983	FDB207			ST/P/EF/CP1		FDB207		ST/P/EF/CP1
V 50 500 C	500		1982 →	FDB207			ST/P/EF/CP1		FDB207		ST/P/EF/CP1
V 50 500 MONZA II	500		1984 →	FDB207	2		ST/P/EF/CP1		FDB207		ST/P/EF/CP1
NTX 650	650		1990 →	FDB207			ST/P/EF/CP1		FDB108		ST/P/EF/CPRO
V 65 650	650		1981 → 1983	FDB207	2		ST/P/EF/CP1		FDB207		ST/P/EF/CP1
V 65 650 SP CHOPPER	650		1981 →	FDB207	2		ST/P/EF/CP1		FDB207		ST/P/EF/CP1
V 65 650 II ENDURO	650		1984 →	FDB207			ST/P/EF/CP1		FDB207		ST/P/EF/CP1
V 65 650 LARIO	650		1984 →	FDB207	2		ST/P/EF/CP1		FDB207		ST/P/EF/CP1
VT 650 TT BAJA	650		1986 →	FDB592			P		FDB207		ST/P/EF/CP1
V 65 650 FLORIDA	650		1987 →	FDB207	2		ST/P/EF/CP1		FDB207		ST/P/EF/CP1
V 65 650 GT	650		1990 →	FDB108			ST/P/EF/CPRO		FDB207		ST/P/EF/CP1
V 7 700	700		1967 → 1976	FSB880					FSB881		
V 7 700 SPECIAL	700		1969 → 1971	FSB796					FSB881		
BREVA 750 IE	750		2003 → 2011	FDB2042			ZRAC/XRAC/ST/P/EF/CPRO		FDB2074		ST/SM/P/EF/CPRO/AG
NTX 750	750		1990 →	FDB583			P		FDB108		ST/P/EF/CPRO
S 750	750		1974 → 1975	FDB108	2		ST/P/EF/CPRO				
S3 750	750		1975 → 1976	FDB108			ST/P/EF/CPRO		FDB108		ST/P/EF/CPRO
SP 750 NEVADA	750		1992 →	FDB207			ST/P/EF/CP1		FDB207		ST/P/EF/CP1
SP 750 NEVADA CLUB	750		2000 → 2002	FDB207			ST/P/EF/CP1		FDB207		ST/P/EF/CP1
SP 750 NEVADA CLUB / CLASSIC I.E. / Aquila Nera	750		2002 →	FDB2042			ZRAC/XRAC/ST/P/EF/CPRO		FDB2074		ST/SM/P/EF/CPRO/AG
T 750	750		1992 → 1994	FDB207			ST/P/EF/CP1		FDB207		ST/P/EF/CP1
V 750 750 SPORT	750		1972 → 1974	FSB796							
V7 Classic	750		2008 → 2012	FDB2042			ZRAC/XRAC/ST/P/EF/CPRO		FDB2074		ST/SM/P/EF/CPRO/AG
V7 Cafe Classic	750		2009 → 2012	FDB2042			ZRAC/XRAC/ST/P/EF/CPRO		FDB2074		ST/SM/P/EF/CPRO/AG
V7 Racer	750		2010 → 2011	FDB2042			ZRAC/XRAC/ST/P/EF/CPRO		FDB2074		ST/SM/P/EF/CPRO/AG
V7 II Racer	750		2012 →	FDB2042			ZRAC/XRAC/ST/P/EF/CPRO		FDB2060		P/AG
V7 II Special	750		2012 →	FDB2042			ZRAC/XRAC/ST/P/EF/CPRO		FDB2060		P/AG
V7 II Stone	750	25	2012 → 2014	FDB2042			ZRAC/XRAC/ST/P/EF/CPRO		FDB2060		P/AG
V7 II Stone	750	37	2012 →	FDB2042			ZRAC/XRAC/ST/P/EF/CPRO		FDB2060		P/AG
V7 II Stornello	750		2016 →	FDB2042			ZRAC/XRAC/ST/P/EF/CPRO		FDB2060		P/AG
V7 III Anniversario	750		2017 →	FDB2042			ZRAC/XRAC/ST/P/EF/CPRO		FDB2060		P/AG
V7 III Racer	750		2017 →	FDB2042			ZRAC/XRAC/ST/P/EF/CPRO		FDB2060		P/AG
V7 III Special	750		2017 →	FDB2042			ZRAC/XRAC/ST/P/EF/CPRO		FDB2060		P/AG

* It is recommended that in those applications where sintered pads are supplied as Original Equipment, replacement pads should also be of sintered composition.

** To avoid brake imbalance sintered pads fitted in rear calipers should only be used in combination with front calipers containing sintered pads.



CC KW FROM -> TO N° SET L/R COMPOUND N° SET L/R COMPOUND

...MOTO GUZZI

V7 III Stone	750	2017	→	FDB2042			ZRAC/XRAC/ST/P/EF/CPRO	FDB2060			P/AG
BREVA V 850	850	2007	→	FDB2042	2		ZRAC/XRAC/ST/P/EF/CPRO	FDB2018			ZR/ST/SG/P/EF
CALIFORNIA 850 GT	850	1972	→ 1974	FSB796							
CALIFORNIA 850 T3	850	1975	→ 1980	FDB108	2		ST/P/EF/CPRO	FDB108			ST/P/EF/CPRO
GRISO 850	850	2007	→	FDB2042	2		ZRAC/XRAC/ST/P/EF/CPRO	FDB2018			ZR/ST/SG/P/EF
GT 850	850	1972	→ 1974	FSB796							
LE MANS 850	850	1976	→	FDB148	2		ST/P	FDB148			ST/P
T 850	850	1974	→ 1975	FDB148			ST/P	FSB796			
T3 850	850	1975	→ 1979	FDB148	2		ST/P	FDB148			ST/P
T4 850	850	1980	→ 1983	FDB148	2		ST/P	FDB148			ST/P
T5 850	850	1984	→	FDB108	2		ST/P/EF/CPRO	FDB108			ST/P/EF/CPRO
V9 Bobber	850	2016	→	FDB2042			ZRAC/XRAC/ST/P/EF/CPRO	FDB2060			P/AG
V9 Roamer	850	2016	→	FDB2042			ZRAC/XRAC/ST/P/EF/CPRO	FDB2060			P/AG
V85 TT	853	59	2020	→	FDB2042	2	ZRAC/XRAC/ST/P/EF/CPRO	FDB2060			P/AG
V9	900	2017	→	FDB2042			ZRAC/XRAC/ST/P/EF/CPRO	FDB2060			P/AG
V9 X-Track	900	2017	→	FDB2042			ZRAC/XRAC/ST/P/EF/CPRO	FDB2060			P/AG
940 - Bellagio	940	2007	→ 2012	FDB2006	2		ST/P/EF	FDB2018			ZR/ST/SG/P/EF
BELLAGIO 1000 / Aquila Nera	1000	2008	→	FDB2006	2		ST/P/EF	FDB570			XRAC/ST/SM/P/EF/CPRO
CALIFORNIA 1000 II	1000	1981	→ 1987	FDB108	2		ST/P/EF/CPRO	FDB108			ST/P/EF/CPRO
CALIFORNIA 1000 III	1000	1988	→ 1993	FDB108	2		ST/P/EF/CPRO	FDB108			ST/P/EF/CPRO
CENTAURO 1000	1000	1996	→ 1999	FRP408	2		XRAC/ST/PR/P/CPRO/CP1	FDB2006			ST/P/EF
DAYTONA 1000	1000	1991	→ 1994	FRP408	2		XRAC/ST/PR/P/CPRO/CP1	FDB108			ST/P/EF/CPRO
DAYTONA 1000	1000	1995	→ 1998	FRP408	2		XRAC/ST/PR/P/CPRO/CP1	FDB108			ST/P/EF/CPRO
GT V 1000	1000	1991	→	FDB108	2		ST/P/EF/CPRO	FDB108			ST/P/EF/CPRO
LE MANS 1000	1000	1984	→ 1993	FDB108	2		ST/P/EF/CPRO	FDB108			ST/P/EF/CPRO
LE MANS - V 1000	1000	1990	→	FDB108	2		ST/P/EF/CPRO	FDB108			ST/P/EF/CPRO
QUOTA 1000	1000	1993	→ 1995	FDB498	2		XRAC/ST/P	FDB207			ST/P/EF/CP1
SP 1000	1000	1978	→ 1983	FDB108	2		ST/P/EF/CPRO	FDB204			P
SP 1000 II	1000	1984	→	FDB108	2		ST/P/EF/CPRO	FDB108			ST/P/EF/CPRO
SP III 1000	1000	1991	→	FDB108	2		ST/P/EF/CPRO	FDB108			ST/P/EF/CPRO
V 1000 1000 I CONVERT	1000	1975	→	FDB148	2		ST/P	FDB148			ST/P
V 1000 1000 G5	1000	1978	→	FDB148	2		ST/P	FDB148			ST/P
LE MANS V 11	1064	2001	→	FDB2042	2		ZRAC/XRAC/ST/P/EF/CPRO	FDB207			ST/P/EF/CP1
BREVA V 1100	1100	2004	→	FDB2042	2		ZRAC/XRAC/ST/P/EF/CPRO	FDB2074			ST/SM/P/EF/CPRO/AG
BREVA V 1100 (Std/ABS Models)	1100	2005	→ 2007	FDB2042	2		ZRAC/XRAC/ST/P/EF/CPRO	FDB2018			ZR/ST/SG/P/EF
CALIFORNIA 1100	1100	1994	→ 1997	FDB108	2		ST/P/EF/CPRO	FDB108			ST/P/EF/CPRO
CALIFORNIA 1100	1100	1997	→ 2001	FRP408	2		XRAC/ST/PR/P/CPRO/CP1	FDB2006			ST/P/EF
CALIFORNIA 1100 EV	1100	1997	→ 2000	FRP408	2		XRAC/ST/PR/P/CPRO/CP1	FDB2006			ST/P/EF
CALIFORNIA (all models)	1100	2001	→ 2006	FDB2042	2		ZRAC/XRAC/ST/P/EF/CPRO	FDB2006			ST/P/EF
California 1100 Classic Touring	1100	2006	→ 2008	FDB2042	2		ZRAC/XRAC/ST/P/EF/CPRO	FDB2006			ST/P/EF
California 1100 Vintage	1100	2006	→ 2012	FDB2042	2		ZRAC/XRAC/ST/P/EF/CPRO	FDB2006			ST/P/EF
California 1100 Aquila Nera	1100	2009	→ 2011	FDB2042	2		ZRAC/XRAC/ST/P/EF/CPRO	FDB2006			ST/P/EF
California 1100 90	1100	2012	→ 2012	FDB2042	2		ZRAC/XRAC/ST/P/EF/CPRO	FDB2006			ST/P/EF
CENTAURO 1100 V11 SPORT	1100	1999	→ 2000	FRP408	2		XRAC/ST/PR/P/CPRO/CP1	FDB2006			ST/P/EF
GRISO 1100	1100	2005	→ 2008	FDB2042	2		ZRAC/XRAC/ST/P/EF/CPRO	FDB2018			ZR/ST/SG/P/EF
QUOTA 1100 ES	1100	1999	→ 2001	FDB2006	2		ST/P/EF	FDB2018			ZR/ST/SG/P/EF
SPORT 1100	1100	1994	→ 1999	FRP408			XRAC/ST/PR/P/CPRO/CP1	FDB207			ST/P/EF/CP1
BREVA 1200	1200	2008	→ 2009	FDB2042	2		ZRAC/XRAC/ST/P/EF/CPRO	FDB2018			ZR/ST/SG/P/EF
BREVA 1200 SPORT	1200	2008	→ 2013	FDB2042	2		ZRAC/XRAC/ST/P/EF/CPRO	FDB2018			ZR/ST/SG/P/EF
CORSARO Avio / Veloce	1200	2010	→	FDB2042	2		ZRAC/XRAC/ST/P/EF/CPRO	FDB2074			ST/SM/P/EF/CPRO/AG
GRANFERRO 1200	1200	2010	→	FDB2260	2		XRAC/ST/CPRO	FDB2018			ZR/ST/SG/P/EF
GRAN PASSO 1200 / H83	1200	2010	→	FDB2006	2		ST/P/EF	FDB2018			ZR/ST/SG/P/EF
GRISO SE 1200 8V	1200	2007	→ 2013	FDB2042	2		ZRAC/XRAC/ST/P/EF/CPRO	FDB2018			ZR/ST/SG/P/EF
1200 GT	1200	2010	→	FDB2042	2		ZRAC/XRAC/ST/P/EF/CPRO	FDB2074			ST/SM/P/EF/CPRO/AG
NORGE 1200	1200	2006	→ 2008	FDB2042	2		ZRAC/XRAC/ST/P/EF/CPRO	FDB2018			ZR/ST/SG/P/EF
NORGE 1200 GT 8V ABS	1200	2010	→	FDB2042	2		ZRAC/XRAC/ST/P/EF/CPRO	FDB2018			ZR/ST/SG/P/EF
SCRAMBLER 1200	1200	2010	→	FDB2006	2		ST/P/EF	FDB2018			ZR/ST/SG/P/EF
STELVIO 1200	1200	2008	→ 2011	FDB2042	2		ZRAC/XRAC/ST/P/EF/CPRO	FDB2018			ZR/ST/SG/P/EF
STELVIO 1200 NTX ABS	1200	2009	→ 2010	FDB2042	2		ZRAC/XRAC/ST/P/EF/CPRO	FDB2018			ZR/ST/SG/P/EF
STELVIO 1200 8V ABS	1200	2011	→	FDB2042	2		ZRAC/XRAC/ST/P/EF/CPRO	FDB2018			ZR/ST/SG/P/EF
STELVIO 1200 8V NTX	1200	2011	→	FDB2042	2		ZRAC/XRAC/ST/P/EF/CPRO	FDB2018			ZR/ST/SG/P/EF
V12 LM	1200	2010	→	FDB2123	2		XRAC/CPRO	FDB2018			ZR/ST/SG/P/EF
V12 X / Strada	1200	2010	→	FDB2260	2		XRAC/ST/CPRO	FDB570			XRAC/ST/SM/P/EF/CPRO
MGS - 01 Corsa	1225	2007	→	FDB2120	2		ZRAC/XRAC/ST	FDB2074			ST/SM/P/EF/CPRO/AG
Audace	1380	2016	→	FDB2042	2		ZRAC/XRAC/ST/P/EF/CPRO	FDB2006			ST/P/EF
Audace Carbon	1380	2017	→	FDB2042	2		ZRAC/XRAC/ST/P/EF/CPRO	FDB2006			ST/P/EF
California Touring SE	1380	2016	→	FDB2042	2		ZRAC/XRAC/ST/P/EF/CPRO	FDB2006			ST/P/EF
Eldorado	1380	2016	→	FDB2042	2		ZRAC/XRAC/ST/P/EF/CPRO	FDB2006			ST/P/EF
California 1400 Custom	1400	2013	→	FDB2042	2		ZRAC/XRAC/ST/P/EF/CPRO	FDB2006			ST/P/EF
California 1400 Touring	1400	2013	→	FDB2042	2		ZRAC/XRAC/ST/P/EF/CPRO	FDB2006			ST/P/EF
MGX-21 Flying fortress	1400	2016	→	FDB2042	2		ZRAC/XRAC/ST/P/EF/CPRO	FDB2006			ST/P/EF

* It is recommended that in those applications where sintered pads are supplied as Original Equipment, replacement pads should also be of sintered composition.

** To avoid brake imbalance sintered pads fitted in rear calipers should only be used in combination with front calipers containing sintered pads.

1070



MOTO MORINI

	CC	KW	FROM -> TO		N° SET	L/R	COMPOUND		N° SET	L/R	COMPOUND
CAMEL 501	50		→ 1986	FDB207			ST/P/EF/CP1				
CAMEL 501	50	1987	→	FDB438			P/EF	FDB207			ST/P/EF/CP1
COGUARO 501	50	1989	→	FDB529			P	FDB207			ST/P/EF/CP1
EXCALIBUR 501	50	1986	→ 1986	FDB438			P/EF				
EXCALIBUR 501	50	1987	→ 1988	FDB438			P/EF	FDB207			ST/P/EF/CP1
EXCALIBUR 501	50	1989	→	FDB499			P	FDB207			ST/P/EF/CP1
NEW YORK 501	50	1989	→	FDB499			P	FDB207			ST/P/EF/CP1
BLUES 125	125	1993	→	FDB438			P/EF	FDB207			ST/P/EF/CP1
KJ 125	125	1984	→					FSB847			
MONOCILINDRO 125	125	1979	→	FDB205			P	FSB847			
BICILINDRO 250	250	1979	→	FDB205			P	FSB876			
MONOCILINDRO 250	250		→ 1981	FDB205			P	FSB876			
SPORT 250	250		→ 1970	FDB205			P	FSB847			
TURISMO 250	250		→ 1970	FDB205			P	FSB847			
COGAURO 350	350	1990	→	FDB499			P	FDB207			ST/P/EF/CP1
DART 350	350	1988	→ 1989	FDB499			P	FDB207			ST/P/EF/CP1
DART 350	350	1990	→	FDB529			P	FDB207			ST/P/EF/CP1
EXCALIBUR 350	350	1986	→ 1989	FDB438			P/EF				
EXCALIBUR RLX 350	350	1990	→	FDB499			P	FDB207			ST/P/EF/CP1
GT 350	350	1976	→ 1981	FDB205			P	FSB853			
GT 350	350	1979	→	FDB205			P	FSB876			
GT 350 TURISMO	350	1980	→	FDB205			P	FSB876			
K2 350	350	1984	→	FDB696			AG				
KANGURO 350	350		→ 1983	FSB901				FSB852			
KANGURO 350	350	1984	→					FSB852			
KANGURO 350	350	1987	→	FDB438			P/EF	FDB207			ST/P/EF/CP1
NEW YORK 350	350	1989	→	FDB499			P	FDB207			ST/P/EF/CP1
SPORT 350	350		→ 1980	FDB205			P	FDB205			P
SPORT 350	350	1980	→	FDB205			P	FSB876			
SPORT 350	350	1981	→	FDB205			P	FSB853			
WS 350 PRO ACTION	350	1993	→	FDB592			P	FDB207			ST/P/EF/CP1
XE 350	350	1985	→					FSB852			
DART 400	400	1990	→	FDB529			P	FDB207			ST/P/EF/CP1
CAMEL 500	500		→ 1983	FSB901				FSB852			
CAMEL 500	500	1984	→					FSB901			
T.T. 500	500	1980	→	FDB205			P				
9,5	1200	2006	→	FDB2042	2		ZRAC/XRAC/ST/P/EF/CPRO	FDB2074			ST/SM/P/EF/CPRO/AG
Corsaro Veloce / Corsaro 1200 / Corsaro Avio	1200	2005	→	FDB2042	2		ZRAC/XRAC/ST/P/EF/CPRO	FDB2074			ST/SM/P/EF/CPRO/AG
Granpasso 1200 / H83	1200	2008	→	FDB2006	2		ST/P/EF	FDB2018			ZR/ST/SG/P/EF
MM3	1200	2007	→	FDB2042	2		ZRAC/XRAC/ST/P/EF/CPRO	FDB2074			ST/SM/P/EF/CPRO/AG
Scrambler 1200	1200	2008	→	FDB2006	2		ST/P/EF	FDB2018			ZR/ST/SG/P/EF
1200 SPORT	1200	2008	→	FDB2042	2		ZRAC/XRAC/ST/P/EF/CPRO	FDB2074			ST/SM/P/EF/CPRO/AG

MOTOBECANE

all models 50 (mozzi atom)	50	1988	→ 1989	FSB712							
all models 50 (mozzi leleu)	50	1988	→ 1989	FSB712							

MOTORHISPANIA

MX 50 FURIA	50	2000	→	FRP405			ST/SG/PRP/P/EF	FRP405			ST/SG/PRP/P/EF
RX 50 RACING	50	2000	→	FDB438			P/EF	FRP405			ST/SG/PRP/P/EF

MOTRON

KCV 50	50		→	FDB250			SG/P/EF				
V 3 50 RID	50		→	FDB213			P				

MV AGUSTA

BRUTALE 675 (B3)	675	2012	→	FDB2042	2		ZRAC/XRAC/ST/P/EF/CPRO	FDB2074			ST/SM/P/EF/CPRO/AG
F3 675	675	2012	→ 2014	FDB2042	2		ZRAC/XRAC/ST/P/EF/CPRO	FDB2074			ST/SM/P/EF/CPRO/AG
F3 675 Oro	675	2012	→	FDB2260	2		XRAC/ST/CPRO	FDB2074			ST/SM/P/EF/CPRO/AG
F3 675	675	2015	→	FDB2260	2		XRAC/ST/CPRO	FDB2074			ST/SM/P/EF/CPRO/AG
F3 675 CIV	675	2015	→	FDB2042	2		ZRAC/XRAC/ST/P/EF/CPRO	FDB2074			ST/SM/P/EF/CPRO/AG
F3 675 WSS	675	2015	→	FDB2260	2		XRAC/ST/CPRO	FDB2074			ST/SM/P/EF/CPRO/AG
F3 675 RC	675	2016	→	FDB2260	2		XRAC/ST/CPRO	FDB2074			ST/SM/P/EF/CPRO/AG
F3 675 RC Lim.ed.	675	94	2018	→	FDB2260	2	XRAC/ST/CPRO	FDB2074			ST/SM/P/EF/CPRO/AG
BRUTALE 750 F4	750	2003	→ 2005	FDB2036	2		XRAC/ST/P	FDB2198			ST
Brutale 800 RR America	798	103	2018	→	FDB2042	2	ZRAC/XRAC/ST/P/EF/CPRO	FDB2074			ST/SM/P/EF/CPRO/AG
Brutale 800 RR Pirelli	798	103	2018	→	FDB2042	2	ZRAC/XRAC/ST/P/EF/CPRO	FDB2074			ST/SM/P/EF/CPRO/AG

* It is recommended that in those applications where sintered pads are supplied as Original Equipment, replacement pads should also be of sintered composition.
 ** To avoid brake imbalance sintered pads fitted in rear calipers should only be used in combination with front calipers containing sintered pads.



CC KW FROM -> TO N° SET L/R COMPOUND N° SET L/R COMPOUND

...MV AGUSTA

Dragster Rosso	798		2020	→	FDB2042	2		ZRAC/XRAC/ST/PI/EF/CPRO	FDB2074		ST/SM/PI/EF/CPRO/AG
RVS#1 Lim.ed.	798	103	2018	→	FDB2042	2		ZRAC/XRAC/ST/PI/EF/CPRO	FDB2074		ST/SM/PI/EF/CPRO/AG
Superveloce 800	798		2020	→	FDB2260	2		XRAC/ST/CPRO	FDB2074		ST/SM/PI/EF/CPRO/AG
Superveloce Serie Oro 800	798		2020	→	FDB2260	2		XRAC/ST/CPRO	FDB2074		ST/SM/PI/EF/CPRO/AG
BRUTALE 800 (B31)	800		2012	→	FDB2042	2		ZRAC/XRAC/ST/PI/EF/CPRO	FDB2074		ST/SM/PI/EF/CPRO/AG
BRUTALE 800 (B3)	800		2015	→	FDB2042	2		ZRAC/XRAC/ST/PI/EF/CPRO	FDB2074		ST/SM/PI/EF/CPRO/AG
BRUTALE 800 RR (B3)	800		2015	→	FDB2042	2		ZRAC/XRAC/ST/PI/EF/CPRO	FDB2074		ST/SM/PI/EF/CPRO/AG
BRUTALE DRAGSTER 800	800		2015	→	FDB2042	2		ZRAC/XRAC/ST/PI/EF/CPRO	FDB2074		ST/SM/PI/EF/CPRO/AG
BRUTALE DRAGSTER 800 RR	800		2015	→	FDB2042	2		ZRAC/XRAC/ST/PI/EF/CPRO	FDB2074		ST/SM/PI/EF/CPRO/AG
BRUTALE DRAGSTER 800 RR LH44	800		2015	→	FDB2042	2		ZRAC/XRAC/ST/PI/EF/CPRO	FDB2074		ST/SM/PI/EF/CPRO/AG
BRUTALE 800 (B11)	800		2016	→	FDB2042	2		ZRAC/XRAC/ST/PI/EF/CPRO	FDB2074		ST/SM/PI/EF/CPRO/AG
BRUTALE DRAGSTER 800 RC	800	103	2017	→	FDB2042	2		ZRAC/XRAC/ST/PI/EF/CPRO	FDB2074		ST/SM/PI/EF/CPRO/AG
BRUTALE 800 RC	800	81	2019	→	FDB2042	2		ZRAC/XRAC/ST/PI/EF/CPRO	FDB2074		ST/SM/PI/EF/CPRO/AG
DRAGSTER 800 RC	800	103	2019	→	FDB2042	2		ZRAC/XRAC/ST/PI/EF/CPRO	FDB2074		ST/SM/PI/EF/CPRO/AG
DRAGSTER 800 RR	800	103	2019	→	FDB2042	2		ZRAC/XRAC/ST/PI/EF/CPRO	FDB2074		ST/SM/PI/EF/CPRO/AG
DRAGSTER 800 RR America	800	103	2019	→	FDB2042	2		ZRAC/XRAC/ST/PI/EF/CPRO	FDB2074		ST/SM/PI/EF/CPRO/AG
DRAGSTER 800 RR LH44	800	103	2019	→	FDB2042	2		ZRAC/XRAC/ST/PI/EF/CPRO	FDB2074		ST/SM/PI/EF/CPRO/AG
DRAGSTER 800 RR Pirelli	800	103	2019	→	FDB2042	2		ZRAC/XRAC/ST/PI/EF/CPRO	FDB2074		ST/SM/PI/EF/CPRO/AG
F3 800	800		2014	→	FDB2260	2		XRAC/ST/CPRO	FDB2074		ST/SM/PI/EF/CPRO/AG
F3 800 RC	800		2016	→	FDB2260	2		XRAC/ST/CPRO	FDB2074		ST/SM/PI/EF/CPRO/AG
Rivale	800		2013	→	FDB2265	2		ST/EF/CPRO	FDB2074		ST/SM/PI/EF/CPRO/AG
STRADALE 800	800		2015	→	FDB2265	2		ST/EF/CPRO	FDB2074		ST/SM/PI/EF/CPRO/AG
SUPERVELOCE 800	800		2019	→	FDB2042	2		ZRAC/XRAC/ST/PI/EF/CPRO	FDB2074		ST/SM/PI/EF/CPRO/AG
TURISMO VELOCE 800	800	81	2015	→	FDB2265	2		ST/EF/CPRO	FDB2074		ST/SM/PI/EF/CPRO/AG
TURISMO VELOCE 800 LUSO	800	81	2015	→	FDB2265	2		ST/EF/CPRO	FDB2074		ST/SM/PI/EF/CPRO/AG
TURISMO VELOCE 800 POLIZIA	800		2016	→	FDB2265	2		ST/EF/CPRO	FDB2074		ST/SM/PI/EF/CPRO/AG
TURISMO VELOCE RC	800		2017	→	FDB2265	2		ST/EF/CPRO	FDB2074		ST/SM/PI/EF/CPRO/AG
TURISMO VELOCE 800 Lusso SCS	800	81	2019	→	FDB2042	2		ZRAC/XRAC/ST/PI/EF/CPRO	FDB2074		ST/SM/PI/EF/CPRO/AG
TURISMO VELOCE 800 RC SCS	800	81	2019	→	FDB2042	2		ZRAC/XRAC/ST/PI/EF/CPRO	FDB2074		ST/SM/PI/EF/CPRO/AG
BRUTALE 910 R	910		2006	→ 2008	FDB2120	2		ZRAC/XRAC/ST	FDB2198		ST
BRUTALE 910 S	910		2007	→	FDB2036	2		XRAC/ST/P	FDB2198		ST
BRUTALE 920 (B53)	920		2011	→ 2012	FDB2042	2		ZRAC/XRAC/ST/PI/EF/CPRO	FDB2198		ST
BRUTALE 989 R	989		2008	→ 2009	FDB2042	2		ZRAC/XRAC/ST/PI/EF/CPRO	FDB2198		ST
BRUTALE 990 R	990		2010	→ 2011	FDB2042	2		ZRAC/XRAC/ST/PI/EF/CPRO	FDB2198		ST
Brutale 1000 RR	998		2020	→	FDB2260	2		XRAC/ST/CPRO	FDB2074		ST/SM/PI/EF/CPRO/AG
F4 1000	998		2004	→ 2006	FDB2036	2		XRAC/ST/P	FDB2198		ST
F4 1000 R	998		2006	→ 2007	FDB2120	2		ZRAC/XRAC/ST	FDB2198		ST
F4 1000 312R (Up to VIN #008064)	998		2007	→ 2007	FDB2120	2		ZRAC/XRAC/ST	FDB2198		ST
F4 1000 312R 1+1	998		2007	→ 2008	FDB2120	2		ZRAC/XRAC/ST	FDB2198		ST
F4 1000 312R (From VIN #008065)	998		2008	→ 2009	FDB2260	2		XRAC/ST/CPRO	FDB2198		ST
F4 1000 VELTRO	998		2008	→ 2008	FDB2166	2		XRAC/CPRO/CP1	FDB2198		ST
F4 1000	998		2010	→ 2015	FDB2260	2		XRAC/ST/CPRO	FDB2198		ST
F4 1000 S Freccie Tricolori	998		2010	→ 2010	FDB2260	2		XRAC/ST/CPRO	FDB2198		ST
F4 1000 R	998		2012	→	FDB2260	2		XRAC/ST/CPRO	FDB2198		ST
F4 1000 RR	998	148	2012	→	FDB2260	2		XRAC/ST/CPRO	FDB2198		ST
F4 1000 WSBK	998		2015	→	FDB2260	2		XRAC/ST/CPRO			
F4 1000 RC	998	151	2015	→	FDB2260	2		XRAC/ST/CPRO	FDB2198		ST
F4 1000 LH44	998	151	2018	→	FDB2260	2		XRAC/ST/CPRO	FDB2198		ST
F4 1000 RC Lim.ed.	998	156	2018	→	FDB2260	2		XRAC/ST/CPRO	FDB2198		ST
F4 1000 Claudio	998		2019	→	FDB2260	2		XRAC/ST/CPRO	FDB2198		ST
Rush 1000	998		2020	→	FDB2260	2		XRAC/ST/CPRO	FDB2074		ST/SM/PI/EF/CPRO/AG
BRUTALE SERIE ORO 1000	1000	152	2019	→	FDB2042	2		ZRAC/XRAC/ST/PI/EF/CPRO	FDB2074		ST/SM/PI/EF/CPRO/AG
BRUTALE 1078 RR	1078		2008	→ 2009	FDB2260	2		XRAC/ST/CPRO	FDB2198		ST
F4 100 CC	1078		2007	→ 2008	FDB2166	2		XRAC/CPRO/CP1	FDB2198		ST
F4 1078 312 RR	1078		2007	→ 2008	FDB2260	2		XRAC/ST/CPRO	FDB2198		ST
F4 1078 RR	1078		2008	→ 2011	FDB2260	2		XRAC/ST/CPRO	FDB2198		ST
BRUTALE 1090 RR	1090		2010	→	FDB2260	2		XRAC/ST/CPRO	FDB2198		ST
BRUTALE 1090 R	1090		2012	→	FDB2042	2		ZRAC/XRAC/ST/PI/EF/CPRO	FDB2198		ST
BRUTALE 1090	1090		2013	→	FDB2042	2		ZRAC/XRAC/ST/PI/EF/CPRO	FDB2198		ST

MZ

ETZ 125	125			→	FSB824				FSB824		
ETZ 125	125		1982	→ 1992	FDB108			ST/PI/EF/CPRO	FSB824		
SAXON 125	125		1993	→ 1997	FDB108			ST/PI/EF/CPRO	FSB823		
TS 125	125			→	FSB823				FSB824		
ETZ 150	150			→	FSB824				FSB824		
ETZ 150	150		1982	→ 1992	FDB108			ST/PI/EF/CPRO	FSB824		
SAXON 150	150		1995	→	FDB108			ST/PI/EF/CPRO	FSB823		
TS 150	150			→	FSB823				FSB824		
ETZ 250	250			→	FSB823				FSB823		
ETZ 250	250		1982	→ 1992	FDB148			ST/P	FSB823		
TS 250	250			→	FSB823				FSB823		

* It is recommended that in those applications where sintered pads are supplied as Original Equipment, replacement pads should also be of sintered composition.

** To avoid brake imbalance sintered pads fitted in rear calipers should only be used in combination with front calipers containing sintered pads.

1072



CC KW FROM -> TO N° SET L/R COMPOUND



N° SET L/R COMPOUND

...MZ										
FUN 251	251	1995	→ 1996	FDB108				ST/P/EF/CPRO	FSB823	
ETZ 301	301	1990	→ 1992	FDB108				ST/P/EF/CPRO	FSB823	
SAXON 500	500	1993	→ 1998	FDB108				ST/P/EF/CPRO	FSB823	
BAGHIRA / MASTIFF	660	2000	→	FDB782				P	FDB828	ST/P
SKORPION CUP / SPORT / TOUR / TRAVELLER	660	1995	→	FDB498				XRAC/ST/P	FDB207	ST/P/EF/CP1
SKORPION REPLICA	660	1995	→	FRP408				XRAC/ST/PRP/PCPRO/CP1	FDB207	ST/P/EF/CP1

NORTON										
adaptable to front 200x30 drums			→	FSB923						
COMMANDER	580	1990	→	FDB337	2			ST/P/EF	FDB337	ST/P/EF
FORMULA 1	588	1989	→ 1991	FRP408	2			XRAC/ST/PRP/PCPRO/CP1	FDB207	ST/P/EF/CP1
FORMULA 1 SPORT	588	1992	→	FRP408	2			XRAC/ST/PRP/PCPRO/CP1	FRP408	XRAC/ST/PRP/PCPRO/CP1
INTERPOL 2 (ROTARY)	588	1983	→	FDB108	2			ST/P/EF/CPRO	FDB108	ST/P/EF/CPRO
COMMANDO	750	1968	→ 1973	FSB920					FSB922	
COMMANDO	850	1973	→ 1977	FDB88				P	FDB88	P

OSSA										
CROSS 125	125	1974	→	FSB825					FSB828	
CROSS 250	250	1974	→	FSB825					FSB828	
FUEGO 250	250	1974	→	FSB825					FSB828	
TRIAL 250 (all models)	250		→ 1980	FSB825					FSB825	
TRIAL 250 (all models)	250	1981	→	FSB826					FSB827	
TRIAL 350 (all models)	350		→ 1980	FSB825					FSB825	
TRIAL 350 (all models)	350	1981	→	FSB826					FSB827	
TU-YO 360	360		→	FDB213				P	FDB213	P

PEUGEOT										
E-Vivacity (Electric)		2010	→	FDB2191				EF	FSB704	
e - Satelis		2011	→	FDB497				ST/SM/SG/P/EF	FDB497	ST/SM/SG/P/EF
e - Vivacity (Electric)		2011	→ 2012	FDB497				ST/SM/SG/P/EF	FSB704	
103 / 104 / 105 50	50		→	FSB712					FSB712	
ASV 50 (telescopic fork)	50	1993	→	FSB712					FSB712	
Blaster Iceblade 50 (2T/12" Wheels)	50	2010	→ 2012	FRP405				ST/SG/PRP/P/EF	FRP405	ST/SG/PRP/P/EF
Blaster RS 12 50 (2T)	50	2010	→ 2011	FRP405				ST/SG/PRP/P/EF	FRP405	ST/SG/PRP/P/EF
BUXI 50	50	1994	→ 1997	FDB680				ST/EF	FSB704	
BUXI RS 50	50	1994	→ 1997	FDB313				SG/P/EF	FSB704	
DJANGO 50 2T (HERITAGE)	50	2015	→	FDB497				ST/SM/SG/P/EF		
DJANGO 50 2T (SPORT-EVASION-ALLURE)	50	2015	→	FDB2256				EF		
DJANGO 50 4T (HERITAGE)	50	2015	→	FDB497				ST/SM/SG/P/EF		
DJANGO 50 4T (SPORT-EVASION-ALLURE)	50	2015	→	FDB2256				EF		
ELYSEO 50	50	1998	→ 2002	FRP405				ST/SG/PRP/P/EF	FSB704	
ELYSEO 50	50	2003	→	FRP405				ST/SG/PRP/P/EF	FRP405	ST/SG/PRP/P/EF
FOX 50	50	1996	→	FSB906					FSB704	
JET FORCE 50	50	2003	→	FRP405				ST/SG/PRP/P/EF	FRP405	ST/SG/PRP/P/EF
Jet C Tech 50	50	2011	→ 2012	FRP405				ST/SG/PRP/P/EF	FRP405	ST/SG/PRP/P/EF
Jet Darkside 50 (2T)	50	2011	→	FRP405				ST/SG/PRP/P/EF	FRP405	ST/SG/PRP/P/EF
Jet H2i 50 (2T -Air Cooled)	50	2011	→ 2012	FRP405				ST/SG/PRP/P/EF	FSB704	
Jet H2i 50 (2T-L/C)	50	2011	→ 2012	FRP405				ST/SG/PRP/P/EF	FRP405	ST/SG/PRP/P/EF
Jet Iceblade 50 (2T)	50	2011	→	FRP405				ST/SG/PRP/P/EF	FRP405	ST/SG/PRP/P/EF
Kisbee 50 (2T)	50	2010	→ 2012	FDB313				SG/P/EF		
Kisbee 50 (4T)	50	2010	→ 2012	FDB313				SG/P/EF		
Kisbee RS 50 (2T)	50	2010	→ 2012	FDB313				SG/P/EF		
Kisbee RS 50 (4T)	50	2010	→ 2012	FDB313				SG/P/EF		
LOOXOR 50	50	2001	→	FRP405				ST/SG/PRP/P/EF	FSB704	
LooXoR 50 TSDI (Rear disc)	50	2006	→	FRP405				ST/SG/PRP/P/EF	FRP405	ST/SG/PRP/P/EF
LUDIX ONE 50	50	2004	→	FSB704					FSB704	
Ludix Blaster (10" Wheels)	50	2005	→ 2009	FRP405				ST/SG/PRP/P/EF	FSB704	
Ludix Acid	50	2006	→	FRP405				ST/SG/PRP/P/EF	FSB704	
Ludix Red Zone	50	2006	→	FRP405				ST/SG/PRP/P/EF	FSB704	
Ludix Urban Track	50	2006	→ 2007	FRP405				ST/SG/PRP/P/EF	FSB704	
Ludix 2 Biposto 50cc (2T/10? wheels)	50	2007	→ 2009	FSB704					FSB704	
Ludix 2 Trend 50cc (2T/12? wheels)	50	2007	→ 2012	FRP405				ST/SG/PRP/P/EF	FSB704	
Ludix 2 One Biposoto (2T/10? Wheels)	50	2010	→ 2012	FSB704					FSB704	
Ludix 2 One Monoposoto (2T/12? Wheels)	50	2010	→ 2011	FSB704					FSB704	
Ludix Pro (4T / 14" Wheels/AJP Caliper)	50	2011	→	FRP405				ST/SG/PRP/P/EF	FSB704	
Ludix Pro (4T / 14" Wheels/J.Juan Caliper)	50	2011	→	FDB680				ST/EF	FSB704	
METROPOLIS 50	50		→	FSB704					FSB703	
New Vivacity 50cc /2T	50	2008	→ 2012	FDB250				SG/P/EF	FSB704	
New Vivacity 50cc /4T	50	2008	→ 2012	FDB250				SG/P/EF	FSB704	

* It is recommended that in those applications where sintered pads are supplied as Original Equipment, replacement pads should also be of sintered composition.
 ** To avoid brake imbalance sintered pads fitted in rear calipers should only be used in combination with front calipers containing sintered pads.



CC KW FROM -> TO N° SET L/R COMPOUND N° SET L/R COMPOUND

...PEUGEOT

New Vivacity Sixtes 50cc/4T	50	2010	→ 2012	FDB250			SG/P/EF	FSB704			
NK7 (50cc) Naked	50	2009	→ 2012	FDB2201			ST	FDB384			P
SC 50	50		→	FSB704				FSB703			
SPEEDAKE 50	50	1995	→ 2001	FDB680			ST/EF	FSB704			
SPEEDFIGHT 50 M (AJP caliper)	50	1997	→ 1998	FRP405			ST/SG/PRP/P/EF	FSB704			
SPEEDFIGHT 50 M (Heng-Tong caliper)	50	1997	→	FDB313			SG/P/EF	FSB704			
SPEEDFIGHT 50 (liquid cooled AJP caliper)	50	1998	→ 2000	FRP405			ST/SG/PRP/P/EF	FRP405			ST/SG/PRP/P/EF
Speedfight 3 (50cc A/C - 2T)	50	2009	→ 2012	FDB312			ST/P/EF	FSB704			
Speedfight 3 (50cc L/C - 2T)	50	2009	→ 2012	FDB312			ST/P/EF	FDB2074			ST/SM/P/EF/CPRO/AG
Speedfight 3 - RS (50cc L/C - 2T)	50	2009	→ 2012	FDB312			ST/P/EF	FDB2074			ST/SM/P/EF/CPRO/AG
Speedfight 3 - RS (50cc - A/C - 2T)	50	2010	→ 2012	FDB312			ST/P/EF	FDB2074			ST/SM/P/EF/CPRO/AG
Speedfight 4 AC (50cc 2T)	50	2015	→	FDB312			ST/P/EF				
Speedfight 4 AC (50cc 4T)	50	2015	→	FDB312			ST/P/EF				
Speedfight 4 LC (50cc 2T)	50	2015	→	FDB312			ST/P/EF	FDB2074			ST/SM/P/EF/CPRO/AG
Speedfight 4 LC (50cc 4T)	50	2015	→	FDB312			ST/P/EF	FDB2074			ST/SM/P/EF/CPRO/AG
SQUAB 50	50	1996	→ 2001	FRP405			ST/SG/PRP/P/EF	FSB704			
SQUAB 50 (Heng-Tong caliper)	50	1996	→ 2001	FDB313			SG/P/EF	FSB704			
ST 50	50		→	FSB702				FSB703			
ST 50 RAPIDO	50		→	FSB754				FSB754			
STL 2 50	50		→	FSB702				FSB703			
Streetzone 12 (50cc/2T)	50	2014	→	FRP405			ST/SG/PRP/P/EF				
SV 50 APS SYSTEM	50	1991	→	FSB704				FSB704			
SV 50 GEO	50	1992	→	FDB783			AG	FSB704			
SV 50 GEO (all models)	50	1993	→	FDB672			EF	FSB704			
SX 50	50		→	FSB704				FSB754			
TREKKER 50 ROAD	50	1997	→	FDB313			SG/P/EF	FSB704			
TRK 50 (2T/10? Wheels)	50	2009	→ 2012	FRP405			ST/SG/PRP/P/EF	FSB704			
TRK 50 12 (2T/12? Wheels)	50	2009	→ 2012	FRP405			ST/SG/PRP/P/EF	FSB704			
Tweet 50 (4T/Rear Drum Model)	50	2010	→ 2013	FDB2190			EF	FSB966			
Tweet 50 RS (4T/Rear Disc Model)	50	2010	→ 2012	FDB2190			EF	FDB2057			EF/AG
Tweet 50 Evo	50	2014	→	FDB2190			EF	FSB966			
Tweet 50 Evo RS	50	2014	→	FDB2190			EF	FDB2057			EF/AG
V-Clic 50 (4T)	50	2008	→ 2011	FDB636			P/EF	FSB704			
VIVACITY 2 50 .	50	1998	→ 2003	FRP405			ST/SG/PRP/P/EF	FSB704			
Vivacity 2 50	50	2008	→ 2011	FDB313			SG/P/EF	FSB704			
X FIGHT 50 (liquid cooled)	50	2000	→	FRP405			ST/SG/PRP/P/EF	FRP405			ST/SG/PRP/P/EF
X FIGHT 50 M	50	2000	→	FRP405			ST/SG/PRP/P/EF	FSB704			
XPS 50 SM	50	2009	→	FDB384			P	FDB384			P
XPS 50 Top Road (17? F/Wheel)	50	2010	→ 2012	FDB384			P	FRP405			ST/SG/PRP/P/EF
XPS 50 Track (21? F/Wheel)	50	2011	→ 2012	FDB384			P	FRP405			ST/SG/PRP/P/EF
XR 6 50	50	2002	→	FDB706			P	FRP405			ST/SG/PRP/P/EF
XR7 (50cc) Full Fairing	50	2008	→ 2012	FDB2201			ST	FDB384			P
ZENITH 50	50	1994	→ 1995	FDB783			AG	FSB704			
ZENITH 50	50	1996	→ 2000	FRP405			ST/SG/PRP/P/EF	FSB704			
SC 75	75		→	FSB704				FSB703			
SX 75	75		→	FSB704				FSB703			
METROPOLIS 80	80		→	FSB704				FSB703			
SC 80	80		→	FSB704				FSB754			
SV 80 EXECUTIVE	80	1996	→	FDB539			SG/P/EF	FSB704			
SX 80	80		→	FSB704				FSB703			
ELYSEO 100	100	1998	→	FRP405			ST/SG/PRP/P/EF	FSB704			
ELYSEO 100	100	1999	→ 2002	FRP405			ST/SG/PRP/P/EF				
ELYSEO 100	100	2003	→	FRP405			ST/SG/PRP/P/EF	FRP405			ST/SG/PRP/P/EF
Kisbee 100 (K3)	100	2013	→	FDB313			SG/P/EF	FSB966			
LOOXOR 100	100	2001	→	FRP405			ST/SG/PRP/P/EF	FRP405			ST/SG/PRP/P/EF
TREKKER 100	100	1998	→	FRP405			ST/SG/PRP/P/EF	FSB704			
VIVACITY 100 .	100	1998	→	FRP405			ST/SG/PRP/P/EF	FSB704			
X FIGHT 100 (liquid cooled)	100	2000	→	FRP405			ST/SG/PRP/P/EF	FRP405			ST/SG/PRP/P/EF
X FIGHT 100 M	100	2000	→	FRP405			ST/SG/PRP/P/EF	FSB704			
City Star 125 (AC/Carb)	125	2011	→	FDB497			ST/SM/SG/P/EF	FDB2057			EF/AG
City Star 125 i (LC)	125	2013	→	FDB497			ST/SM/SG/P/EF	FDB2057			EF/AG
City Star 125 Blue Line (AC/Carb)	125	2015	→	FDB497			ST/SM/SG/P/EF	FDB314			ST/SG/P/EF
DJANGO 125 (ALLURE)	125	2014	→	FDB2256			EF	FDB314			ST/SG/P/EF
DJANGO 125 (EVASION)	125	2014	→	FDB2256			EF	FDB314			ST/SG/P/EF
DJANGO 125 (HERITAGE)	125	2014	→	FDB497			ST/SM/SG/P/EF	FDB2074			ST/SM/P/EF/CPRO/AG
DJANGO 125 (SPORT)	125	2014	→	FDB2256			EF	FDB314			ST/SG/P/EF
ELYSEO 125	125	1998	→ 2000	FRP405			ST/SG/PRP/P/EF	FSB762			
ELYSEO 125	125	2001	→ 2002	FDB2128			EF				
ELYSEO 125	125	2003	→	FDB677			P/EF	FDB2128			EF
Elystar 125 (5 bolt fixing front disc)	125	2006	→ 2007	FDB677			P/EF	FDB2128			EF
Geo RS 125 (Nissin Calipers)	125	2007	→ 2012	FDB497			ST/SM/SG/P/EF	FDB497			ST/SM/SG/P/EF
Geopolis 125 (AJP Caliper/ABS)	125	2007	→ 2012	FDB677			P/EF	FDB2128			EF
Geopolis 125 Executive (AJP Caliper/Non ABS)	125	2007	→ 2012	FDB677			P/EF	FDB2128			EF
Geopolis 125 Premium (Nissin Caliper/Non ABS)	125	2007	→ 2012	FDB497			ST/SM/SG/P/EF	FDB497			ST/SM/SG/P/EF

* It is recommended that in those applications where sintered pads are supplied as Original Equipment, replacement pads should also be of sintered composition.

** To avoid brake imbalance sintered pads fitted in rear calipers should only be used in combination with front calipers containing sintered pads.



	CC	KW	FROM -> TO		N° SET	L/R	COMPOUND		N° SET	L/R	COMPOUND	
...PEUGEOT												
Geopolis 125 Urban (AJP Caliper/ ABS)	125		2007 → 2012	FDB677			P/EF		FDB2128		EF	
LOOXOR 125 / 150	125		2003 →	FDB2105			EF/AG		FRP405		ST/SG/PRP/P/EF	
LUDIX 125	125		2004 →	FRP405			ST/SG/PRP/P/EF		FSB704			
LXR 125 (4T)	125		2010 → 2012	FDB2190			EF		FDB2226		EF/AG	
SATELIS 125	125		2004 → 2005	FDB570			XRAC/ST/SM/P/EF/CPRO		FDB2128		EF	
SATELIS 125	125		2006 →	FDB677			P/EF		FRP405		ST/SG/PRP/P/EF	
Satelis 125 4V Executive/Premium/City	125		2006 → 2009	FDB677			P/EF		FDB2128		EF	
Satelis 125 Compressor (4T)	125		2006 → 2011	FDB677			P/EF		FDB2128		EF	
Satelis 125 RS (AJP Caliper)	125		2007 → 2011	FDB677			P/EF		FDB2128		EF	
Satelis 125 Urban (AJP Caliper/ABS)	125		2007 → 2011	FDB677			P/EF		FDB2128		EF	
Satelis 125 Avenue (Nissin Calipers)	125		2008 → 2009	FDB497			ST/SM/SG/P/EF		FDB497		ST/SM/SG/P/EF	
Satelis 125 Blacksats (AJP Calipers)	125		2010 → 2011	FDB677			P/EF		FDB2128		EF	
Satelis 125 Whitesat (AJP Calipers)	125		2010 → 2011	FDB677			P/EF		FDB2128		EF	
SATELIS 125	125		2013 →	FDB2256			EF		FDB2057		EF/AG	
SATELIS 125 RS (4T)	125		2013 →	FDB497			ST/SM/SG/P/EF		FDB2057		EF/AG	
Speedfight 125	125		2013 →	FDB312			ST/P/EF		FDB2074		ST/SM/P/EF/CPRO/AG	
Sum-Up (125cc)	125		2008 → 2011	FDB250			SG/P/EF		FSB731			
SV 125 GEO	125		1991 → 1992	FDB783			AG		FSB704			
SV 125 GEO	125		1993 →	FDB672			EF		FSB704			
Tweet 125 Evo (4T/Rear Drum Model) (LW2)	125	6	2010 →	FDB2190			EF		FSB731			
Tweet 125 Evo RS (4T/Rear Disc Model)	125	6	2011 →	FDB2190			EF		FDB2057		EF/AG	
Vivacity 125 (4T)	125		2010 → 2012	FDB497			ST/SM/SG/P/EF		FSB731			
Vivacity Sixties 125 (4T)	125		2011 → 2012	FDB497			ST/SM/SG/P/EF		FSB731			
WTR 125	125		2008 → 2008	FDB2087			EF					
XP 125 Street Evo 2	125		2005 →	FDB706			P		FRP405		ST/SG/PRP/P/EF	
XPS 125 CT	125		2005 → 2007	FRP405			ST/SG/PRP/P/EF		FRP405		ST/SG/PRP/P/EF	
City Star 151 (AC/Carb)	150		2011 →	FDB497			ST/SM/SG/P/EF		FDB2057		EF/AG	
DJANGO 150 (ALLURE)	150		2014 →	FDB2256			EF		FDB314		ST/SG/P/EF	
DJANGO 150 (EVASION)	150		2014 →	FDB2256			EF		FDB314		ST/SG/P/EF	
DJANGO 150 (HERITAGE)	150		2014 →	FDB497			ST/SM/SG/P/EF		FDB2074		ST/SM/P/EF/CPRO/AG	
DJANGO 150 (SPORT)	150		2014 →	FDB2256			EF		FDB314		ST/SG/P/EF	
ELYSEO 150	150		2000 →	FRP405			ST/SG/PRP/P/EF		FDB2128		EF	
ELYSEO 150	150		2001 →	FDB677			P/EF		FDB2128		EF	
Elystar 150 (5 bolt fixing front disc)	150		2006 → 2007	FDB677			P/EF		FDB2128		EF	
Tweet 150 (4T/Rear Drum Model)	150	8	2010 → 2011	FDB2190			EF		FSB731			
Tweet 150 RS (4T/Rear Disc Model)	150		2011 →	FDB2190			EF		FDB2057		EF/AG	
City Star 200 i	200		2012 →	FDB497			ST/SM/SG/P/EF		FDB2057		EF/AG	
LXR 200i (4T)	200		2010 → 2011	FDB2190			EF		FDB2226		EF/AG	
Geo 250 (Nissin Caliper)	250		2007 → 2011	FDB497			ST/SM/SG/P/EF		FDB497		ST/SM/SG/P/EF	
Geopolis 250 Executive (AJP caliper/ Non ABS)	250		2007 → 2011	FDB677			P/EF		FDB2128		EF	
Geopolis 250 Premium (Nissin caliper/ Non ABS)	250		2007 → 2011	FDB497			ST/SM/SG/P/EF		FDB497		ST/SM/SG/P/EF	
Geopolis 250 Urban (AJP caliper/ ABS)	250		2007 → 2011	FDB677			P/EF		FDB2128		EF	
Satelis 250 Premium (Nissin Calipers)	250		2007 → 2012	FDB497			ST/SM/SG/P/EF		FDB497		ST/SM/SG/P/EF	
Satelis 250 RS (Nissin Calipers)	250		2007 → 2012	FDB497			ST/SM/SG/P/EF		FDB497		ST/SM/SG/P/EF	
Satelis 250 Urban (AJP Caliper/ABS)	250		2007 → 2012	FDB677			P/EF		FDB2128		EF	
SV 250	250		2001 →	FDB2075			ST/SM/P/EF		FDB531		ST/P/EF	
Geopolis 300 (Nissin Calipers/Non ABS)	300		2010 → 2013	FDB497			ST/SM/SG/P/EF		FDB497		ST/SM/SG/P/EF	
Geopolis 300 RS (Nissin Calipers)	300		2010 → 2013	FDB497			ST/SM/SG/P/EF		FDB497		ST/SM/SG/P/EF	
Geopolis 300 Style (Nissin Calipers)	300		2010 → 2013	FDB497			ST/SM/SG/P/EF		FDB497		ST/SM/SG/P/EF	
Geo RS 400 (Nissin Calipers)	400		2008 → 2012	FDB497			ST/SM/SG/P/EF		FDB497		ST/SM/SG/P/EF	
Geopolis 400 Premium (Nissin Caliper/ Non ABS)	400		2007 → 2012	FDB497			ST/SM/SG/P/EF		FDB497		ST/SM/SG/P/EF	
Geopolis 400 Urban (AJP Caliper/ ABS)	400		2007 → 2012	FDB677			P/EF		FDB2128		EF	
Metropolis RS	400		2014 →	FDB2055	2		SG		FDB2055		SG	
Metropolis RS Parking Brake	400		2014 →						FDB313		SG/P/EF	
Metropolis SPORT	400		2014 →	FDB2055	2		SG		FDB2055		SG	
Metropolis SPORT Parking Brake	400		2014 →						FDB313		SG/P/EF	
Metropolis GT Connect	400		2015 →	FDB2055	2		SG		FDB2055		SG	
Metropolis GT Connect Parking Brake	400		2015 →						FDB313		SG/P/EF	
Satelis 400 Premium (Nissin Calipers)	400		2008 → 2013	FDB570	2		XRAC/ST/SM/P/EF/CPRO		FDB497		ST/SM/SG/P/EF	
Satelis 400 RS (Nissin Calipers)	400		2008 → 2013	FDB570	2		XRAC/ST/SM/P/EF/CPRO		FDB497		ST/SM/SG/P/EF	
Satelis 400 Urban (Nissin Calipers)	400		2008 → 2012	FDB570	2		XRAC/ST/SM/P/EF/CPRO		FDB497		ST/SM/SG/P/EF	
Geopolis 500	500		2008 → 2011	FDB570	2		XRAC/ST/SM/P/EF/CPRO		FDB497		ST/SM/SG/P/EF	
Satelis 500	500		2007 → 2012	FDB570	2		XRAC/ST/SM/P/EF/CPRO		FDB497		ST/SM/SG/P/EF	
Satelis 500 RS (Nissin Calipers)	500		2008 → 2012	FDB570	2		XRAC/ST/SM/P/EF/CPRO		FDB497		ST/SM/SG/P/EF	
SATELIS 600	600		2004 → 2005	FDB570			XRAC/ST/SM/P/EF/CPRO		FDB2128		EF	
XPS 6 SUPERMOTARD	600		2003 →	FDB706			P		FRP405		ST/SG/PRP/P/EF	
PGO												
i-Dep Electric Scooter			2009 →	FDB2190			EF		FDB2190		EF	
BIG MAX 50	50		1995 → 2004	FDB636			P/EF		FSB883			
BIG MAX 50 S	50		2003 → 2004	FDB2190			EF		FSB883			
Big Max 50 (Front wave disc)	50		2007 → 2009	FDB2190			EF		FSB883			

* It is recommended that in those applications where sintered pads are supplied as Original Equipment, replacement pads should also be of sintered composition.

** To avoid brake imbalance sintered pads fitted in rear calipers should only be used in combination with front calipers containing sintered pads.



CC KW FROM -> TO N° SET L/R COMPOUND N° SET L/R COMPOUND

...PGO

Big Max 50 Naked	50	2007	→ 2009	FDB2190			EF	FSB883		
COMET 50	50	1991	→	FDB313			SG/P/EF	FSB883		
EPS	50	1997	→	FDB636			P/EF	FSB883		
G-Max 50	50	2005	→ 2007	FDB2190			EF	FSB883		
G-Max 50 (Wave disc)	50	2008	→ 2012	FDB2190			EF	FSB883		
G-Max 50 Naked (Wave disc)	50	2009	→	FDB2190			EF	FSB883		
GALAXI 50	50	1992	→	FDB313			SG/P/EF	FSB883		
Libra 50 (2T)	50	2009	→ 2009	FDB2190			EF			
Ligero 50 (2T)	50	2008	→ 2012	FDB2190			EF	FSB883		
Mega 50	50	1994	→	FDB313			SG/P/EF	FSB883		
MY BUBU 50	50	2003	→	FDB889			ST/EF	FSB731		
PMX 50	50	2000	→ 2004	FDB2190			EF	FSB883		
PS 50	50	1993	→	FDB313			SG/P/EF	FSB883		
Rodo Show 50	50	2000	→ 2009	FDB680			ST/EF	FSB883		
STAR 50	50		→ 1993	FSB704				FSB703		
STAR 2 50	50	1994	→	FSB704				FSB703		
SUPER FIFTY 50 (BRASIL)	50		→					FSB883		
T-REX 50	50	1999	→ 2004	FDB2190			EF	FSB777		
Tornado 50	50	1997	→	FDB636			P/EF	FSB883		
BIG MAX 80	80		→	FSB704				FSB703		
STAR 80	80	1990	→	FSB704				FSB703		
GALAXI 90	90	1992	→	FDB313			SG/P/EF	FSB883		
Bubu 100	100	2003	→ 2008	FDB2190			EF	FSB721		
My Bubu 100	100	2003	→ 2005	FDB2190			EF	FSB721		
PMX 110	110	2000	→ 2004	FDB2190			EF	FSB883		
T-REX 110	110	1999	→ 2004	FDB2190			EF	FSB777		
Bubu 125	125	2003	→ 2008	FDB2190			EF	FSB721		
CHARGE 125 A / B	125	2001	→ 2002	FDB2190			EF	FSB777		
G-Max 125	125	2006	→ 2008	FDB352			ST/P	FDB2087		EF
G-Max 125 (Wave disc)	125	2009	→ 2012	FDB352			ST/P	FDB2087		EF
I-CHARGE 125	125	2003	→ 2004	FDB2190			EF	FSB721		
Libra 125 EFI (4T)	125	2009	→ 2012	FDB2190			EF			
Ligero 125	125	2006	→ 2008	FDB2190			EF	FSB777		
Ligero 125 (4T)	125	2008	→ 2012	FDB2190			EF	FSB777		
MY BUBU 100 / 125	125	2003	→ 2004	FDB2190			EF	FSB721		
T-REX 125	125	1999	→ 2004	FDB2190			EF	FSB721		
T/Rex 125	125	1999	→ 2007	FDB2190			EF	FSB721		
Tigra125 (4T/4V)	125	2012	→	FDB2190			EF	FDB2057		EF/AG
Tornado 125	125	1997	→	FDB636			P/EF	FSB883		
YOUNG BUBU 125	125	2003	→ 2004	FDB2190			EF	FSB721		
Libra 150 (4T)	150	2009	→ 2009	FDB2190			EF			
T-REX 150	150	1999	→ 2004	FDB2190			EF	FSB721		
TR-3 150cc (3 wheeler)	150	2003	→ 2009	FDB2190			EF			
G-Max 250	250	2006	→ 2008	FDB352			ST/P	FDB2087		EF

PIAGGIO

Liberty Elettrico			2011 → 2012	FDB2057			EF/AG	FSB954		
Vespa Electric	3	2020	→	FDB2115			P/EF			
BOSS 50	50	1988	→	FSB908				FSB889		
BOXER 50	50		→	FSB902				FSB889		
BRAVO 50	50		→	FSB902				FSB889		
BRAVO 50 (alloy wheels 90mm hub)	50	1987	→	FSB908				FSB889		
BRAVO 50 (alloy wheels)	50	1987	→	FSB910				FSB889		
CIAO 50	50		→	FSB902				FSB889		
CIAO 50 (alloy wheels)	50	1987	→	FSB910				FSB889		
CIAO 50 MIX	50	1997	→	FSB952				FSB889		
FLY 50 2T	50	2005	→	FDB2142			ST/SM/EF/AG	FSB954		
FLY 50 4T	50	2005	→	FDB2142			ST/SM/EF/AG	FSB954		
FREE 50	50	1993	→ 1995	FSB902				FSB915		
FREE 50	50	1996	→ 2000	FDB697			EF	FSB940		
FREE 50 (alloy wheels)	50	1996	→ 2000	FSB915				FSB895		
FREE Delivery 50	50	2000	→ 2001	FDB697			EF	FSB940		
FREE 50	50	2002	→	FDB680			ST/EF	FSB938		
GRILLO 50	50	1989	→	FSB910				FSB889		
LIBERTY 50	50	1997	→ 2003	FDB2057			EF/AG	FSB954		
Liberty Sport 50 2T	50	2007	→ 2008	FDB2057			EF/AG	FSB954		
Liberty Sport 50 4T	50	2007	→ 2008	FDB680			ST/EF	FDB680		ST/EF
Liberty 50 (2T / 10 Spoke Cast Wheels)	50	2009	→ 2013	FDB2142			ST/SM/EF/AG	FSB954		
Liberty 50 (4T / 10 Spoke Cast Wheels)	50	2009	→ 2013	FDB2142			ST/SM/EF/AG	FSB954		
NRG 50 POWER DD / Silver Bullet	50	2005	→	FDB313			SG/P/EF	FDB2057		EF/AG
NRG 50 POWER DT	50	2005	→ 2007	FDB313			SG/P/EF	FSB938		
NRG 50	50	1994	→ 1995	FDB680			ST/EF	FSB895		

* It is recommended that in those applications where sintered pads are supplied as Original Equipment, replacement pads should also be of sintered composition.

** To avoid brake imbalance sintered pads fitted in rear calipers should only be used in combination with front calipers containing sintered pads.



CC KW FROM -> TO N° SET L/R COMPOUND N° SET L/R COMPOUND

...PIAGGIO

NRG 50	50	1996 → 1997	FDB680			ST/EF	FSB940		
NRG 50 MC2	50	1996 → 1997	FDB680			ST/EF	FSB940		
NRG 50 MC2	50	1998 →	FDB680			ST/EF	FSB938		
NRG 50 MC2 DD	50	1998 →	FDB680			ST/EF	FDB2057		EF/AG
NRG 50 EXTREME (Rear disc model)	50	1999 → 2001	FDB680			ST/EF	FDB2057		EF/AG
NRG 50 EXTREME (Rear drum model)	50	1999 → 2001	FDB680			ST/EF	FSB938		
NRG 50 DT MC3 (Rear drum model)	50	2001 → 2005	FDB680			ST/EF	FSB938		
NRG 50 MC3 DD (Rear disc model)	50	2001 → 2005	FDB680			ST/EF	FDB2057		EF/AG
NRG 50 Power Pure Jet	50	2004 → 2010	FDB313			SG/P/EF	FDB2057		EF/AG
NRG 50 Power DD	50	2005 → 2013	FDB313			SG/P/EF	FDB2057		EF/AG
NRG 50 Power DT	50	2005 → 2013	FDB313			SG/P/EF	FSB938		
NRG 50 Silver Bullet	50	2010 → 2010	FDB313			SG/P/EF	FDB2057		EF/AG
NTT 50	50	→ 1995	FDB680			ST/EF	FSB895		
NTT 50	50	1996 →	FDB680			ST/EF	FSB940		
P1 50	50	1994 →	FSB937				FSB937		
QUARTZ 50	50	1992 → 1996	FDB784			EF/AG	FSB895		
SCATTO 50	50	1990 → 1993	FSB896				FSB896		
SFERA 50	50	1991 → 1994	FSB894				FSB895		
SFERA 50 RST	50	1995 → 1997	FDB2037			AG	FSB940		
SI 50	50	→	FSB902				FSB889		
SI 50 (alloy wheels)	50	1980 →	FSB910				FSB889		
SI 50 MIX	50	1997 →	FSB952				FSB889		
SUPER BRAVO 50	50	1985 →	FSB902				FSB889		
SUPERBRAVO 50 3 Marce	50	1987 →	FSB910				FSB888		
TPH 50 X-R	50	2005 →	FDB680			ST/EF			
TYPHOON 50	50	1993 → 1999	FDB680			ST/EF	FSB940		
TYPHOON XR 50	50	2000 → 2007	FDB680			ST/EF	FSB938		
Typhoon 50 (2T/12" Wheels)	50	2010 → 2012	FDB2142			ST/SM/EF/AG	FSB954		
VELOFAX 50	50	1996 →	FSB938				FSB951		
VESPA 50 PK XL 2	50	→	FSB874				FSB874		
VESPA 50 PK XL 2 AUTOMATICA	50	→	FSB874				FSB887		
VESPA 50 SPECIAL	50	→	FSB890				FSB891		
VESPA 50	50	1963 →	FSB890				FSB885		
VESPA 50 PK SPECIAL - XL	50	1986 → 1989	FSB890				FSB874		
VESPA 50 V FL 2	50	1990 → 1996	FSB874				FSB874		
VESPA 50 HP	50	1992 → 1996	FSB874				FSB874		
VESPA 50 ET2	50	1997 → 1998	FDB2057			EF/AG	FSB938		
VESPA 50 ET4	50	1999 →	FDB2057			EF/AG	FSB938		
VESPA LX 50 2T	50	2005 →	FDB2057			EF/AG	FSB938		
VESPA LX 50 4T	50	2005 →	FDB2057			EF/AG	FSB938		
Vespa LXV 50	50	2007 → 2009	FDB2057			EF/AG	FSB938		
VESPA S 50 (2T)	50	2007 → 2013	FDB2057			EF/AG	FSB938		
VESPA S 50 (4T/4V)	50	2008 → 2013	FDB2057			EF/AG	FSB938		
VESPA LX 50 2T TOURING	50	2010 →	FDB2057			EF/AG	FSB938		
VESPA LX 50 4T TOURING	50	2010 →	FDB2057			EF/AG	FSB938		
VESPA S 50 Sport (2T)	50	2011 → 2013	FDB2057			EF/AG	FSB938		
VESPA S 50 Sport (4T/4V)	50	2011 → 2013	FDB2057			EF/AG	FSB938		
VESPA PRIMAVERA 50 2T	50	2014 →	FDB2142			ST/SM/EF/AG	FSB954		
VESPA PRIMAVERA 50 4T 4V	50	2014 →	FDB2142			ST/SM/EF/AG	FSB954		
VESPA SPRINT 125 (4T 3V) i.e. ABS	50	2014 →	FDB2142			ST/SM/EF/AG	FSB938		
VESPA SPRINT 50 (2T 2V)	50	2014 →	FDB2142			ST/SM/EF/AG	FSB938		
VESPA SPRINT 50 (4T 4V)	50	2014 →	FDB2142			ST/SM/EF/AG	FSB938		
VESPINO 50 (Spain)	50	→ 1979	FSB902				FSB912		
VESPINO 50 (Spain)	50	1980 →	FSB910				FSB912		
XR 50	50	2000 →	FDB680			ST/EF	FSB938		
ZIP 50	50	1992 → 1996	FSB915				FSB895		
ZIP 50 FAST RIDER	50	1993 → 1997	FDB680			ST/EF	FSB940		
ZIP 50 BASE (Disc)	50	1995 → 1996	FDB680			ST/EF	FSB938		
ZIP 50 RST	50	1996 → 1997	FDB2057			EF/AG	FSB938		
ZIP 50 SP	50	1996 → 2000	FDB2057			EF/AG	FSB938		
ZIP 50 RST	50	1998 → 1999	FDB2057			EF/AG	FSB952		
ZIP 50	50	1999 →	FSB952				FSB938		
ZIP 50 Grimeca/Heng Tong A/C 4T	50	2000 → 2008	FDB2057			EF/AG	FSB938		
ZIP 50 SP	50	2001 → 2006	FDB2057			EF/AG	FSB938		
ZIP 50 Electric	50	2002 →	FDB680			ST/EF	FSB940		
ZUM 50	50	1991 → 1996	FSB896				FSB896		
SFERA 80	80	1994 → 1996	FSB894				FSB895		
SKIPPER 80	80	1994 → 1996	FDB784			EF/AG	FSB895		
TYPHOON 80	80	1993 → 1996	FDB680			ST/EF	FSB940		
VESPA 80 (Spain)	80	→	FSB890				FSB874		
VESPA 80 PX (Spain)	80	→	FSB890				FSB874		
VESPA 80 SPECIAL (Spain)	80	→	FSB890				FSB874		
VESPA 90 PRIMAVERA	90	1958 →	FSB890				FSB891		
Fly 100 (4T)	100	2007 → 2012	FDB2142			ST/SM/EF/AG	FSB954		

* It is recommended that in those applications where sintered pads are supplied as Original Equipment, replacement pads should also be of sintered composition.

** To avoid brake imbalance sintered pads fitted in rear calipers should only be used in combination with front calipers containing sintered pads.



CC KW FROM -> TO N° SET L/R COMPOUND N° SET L/R COMPOUND

...PIAGGIO

FREE 100	100	2002	→	FDB680			ST/EF	FSB954			
Zip 100	100	2007	→	FDB2057			EF/AG	FSB938			
Beverly 125 (M28) - Grimeca caliper	125	11	2001 → 2006	FDB677			P/EF	FDB677			P/EF
Beverly 125 (M28) - Heng Tong caliper	125	11	2001 → 2006	FDB2142			ST/SM/EF/AG	FDB2142			ST/SM/EF/AG
Beverly 125	125	2007	→ 2007	FDB2142			ST/SM/EF/AG				
Beverly S 125	125	2007	→ 2007	FDB2142			ST/SM/EF/AG	FDB2142			ST/SM/EF/AG
Beverly Tourer 125 (M28)	125	11	2008 → 2009	FDB2142			ST/SM/EF/AG	FDB2142			ST/SM/EF/AG
Beverly RST 125 i.e. (4T 4V)(M69)	125	11	2010 → 2014	FDB2142			ST/SM/EF/AG	FDB2186			SM/EF/AG
CARNABY 125	125	2008	→	FDB2142			ST/SM/EF/AG	FDB2142			ST/SM/EF/AG
COSA 125	125	1989	→ 1991	FSB893				FSB892			
COSA 2 125	125	1992	→ 1997	FSB893				FSB892			
FLY 125	125	2004	→ 2006	FDB2142			ST/SM/EF/AG	FSB954			
HEXAGON 125	125	1994	→ 1997	FDB680			ST/EF	FSB938			
HEXAGON 125 LX	125	1998	→ 1999	FDB677			P/EF	FSB954			
Liberty 125 (5 Spoke wheels)(M11)	125	7	1998 → 2003	FDB2057			EF/AG	FSB954			
Liberty 125 4T 2V (10 Spoke Cast Wheels)(M38)	125	8	2004 → 2012	FDB2057			EF/AG	FSB954			
Liberty Sport 125	125	2006	→ 2008	FDB2057			EF/AG	FSB954			
Liberty 125 4T 3V i.e. (10 Spoke Cast Wheels)(M73)	125	8	2013 →	FDB2057			EF/AG	FSB954			
Liberty 125 4T 3V i-get ABS	125	8	2016 →	FDB2242			P/EF	FSB954			
Medley 125 i-get ABS (MA0A)	125	9	2016 →	FDB2242			P/EF	FDB2186			SM/EF/AG
MP3 125 ie	125	2006	→	FDB2057	2		EF/AG	FDB2207			EF
MP3 Hybrid 125	125	2010	→	FDB2057	2		EF/AG	FDB2186			SM/EF/AG
SFERA 125	125	1995	→ 1997	FDB2037			AG	FSB938			
SFERA 125 (4 stroke)	125	1996	→	FDB2057			EF/AG	FSB938			
SKIPPER 125	125	1993	→ 1997	FDB784			EF/AG	FSB938			
SKIPPER 125 ST 4T	125	1998	→ 1999	FDB677			P/EF	FSB954			
SKIPPER ST 125 (Grimeca caliper)	125	2000	→	FDB677			P/EF	FSB954			
SKIPPER ST 125 (Heng Tong caliper)	125	2000	→	FDB2142			ST/SM/EF/AG	FSB954			
SUPER HEXAGON 125 GTX	125	2001	→	FDB2142			ST/SM/EF/AG	FDB2115			P/EF
TYPHOON 125 / XR 125	125	1995	→ 2000	FDB680			ST/EF	FSB938			
TYPHOON 125 / XR 125	125	1999	→ 2003	FDB680			ST/EF	FSB954			
Typhoon 125 (4T/12" Wheels)	125	2010	→ 2012	FDB2142			ST/SM/EF/AG	FSB954			
VESPA 125 ET3	125		→	FSB890				FSB891			
VESPA 125 PK XL 2	125		→	FSB874				FSB874			
VESPA 125	125	1951	→ 1962	FSB890				FSB875			
VESPA 125	125	1963	→ 1972	FSB890				FSB873			
VESPA 125 PRIMAVERA	125	1967	→ 1983	FSB890				FSB891			
VESPA 125 PX	125	1978	→ 1982	FSB874				FSB874			
VESPA 125 PX ARCOBALENO	125	1981	→ 1997	FSB874				FSB874			
VESPA 125 PK AUTOMATICA	125	1984	→	FSB874				FSB887			
VESPA 125 PK SPECIAL - XL	125	1986	→	FSB874				FSB874			
VESPA 125 V FL2	125	1991	→ 1997	FSB874				FSB874			
VESPA 125 ET4	125	1996	→	FDB2057			EF/AG	FSB938			
VESPA 125 PX	125	1998	→ 2013	FDB2100			EF	FSB874			
VESPA GRANTURISMO 125 (Grimeca caliper)	125	2003	→	FDB677			P/EF	FDB2115			P/EF
VESPA GRANTURISMO 125 (Heng Tong caliper)	125	2003	→	FDB2142			ST/SM/EF/AG	FDB2115			P/EF
VESPA LXV 125 / LX 125 / LXW 125 / Touring	125	2005	→ 2013	FDB2057			EF/AG	FSB938			
Vespa GTS 125	125	2007	→ 2011	FDB2142			ST/SM/EF/AG	FDB2115			P/EF
Vespa GTV 125	125	2007	→ 2009	FDB2142			ST/SM/EF/AG	FDB2115			P/EF
Vespa S 125 (4T)	125	2007	→ 2013	FDB2057			EF/AG	FSB938			
Vespa GTS 125 Super 4T i.e.	125	2010	→ 2013	FDB2142			ST/SM/EF/AG	FDB2115			P/EF
Vespa S 125 Sport (4T)	125	2011	→ 2013	FDB2057			EF/AG	FSB938			
VESPA 946 Special - 125 (4T/3V)	125	2013	→	FDB497			ST/SM/SG/P/EF	FDB2115			P/EF
Vespa GTS 125 i.e. Supersport	125	2013	→ 2013	FDB2142			ST/SM/EF/AG	FDB2115			P/EF
VESPA PRIMAVERA 125 4T 3V i.e.	125	2013	→	FDB2142			ST/SM/EF/AG	FSB954			
Vespa GTS 125 Super 4T i.e. ABS	125	2015	→	FDB2142			ST/SM/EF/AG	FDB2115			P/EF
VESPA PRIMAVERA 125 4T 3V i.e. ABS	125	2015	→	FDB2142			ST/SM/EF/AG	FSB954			
VESPA 125 GTS i.e. ABS E4	125	2016	→ 2017	FDB2142			ST/SM/EF/AG	FDB2115			P/EF
Vespa GTS 125 Liquid cooled	125	2017	→	FDB2142			ST/SM/EF/AG	FDB2115			P/EF
X9 125	125	2001	→ 2002	FDB2074	2		ST/SM/P/EF/CPRO/AG	FDB2074			ST/SM/P/EF/CPRO/AG
X9 125 Evolution	125	2004	→	FDB2142		left	ST/SM/EF/AG				
X9 125 Evolution	125	2004	→	FDB2186		right	SM/EF/AG				
X9 125 Evolution	125	2004	→					FDB2074			ST/SM/P/EF/CPRO/AG
X8 125	125	2005	→	FDB2142			ST/SM/EF/AG	FDB2207			EF
X8 125 ie	125	2007	→	FDB2142			ST/SM/EF/AG	FDB2207			EF
X7 125cc	125	2008	→ 2009	FDB2142			ST/SM/EF/AG	FDB2186			SM/EF/AG
X7 Evo 125 ie (EFi)	125	2009	→ 2012	FDB2142			ST/SM/EF/AG	FDB2186			SM/EF/AG
X10 125 i.e. (4T 4V)	125	2012	→	FDB2142		left	ST/SM/EF/AG				
X10 125 i.e. (4T 4V)	125	2012	→	FDB2186		right	SM/EF/AG				
X10 125 i.e. (4T 4V)	125	2012	→					FDB2186			SM/EF/AG
X10 EXECUTIVE (ABS-ASR) 125 i.e. (4T 4V)	125	2013	→	FDB2142		left	ST/SM/EF/AG				
X10 EXECUTIVE (ABS-ASR) 125 i.e. (4T 4V)	125	2013	→	FDB2186		right	SM/EF/AG				
X10 EXECUTIVE (ABS-ASR) 125 i.e. (4T 4V)	125	2013	→					FDB2186			SM/EF/AG
Xevo 125	125	2007	→ 2012	FDB2142			ST/SM/EF/AG	FDB2186			SM/EF/AG

* It is recommended that in those applications where sintered pads are supplied as Original Equipment, replacement pads should also be of sintered composition.

** To avoid brake imbalance sintered pads fitted in rear calipers should only be used in combination with front calipers containing sintered pads.



			CC	KW	FROM -> TO		N° SET	L/R	COMPOUND		N° SET	L/R	COMPOUND
...PIAGGIO													
125 ie MP3 Yourban	125	2011 → 2012				FDB2057	2		EF/AG		FDB2186		SM/EF/AG
ZIP 125	125	2000 →				FDB2057			EF/AG		FSB938		
COSA 150	150	1989 → 1991				FSB893					FSB892		
COSA 2 150	150	1992 → 1997				FSB893					FSB892		
FLY 150	150	2006 → 2008				FDB2142			ST/SM/EF/AG				
HEXAGON 150	150	1994 → 1999				FDB680			ST/EF		FSB938		
LIBERTY 150 (5 Spoke Wheels)	150	9 2000 → 2003				FDB2057			EF/AG		FSB954		
LIBERTY 150 4T (5 Spoke Wheels)	150	2008 → 2008				FDB2057			EF/AG		FSB954		
Liberty 150 4T (10 Spoke Cast Wheels)(M67)	150	9 2009 → 2012				FDB2057			EF/AG		FSB954		
Liberty 150 i.e. 4T 3V (10 Spoke Cast Wheels)(M73)	150	8 2013 →				FDB2057			EF/AG		FSB954		
Liberty 150 4T 3V i-get ABS	150	2016 →				FDB2242			P/EF		FSB954		
Medley 150 i-get ABS	150	11 2016 →				FDB2242			P/EF		FDB2186		SM/EF/AG
SKIPPER 150	150	1993 → 1997				FDB784			EF/AG		FSB938		
SKIPPER 150 ST 4T	150	1998 → 1999				FDB677			P/EF		FSB954		
SKIPPER ST 150 (Grimeca caliper)	150	2000 →				FDB677			P/EF		FSB954		
SKIPPER ST 150 (Heng Tong caliper)	150	2000 →				FDB2142			ST/SM/EF/AG		FSB954		
SUPER HEXAGON 150 GTX	150	2001 →				FDB2142			ST/SM/EF/AG		FDB2115		P/EF
VESPA 150 PX (Spain)	150	→				FSB874					FSB874		
VESPA 150 SPRINT VELOCE	150	→				FSB869					FSB874		
VESPA 150 SUPER	150	→				FSB890					FSB879		
VESPA 150	150	1951 → 1962				FSB890					FSB875		
VESPA 150	150	1963 → 1972				FSB890					FSB873		
VESPA 150 PX	150	1978 → 1982				FSB874					FSB874		
VESPA 150 PX ARCOBALENO	150	1983 → 1990				FSB874					FSB874		
VESPA 150 ET4	150	1996 →				FDB2057			EF/AG		FSB938		
VESPA 150 PX	150	1998 →				FDB2100			EF		FSB874		
VESPA LX 150	150	2005 →				FDB2057			EF/AG		FSB938		
VESPA S 150 (4T)	150	2007 → 2013				FDB2057			EF/AG		FSB938		
VESPA S 150 Sport (4T)	150	2011 → 2012				FDB2057			EF/AG		FSB938		
VESPA LX 150 (Serie Speciali/4T)	150	2012 →				FDB2057			EF/AG		FSB938		
VESPA PRIMAVERA 150 3V	150	2014 →				FDB2142			ST/SM/EF/AG		FSB954		
VESPA 150 GTS i.e. ABS E4	150	2016 → 2017				FDB2142			ST/SM/EF/AG		FDB2115		P/EF
VESPA 160 GS	160	→				FSB869					FSB874		
HEXAGON 180 LX	180	1998 → 1999				FDB677			P/EF		FSB954		
SUPER HEXAGON 180 GTX	180	2000 →				FDB677			P/EF		FDB2057		EF/AG
SUPER HEXAGON 180 GTX	180	2001 → 2003				FDB2142			ST/SM/EF/AG		FDB2115		P/EF
VESPA 180 SS	180	→				FSB869					FSB874		
X9 180 AMALFI	180	2001 → 2003				FDB2074	2		ST/SM/P/EF/CPRO/AG		FDB2074		ST/SM/P/EF/CPRO/AG
BEVERLY 200 (Grimeca caliper)	200	2001 →				FDB677			P/EF		FDB677		P/EF
BEVERLY B 200 (Heng Tong caliper)	200	2002 → 2006				FDB2142			ST/SM/EF/AG		FDB2142		ST/SM/EF/AG
Carnaby 200	200	2007 → 2009				FDB2142			ST/SM/EF/AG		FDB2142		ST/SM/EF/AG
COSA 200	200	1989 →				FSB893					FSB892		
COSA 2 200	200	1992 →				FSB893					FSB892		
Liberty S 200	200	2007 → 2008				FDB2057			EF/AG		FSB954		
VESPA 200 RALLY	200	→				FSB869					FSB874		
VESPA 200 PX E	200	1978 →				FSB874					FSB874		
VESPA 200 PE	200	1983 →				FSB874					FSB874		
VESPA 200 PX ARCOBALENO	200	1983 →				FSB874					FSB874		
VESPA 200 PX	200	1998 →				FDB2100			EF		FSB874		
VESPA GRANTURISMO 200 (Grimeca caliper)	200	2003 →				FDB677			P/EF		FDB2115		P/EF
VESPA GRANTURISMO 200 (Heng Tong caliper)	200	2003 →				FDB2142			ST/SM/EF/AG		FDB2115		P/EF
X9 200	200	2002 → 2003				FDB2074	2		ST/SM/P/EF/CPRO/AG		FDB2074		ST/SM/P/EF/CPRO/AG
X8 200	200	2004 →				FDB2142			ST/SM/EF/AG		FDB2074		ST/SM/P/EF/CPRO/AG
BEVERLY 250 (Grimeca caliper)	250	2002 → 2006				FDB677			P/EF		FDB677		P/EF
BEVERLY 250 i.e.	250	2006 → 2008				FDB2142			ST/SM/EF/AG		FDB2142		ST/SM/EF/AG
Beverly Sport 250 i.e.	250	2006 → 2008				FDB2142			ST/SM/EF/AG		FDB2142		ST/SM/EF/AG
Beverly Cruiser 250 i.e.	250	2007 → 2009				FDB2142			ST/SM/EF/AG		FDB2142		ST/SM/EF/AG
BEVERLY Tourer 250 i.e.	250	2007 → 2009				FDB2142			ST/SM/EF/AG		FDB2142		ST/SM/EF/AG
Carnaby 250 ie	250	2008 → 2009				FDB2142			ST/SM/EF/AG		FDB2142		ST/SM/EF/AG
HEXAGON 250	250	1998 → 1999				FDB677			P/EF		FSB762		
MP3 250	250	2007 →				FDB2057	2		EF/AG		FDB2207		EF
SUPER HEXAGON 250 GTX	250	2001 → 2002				FDB677			P/EF		FDB2115		P/EF
VESPA GTS - GTV 250 ie	250	2008 →				FDB2142			ST/SM/EF/AG		FDB2115		P/EF
X9 250	250	2000 → 2003				FDB2074	2		ST/SM/P/EF/CPRO/AG		FDB2074		ST/SM/P/EF/CPRO/AG
X9 250 Evolution	250	2005 →				FDB2142		left	ST/SM/EF/AG				
X9 250 Evolution	250	2005 →				FDB2186		right	SM/EF/AG				
X9 250 Evolution	250	2005 →									FDB2207		EF
X8 250	250	2006 →				FDB2142			ST/SM/EF/AG		FDB2207		EF
X8 250 ie	250	2007 →				FDB2142			ST/SM/EF/AG		FDB2207		EF
X7 250	250	2008 →				FDB2186			SM/EF/AG		FDB2186		SM/EF/AG
X-EVO 250 ie	250	2008 →				FDB2142			ST/SM/EF/AG		FDB2186		SM/EF/AG
GTV Via Montenaepoleone 280	280	2010 →				FDB2142			ST/SM/EF/AG		FDB2115		P/EF
Beverly 300 i.e. Tourer (M28)	300	16 2009 → 2010				FDB2142			ST/SM/EF/AG		FDB2142		ST/SM/EF/AG
Beverly 300 i.e. RST (M69)	300	16 2010 →				FDB2142			ST/SM/EF/AG		FDB2186		SM/EF/AG

* It is recommended that in those applications where sintered pads are supplied as Original Equipment, replacement pads should also be of sintered composition.

** To avoid brake imbalance sintered pads fitted in rear calipers should only be used in combination with front calipers containing sintered pads.



CC KW FROM -> TO N° SET L/R COMPOUND N° SET L/R COMPOUND

...PIAGGIO

Beverly 300 by Police	300	2016	→	FDB2142				ST/SM/EF/AG	FDB2186			SM/EF/AG
CARNABY CRUISER 300 ie	300	2008	→	FDB2142				ST/SM/EF/AG	FDB2142			ST/SM/EF/AG
Carnaby 300 ie	300	2012	→	FDB2142				ST/SM/EF/AG	FDB2142			ST/SM/EF/AG
MP3 Hybrid 300 ie 4T 4V	300	2010	→ 2013	FDB2057	2			EF/AG	FDB2186			SM/EF/AG
MP3 Hybrid LT 300 ie 4T 4V	300	2010	→ 2011	FDB2057	2			EF/AG	FDB2186			SM/EF/AG
MP3 LT 300 ie	300	2010	→ 2011	FDB2057	2			EF/AG	FDB2186			SM/EF/AG
MP3 MIC 300 ie	300	2010	→ 2011	FDB2057	2			EF/AG	FDB2186			SM/EF/AG
MP3 300 ie LT Sport	300	2011	→ 2013	FDB2057	2			EF/AG	FDB2186			SM/EF/AG
MP3 Touring 300 ie	300	2011	→ 2012	FDB2057	2			EF/AG	FDB2186			SM/EF/AG
MP3 Touring LT 300 ie	300	2011	→ 2012	FDB2057	2			EF/AG	FDB2186			SM/EF/AG
MP3 300 ie LT Business ABS	300	2014	→	FDB2277	2			AG	FDB2186			SM/EF/AG
MP3 300 ie LT Sport ABS	300	2014	→	FDB2277	2			AG	FDB2186			SM/EF/AG
VESPA GTS 300 Super	300	2008	→	FDB2142				ST/SM/EF/AG	FDB2115			P/EF
VESPA GTS 300 i.e. Supersport	300	2010	→ 2013	FDB2142				ST/SM/EF/AG	FDB2115			P/EF
VESPA GTS 300 i.e. Touring	300	2011	→ 2012	FDB2142				ST/SM/EF/AG	FDB2115			P/EF
VESPA GTS 300 i.e.	300	2012	→	FDB2142				ST/SM/EF/AG	FDB2115			P/EF
VESPA 300 GTS i.e. ABS E4	300	2016	→ 2017	FDB2142				ST/SM/EF/AG	FDB2115			P/EF
Vespa Sei giorni HPE ABS II ed.	300	2020	→	FDB497				ST/SM/SG/P/EF	FDB2115			P/EF
X7 EVO 300	300	2010	→	FDB2142				ST/SM/EF/AG	FDB2186			SM/EF/AG
300 ie MP3 Yourban	300	2011	→ 2012	FDB2057	2			EF/AG	FDB2186			SM/EF/AG
300 ie MP3 Yourban LT	300	2011	→	FDB2057	2			EF/AG	FDB2186			SM/EF/AG
300 ie MP3 Yourban LT Sport	300	2015	→	FDB2057	2			EF/AG	FDB2186			SM/EF/AG
MP3 350	330	2018	→	FDB2277	2			AG				
Beverly 350 (4T 4V)(M69) ABS	350	25	2011	→	FDB2142			ST/SM/EF/AG	FDB2186			SM/EF/AG
Beverly 350 (4T 4V)(M69) No ABS	350	25	2011	→	FDB2105			EF/AG	FDB2186			SM/EF/AG
Beverly 350 i.e. Sport Touring	350	25	2014	→	FDB2142			ST/SM/EF/AG	FDB2186			SM/EF/AG
Beverly 350 Tourer	350	2020	→	FDB2142				ST/SM/EF/AG	FDB2186			SM/EF/AG
X10 350 i.e. (4T 4V)	350	2012	→	FDB2142			left	ST/SM/EF/AG				
X10 350 i.e. (4T 4V)	350	2012	→	FDB2186			right	SM/EF/AG				
X10 350 i.e. (4T 4V)	350	2012	→						FDB2186			SM/EF/AG
X10 EXECUTIVE (ABS-ASR) 350 i.e. (4T 4V)	350	2013	→	FDB2142			left	ST/SM/EF/AG				
X10 EXECUTIVE (ABS-ASR) 350 i.e. (4T 4V)	350	2013	→	FDB2186			right	SM/EF/AG				
X10 EXECUTIVE (ABS-ASR) 350 i.e. (4T 4V)	350	2013	→						FDB2186			SM/EF/AG
Beverly 400 i.e.	400	2007	→ 2007	FDB2018	2			ZR/ST/SG/P/EF	FDB2142			ST/SM/EF/AG
BEVERLY Tourer 400 i.e.	400	2008	→ 2010	FDB2074	2			ST/SM/P/EF/CPRO/AG	FDB2074			ST/SM/P/EF/CPRO/AG
MP3 400 ie	400	2007	→ 2008	FDB2057	2			EF/AG	FDB2142			ST/SM/EF/AG
MP3 LT 400 ie	400	2009	→	FDB2057	2			EF/AG	FDB2207			EF
X-EVO 400 ie	400	2008	→	FDB2142			left	ST/SM/EF/AG				
X-EVO 400 ie	400	2008	→	FDB2186			right	SM/EF/AG				
X-EVO 400 ie	400	2008	→						FDB2186			SM/EF/AG
BEVERLY 500	500	2002	→ 2005	FDB2074	2			ST/SM/P/EF/CPRO/AG	FDB2074			ST/SM/P/EF/CPRO/AG
BEVERLY 500	500	2006	→ 2006	FDB2074	2			ST/SM/P/EF/CPRO/AG	FDB2207			EF
BEVERLY CRUISER 500 ie	500	2007	→ 2012	FDB2074	2			ST/SM/P/EF/CPRO/AG	FDB2074			ST/SM/P/EF/CPRO/AG
M 500 Minicar	500	2006	→ 2008	FDB2153				P				
MP3 500 i.e. Bussines	500	2011	→ 2012	FDB2057	2			EF/AG	FDB2186			SM/EF/AG
MP3 500 i.e. LT Bussines	500	2011	→ 2013	FDB2057	2			EF/AG	FDB2186			SM/EF/AG
MP3 500 i.e. LT Sport	500	2011	→ 2013	FDB2057	2			EF/AG	FDB2186			SM/EF/AG
MP3 500 i.e. Sport	500	2012	→ 2012	FDB2057	2			EF/AG	FDB2186			SM/EF/AG
MP3 500 i.e. LT Business ABS/ASR	500	2014	→	FDB2277	2			AG	FDB2142			ST/SM/EF/AG
MP3 500 i.e. Sport ABS/ASR	500	2014	→	FDB2277	2			AG	FDB2142			ST/SM/EF/AG
MP3 500 Business HPE	500	41	2018	→	FDB2277	2		AG	FDB2142			ST/SM/EF/AG
MP3 500 Sport HPE	500	41	2018	→	FDB2277	2		AG	FDB2142			ST/SM/EF/AG
PK 500 Motocarro	500	2006	→ 2008	FDB2153				P				
X9 500	500	2001	→ 2002	FDB2074	2			ST/SM/P/EF/CPRO/AG	FDB2074			ST/SM/P/EF/CPRO/AG
X9 500	500	2003	→	FDB2018	2			ZR/ST/SG/P/EF	FDB2074			ST/SM/P/EF/CPRO/AG
X9 500 ie	500	2007	→	FDB2018	2			ZR/ST/SG/P/EF	FDB2074			ST/SM/P/EF/CPRO/AG
X10 500 i.e. (4T 4V)	500	2012	→	FDB2142			left	ST/SM/EF/AG				
X10 500 i.e. (4T 4V)	500	2012	→	FDB2186			right	SM/EF/AG				
X10 500 i.e. (4T 4V)	500	2012	→						FDB2186			SM/EF/AG
X10 EXECUTIVE (ABS-ASR) 500 i.e. (4T 4V)	500	2013	→	FDB2142			left	ST/SM/EF/AG				
X10 EXECUTIVE (ABS-ASR) 500 i.e. (4T 4V)	500	2013	→	FDB2186			right	SM/EF/AG				
X10 EXECUTIVE (ABS-ASR) 500 i.e. (4T 4V)	500	2013	→						FDB2186			SM/EF/AG

PIAGGIO (motocarri)

APE 50 P	50	1980	→ 1985	FSB890					FSB886			
APE 50 TM P	50	1985	→ 1989	FSB890					FSB886			
APE 50 FL/FL2	50	1989	→ 1995	FSB890					FSB886			
APE 50 FL3 EUROPA	50	1996	→ 1999	FSB890					FSB886			
APE 50 RST MIX	50	1999	→ 2005	FSB890					FSB886			
APE 50 EURO 2	50	2003	→ 2010	FSB890					FSB886			
APE 150 C 1/2/3	150		→	FSB890								
APE 150 C4	150		→	FSB890								

* It is recommended that in those applications where sintered pads are supplied as Original Equipment, replacement pads should also be of sintered composition.

** To avoid brake imbalance sintered pads fitted in rear calipers should only be used in combination with front calipers containing sintered pads.

1080



CC KW FROM -> TO N° SET L/R COMPOUND N° SET L/R COMPOUND

...PIAGGIO (motocarri)

APE 175 PENTARO'	175		→	FSB890							
APE CAR 220 P2/P3	220	1978	→ 1985	FSB878					FSB878		
APE MP 220 P 501 (II SERIE)	220	1978	→ 1996	FSB878					FSB878		
APE MP 220 P 601 (II SERIE)	220	1978	→ 1996	FSB878					FSB878		
APE TM 220 P 602	220	1982	→ 1983	FSB872					FSB872		
APE TM 220 P 703 / P 703 V / FL2	220	1984	→ 2002	FSB872					FSB872		
APE TM 220	220	2009	→ 2010	FSB872					FSB872		
APE CAR 420 DIESEL	420	1986	→ 1996	FSB878					FSB878		
APE CAR 420 MAX DIESEL 9 q.li	420	1986	→ 1996	FSB878					FSB878		
APE TM 420 P703 / P703 V DIESEL	420	1987	→ 2004	FSB872					FSB872		
APE POKER 420 BENZINA	420	1993	→	FSB982					FSB983		
APE POKER 420 DIESEL	420	1993	→ 1997	FSB982					FSB983		
APE TM 420 DIESEL LCS	420	2005	→ 2010	FSB872					FSB872		
APE MP 420 601 CLASSIC	420	2006	→ 2007	FSB872					FSB872		
Quargo 500	500	2005	→ 2015	FVR549							
VTL 500 QUARGO	500	2005	→						FSB983		
QUARGO 750 DIESEL	750	2004	→ 2006	FSB982					FSB983		
PORTER Box 1.0	993	33	1993 → 1998	FVR549					FSB4016		
PORTER Platform/Chassis 1.0	993	33	1993 → 1994	FVR549					FSB4016		
PORTER Box 1.0	993	35	1994 → 2017	FVR549					FSB4016		
PORTER Platform/Chassis 1.0	993	35	1994 →	FVR549					FSB4016		
PORTER Box 1.2 D	1221	26	1995 →	FVR549					FSB4016		
PORTER Platform/Chassis 1.2 D	1221	26	1995 →	FVR549					FSB4016		
PORTER Box 1.3 i 16V	1295	48	1998 →	FVR549					FSB4016		
PORTER Box 1.3 i 16V 4x4	1295	48	1998 →	FVR549					FSB4016		
PORTER Platform/Chassis 1.3 i 16V	1295	48	1998 →	FVR549					FSB4016		
PORTER Platform/Chassis 1.3 i 16V 4x4	1295	48	1998 →	FVR549					FSB4016		
PORTER Box 1.4 D	1371	28	1998 →	FVR549					FSB4016		
PORTER Platform/Chassis 1.4 D	1371	28	1998 →	FVR549					FSB4016		

PUCH

MAXI 30 30 all models	30		→	FSB712					FSB712		
MAXI 40 40 all models	40		→	FSB712					FSB712		
BORRASCA 50	50		→	FSB826					FSB826		
CONDOR 50	50		→	FDB2107			P		FSB820		
GTL 50	50		→	FDB213			P		FSB712		
MINICROSS 50	50		→	FSB826					FSB826		
MONZA 50 4 GP all models	50		→	FSB712					FSB712		
MONZA 50 4 SL	50		→	FSB712					FSB712		
MONZA 50	50	1983	→	FSB820					FSB820		
MONZA 50	50	1984	→	FDB213			P		FSB827		
MONZA 50 50 (alloy wheels 160x17)	50	1984	→	FSB827					FSB827		
MONZA 50	50	1985	→	FDB2107			P		FSB827		
RADICAL 50	50	1994	→	FSB937					FSB937		
COBRA 75	75	1985	→	FDB2107			P		FSB820		
LIDO 75 (scooter)	75	1986	→	FSB777					FSB777		
80 /6	80		→	FDB213			P		FSB712		
COBRA 80	80	1984	→	FDB2107			P		FSB820		
GS 80 V	80	1983	→	FSB898					FSB898		
MAXI 80	80	1988	→	FDB696			AG		FDB207		ST/P/EF/CP1
MAXI 80 EXECUTIVE	80	1988	→	FSB908					FSB877		
125	125	1987	→	FDB438			P/EF				
FS 125 REGOLARITA'	125	1983	→	FSB898					FSB898		
CROSS 250	250	1986	→ 1986	FDB207			ST/P/EF/CP1		FDB694		ST/AG
F5 250 REGOLARITA'	250	1983	→	FSB901					FSB876		
F5 250	250	1984	→	FSB898							
HFE 250	250	1986	→ 1986	FDB207			ST/P/EF/CP1		FSB876		
MC 250 VHS W	250	1983	→	FSB901					FSB876		
CROSS 347	347		→ 1981	FSB901					FSB852		
FS 347 REGOLARITA'	347		→ 1983	FSB901					FSB876		
348	348		→	FDB213			P				
MC 496	496		→ 1983	FSB901					FSB876		
504	504		→	FDB213			P				
506	506		→	FDB213			P				
560 (Rotax engine)	560		→	FDB213			P				
ENDURO 600 4 VALVES	600	1985	→	FDB207			ST/P/EF/CP1		FDB207		ST/P/EF/CP1

* It is recommended that in those applications where sintered pads are supplied as Original Equipment, replacement pads should also be of sintered composition.

** To avoid brake imbalance sintered pads fitted in rear calipers should only be used in combination with front calipers containing sintered pads.



CC KW FROM -> TO N° SET L/R COMPOUND N° SET L/R COMPOUND

QUADRO

350 D	350	2011 → 2015	FDB680	2		ST/EF	FDB313			SG/P/EF
350 S	350	2013 → 2015	FDB680	2		ST/EF	FDB313			SG/P/EF
350 4	350	2014 → 2015	FDB680	2		ST/EF	FDB313	2		SG/P/EF

RAPIDO

SCRENNIA 50	50	→	FSB914				FSB731			
-------------	----	---	--------	--	--	--	--------	--	--	--

REAL

NEVADA 80 SPORT	80	→	FDB213			P				
-----------------	----	---	--------	--	--	---	--	--	--	--

RIEJU

MRT 50	50	2008 →	FDB384			P	FDB384			P
MRT 50 PRO / SUPERMOTARD / Competizione	50	2008 →	FDB2074			ST/SM/P/EF/CPRO/AG	FDB384			P
MRT 50 SUPERMOTARD	50	2010 →	FDB384			P	FDB384			P
MRX 50 CASTROL	50	2001 → 2002	FDB706			P	FRP405			ST/SG/PRP/P/EF
MRX 50	50	2003 → 2008	FRP405			ST/SG/PRP/P/EF	FRP405			ST/SG/PRP/P/EF
MRX 50 PRO / TOP	50	2004 → 2008	FDB677			P/EF	FRP405			ST/SG/PRP/P/EF
MTR 50 Competizione (Spoke Wheel)	50	2011 →	FDB2242			P/EF	FDB2162			SG/P/EF
NKD 50	50	2007 →	FDB2147			AG	FRP405			ST/SG/PRP/P/EF
RR 50 THUNDERFIRE	50	1997 → 2002	FRP405			ST/SG/PRP/P/EF	FRP405			ST/SG/PRP/P/EF
RR 50 CASTROL	50	2000 → 2002	FDB706			P	FRP405			ST/SG/PRP/P/EF
RR 50 SPORT	50	2003 → 2006	FRP405			ST/SG/PRP/P/EF	FRP405			ST/SG/PRP/P/EF
RS1 50	50	1997 → 2000	FRP405			ST/SG/PRP/P/EF	FRP405			ST/SG/PRP/P/EF
RS1 50	50	2001 → 2004	FDB706			P	FRP405			ST/SG/PRP/P/EF
RS2 MATRIX 50 (AJP)	50	2002 → 2008	FDB2147			AG	FRP405			ST/SG/PRP/P/EF
RS2 NKD	50	2005 →	FDB677			P/EF	FRP405			ST/SG/PRP/P/EF
RS2 50 PRO (AJP)	50	2006 → 2008	FRP405			ST/SG/PRP/P/EF	FRP405			ST/SG/PRP/P/EF
RS2 50 MATRIX / PRO 50 (JJUAN)	50	2007 → 2008	FDB2169			P/EF	FDB384			P
RS2 50 FR / PRO	50	2008 →	FDB2169			P/EF	FDB828			ST/P
RS2 50	50	2009 →	FDB2147			AG	FRP405			ST/SG/PRP/P/EF
RS2 50 PRO	50	2009 →	FDB2169			P/EF	FDB828			ST/P
SMX 50	50	2002 →	FRP405			ST/SG/PRP/P/EF	FRP405			ST/SG/PRP/P/EF
SMX 50 PRO	50	2004 →	FDB677			P/EF	FRP405			ST/SG/PRP/P/EF
SPIKE 50	50	2004 →	FRP405			ST/SG/PRP/P/EF	FRP405			ST/SG/PRP/P/EF
SPIKE 50 MOTARD	50	2004 →	FDB706			P	FRP405			ST/SG/PRP/P/EF
TANGO 50 / TANGOO! 50	50	2007 →	FDB2074			ST/SM/P/EF/CPRO/AG	FRP405			ST/SG/PRP/P/EF
TANGO 50 Motard	50	2009 →	FDB384			P	FRP405			ST/SG/PRP/P/EF
TANGO 50	50	2013 → 2015	FDB2242			P/EF	FDB2128			EF
MR 80	80	→	FDB2107			P	FSB827			
MARATHON 125 / MOTARD	125	2008 →	FDB384			P	FDB384			P
MARATHON 125 PRO / SUPERMOTARD	125	2008 →	FDB2074			ST/SM/P/EF/CPRO/AG	FDB384			P
Marathon Pro 125 Competizione (Spoke Wheel)	125	2011 →	FDB2242			P/EF	FDB2162			SG/P/EF
MRX 125	125	2002 → 2008	FDB706			P	FRP405			ST/SG/PRP/P/EF
NKD 125	125	2006 → 2007	FDB2147			AG	FRP405			ST/SG/PRP/P/EF
NKD 125	125	2008 →	FDB2169			P/EF	FDB828			ST/P
RS2 125 (AJP)	125	2006 → 2008	FDB2147			AG	FRP405			ST/SG/PRP/P/EF
RS2 125 / PRO 125 (JJUAN)	125	2007 → 2008	FDB2169			P/EF	FDB384			P
RS2 125 / PRO	125	2009 →	FDB677			P/EF	FRP405			ST/SG/PRP/P/EF
RS3 125	125	2009 →	FDB2074			ST/SM/P/EF/CPRO/AG	FRP405			ST/SG/PRP/P/EF
SMX 125	125	2002 → 2007	FDB706			P	FRP405			ST/SG/PRP/P/EF
SMX 125 / Street	125	2007 →	FDB2074			ST/SM/P/EF/CPRO/AG	FRP405			ST/SG/PRP/P/EF
TANGO 125 / PRO	125	2006 → 2010	FDB2074			ST/SM/P/EF/CPRO/AG	FRP405			ST/SG/PRP/P/EF
TANGO 125	125	2011 →	FDB2242			P/EF	FDB2128			EF
MARATHON 250	250	2010 →	FDB2018			ZR/ST/SG/P/EF	FDB2165			SG/P/EF
TANGO 250	250	2008 → 2011	FDB2074			ST/SM/P/EF/CPRO/AG	FRP405			ST/SG/PRP/P/EF
TANGO 250	250	2012 → 2013	FDB2242			P/EF	FDB2128			EF
MARATHON 450	450	2010 →	FDB2018			ZR/ST/SG/P/EF	FDB2165			SG/P/EF
MARATHON 450 Motard	450	2010 →	FRP416	2		P	FDB2165			SG/P/EF

RIXE

RS 80 W	80	→	FDB213	2		P				
---------	----	---	--------	---	--	---	--	--	--	--

* It is recommended that in those applications where sintered pads are supplied as Original Equipment, replacement pads should also be of sintered composition.

** To avoid brake imbalance sintered pads fitted in rear calipers should only be used in combination with front calipers containing sintered pads.



CC KW FROM -> TO



N° SET L/R COMPOUND



N° SET L/R COMPOUND

RIZZATO

ATALA CALIFFONE 50 (alloy wheels)	50		→	FSB907				FSB907			
ATALA CALIFFONE 50 (spoke wheels)	50		→	FSB910				FSB910			
ATALA MASTER 50 (alloy wheels)	50		→	FSB907				FSB907			
ATALA UNO 50 (spoke wheels)	50		→	FSB902				FSB902			
ATALA HACKER 50	50	1995	→	FDB680			ST/EF	FSB777			
ATALA CAROSELLO 50	50	1997	→	FDB697			EF				

ROYAL ENFIELD

Bullet 350	346	14	2009	→	FDB497			ST/SM/SG/P/EF	FSB978		
Bullet 350 Twinspark	346	15	2013	→	FSB978				FSB978		
Classic 350	346	15	2013	→	FSB978				FSB978		
Thunderbird 350	346	15	2014	→	FDB497			ST/SM/SG/P/EF	FDB2005		ST/SG/P/EF
Bullet 350	350		2010	→	FSB978				FSB978		
Thunderbird	350		2012	→	FDB497			ST/SM/SG/P/EF	FDB2005		ST/SG/P/EF
BulletElectra X (All disc models/Dual Seat)	500		2005	→ 2014	FDB497			ST/SM/SG/P/EF			
Bullet500 (Efi / Dual Seat)	500		2009	→ 2014	FDB497			ST/SM/SG/P/EF			
BulletBattle Green 500 (Efi / Single Seat)	500		2009	→ 2014	FDB497			ST/SM/SG/P/EF			
BulletClassic 500 (Efi / Single Seat)	500		2009	→ 2014	FDB497			ST/SM/SG/P/EF			
BulletClassic Chrome 500 (Efi / Single Seat)	500		2009	→ 2014	FDB497			ST/SM/SG/P/EF			
BulletDesert Storm 500 (Efi / Single Seat)	500		2012	→ 2014	FDB497			ST/SM/SG/P/EF			
Clubman500 EFI	500		2009	→ 2012	FDB497			ST/SM/SG/P/EF			
Electra500 EFI	500		2009	→ 2014	FDB497			ST/SM/SG/P/EF			
Fury500 (Efi)	500		2011	→ 2012	FDB497			ST/SM/SG/P/EF			
Trials500 EFI	500		2009	→ 2012	FDB497			ST/SM/SG/P/EF			
Woodsman500 EFI	500		2009	→ 2012	FDB497			ST/SM/SG/P/EF			
Continental GT	535		2014	→	FDB2006			ST/P/EF	FDB2005		ST/SG/P/EF

SACHS

ROADSTER 125	125		2000	→ 2003	FDB706			P	FSB733		
XTC 125 SUPERSPORT	125		2000	→	FDB498			XRAC/ST/P	FDB828		ST/P
ZX 125	125		2001	→	FDB677			P/EF	FDB828		ST/P
ROADSTER 650	650		2001	→	FDB498			XRAC/ST/P	FDB383		SG/P/EF
ROADSTER 800	800		2001	→	FDB498	2		XRAC/ST/P	FSB784		

SCORPA

SR 125 (2T)	125		2010	→ 2013	FDB2109			P	FDB2127		SG
SR 125 Long Ride (2T)	125		2010	→ 2011	FDB2109			P	FDB2127		SG
SY 125 (4T) Long Ride	125		2009	→ 2010	FDB2109			P	FDB2127		SG
T-Ride 125 F (Enduro)	125		2010	→	FDB2242			P/EF	FDB2128		EF
TY 125 (4T)	125		2011	→ 2013	FDB2109			P	FDB2127		SG
SY 200 F (4T) (163cc)	200		2008	→ 2008	FDB2109			P	FDB2127		SG
SY 250 F (4T) Long Ride	250		2007	→ 2008	FDB2109			P	FDB2127		SG
SY 250 FR (4T) Long Ride	250		2010	→ 2010	FDB2109			P	FDB2127		SG
T-Ride 250 F (Enduro)	250		2008	→ 2011	FDB2242			P/EF	FDB2128		EF
SR 280 (2T)	280		2009	→	FDB2109			P	FDB2127		SG
SR 280 (2T) Long Ride	280		2009	→ 2011	FDB2109			P	FDB2127		SG
Raidster 660	660		2007	→	FDB2042			ZRAC/XRAC/ST/P/EF/ICPRO	FDB2127		SG

SHERCO

Enduro 50cc (2T)	50		2002	→ 2007	FDB706			P	FDB2107		P
Enduro 50c (2T)/Urban/SU - Spoke wheel models)	50		2008	→ 2013	FDB677			P/EF	FDB2128		EF
50 SE-R	50		2014	→	FDB313			SG/P/EF	FDB313		SG/P/EF
SM 0.5cc Black Panther	50		2008	→ 2010	FDB677			P/EF	FDB2128		EF
50 SM-R	50		2014	→	FDB313			SG/P/EF	FDB313		SG/P/EF
SU 50 (2T) Urban Base - Cast wheel model)	50		2010	→	FDB384			P	FDB2128		EF
Supermotard 50cc (2T)	50		2002	→ 2007	FDB706			P	FDB2107		P
Supermotard 50cc (2T)	50		2008	→ 2013	FDB677			P/EF	FDB2128		EF
ST80 (2T)	80		2013	→ 2014	FDB2262			SG	FDB2127		SG
Trials 0.8 (2T)	80		2001	→ 2004	FDB2107			P	FDB2127		SG
Trials 0.8 (2T) AJP CALIPER	80		2005	→ 2010	FDB2109			P	FDB2127		SG
City Corp 125 (All models)	125		2003	→ 2007	FDB706			P	FDB2107		P
City Corp 125 (All models)	125		2008	→	FDB677			P/EF	FDB2128		EF
SE 1.25 F Enduro (4T)	125		2010	→ 2012	FDB677			P/EF	FDB2128		EF
SE-R 125	125		2017	→	FDB2018			ZR/ST/SG/P/EF	FDB2165		SG/P/EF
SM 1.25 i F Black Panther (4T)	125		2010	→ 2012	FDB677			P/EF	FDB2128		EF
ST125 (2T)	125		2013	→ 2014	FDB2262			SG	FDB2127		SG
ST125 (2T) AJP CALIPER	125		2015	→	FDB2109			P	FDB2127		SG

* It is recommended that in those applications where sintered pads are supplied as Original Equipment, replacement pads should also be of sintered composition.

** To avoid brake imbalance sintered pads fitted in rear calipers should only be used in combination with front calipers containing sintered pads.



CC KW FROM -> TO N° SET L/R COMPOUND N° SET L/R COMPOUND

...SHERCO

Trials 1.25cc (2T)	125	1999	→ 2005	FDB2107			P	FDB2107		P
Trials 1.25cc (2T) AJP CALIPER	125	2006	→ 2011	FDB2109			P	FDB2127		SG
X-Ride125	125	2012	→	FDB313			SG/P/EF	FDB313		SG/P/EF
XY	125	2014	→	FDB2109			P	FDB2127		SG
Trials 2.0cc (2T)	200	1999	→ 2005	FDB2107			P	FDB2107		P
Enduro 2.5i (4T) Inc. SE Models	250	2008	→ 2011	FDB2018			ZR/ST/SG/P/EF	FDB2162		SG/P/EF
SE-R 250 (2T)	250	2012	→	FDB2018			ZR/ST/SG/P/EF	FDB2165		SG/P/EF
SE250 i (2T/Brembo Rear Caliper)	250	2012	→	FDB2018			ZR/ST/SG/P/EF	FDB2165		SG/P/EF
SEF 250 (4T)	250	2013	→	FDB2018			ZR/ST/SG/P/EF	FDB2165		SG/P/EF
SEF-R 250 (4T)	250	2013	→	FDB2018			ZR/ST/SG/P/EF	FDB2165		SG/P/EF
SM 2.5i Supermotard (4T)	250	2008	→	FDB2018			ZR/ST/SG/P/EF	FDB2162		SG/P/EF
ST250 (2T)	250	2013	→ 2014	FDB2262			SG	FDB2127		SG
ST250 (2T) AJP CALIPER	250	2015	→	FDB2109			P	FDB2127		SG
SX 2.5i F Moto Cross	250	2010	→	FDB2018			ZR/ST/SG/P/EF	FDB2162		SG/P/EF
Trials 2.5 (2T)	250	1999	→ 2005	FDB2107			P	FDB2107		P
Trials 2.5 (2T) AJP CALIPER	250	2006	→ 2011	FDB2109			P	FDB2127		SG
ST290 (2T)	290	2013	→ 2014	FDB2262			SG	FDB2127		SG
Trials 2.9 (2T)	290	1999	→ 2005	FDB2107			P	FDB2107		P
Trials 2.9 (2T) AJP CALIPER	290	2006	→ 2011	FDB2109			P	FDB2127		SG
X-Ride 290	290	2012	→	FDB313			SG/P/EF	FDB313		SG/P/EF
Enduro SE 3.0i (4T)	300	2010	→ 2011	FDB2018			ZR/ST/SG/P/EF	FDB2162		SG/P/EF
SE-R 300 (2T)	300	2012	→	FDB2018			ZR/ST/SG/P/EF	FDB2165		SG/P/EF
SE300 i (2T/Brembo Rear Caliper)	300	2012	→	FDB2018			ZR/ST/SG/P/EF	FDB2165		SG/P/EF
SEF 300 (4T)	300	2013	→	FDB2018			ZR/ST/SG/P/EF	FDB2165		SG/P/EF
SEF-R 300 (4T)	300	2013	→	FDB2018			ZR/ST/SG/P/EF	FDB2165		SG/P/EF
ST300 (2T)	300	2013	→ 2014	FDB2262			SG	FDB2127		SG
ST300 (2T) AJP CALIPER	300	2015	→	FDB2109			P	FDB2127		SG
Trials 3.2cc (4T) AJP CALIPER	320	2005	→ 2011	FDB2109			P	FDB2127		SG
Enduro 4.5i (4T) Inc SE Models	450	2004	→ 2011	FDB2018			ZR/ST/SG/P/EF	FDB2162		SG/P/EF
SE 450 i R (Nissin Rear Caliper)	450	2012	→ 2013	FDB2018			ZR/ST/SG/P/EF	FDB2162		SG/P/EF
SEF-R 450	450	2015	→	FDB2018			ZR/ST/SG/P/EF	FDB2165		SG/P/EF
SM 4.5i F (Supermotard)	450	2004	→ 2010	FDB2018			ZR/ST/SG/P/EF	FDB2162		SG/P/EF
SM 4.5i F (Black Panther)	450	2008	→ 2012	FDB2120			ZRAC/XRAC/ST	FDB2162		SG/P/EF
Enduro 5.1iF Inc SE Models	510	2007	→ 2011	FDB2018			ZR/ST/SG/P/EF	FDB2162		SG/P/EF
SE 510 i R (Nissin Rear Caliper)	510	2012	→ 2013	FDB2018			ZR/ST/SG/P/EF	FDB2162		SG/P/EF
SM 5.1i F Supermotard	510	2007	→	FDB2018			ZR/ST/SG/P/EF	FDB2162		SG/P/EF
SM 5.1i F Black Panther	510	2008	→ 2012	FDB2120			ZRAC/XRAC/ST	FDB2162		SG/P/EF

SIMSON

SR 50 XC/XCE	50		→	FRP405			ST/SG/PRP/P/EF			
SR 50 /1 GAMMA	50	1994	→	FRP405			ST/SG/PRP/P/EF			
SR 50 GAMMA E	50	1994	→	FRP405			ST/SG/PRP/P/EF			
SR 80 XCE	80		→	FRP405			ST/SG/PRP/P/EF			
SR 80 /1 GAMMA	80	1994	→	FRP405			ST/SG/PRP/P/EF			

SINNIS

Nitro 50 (2T)	50	2009	→ 2010	FDB312			ST/P/EF	FSB704		
Pioneer 50 (2T)	50	2009	→ 2010					FSB704		
QM 50 10A (B) Hawk	50	2008	→ 2010	FDB497			ST/SM/SG/P/EF	FSB883		
QM 50 QT-2T Falcon	50	2008	→ 2010	FDB636			P/EF	FSB704		
QM 50 QT-6A Jet 50	50	2008	→ 2010	FDB636			P/EF	FSB704		
QM 50 T-10R Eagle 50	50	2010	→ 2012	FDB497			ST/SM/SG/P/EF	FSB883		
Strike 50 (2T)	50	2009	→ 2010	FDB312			ST/P/EF	FSB704		
Pioneer 125	125	2009	→ 2010					FSB733		
QM 125- 2 D Stealth 125	125	2008	→ 2010	FDB497		left	ST/SM/SG/P/EF			
QM 125- 2 D Stealth 125	125	2008	→ 2010	FDB2087		right	EF			
QM 125- 2 D Stealth 125	125	2008	→ 2010					FDB531		ST/P/EF
QM 125-2 C Vista 125	125	2008	→	FDB384			P	FSB736		
QM 125-2 V Max 125	125	2008	→ 2010	FDB2003			ST/SM/P/EF	FSB733		
QM 125 GY Apache 125 (Rear drum model)	125	2009	→ 2010	FDB497			ST/SM/SG/P/EF	FSB721		
QM 125 GY-2B (A) Apache 125 (Rear disc model)	125	2009	→ 2010	FDB497			ST/SM/SG/P/EF	FDB250		SG/P/EF
QM 125 GY-2B Blade 125	125	2009	→ 2010	FDB497			ST/SM/SG/P/EF	FDB250		SG/P/EF
QM 125 GY-2D Trackstar 125 (4T)	125	2010	→	FDB384			P	FSB721		
QM 125 T- Matrix	125	2010	→	FDB250			SG/P/EF	FSB733		
QM 125 T-10H Matrix II	125	2010	→	FDB250			SG/P/EF	FSB733		
QM 125 T-10R Eagle 125	125	2010	→	FDB250			SG/P/EF	FSB733		
Sublime 125	125	2009	→ 2010					FSB733		
125 T-8G Ecocity 125	125	2007	→ 2009	FDB250			SG/P/EF	FDB2074		ST/SM/P/EF/CPRO/AG
WY 125 T-56A Nitro 125	125	2009	→ 2010	FDB312			ST/P/EF	FSB733		
Grampus 250	250	2010	→	FDB2087			EF	FDB2074		ST/SM/P/EF/CPRO/AG

* It is recommended that in those applications where sintered pads are supplied as Original Equipment, replacement pads should also be of sintered composition.

** To avoid brake imbalance sintered pads fitted in rear calipers should only be used in combination with front calipers containing sintered pads.



	CC	KW	FROM -> TO	N° SET	L/R	COMPOUND	N° SET	L/R	COMPOUND
SUZUKI									
adaptable to 130x28 front and rear drums			→	FSB787			FSB787		
ADDRESS 50 (SPAIN)	50		→	FSB777			FSB777		
ADDRESS 50	50	1990	→ 1991	FSB792			FSB792		
ADDRESS 50	50	1992	→ 1995	FDB313		SG/P/EF	FSB792		
AH 50	50	1993	→ 1995	FSB792			FSB792		
AP 50	50	1971	→ 1978	FSB722			FSB722		
AP 50	50	1995	→ 2002	FDB889		ST/EF	FSB722		
AY 50 KATANA (Brembo caliper)	50	1997	→	FDB680		ST/EF	FSB777		
AY 50 W KATANA	50	1998	→	FRP405		ST/SG/PRP/P/EF	FSB777		
AY 50 WR KATANA	50	1998	→	FRP405		ST/SG/PRP/P/EF	FSB777		
CARNA 50	50	1990	→	FSB727					
CL 50 D LOVE	50	1983	→	FSB727			FSB726		
CL 50 D SUZY	50	1983	→	FSB727			FSB726		
CP 50 CHF	50	1985	→	FSB777			FSB777		
CP 50	50	1991	→ 1993	FSB777			FSB777		
CS 50 D	50	1983	→ 1984	FSB726			FSB726		
CS 50 Z ROADIE	50	1983	→ 1984	FSB726			FSB726		
DR 50 BIG	50	1989	→	FRP405		ST/SG/PRP/P/EF			
F 50 SUZY	50		→	FSB727			FSB727		
F 50	50	1971	→ 1973	FSB722			FSB722		
FR 50	50	1971	→ 1981	FSB722			FSB722		
FS 50 T - X SNIP	50	1981	→ 1982	FSB727			FSB727		
GT 50	50	1977	→ 1980				FSB722		
JR 50	50	1993	→ 2003	FSB775					
LIDO 50	50	1989	→ 1990	FSB777			FSB777		
OR 50	50	1980	→	FDB314		ST/SG/P/EF	FSB723		
RG 50 GAG - GAMMA	50	1987	→	FDB338		ST/P/EF	FSB728		
RM 50 C - N - T	50	1978	→ 1980	FSB722			FSB722		
RM 50 X - Z 50	50	1981	→ 1982	FSB723			FSB723		
RME 50 R	50	2010	→				FDB2139		SG/P/EF
RMX 50	50	2000	→ 2001	FRP405		ST/SG/PRP/P/EF	FRP405		ST/SG/PRP/P/EF
S 50 K	50	1993	→	FSB728					
SEPIA 50	50	1992	→ 1995	FDB313		SG/P/EF	FSB777		
SEPIA AU 50 ZZ	50	1996	→ 1998	FDB313		SG/P/EF	FSB792		
SMX 50 SUPER MOTARD	50	2000	→ 2003	FRP405		ST/SG/PRP/P/EF	FRP405		ST/SG/PRP/P/EF
TR 50 STREET MAGIC	50	1998	→ 2000	FDB2133		SG/EF	FSB883		
TS 50 D all models	50	1979	→	FSB722			FSB722		
TS 50 XKE-XKG all models	50	1984	→ 2000	FSB729			FSB723		
TUNE 50	50	1993	→ 1995	FDB313		SG/P/EF	FSB792		
UF 50 ESTILETE	50	2000	→ 2002	FRP405		ST/SG/PRP/P/EF	FSB777		
UX 50 ZILLION	50	1998	→ 2002	FRP405		ST/SG/PRP/P/EF	FSB777		
ZR 50 KEN - KEX	50	1979	→				FSB722		
ZR 50 SKX - SLKX	50	1981	→ 1987	FDB314		ST/SG/P/EF	FSB723		
ZZ 50	50	1992	→ 1995	FDB313		SG/P/EF	FSB777		
RM 65	65	2003	→	FDB2110		SG	FDB381		SG/P/EF
DR-Z 70	70	2008	→	FSB702			FSB702		
FR 70	70	1974	→	FSB722			FSB722		
LIDO 75	75	1989	→	FDB313		SG/P/EF	FSB777		
3 E 80	80		→	FDB314		ST/SG/P/EF	FSB722		
AH 80	80	1992	→ 1994	FDB313		SG/P/EF	FSB777		
CP 80 CHF	80	1985	→ 1993	FSB777			FSB777		
DS 80	80	1993	→ 2000	FSB723			FSB723		
FR 80 all models	80	1976	→ 1983	FSB722			FSB722		
GT 80 L	80	1981	→	FDB314		ST/SG/P/EF	FSB722		
RG 80 GAMMA	80		→ 1987	FDB314		ST/SG/P/EF	FSB721		
RG 80 GAMMA	80	1988	→ 1993	FDB437		P	FSB721		
RM 80 X - D - E	80		→ 1985	FSB721			FSB723		
RM 80 N - B - C	80	1977	→ 1979	FSB722			FSB722		
RM 80 XT - XX	80	1980	→ 1981	FSB723			FSB723		
RM 80 XD - XE - XF - XZ	80	1981	→ 1985				FSB764		
RM 80 X	80	1986	→ 1989	FDB313		SG/P/EF	FSB764		
RM 80 L/M	80	1990	→ 1994	FDB313		SG/P/EF	FDB313		SG/P/EF
RM 80 XT- XV - X	80	1996	→ 2001	FDB2133		SG/EF	FDB313		SG/P/EF
TS 80 X	80	1984	→	FSB729					
RM 85 L	85	2002	→ 2004	FDB2133		SG/EF	FDB313		SG/P/EF
RM 85 L	85	2005	→	FDB2080		SG	FDB2197		SG
TS 90	90	1971	→ 1973	FSB722			FSB721		
A 100 all models	100	1974	→ 1980	FSB722			FSB722		
ADDRESS 100 V	100	1992	→ 1996	FDB313		SG/P/EF	FSB883		
GP 100 C - DEN - N - X	100	1978	→ 1987	FDB314		ST/SG/P/EF	FSB722		
GP 100 UD - UN - UX	100	1979	→ 1992	FSB721			FSB722		
RM 100 A - B - C	100	1976	→ 1978	FSB722			FSB721		
RM 100 N-T-X	100	1979	→ 1981	FSB722			FSB728		
TS 100 K - L - M	100	1973	→ 1975	FSB722			FSB721		

* It is recommended that in those applications where sintered pads are supplied as Original Equipment, replacement pads should also be of sintered composition.

** To avoid brake imbalance sintered pads fitted in rear calipers should only be used in combination with front calipers containing sintered pads.



CC KW FROM -> TO N° SET L/R COMPOUND N° SET L/R COMPOUND

...SUZUKI

TS 100 A - B - C	100	1975 → 1981	FSB721				FSB721			
TS 100 ERN - ERT - ERX	100	1975 → 1981	FSB721				FSB721			
TS 100 ERZ	100	1982 → 1987	FSB721				FSB723			
ADDRESS 110	110	2015 →	FDB2133			SG/EF	FSB777			
Hayate	110	2012 →	FSB975				FSB975			
UG 110 HOKUTO	110	2000 → 2004	FDB2133			SG/EF	FSB883			
Access	125	2007 →	FSB777				FSB777			
ADDRESS 125	125	2008 →	FDB2087			EF	FSB724			
AN 125	125	1995 → 2000	FDB2133			SG/EF	FSB777			
CS 125 D	125	1983 →	FSB722				FSB722			
DR 125 SD - SZ	125	1982 → 1984	FSB721				FSB721			
DR 125 S	125	1986 → 1993	FDB250			SG/P/EF	FSB721			
DR-Z 125	125	2003 →	FDB2133			SG/EF	FSB721			
DR-Z 125	125	2003 → 2008	FSB721				FSB721			
DR 125 SM	125	2008 →	FDB892			ZR/SG/P/EF/CPRO	FDB2162			SG/P/EF
ER 125	125	→	FSB721				FSB721			
GN 125	125	1983 → 1993	FDB384			P	FSB721			
GN 125 R	125	1994 → 2001	FDB314			ST/SG/P/EF	FSB721			
GP 125 X - XD	125	1977 → 1984					FSB721			
GS 125 D	125	1982 → 1984	FSB721				FSB721			
GS 125 ESZ	125	1982 →	FDB314			ST/SG/P/EF	FSB721			
GS 125 Z	125	1982 → 1984	FSB721				FSB721			
GS 125 ESD	125	1983 → 1994	FDB384			P	FSB721			
GS 125 E - KATANA	125	1990 → 1994	FDB384			P	FSB721			
GS 125 ESR / ESX	125	1995 → 2000	FDB314			ST/SG/P/EF	FSB721			
GSX-R 125 ABS	125	2016 →	FDB2287			EF	FDB2275			P/EF
GSX-S 125 ABS	125	2016 →	FDB2287			EF	FDB2275			P/EF
GT 125 N - EN	125	1974 →					FSB721			
GZ 125 MARAUDER	125	1998 → 2011	FDB404			P	FSB721			
Heat	125	2006 → 2008	FSB973				FSB973			
LIDO 125 VARIO	125	1990 → 1993	FDB313			SG/P/EF	FSB777			
RG 125 E	125	1982 → 1984	FDB314			ST/SG/P/EF	FSB721			
RG 125 W GAMMA	125	1985 → 1991	FDB437			P	FSB721			
RG 125 T - FV	125	1992 → 1996	FDB574			ZRAC/XRAC/ST/P/EF/CP1	FDB607			P
RG 125 U WOLF	125	1992 → 1994	FDB481			ST/P/EF	FDB607			P
RM 125 A - B - C - M	125	1975 → 1978	FSB721				FSB721			
RM 125 N	125	1979 → 1980	FSB721				FSB729			
RM 125 N - T	125	1979 → 1980	FSB721				FSB728			
RM 125 D - X - Z	125	1981 → 1983	FSB721				FSB786			
RM 125 X - Z	125	1981 → 1983	FSB721				FSB786			
RM 125 E	125	1984 → 1984	FSB778				FSB786			
RM 125 F - G	125	1985 → 1986	FDB404			P	FSB786			
RM 125 H	125	1987 →	FDB497			ST/SM/SG/P/EF	FSB786			
RM 125 J	125	1988 →	FDB497			ST/SM/SG/P/EF	FDB661			SG/P
RM 125 K - L - M	125	1989 → 1995	FDB497			ST/SM/SG/P/EF	FDB659			SG/P/EF
RM 125 T - U - V	125	1996 → 1998	FDB892			ZR/SG/P/EF/CPRO	FDB539			SG/P/EF
RM 125 X - Y - K1	125	1999 → 2008	FDB892			ZR/SG/P/EF/CPRO	FDB539			SG/P/EF
RM 125	125	2009 →	FDB892			ZR/SG/P/EF/CPRO	FDB2162			SG/P/EF
RM 125 E	125	2009 →	FDB892			ZR/SG/P/EF/CPRO	FDB2162			SG/P/EF
RV 125 K	125	1973 →	FSB722				FSB721			
RV 125 A - L - M	125	1974 → 1976	FSB721				FSB721			
RV 125 K2/ K3 / K4 VAN VAN	125	2002 →	FDB2049			XRAC/ST/P/EF/CP1	FSB722			
SIXTEEN 125 UH	125	2008 →	FDB2196			ST/SM/P/EF	FDB2148			SG/EF
SM 125	125	2010 →	FDB892			ZR/SG/P/EF/CPRO	FDB2162			SG/P/EF
T 125 STINGER	125	1970 → 1971	FSB721				FSB721			
TS 125 K	125	1972 → 1972	FSB722				FSB721			
TS 125 A - B - C - C2	125	1973 → 1981	FSB721				FSB721			
TS 125 ERN - ERT - ERX	125	1973 → 1981	FSB721				FSB721			
TS 125 L	125	1973 → 1981	FSB721				FSB721			
TS 125 M - N	125	1973 → 1984	FSB721				FSB721			
TS 125 ERZ - FFS	125	1982 → 1983	FSB721				FSB723			
TS 125 L - LC - XE	125	1984 → 1987	FSB721				FSB729			
TS 125 X	125	1988 →	FDB250			SG/P/EF	FSB728			
TS 125 RK	125	1989 →	FDB250			SG/P/EF	FDB659			SG/P/EF
TS 125	125	1990 → 1996	FDB497			ST/SM/SG/P/EF	FDB250			SG/P/EF
TX 125 XF	125	1985 →	FDB250			SG/P/EF	FSB729			
UE - 125 EPICURO	125	1998 → 2000	FDB2133			SG/EF	FSB957			
UE - 125 EPICURO	125	2001 → 2002	FDB2133			SG/EF	FDB2133			SG/EF
UH 125 BURGMAN	125	2007 → 2013	FDB2196			ST/SM/P/EF	FDB2148			SG/EF
UH 125 BURGMAN ABS	125	2014 →	FDB631			ST/SM/SG/P/EF/AG	FDB2148			SG/EF
VAN VAN 125 (RV)	125	2010 →	FDB2049			XRAC/ST/P/EF/CP1	FSB722			
VL 125 INTRUDER	125	2000 →	FDB404			P	FSB721			
X4 125	125	→	FDB314			ST/SG/P/EF	FSB721			
Zeus	125	2006 → 2010	FSB973				FSB973			

* It is recommended that in those applications where sintered pads are supplied as Original Equipment, replacement pads should also be of sintered composition.

** To avoid brake imbalance sintered pads fitted in rear calipers should only be used in combination with front calipers containing sintered pads.



	CC	KW	FROM -> TO		N° SET	L/R	COMPOUND		N° SET	L/R	COMPOUND	
...SUZUKI												
AN 150	150		1997 → 2000	FDB404			P		FSB777			
GSX-R 150 ABS	150		2017 →	FDB2287			EF		FDB2275		P/EF	
GSX-S 150 ABS	150		2017 →	FDB2287			EF		FDB2275		P/EF	
SIXTEEN 150 UH	150		2008 →	FDB2196			ST/SM/P/EF		FDB2148		SG/EF	
UC 150 EPICURO	150		1998 → 2000	FDB2133			SG/EF		FSB957			
UC 150 EPICURO	150		2001 → 2002	FDB2133			SG/EF		FDB2133		SG/EF	
UH 150 BURGMAN (BR11)	150	11	2002 → 2006	FDB2018			ZR/ST/SG/P/EF		FDB2074		ST/SM/P/EF/CPRO/AG	
UH 150 BURGMAN	150	11	2007 → 2013	FDB2196			ST/SM/P/EF		FDB2148		SG/EF	
PE 175 C - CE2 - N	175		1978 → 1979	FSB721					FSB721			
PE 175 T - X	175		1980 → 1981	FSB721					FSB775			
PE 175 Z	175		1982 →	FSB776					FSB775			
GT 185 A - B - C	185		1974 → 1979						FSB721			
GT 185 EC - L - M	185		1974 → 1979						FSB721			
TS 185 B - C	185		1974 → 1981	FSB721					FSB721			
TS 185 ERN - ERT - ERX	185		1974 → 1981	FSB721					FSB721			
TS 185 K	185		1973 → 1973	FSB722					FSB721			
TS 185 L - M	185		1974 → 1981	FSB721					FSB721			
DR 200	200		2000 →	FDB250			SG/P/EF					
DR 200 K	200		1989 → 1998	FDB250			SG/P/EF		FSB721			
GT 200 EN - EX	200		1979 → 1982	FDB178			P		FSB721			
GT 200 X 5	200		1979 → 1982	FDB178			P		FSB721			
RG 200 GAMMA	200		1993 → 1994	FDB574			ZRAC/XRAC/ST/P/EF/CP1		FDB607		P	
RG 200 WOLF	200		1993 → 1994	FDB481			ST/P/EF		FDB607		P	
SB 200 N - X	200		1979 → 1981	FSB724					FSB721			
TS 200 R	200		1990 → 1994	FDB497			ST/SM/SG/P/EF		FDB659		SG/P/EF	
UH 200 BURGMAN	200		2007 → 2013	FDB2196			ST/SM/P/EF		FDB2148		SG/EF	
UH 200 BURGMAN ABS	200		2014 →	FDB631			ST/SM/SG/P/EF/AG		FDB2148		SG/EF	
VAN VAN 200	200		2016 →	FDB2049			XRAC/ST/P/EF/CP1		FSB722			
TS 240 X	240		1988 → 1990	FDB661			SG/P		FSB728			
ACROSS 250	250		1990 →	FDB481			ST/P/EF		FDB338		ST/P/EF	
AN 250 BURGMAN K1/K2	250		2001 → 2002	FDB2085			ST/SM/P/EF		FDB2132		EF	
AN 250 K3-K6 BURGMAN (CJ43A)	250		2003 → 2006	FDB2085			ST/SM/P/EF		FDB2132		EF	
AN 250 Skywave Type M (BA-CJ45A)	250		2007 → 2008	FDB497		left	ST/SM/SG/P/EF					
AN 250 Skywave Type M (BA-CJ45A)	250		2007 → 2008	FDB631		right	ST/SM/SG/P/EF/AG					
AN 250 Skywave Type M (BA-CJ45A)	250		2007 → 2008						FDB2173		ST/SM/EF	
AN 250 Skywave Type S (BA-CJ44A)	250		2007 → 2008	FDB497		left	ST/SM/SG/P/EF					
AN 250 Skywave Type S (BA-CJ44A)	250		2007 → 2008	FDB631		right	ST/SM/SG/P/EF/AG					
AN 250 Skywave Type S (BA-CJ44A)	250		2007 → 2008						FDB2173		ST/SM/EF	
AN 250 8 Skywave SS	250		2008 →	FDB497		left	ST/SM/SG/P/EF					
AN 250 8 Skywave SS	250		2008 →	FDB631		right	ST/SM/SG/P/EF/AG					
AN 250 8 Skywave SS	250		2008 →						FDB2173		ST/SM/EF	
AN 250 BURGMAN W/X/Y	250		1996 → 2002	FDB2085			ST/SM/P/EF		FDB2086		P/EF	
250 BANDIT	250		1990 →	FDB481			ST/P/EF		FDB338		ST/P/EF	
COBRA 250	250		1989 →	FDB574			ZRAC/XRAC/ST/P/EF/CP1		FDB338		ST/P/EF	
COBRA 250	250		1990 →	FDB574			ZRAC/XRAC/ST/P/EF/CP1		FDB338		ST/P/EF	
DJEBEL 250	250		1993 →	FDB497			ST/SM/SG/P/EF		FDB659		SG/P/EF	
DR 250	250		1981 → 1982	FSB721					FSB721			
DR 250 S	250		1983 → 1984	FSB785					FSB721			
DR 250 S	250		1985 →	FDB673			P		FSB721			
DR 250 S	250		1986 → 1989	FDB250			SG/P/EF		FSB721			
DR 250 S	250		1990 → 2000	FDB497			ST/SM/SG/P/EF		FDB659		SG/P/EF	
GF 250 S	250		1986 →	FDB390	2		P		FDB338		ST/P/EF	
GN 250	250		1993 → 1997	FDB218			P		FSB721			
GN 250 F / J	250		1983 → 1997	FDB218			P		FSB725			
GNX 250 E	250		1983 →	FDB218			P		FSB725			
GOOSE 250	250		1992 →	FDB574			ZRAC/XRAC/ST/P/EF/CP1		FDB338		ST/P/EF	
GS 250 E	250		1979 → 1981	FDB218			P		FSB725			
GS 250 FW	250		1984 →	FDB338			ST/P/EF		FDB338		ST/P/EF	
GS 250 T - TT - TX	250		1979 → 1981	FDB218			P		FSB725			
GSF 250 BANDIT	250		1990 →	FDB481	2		ST/P/EF		FDB338		ST/P/EF	
GSX 250 E - ET - EX - EZ - T	250		1979 →	FDB218			P		FSB725			
GSX 250 S	250		1985 → 1990	FDB218			P		FSB725			
GSX 250 S KATANA	250		1991 →	FDB481	2		ST/P/EF		FDB338		ST/P/EF	
GSX 250 R ABS	250		2017 →	FDB570			XRAC/ST/SM/P/EF/CPRO		FDB2258		ST/EF	
GSX-R 250	250		1987 → 1988	FDB389	2		ST/P		FDB338		ST/P/EF	
GSX-R 250 R - R/SP	250		1989 →	FDB574	2		ZRAC/XRAC/ST/P/EF/CP1		FDB338		ST/P/EF	
GT 250 A - B - C	250		1973 → 1978						FSB773			
GT 250 EN - ET - EX	250		1978 →	FDB178			P		FSB725			
GT 250 K - L - M	250		1973 → 1978						FSB773			
GT 250 X7	250		1978 →	FDB178			P		FSB725			
GZ 250 MARAUDER	250		2000 →	FDB404			P		FSB721			
Inazuma 250	250		2013 →	FDB570			XRAC/ST/SM/P/EF/CPRO		FDB2258		ST/EF	
Inazuma 250F	250		2015 →	FDB570			XRAC/ST/SM/P/EF/CPRO		FDB2258		ST/EF	
Inazuma 250Z	250		2015 →	FDB570			XRAC/ST/SM/P/EF/CPRO		FDB2258		ST/EF	

* It is recommended that in those applications where sintered pads are supplied as Original Equipment, replacement pads should also be of sintered composition.

** To avoid brake imbalance sintered pads fitted in rear calipers should only be used in combination with front calipers containing sintered pads.



CC KW FROM -> TO N° SET L/R COMPOUND N° SET L/R COMPOUND

...SUZUKI

PE 250 B - C	250	1977 → 1978	FSB724				FSB724			
PE 250 N	250	1979 → 1979	FSB722				FSB722			
PE 250 T	250	1980 → 1980	FSB724				FSB724			
PE 250 X - Z	250	1981 → 1982	FSB722				FSB724			
RG 250 W GAMMA	250	→ 1983	FDB338	2		ST/P/EF	FDB338			ST/P/EF
RG 250 W GAMMA	250	1984 → 1987	FDB390			P	FDB338			ST/P/EF
RGV 250 R	250	1988 →	FDB557	2		XRAC/ST/P/EF/CP1	FDB338			ST/P/EF
RGV 250 R	250	1989 →	FDB574	2		ZRAC/XRAC/ST/P/EF/CP1	FDB338			ST/P/EF
RGV 250 R	250	1990 → 1992	FDB574	2		ZRAC/XRAC/ST/P/EF/CP1	FDB508			P
RGV 250	250	1993 →	FDB574	2		ZRAC/XRAC/ST/P/EF/CP1	FDB607			P
RGV 250	250	1994 → 1996	FDB574	2		ZRAC/XRAC/ST/P/EF/CP1	FDB508			P
RH 250 X	250	1987 →	FDB250			SG/P/EF				
RM 250 A - B - C	250	1976 → 1978	FSB721				FSB724			
RM 250 F - IG - G	250	1985 → 1986	FDB404			P	FSB776			
RM 250	250	1991 → 1992	FDB497			ST/SM/SG/P/EF	FDB659			SG/P/EF
RM 250 T/V	250	1996 → 1999	FDB892			ZR/SG/P/EF/CPRO	FDB539			SG/P/EF
RM 250	250	2000 → 2008	FDB892			ZR/SG/P/EF/CPRO	FDB539			SG/P/EF
RM 250	250	2009 →	FDB892			ZR/SG/P/EF/CPRO	FDB2162			SG/P/EF
RM 250 D	250	1983 →	FSB778				FSB786			
RM 250 E	250	1984 →	FSB778				FSB776			
RM 250 H	250	1987 → 1988	FDB497			ST/SM/SG/P/EF	FDB661			SG/P
RM 250 K - L - M	250	1989 → 1994	FDB497			ST/SM/SG/P/EF	FDB659			SG/P/EF
RM 250 N	250	1979 →	FSB724				FSB785			
RM 250 R-S	250	1993 → 1995	FDB497			ST/SM/SG/P/EF	FDB659			SG/P/EF
RM 250 T	250	1980 →	FSB776				FSB785			
RM 250 XZ	250	1981 → 1982	FSB779				FSB786			
RM-Z 250	250	2004 → 2018	FDB892			ZR/SG/P/EF/CPRO	FDB2162			SG/P/EF
RM-Z 250 / E	250	2009 →	FDB892			ZR/SG/P/EF/CPRO	FDB2162			SG/P/EF
RM-Z 250	250	2019 →	FDB892			ZR/SG/P/EF/CPRO	FDB2162			SG/P/EF
RMX 250 RP	250	1989 → 1995	FDB497			ST/SM/SG/P/EF	FDB659			SG/P/EF
RMX 250 T/V	250	1996 → 1998	FDB892			ZR/SG/P/EF/CPRO	FDB659			SG/P/EF
RMX 250	250	2000 → 2002	FDB892			ZR/SG/P/EF/CPRO	FDB659			SG/P/EF
SKY WAVE 250 (type II)	250	1998 →	FDB2085			ST/SM/P/EF	FDB2086			P/EF
SW1 250	250	1992 →	FDB481			ST/P/EF				
TS 250 all models	250	1974 → 1982	FSB724				FSB724			
TS 250 X all models 250	250	1986 → 1989	FDB250			SG/P/EF	FSB724			
TU 250 X	250	1997 → 2000	FDB404			P	FSB721			
V-Strom 250 ABS	250	2017 →	FDB570			XRAC/ST/SM/P/EF/CPRO	FDB2258			ST/EF
VL 250 INTRUDER	250	2000 → 2001	FDB404			P	FSB721			
VOLTY 250	250	1995 → 2000	FDB404			P				
WOLF 250	250	1990 →	FDB529			P	FDB338			ST/P/EF
DR 350	350	1990 →	FDB497			ST/SM/SG/P/EF	FDB659			SG/P/EF
DR 350 S-SH-SE	350	1993 → 1997	FDB497			ST/SM/SG/P/EF	FDB659			SG/P/EF
GOOSE 350	350	1992 →	FDB574			ZRAC/XRAC/ST/P/EF/CP1	FDB338			ST/P/EF
SP 370 C - N	370	1977 →	FSB724				FSB724			
GT 380 J	380	→ 1972					FSB773			
GT 380 K/L/M/A/B	380	1973 → 1977					FSB773			
AN 400 BURGMAN	400	1999 → 2000	FDB2085			ST/SM/P/EF	FDB2086			P/EF
AN 400 BURGMAN	400	2001 → 2006	FDB2085			ST/SM/P/EF	FDB2132			EF
AN 400 BURGMAN/SKYWAVE ABS	400	2007 →	FDB497		left	ST/SM/SG/P/EF				
AN 400 BURGMAN/SKYWAVE ABS	400	2007 →	FDB631		right	ST/SM/SG/P/EF/AG				
AN 400 BURGMAN/SKYWAVE ABS	400	2007 →					FDB2173			ST/SM/EF
AN 400 BURGMAN/SKYWAVE NO ABS	400	2007 →	FDB497		left	ST/SM/SG/P/EF				
AN 400 BURGMAN/SKYWAVE NO ABS	400	2007 →	FDB631		right	ST/SM/SG/P/EF/AG				
AN 400 BURGMAN/SKYWAVE NO ABS	400	2007 →					FDB2173			ST/SM/EF
BURGMAN 400 ABS	400	2017 →	FDB497		left	ST/SM/SG/P/EF				
BURGMAN 400 ABS	400	2017 →	FDB631		right	ST/SM/SG/P/EF/AG				
BURGMAN 400 ABS	400	2017 →					FDB2173			ST/SM/EF
DR 400 ST - SX	400	1979 → 1981	FSB724				FSB724			
DR-Z 400 E	400	2000 →	FDB892			ZR/SG/P/EF/CPRO	FDB539			SG/P/EF
DR-Z 400 S	400	2000 →	FDB892			ZR/SG/P/EF/CPRO	FDB539			SG/P/EF
DR-Z 400 SM	400	2005 →	FDB892			ZR/SG/P/EF/CPRO	FDB539			SG/P/EF
GN 400 TT	400	1980 →	FDB218			P	FSB725			
GS 400 B - C	400	1977 → 1978	FDB150			P	FSB773			
GSF 400 S KATANA	400	1989 → 1990	FDB574			ZRAC/XRAC/ST/P/EF/CP1	FDB338			ST/P/EF
GSF 400 BANDIT	400	1991 → 1992	FDB481	2		ST/P/EF	FDB338			ST/P/EF
GSF 400 BANDIT	400	1993 → 1994	FDB574	2		ZRAC/XRAC/ST/P/EF/CP1	FDB338			ST/P/EF
GSF 400 BANDIT	400	1995 → 1997	FDB570	2		XRAC/ST/SM/P/EF/CPRO	FDB338			ST/P/EF
GSX 400 ET - EX - EZ	400	1980 → 1983	FDB218			P	FSB725			
GSX 400 L	400	1980 → 1983	FDB218			P	FSB725			
GSX 400 TWIN	400	1980 → 1983	FDB218			P	FSB725			
GSX 400 F (FOUR) FZ	400	1981 → 1983	FDB314			ST/SG/P/EF				
GSX 400 FD	400	1981 → 1983	FDB314			ST/SG/P/EF				
GSX 400 TX - LX	400	1981 → 1983	FDB218			P	FSB773			

* It is recommended that in those applications where sintered pads are supplied as Original Equipment, replacement pads should also be of sintered composition.

** To avoid brake imbalance sintered pads fitted in rear calipers should only be used in combination with front calipers containing sintered pads.



CC KW FROM -> TO N° SET L/R COMPOUND N° SET L/R COMPOUND

...SUZUKI

GSX 400 FWS - D - E	400	1983 →	FDB338	2		ST/P/EF	FDB338		ST/P/EF
GSX 400 S	400	1983 →	FDB338	2		ST/P/EF	FDB338		ST/P/EF
GSX 400 R I/II	400	1985 → 1986	FDB390	2		P	FDB338		ST/P/EF
GSX 400 X IMPULSE 400	400	1986 → 1988	FDB389	2		ST/P	FDB338		ST/P/EF
GSX 400 KATANA	400	1989 → 1992	FDB574	2		ZRAC/XRAC/ST/P/EF/CP1	FDB338		ST/P/EF
GSX 400 IMPULSE	400	1994 → 1996	FDB570	2		XRAC/ST/SM/P/EF/CPRO	FDB338		ST/P/EF
GSX-R 400 (III-IV)	400	→ 1988	FDB389	2		ST/P	FDB338		ST/P/EF
GSX-R 400 (JAPAN)	400	1985 →	FDB338	2		ST/P/EF	FDB390		P
GSX-R 400 (V)	400	1989 → 1990	FDB574			ZRAC/XRAC/ST/P/EF/CP1	FDB338		ST/P/EF
GSX-R 400	400	1990 →	FDB605			ZRAC/XRAC/ST/SM/P/EF/CPRO	FDB338		ST/P/EF
GSX-R 400 R	400	1990 → 1995	FDB557	2		XRAC/ST/P/EF/CP1	FDB338		ST/P/EF
LS 400 SAVAGE	400	1987 →	FSB724				FSB724		
PE 400 T	400	1979 → 1981	FSB722				FSB724		
PE 400 X	400	1979 → 1981	FSB722				FSB724		
RF 400 RVC	400	1993 →	FDB570			XRAC/ST/SM/P/EF/CPRO	FDB338		ST/P/EF
RG 400 GAMMA	400	1985 →	FDB389	2		ST/P	FDB338		ST/P/EF
RM 400 C	400	1978 → 1978	FSB721				FSB724		
RM 400 N	400	1979 → 1979	FSB724				FSB785		
RM 400 T	400	1980 →	FSB776				FSB785		
SP 400	400	1979 →	FSB724				FSB724		
ST 400	400	1979 →	FSB724				FSB724		
SX 400	400	1979 →	FSB724				FSB724		
GS 425 EN	425	1978 → 1980	FDB150			P	FSB725		
GS 450 ET - L - T	450	1980 → 1980	FDB218			P	FSB725		
GS 450 S	450	1987 →	FDB314	2		ST/SG/P/EF	FDB338		ST/P/EF
RM-Z 450	450	2005 → 2007	FDB892			ZR/SG/P/EF/CPRO	FDB2162		SG/P/EF
RM-Z 450 / E	450	2008 →	FDB892			ZR/SG/P/EF/CPRO	FDB2162		SG/P/EF
RMX 450 E	450	2009 →	FDB892			ZR/SG/P/EF/CPRO	FDB2162		SG/P/EF
SM 450X	450	2009 →	FDB892			ZR/SG/P/EF/CPRO	FDB2162		SG/P/EF
RM 465 X - Z	465	1981 → 1982	FSB779				FSB776		
DR 500 SD - SE	500	1983 →	FSB724				FSB724		
DR 500 S	500	1989 →	FDB673			P	FSB721		
GS 500 EK - EL	500	1981 → 1988	FDB178	2		P			
GS 500 E - K - L - M	500	1989 → 1993	FDB481			ST/P/EF	FDB338		ST/P/EF
GS 500 E - K - FK	500	1996 →	FDB2049			XRAC/ST/P/EF/CP1	FDB338		ST/P/EF
GT 500 A - B	500	1976 → 1978					FSB773		
RE 500 S A - M	500	1975 → 1977	FDB178			P	FSB782		
RG 500 RF GAMMA	500	1985 → 1987	FDB389	2		ST/P	FDB338		ST/P/EF
RGV 500 GAMMA	500	1990 →	FDB574	2		ZRAC/XRAC/ST/P/EF/CP1	FDB508		P
RM 500	500	1987 →	FDB497			ST/SM/SG/P/EF	FDB661		SG/P
RM 500 D - E	500	1983 → 1984	FSB778				FSB721		
RM 500 F	500	1985 → 1986	FDB404			P	FSB721		
T 500 all models	500	1968 → 1975					FSB773		
GS 550 B - C - D	550	1977 → 1978	FDB178	2		P	FSB780		
GS 550 EC - EN	550	1978 → 1979	FDB178	2		P			
GS 550 ET - EX - EZ	550	1980 → 1984	FDB217	2		P			
GS 550 LT - LX	550	1980 → 1984	FDB217	2		P			
GS 550 MEX	550	1981 → 1983	FDB217	2		P			
GS 550 MEZ KATANA	550	1981 → 1983	FDB217	2		P			
GSX 550 EF - EFE	550	1983 → 1987	FDB338	2		ST/P/EF	FDB338		ST/P/EF
GSX 550 ES - ESE	550	1983 → 1987	FDB338	2		ST/P/EF	FDB338		ST/P/EF
GSX 550 ESD - ES4	550	1983 → 1987	FDB338	2		ST/P/EF	FDB338		ST/P/EF
GSX 550 ET - EV	550	1987 →	FDB338	2		ST/P/EF	FDB338		ST/P/EF
GT 550 A - B	550	1976 → 1977					FSB780		
GT 550 J	550	→ 1972					FSB773		
GT 550 J	550	1972 → 1972					FSB773		
GT 550 K - L - M	550	1973 → 1975					FSB773		
DR 600 S - SU	600	1985 → 1986	FDB673			P	FSB721		
DR 600 R DAKAR-DJEBEL	600	1987 → 1988	FDB673			P	FSB721		
DR 600 DJEBEL - DAKAR	600	1989 →	FDB673			P	FDB607		P
DR 600 S	600	1989 →	FDB673			P	FSB721		
GSF 600 BANDIT	600	1995 → 1999	FDB570	2		XRAC/ST/SM/P/EF/CPRO	FDB338		ST/P/EF
GSF 600 BANDIT - KATANA	600	1998 →	FDB2048		left	XRAC/ST/P/EF/CP1			
GSF 600 BANDIT - KATANA	600	1998 →	FDB2049		right	XRAC/ST/P/EF/CP1			
GSF 600 BANDIT - KATANA	600	1998 →					FDB338		ST/P/EF
GSF 600 BANDIT	600	2000 →	FDB2048		left	XRAC/ST/P/EF/CP1			
GSF 600 BANDIT	600	2000 →	FDB2049		right	XRAC/ST/P/EF/CP1			
GSF 600 BANDIT	600	2000 →					FDB338		ST/P/EF
GSR 600 /A / ABS	600	2006 → 2008	FDB574	2		ZRAC/XRAC/ST/P/EF/CP1	FDB2213		ST/P
GSX 600 F KATANA	600	1988 → 1993	FDB569	2		ST/P	FDB338		ST/P/EF
GSX-R 600 F	600	1994 → 1995	FDB570	2		XRAC/ST/SM/P/EF/CPRO	FDB338		ST/P/EF
GSX-R 600 V	600	1996 → 2003	FDB574	2		ZRAC/XRAC/ST/P/EF/CP1	FDB338		ST/P/EF
GSX-R 600	600	2004 → 2005	FDB2178	2		ZRAC/XRAC/ST	FDB2111		ST/P/EF
GSX-R 600 - Racing Applications	600	2004 → 2005	FDB2204	2		ZRAC/XRAC/CP1	FDB2111		ST/P/EF

* It is recommended that in those applications where sintered pads are supplied as Original Equipment, replacement pads should also be of sintered composition.

** To avoid brake imbalance sintered pads fitted in rear calipers should only be used in combination with front calipers containing sintered pads.



CC KW FROM -> TO N° SET L/R COMPOUND N° SET L/R COMPOUND

...SUZUKI

GSX-R 600	600	2006 → 2010	FDB2178	2		ZRAC/XRAC/ST	FDB2213		ST/P
GSX-R 600 - Racing Applications	600	2006 →	FDB2204	2		ZRAC/XRAC/CP1	FDB2213		ST/P
GSX-R 600	600	2011 →	FDB2260	2		XRAC/ST/CPRO	FDB2221		ST/P
RF 600 RR	600	1993 → 1997	FDB570	2		XRAC/ST/SM/P/EF/CPRO	FDB338		ST/P/EF
SP 600	600	1985 →	FDB673			P	FSB721		
VS 600 GL INTRUDER	600	1997 → 1999	FDB389			ST/P	FSB784		
SV 650 X ABS	645	56 2018 →	FDB2048		left	XRAC/ST/P/EF/CP1			
SV 650 X ABS	645	56 2018 →	FDB2049		right	XRAC/ST/P/EF/CP1	FDB2258	right	ST/EF
AN 650 BURGMAN Std/Skywave No ABS	650	2003 →	FDB570	2		XRAC/ST/SM/P/EF/CPRO	FDB2173		ST/SM/EF
AN 650 BURGMAN Executive/Skywave ABS	650	2004 →	FDB570	2		XRAC/ST/SM/P/EF/CPRO	FDB2173		ST/SM/EF
DL V-STROM 650 AK ABS	650	2007 → 2011	FDB2048		left	XRAC/ST/P/EF/CP1			
DL V-STROM 650 AK ABS	650	2007 → 2011	FDB2049		right	XRAC/ST/P/EF/CP1			
DL V-STROM 650 AK ABS	650	2007 → 2011					FDB754		ST/P/EF
DL V-STROM 650 XK NO ABS	650	2007 → 2011	FDB2048		left	XRAC/ST/P/EF/CP1			
DL V-STROM 650 XK NO ABS	650	2007 → 2011	FDB2049		right	XRAC/ST/P/EF/CP1			
DL V-STROM 650 XK NO ABS	650	2007 → 2011					FDB754		ST/P/EF
DL V-STROM 650AK GT Traveller ABS	650	2007 → 2011	FDB2048		left	XRAC/ST/P/EF/CP1			
DL V-STROM 650AK GT Traveller ABS	650	2007 → 2011	FDB2049		right	XRAC/ST/P/EF/CP1			
DL V-STROM 650AK GT Traveller ABS	650	2007 → 2011					FDB754		ST/P/EF
DL V-STROM 650AL XP Xpedition ABS	650	2011 → 2011	FDB2048		left	XRAC/ST/P/EF/CP1			
DL V-STROM 650AL XP Xpedition ABS	650	2011 → 2011	FDB2049		right	XRAC/ST/P/EF/CP1			
DL V-STROM 650AL XP Xpedition ABS	650	2011 → 2011					FDB754		ST/P/EF
DL V-STROM 650 AL ABS	650	2012 →	FDB2048		left	XRAC/ST/P/EF/CP1			
DL V-STROM 650 AL ABS	650	2012 →	FDB2049		right	XRAC/ST/P/EF/CP1			
DL V-STROM 650 AL ABS	650	2012 →					FDB754		ST/P/EF
DL V-STROM 650 A XT ABS	650	2015 →	FDB2048		left	XRAC/ST/P/EF/CP1			
DL V-STROM 650 A XT ABS	650	2015 →	FDB2049		right	XRAC/ST/P/EF/CP1			
DL V-STROM 650 A XT ABS	650	2015 →					FDB754		ST/P/EF
DR 650 RS-R DAKAR	650	1990 →	FDB673			P	FDB607		P
DR 650 R-RS-RSE-DJEBEL-DAKAR	650	1991 → 1995	FDB606			P	FDB607		P
DR 650 SE	650	1996 →	FDB892			ZR/SG/P/EF/CPRO	FDB659		SG/P/EF
GR 650 - X	650	1983 →	FDB217			P	FSB725		
GS 650 GTX - GTZ - GX	650	1981 → 1983	FDB217	2		P			
GS 650 GZ KATANA	650	1981 → 1983	FDB217	2		P			
GS 650 TURBO	650	1983 →	FDB217	2		P			
GS 650 XN - 85 TURBO	650	1983 →	FDB217	2		P			
GSF 650 (Naked Bandid - Non ABS)	650	2005 → 2006	FDB2048		left	XRAC/ST/P/EF/CP1			
GSF 650 (Naked Bandid - Non ABS)	650	2005 → 2006	FDB2049		right	XRAC/ST/P/EF/CP1			
GSF 650 (Naked Bandid - Non ABS)	650	2005 → 2006					FDB2111		ST/P/EF
GSF 650 (Naked Bandid Non ABS)	650	2007 → 2011	FDB574	2		ZRAC/XRAC/ST/P/EF/CP1	FDB754		ST/P/EF
GSF 650 A (Naked Bandid -ABS)	650	2005 → 2006	FDB2048		left	XRAC/ST/P/EF/CP1			
GSF 650 A (Naked Bandid -ABS)	650	2005 → 2006	FDB2049		right	XRAC/ST/P/EF/CP1			
GSF 650 A (Naked Bandid -ABS)	650	2005 → 2006					FDB754		ST/P/EF
GSF 650 A (Naked Bandid ABS)	650	2007 → 2011	FDB574	2		ZRAC/XRAC/ST/P/EF/CP1	FDB754		ST/P/EF
GSF 650 S (Faired Bandid -Non ABS)	650	2005 → 2006	FDB2048		left	XRAC/ST/P/EF/CP1			
GSF 650 S (Faired Bandid -Non ABS)	650	2005 → 2006	FDB2049		right	XRAC/ST/P/EF/CP1			
GSF 650 S (Faired Bandid -Non ABS)	650	2005 → 2006					FDB2111		ST/P/EF
GSF 650 S (Faired Bandid Non ABS)	650	2007 → 2011	FDB574	2		ZRAC/XRAC/ST/P/EF/CP1	FDB754		ST/P/EF
GSF 650 SA (Faired Bandid -ABS)	650	2005 → 2006	FDB2048		left	XRAC/ST/P/EF/CP1			
GSF 650 SA (Faired Bandid -ABS)	650	2005 → 2006	FDB2049		right	XRAC/ST/P/EF/CP1			
GSF 650 SA (Faired Bandid -ABS)	650	2005 → 2006					FDB754		ST/P/EF
GSF 650 SA (Faired Bandid ABS)	650	2007 →	FDB574	2		ZRAC/XRAC/ST/P/EF/CP1	FDB754		ST/P/EF
GSX 650F (ABS)	650	2008 →	FDB574	2		ZRAC/XRAC/ST/P/EF/CP1	FDB754		ST/P/EF
GSX 650F (NO ABS)	650	2008 → 2011	FDB574	2		ZRAC/XRAC/ST/P/EF/CP1	FDB754		ST/P/EF
LS 650 SAVAGE	650	1987 → 1999	FDB404			P	FSB725		
LS 650 P	650	1993 →	FDB673			P	FSB725		
SV 650 (Naked - Non ABS)	650	1999 → 2002	FDB2048		left	XRAC/ST/P/EF/CP1			
SV 650 (Naked - Non ABS)	650	1999 → 2002	FDB2049		right	XRAC/ST/P/EF/CP1			
SV 650 (Naked - Non ABS)	650	1999 → 2002					FDB338		ST/P/EF
SV 650 S (Top Fairing - Non ABS)	650	1999 → 2002	FDB2048		left	XRAC/ST/P/EF/CP1			
SV 650 S (Top Fairing - Non ABS)	650	1999 → 2002	FDB2049		right	XRAC/ST/P/EF/CP1			
SV 650 S (Top Fairing - Non ABS)	650	1999 → 2002					FDB338		ST/P/EF
SV 650 (Naked - Non ABS)	650	2003 → 2010	FDB2048		left	XRAC/ST/P/EF/CP1			
SV 650 (Naked - Non ABS)	650	2003 → 2010	FDB2049		right	XRAC/ST/P/EF/CP1			
SV 650 (Naked - Non ABS)	650	2003 → 2010					FDB754		ST/P/EF
SV 650 S (Top Fairing - Non ABS)	650	2003 → 2012	FDB2048		left	XRAC/ST/P/EF/CP1			
SV 650 S (Top Fairing - Non ABS)	650	2003 → 2012	FDB2049		right	XRAC/ST/P/EF/CP1			
SV 650 S (Top Fairing - Non ABS)	650	2003 → 2012					FDB754		ST/P/EF
SV 650 A (Naked - ABS)	650	2007 → 2010	FDB2048		left	XRAC/ST/P/EF/CP1			
SV 650 A (Naked - ABS)	650	2007 → 2010	FDB2049		right	XRAC/ST/P/EF/CP1			
SV 650 A (Naked - ABS)	650	2007 → 2010					FDB754		ST/P/EF
SV 650 SA (Top Fairing - ABS)	650	2007 → 2013	FDB2048		left	XRAC/ST/P/EF/CP1			
SV 650 SA (Top Fairing - ABS)	650	2007 → 2013	FDB2049		right	XRAC/ST/P/EF/CP1			
SV 650 SA (Top Fairing - ABS)	650	2007 → 2013					FDB754		ST/P/EF

* It is recommended that in those applications where sintered pads are supplied as Original Equipment, replacement pads should also be of sintered composition.

** To avoid brake imbalance sintered pads fitted in rear calipers should only be used in combination with front calipers containing sintered pads.



CC KW FROM -> TO N° SET L/R COMPOUND N° SET L/R COMPOUND

...SUZUKI

SV 650 ABS	650	2016	→	FDB2048		left	XRAC/ST/P/EF/CP1				
SV 650 ABS	650	2016	→	FDB2049		right	XRAC/ST/P/EF/CP1	FDB2258		right	ST/EF
SFV GLADIUS 650 ABS	650	2009	→	FDB2048		left	XRAC/ST/P/EF/CP1				
SFV GLADIUS 650 ABS	650	2009	→	FDB2049		right	XRAC/ST/P/EF/CP1				
SFV GLADIUS 650 ABS	650	2009	→					FDB2258			ST/EF
SFV GLADIUS 650 NO ABS	650	2009	→	FDB2048		left	XRAC/ST/P/EF/CP1				
SFV GLADIUS 650 NO ABS	650	2009	→	FDB2049		right	XRAC/ST/P/EF/CP1				
SFV GLADIUS 650 NO ABS	650	2009	→					FDB2258			ST/EF
V-Strom 650 ABS	650	2016	→	FDB2048		left	XRAC/ST/P/EF/CP1				
V-Strom 650 ABS	650	2016	→	FDB2049		right	XRAC/ST/P/EF/CP1				
V-Strom 650 ABS	650	2016	→					FDB754			ST/P/EF
V-Strom 650-XT ABS	650	2016	→	FDB2048		left	XRAC/ST/P/EF/CP1				
V-Strom 650-XT ABS	650	2016	→	FDB2049		right	XRAC/ST/P/EF/CP1				
V-Strom 650-XT ABS	650	2016	→					FDB754			ST/P/EF
XF 650 FREEWIND	650	1997	→ 2002	FDB2049			XRAC/ST/P/EF/CP1	FDB754			ST/P/EF
GS 700 E - ES	700	1985	→	FDB218	2		P				
GV 700 GL MADURA	700	1984	→	FDB218	2		P	FSB784			
GV 700 GL	700	1985	→	FDB218	2		P	FSB782			
VS 700 GL INTRUDER	700	1985	→	FDB389			ST/P	FSB784			
DR 750 S BIG	750	1988	→	FDB606			P	FSB790			
DR 750 S BIG	750	1989	→	FDB606			P	FDB607			P
GS 750 B	750	1976	→ 1976	FDB150			P				
GS 750 DB	750	1977	→ 1980	FDB150	2		P				
GS 750 DL	750	1977	→ 1980	FDB150	2		P				
GS 750 EC	750	1977	→ 1980	FDB150	2		P				
GS 750 EN	750	1977	→ 1980	FDB150	2		P				
GSR 750 ABS&NO ABS	750	2011	→	FDB2048		left	XRAC/ST/P/EF/CP1				
GSR 750 ABS&NO ABS	750	2011	→	FDB2049		right	XRAC/ST/P/EF/CP1				
GSR 750 ABS&NO ABS	750	2011	→					FDB754			ST/P/EF
GSX 750 EFE - ESD - ESG - ESE - SEH - EFF	750	1980	→ 1986	FDB218	2		P				
GSX 750 ET - EX	750	1980	→ 1981	FDB218	2		P				
GSX 750 S KATANA	750	1980	→	FDB218	2		P				
GSX 750 LIMITED EDITION	750	1986	→	FDB389	2		ST/P	FDB338			ST/P/EF
GSX 750 EF	750	1987	→	FDB389	2		ST/P	FDB338			ST/P/EF
GSX 750 FK/FL/FM/FN/FP/FR/FS/FT/FV	750	1989	→ 1997	FDB569	2		ST/P	FDB338			ST/P/EF
GSX 750 FW/FX/FY/FK1/FK2	750	1998	→ 2006	FDB2048		left	XRAC/ST/P/EF/CP1				
GSX 750 FW/FX/FY/FK1/FK2	750	1998	→ 2006	FDB2049		right	XRAC/ST/P/EF/CP1				
GSX 750 FW/FX/FY/FK1/FK2	750	1998	→ 2006					FDB338			ST/P/EF
GSX 750 W/X/Y/K1	750	1998	→	FDB2048		left	XRAC/ST/P/EF/CP1				
GSX 750 W/X/Y/K1	750	1998	→	FDB2049		right	XRAC/ST/P/EF/CP1				
GSX 750 W/X/Y/K1	750	1998	→					FDB338			ST/P/EF
GSX-R 750 LTD Special Edition	750	1987	→ 1988	FDB389	2		ST/P	FDB338			ST/P/EF
GSX-R 750	750	1988	→ 1993	FDB557	2		XRAC/ST/P/EF/CP1	FDB338			ST/P/EF
GSX-R 750 W	750	1994	→ 1999	FDB873	2		ZRAC/XRAC/ST/P/EF/CP1	FDB338			ST/P/EF
GSX-R 750 W (Racing Applications)	750	1994	→ 1999	FDB2144	2		XRAC/ST/P	FDB338			ST/P/EF
GSX-R 750 Y	750	2000	→ 2003	FDB574	2		ZRAC/XRAC/ST/P/EF/CP1	FDB338			ST/P/EF
GSX-R 750 - Racing Applications	750	2004	→ 2005	FDB2204	2		ZRAC/XRAC/CP1	FDB2111			ST/P/EF
GSX-R 750 - Racing Applications	750	2006	→	FDB2204	2		ZRAC/XRAC/CP1	FDB2213			ST/P
GSX-R 750	750	2011	→	FDB2260	2		XRAC/ST/CPRO	FDB2221			ST/P
GSX-S 750 ABS	750	2016	→	FDB2158	2		ST	FDB754			ST/P/EF
GT 750 A - B - K - L - M	750	1973	→ 1977					FSB782			
GT 750 RF	750	1985	→ 1986	FDB389	2		ST/P	FDB338			ST/P/EF
VS 750 INTRUDER (All Models)	750	1985	→ 1991	FDB389			ST/P	FSB784			
DR 800 Z	800	1988	→ 1989	FDB606			P	FDB661			SG/P
DR 800 BIG S - SU	800	1990	→	FDB606			P	FDB607			P
DR 800 BIG all models	800	1991	→	FDB481			ST/P/EF	FDB631			ST/SM/SG/P/EF/AG
INTRUDER M800 (VZ800)	800	2005	→ 2013	FDB2049			XRAC/ST/P/EF/CP1	FSB784			
INTRUDER C800 - spoke wheel (VL 800)	800	2006	→ 2013	FDB2049			XRAC/ST/P/EF/CP1	FSB784			
INTRUDER C800C - cast wheel (VL 800)	800	2007	→ 2013	FDB2049			XRAC/ST/P/EF/CP1	FSB784			
INTRUDER M800 Z (VZ800)	800	2009	→ 2010	FDB2049			XRAC/ST/P/EF/CP1	FSB784			
INTRUDER C800B - cast wheel (VL 800)	800	2014	→	FDB2049			XRAC/ST/P/EF/CP1	FSB784			
INTRUDER M800 /T (VZ800)	800	2014	→	FDB2049			XRAC/ST/P/EF/CP1	FSB784			
VL 800 INTRUDER VOLUSIA	800	2001	→ 2005	FDB2049			XRAC/ST/P/EF/CP1	FSB784			
VS 800 S INTRUDER	800	1991	→ 1992	FDB673			P	FSB784			
VS 800 GL INTRUDER (VS52B)	800	1992	→ 1999	FDB389			ST/P	FSB784			
VX 800	800	1990	→ 1994	FDB481			ST/P/EF	FDB569			ST/P
VX 800	800	1995	→	FDB2048			XRAC/ST/P/EF/CP1	FDB569			ST/P
VZ 800 MARAUDER / K7	800	1997	→ 2003	FDB2049			XRAC/ST/P/EF/CP1	FSB784			
GS 850 GN - GT - GX	850	1979	→ 1981	FDB178	2		P	FDB151			ST/PRP/P
GS 850 GZ - GE - GG	850	1982	→ 1985	FDB218	2		P	FDB151			ST/PRP/P
RF 900 RR	900	1994	→ 1995	FDB557	2		XRAC/ST/P/EF/CP1	FDB2058			P
RF 900 RT - RV	900	1996	→ 1999	FDB557	2		XRAC/ST/P/EF/CP1	FDB338			ST/P/EF
DL 1000 V-STROM (WVBS)	1000	72	2002	→ 2010	FDB2048		left	XRAC/ST/P/EF/CP1			
DL 1000 V-STROM (WVBS)	1000	72	2002	→ 2010	FDB2049		right	XRAC/ST/P/EF/CP1			

* It is recommended that in those applications where sintered pads are supplied as Original Equipment, replacement pads should also be of sintered composition.

** To avoid brake imbalance sintered pads fitted in rear calipers should only be used in combination with front calipers containing sintered pads.



CC KW FROM -> TO



N° SET L/R COMPOUND



N° SET L/R COMPOUND

...SUZUKI

Model	CC	KW	FROM -> TO	N° SET	L/R	COMPOUND	N° SET	L/R	COMPOUND
DL 1000 V-STROM (WVBS)	1000	72	2002 → 2010				FDB754		ST/P/EF
DL 1000 V-STROM ABS (DD1)	1000	74	2014 →	FDB2178	2	ZRAC/XRAC/ST	FDB2213		ST/P
GS 1000 EC - EN - HC - SN	1000		1978 → 1979	FDB178	2	P	FDB151		ST/PRP/P
GS 1000 ET	1000		1980 → 1981	FDB217	2	P	FDB151		ST/PRP/P
GS 1000 GT - GX	1000		1980 →	FDB218	2	P			
GSX 1000 S KATANA	1000		1982 →	FDB217	2	P	FDB151		ST/PRP/P
GSX-R 1000	1000		2001 → 2002	FDB873	2	ZRAC/XRAC/ST/P/EF/CPRO/CP1	FDB2111		ST/P/EF
GSX-R 1000	1000		2003 → 2003	FDB2164	2	ZRAC/XRAC/ST	FDB2111	2	ST/P/EF
GSX-R 1000	1000		2004 → 2006	FDB2178	2	ZRAC/XRAC/ST	FDB2111		ST/P/EF
GSX-R 1000	1000		2007 → 2008	FDB2178	2	ZRAC/XRAC/ST	FDB2213		ST/P
GSX-R 1000	1000		2009 → 2011	FDB2178	2	ZRAC/XRAC/ST	FDB2221		ST/P
GSX-R 1000 Alstare 25 Ann.	1000		2010 →	FDB2178	2	ZRAC/XRAC/ST	FDB2221		ST/P
GSX-R 1000 Yoshimura 2008	1000		2010 →	FDB2178	2	ZRAC/XRAC/ST	FDB2213		ST/P
GSX-R 1000 No ABS	1000		2012 →	FDB2260	2	XRAC/ST/CPRO	FDB2221		ST/P
GSX-R 1000 ABS	1000		2015 → 2019	FDB2260	2	XRAC/ST/CPRO	FDB2221		ST/P
GSX-R 1000 CONCEPT	1000		2016 →	FDB2260	2	XRAC/ST/CPRO	FDB2221		ST/P
GSX-R 1000 R ABS	1000		2017 →	FDB2260	2	XRAC/ST/CPRO	FDB2221		ST/P
GSX-R 1000 (Racing Applications)	1000		2001 → 2002	FDB2144	2	XRAC/ST/P	FDB2111		ST/P/EF
GSX-R 1000 - Racing Applications	1000		2004 → 2008	FDB2204	2	ZRAC/XRAC/CP1	FDB2111		ST/P/EF
GSX-R 1000 - Racing Applications	1000		2009 →	FDB2204	2	ZRAC/XRAC/CP1	FDB2221		ST/P
GSX-S 1000 ABS	1000		2015 →	FDB2260	2	XRAC/ST/CPRO	FDB754		ST/P/EF
GSX-S 1000 F ABS	1000		2015 →	FDB2260	2	XRAC/ST/CPRO	FDB754		ST/P/EF
SV 1000 K3/SK3	1000		2003 →	FDB574	2	ZRAC/XRAC/ST/P/EF/CP1	FDB754		ST/P/EF
TL 1000 SV TWIN	1000		1997 → 2001	FDB574	2	ZRAC/XRAC/ST/P/EF/CP1	FDB338		ST/P/EF
TL 1000 R	1000		1998 → 2002	FDB873	2	ZRAC/XRAC/ST/P/EF/CPRO/CP1	FDB338		ST/P/EF
V-Strom 1000 ABS	1037		2016 →	FDB2178	2	ZRAC/XRAC/ST	FDB2213		ST/P
V-Strom 1000-XT ABS	1037		2016 →	FDB2178	2	ZRAC/XRAC/ST	FDB2213		ST/P
V-Strom 1050	1050		2020 →	FDB2178	2	ZRAC/XRAC/ST	FDB2213		ST/P
GS 1100 GZ	1100		1982 →	FDB218	2	P			
GSX 1100 E - EF - ES	1100		1980 → 1982	FDB217	2	P			
GSX 1100 G	1100		1980 → 1982	FDB217	2	P			
GSX 1100 S KATANA	1100		1982 → 1983	FDB217	2	P			
GSX 1100 E - EF - ES	1100		1984 → 1986	FDB389	2	ST/P	FDB389		ST/P
GSX 1100 FK - L - M - N - R	1100		1988 → 1993	FDB569	2	ST/P	FDB569		ST/P
GSX 1100 GM	1100		1991 → 1992	FDB481	2	ST/P/EF	FDB338		ST/P/EF
GSX 1100 G	1100		1993 → 1996	FDB481	2	ST/P/EF	FDB508		P
GSX-R 1100	1100		1985 → 1988	FDB389	2	ST/P	FDB338		ST/P/EF
GSX-R 1100 K - L - M - N	1100		1989 → 1992	FDB557	2	XRAC/ST/P/EF/CP1	FDB338		ST/P/EF
GSX-R 1100 W (Racing Applications)	1100		1991 → 1996	FDB2144	2	XRAC/ST/P	FDB338		ST/P/EF
GSX-R 1100 W	1100		1993 → 1996	FDB873	2	ZRAC/XRAC/ST/P/EF/CPRO/CP1	FDB338		ST/P/EF
GSF 1200 T-ST-V-SV- BANDIT	1200		1995 → 2000	FDB557	2	XRAC/ST/P/EF/CP1	FDB338		ST/P/EF
GSF 1200 K1/SK1 BANDIT	1200		2001 →	FDB873	2	ZRAC/XRAC/ST/P/EF/CPRO/CP1	FDB338		ST/P/EF
GSX 1200	1200		1999 → 2000	FDB2042	2	ZRAC/XRAC/ST/P/EF/CPRO	FDB338		ST/P/EF
GV 1200 GL MADURA	1200		1985 → 1986	FDB218	2	P	FDB151		ST/PRP/P
GSF 1250 (Naked Bandit - Non ABS)	1250		2007 → 2011	FDB574	2	ZRAC/XRAC/ST/P/EF/CP1	FDB754		ST/P/EF
GSF 1250 A (Naked Bandit - ABS)	1250		2007 → 2010	FDB574	2	ZRAC/XRAC/ST/P/EF/CP1	FDB754		ST/P/EF
GSF 1250 S (Faired Bandit - Non ABS)	1250		2007 → 2010	FDB574	2	ZRAC/XRAC/ST/P/EF/CP1	FDB754		ST/P/EF
GSF 1250 SA (Faired Bandit - ABS)	1250		2007 → 2012	FDB574	2	ZRAC/XRAC/ST/P/EF/CP1	FDB754		ST/P/EF
GSF 1250 SA (Faired Bandit - ABS)	1250		2015 →	FDB574	2	ZRAC/XRAC/ST/P/EF/CP1	FDB754		ST/P/EF
GSX 1250 FA	1250		2010 →	FDB574	2	ZRAC/XRAC/ST/P/EF/CP1	FDB754		ST/P/EF
GSX 1250 FA ST (Sport Touring)	1250		2010 →	FDB574	2	ZRAC/XRAC/ST/P/EF/CP1	FDB754		ST/P/EF
GSX 1300 B-KING / Hyaku	1300		2007 →	FDB2158	2	ST	FDB2213		ST/P
GSX-R 1300 HAYABUSA (Racing Applications)	1300		1999 → 2007	FDB2144	2	XRAC/ST/P	FDB338		ST/P/EF
GSX-R 1300	1300		2008 →	FDB2178	2	ZRAC/XRAC/ST	FDB2213		ST/P
GSX-R 1300 HAYABUSA (Tokico Front std caliper)	1300		2008 → 2012	FDB2178	2	ZRAC/XRAC/ST	FDB2213		ST/P
GSX-R 1300 HAYABUSA ABS (Brembo Caliper-Road pad)	1300		2013 →	FDB2260	2	XRAC/ST/CPRO	FDB2213		ST/P
B-KING	1340		2010 →	FDB2158	2	ST	FDB2213		ST/P
GSX 1400	1400		2002 →	FDB873	2	ZRAC/XRAC/ST/P/EF/CPRO/CP1	FDB2111		ST/P/EF
GV 1400	1400		1985 → 1986	FDB389	2	ST/P	FDB313		SG/P/EF
GV 1400 GD	1400		1985 → 1986	FDB389	2	ST/P	FDB389		ST/P
GV 1400 CAVALCADE	1400		1987 → 1988	FDB569	2	ST/P			
VS 1400 Intruder (VX51L)	1400		1987 → 1995	FDB389		ST/P	FDB389		ST/P
VS 1400 GLP Intruder (VX51L/T)	1400		1996 → 2003	FDB389		ST/P	FDB389		ST/P
INTRUDER C1500	1500		2005 → 2009	FDB2048		left XRAC/ST/P/EF/CP1			
INTRUDER C1500	1500		2005 → 2009	FDB2049		right XRAC/ST/P/EF/CP1			
INTRUDER C1500	1500		2005 → 2009				FDB2163		ST
INTRUDER C1500 BT-T	1500		2013 →	FDB570		XRAC/ST/SM/P/EF/CPRO	FDB2049		XRAC/ST/P/EF/CP1
M1500 INTRUDER	1500		2008 →	FDB2049		XRAC/ST/P/EF/CP1	FDB2049		XRAC/ST/P/EF/CP1
VL 1500	1500		1998 → 2001	FDB389	2	ST/P	FDB389		ST/P
VL 1500 K2	1500		2002 → 2003	FDB2048		left XRAC/ST/P/EF/CP1			
VL 1500 K2	1500		2002 → 2003	FDB2049		right XRAC/ST/P/EF/CP1			
VL 1500 K2	1500		2002 → 2003				FDB2163		ST
VZ 1600 MARAUDER	1600		2004 →	FDB873	2	ZRAC/XRAC/ST/P/EF/CPRO/CP1	FDB2049		XRAC/ST/P/EF/CP1
M 1800 R INTRUDER (VRZ)	1800		2006 → 2009	FDB2178	2	ZRAC/XRAC/ST	FDB2049		XRAC/ST/P/EF/CP1

* It is recommended that in those applications where sintered pads are supplied as Original Equipment, replacement pads should also be of sintered composition.

** To avoid brake imbalance sintered pads fitted in rear calipers should only be used in combination with front calipers containing sintered pads.



	CC	KW	FROM -> TO		N° SET	L/R	COMPOUND		N° SET	L/R	COMPOUND
...SUZUKI											
M 1800 RZ INTRUDER (VRZ)	1800		2007 → 2013	FDB2178	2		ZRAC/XRAC/ST	FDB2049			XRAC/ST/P/EF/CP1
M 1800 R2 INTRUDER (VRZ)	1800		2008 → 2009	FDB2178	2		ZRAC/XRAC/ST	FDB2049			XRAC/ST/P/EF/CP1
M 1800 RB INTRUDER (VZR)	1800		2014 →	FDB2178	2		ZRAC/XRAC/ST	FDB2049			XRAC/ST/P/EF/CP1
VLR 1800 INTRUDER C1800 R/RT	1800		2008 →	FDB2196	2		ST/SM/P/EF	FDB2049			XRAC/ST/P/EF/CP1
SWM											
GS 50 RBS ENDURO	50		1983 →	FSB898				FSB898			
MC 50 CROSS	50		1983 →	FSB898				FSB898			
MK 50	50		1983 →	FSB898				FSB898			
TR 50	50		→ 1983	FSB907				FSB907			
TL 50 TRIAL	50		→ 1983	FSB907				FSB907			
GS 80 RBS ENDURO	80		1983 →	FSB898				FSB898			
MC 80 CROSS	80		1983 →	FSB898				FSB898			
MK 80	80		1983 →	FSB898				FSB898			
TR 80	80		→ 1983	FSB907				FSB907			
TL 80 TRIAL	80		→ 1983	FSB907				FSB907			
CROSS 125	125		→ 1983	FSB901				FSB901			
ENDURO 125	125		→ 1983	FSB901				FSB901			
HW 125	125		→ 1983	FSB898				FSB898			
MW 125 TRIAL	125		→ 1983	FSB898				FSB898			
S1 125	125		1983 →	FDB207			ST/P/EF/CP1				
S2 125	125		1983 →	FDB207			ST/P/EF/CP1				
TL 125	125		→ 1983	FSB898				FSB898			
ENDURO 175	175		→ 1983	FSB901				FSB901			
HW 240	240		→ 1983	FSB898				FSB898			
MW 240 TRIAL	240		→ 1983	FSB898				FSB898			
TL 240	240		→ 1983	FSB898				FSB898			
TRIAL 240	240		→ 1983	FSB898				FSB898			
CROSS 250	250		→ 1983	FSB901				FSB901			
S1 250	250		1983 →	FDB207			ST/P/EF/CP1				
S2 250	250		1983 →	FDB207			ST/P/EF/CP1				
RS 300 R (4T)	300		2015 →	FDB2018			ZR/ST/SG/P/EF	FDB2165			SG/P/EF
HW 320	320		→ 1983	FSB898				FSB898			
MW 320 TRIAL	320		→ 1983	FSB898				FSB898			
TL 320	320		→ 1983	FSB898				FSB898			
TRIAL 320	320		→ 1983	FSB898				FSB898			
ENDURO 347	347		→ 1983	FSB901				FSB901			
HW 350	350		→ 1983	FSB898				FSB898			
MW 350 TRIAL	350		→ 1983	FSB898				FSB898			
TL 350	350		→ 1983	FSB898				FSB898			
XP 350 SAHARA	350		1983 →	FDB108			ST/P/EF/CPRO				
CROSS 440	440		→ 1983	FSB901				FSB901			
ENDURO 440	440		→ 1983	FSB901				FSB901			
Gran Milano	440		2015 →	FDB570			XRAC/ST/SM/P/EF/CPRO				
Silver Vase	440		2015 →	FDB570			XRAC/ST/SM/P/EF/CPRO				
RS 500 R	500		2015 →	FDB2018			ZR/ST/SG/P/EF	FDB2165			SG/P/EF
SM 500 R	500		2015 →	FDB2120			ZRAC/XRAC/ST	FDB2165			SG/P/EF
Super Dual	650		2015 →	FDB2120			ZRAC/XRAC/ST	FDB2005			ST/SG/P/EF
SYM											
E Woo - Electric			2011 →	FDB2192			AG	FSB704			
E-Symmetry(Electric)			2012 → 2013	FDB2192			AG	FSB704			
E-Virid(Electric)			2012 →	FSB704				FSB704			
E-ViridDeluxe (Electric)			2012 →	FDB2192			AG	FSB704			
Evie (Electric Scooter)			2010 →	FSB704				FSB704			
Symmetry - Electric			2011 →	FSB704				FSB704			
Allo 50 (4T)	50		2011 →	FDB2190			EF	FSB960			
Allo GT 50 (4T)	50		2013 →	FDB2190			EF	FSB960			
BULLET 50	50		1993 →	FDB2192			AG				
CITY HOPPER 50	50		1999 → 2002	FDB625			EF	FSB704			
Crox 50	50		2014 →	FDB2190			EF				
DD 50 CITY TREK	50		2002 →	FDB625			EF	FSB704			
FEEL BIG 50	50		1998 → 2002	FDB2192			AG				
FIDDLE 50	50		1999 →	FSB704				FSB704			
Fiddle II 50	50		2008 →	FDB2190			EF	FSB704			
Fiddle III 50 (4T)	50		2014 →	FDB2190			EF	FSB704			
JET 50	50		1999 →	FDB2190			EF	FSB704			
Jet Basix 50	50		2006 → 2009	FDB2190			EF	FSB704			
Jet Euro X 50	50		2006 → 2012	FDB2190			EF	FSB704			
Jet Sport X 50	50		2006 → 2013	FDB2190			EF	FDB2101			AG

* It is recommended that in those applications where sintered pads are supplied as Original Equipment, replacement pads should also be of sintered composition.

** To avoid brake imbalance sintered pads fitted in rear calipers should only be used in combination with front calipers containing sintered pads.



CC KW FROM -> TO N° SET L/R COMPOUND N° SET L/R COMPOUND

...SYM

Jet Sport X 50 S	50		2006	→	2013	FDB2190			EF	FDB2101			AG
Jet Sport X 50 SR	50		2006	→	2013	FDB2190			EF	FDB2101			AG
Jet 4 (50cc- 4T)	50		2010	→		FDB2190			EF	FSB704			
Jet 4 R (50cc- 2T)	50		2011	→		FDB2190			EF	FSB704			
Jet Evo 50 (2T)	50		2013	→		FDB2190			EF	FSB704			
Jet4 Naked (50cc/4T)	50		2013	→		FDB2190			EF	FSB704			
JUNGLE 50	50		1999	→	2002	FDB2190			EF	FSB704			
MASK 50	50		2000	→		FDB2190			EF	FSB704			
Mio 50	50		2005	→	2013	FDB2192			AG	FSB704			
Orbit 50	50		2008	→	2009	FDB625			EF	FSB704			
Orbit II 50 (4T)	50		2012	→		FDB2190			EF	FSB966			
Orbit II 50 Naked (4T)	50		2012	→		FDB2190			EF	FSB966			
Orbit II 50 TS (4T)	50		2012	→		FDB2190			EF	FSB704			
PURE 50	50		1998	→	2002	FDB2192			AG				
RED DEVIL 50	50		1999	→		FDB2190			EF	FSB704			
RS 50	50		2004	→		FDB2108			EF				
SHARK 50	50		1999	→	2003	FDB2108			EF	FSB960			
SUPER FANCY 50	50		1996	→	2002	FDB625			EF	FSB704			
SUPER FANCY 50 (G5H-6/H325)	50		1996	→	2002	FDB2190			EF	FSB704			
Symphony 50 (4T/Rear drum model)	50		2009	→		FDB2190			EF	FSB964			
Symphony 50 SR (4T/Rear disc model)	50		2010	→		FDB2190			EF	FDB2057			EF/AG
Symphony S 50 (4T/Rear disc model)	50		2010	→		FDB2190			EF	FDB2057			EF/AG
Symphony 50 ST	50		2015	→		FDB2190			EF	FDB2057			EF/AG
Symply 50	50		2007	→	2008	FDB2190			EF	FSB704			
Symply II 50	50		2009	→		FDB2190			EF	FSB704			
Tonic 50	50		2011	→		FDB2192			AG	FSB704			
X'Pro 50	50		2013	→		FDB2087			EF	FSB704			
CINDERELLA 50 / 100	100		1999	→	2000	FDB625			EF	FSB704			
JET 100	100		1999	→		FDB2190			EF	FSB704			
Mio 100	100		2005	→	2014	FDB2192			AG	FSB704			
Mio 100	100		2015	→						FSB704			
SR 100 SUNRISE	100		1998	→		FDB539			SG/P/EF				
Symba 100	100		2011	→	2012	FSB704				FSB704			
Mio 110i	110		2005	→	2015	FDB2192			AG				
Tonic 110 (4T)	110		2011	→	2013	FDB2192			AG	FSB966			
Mio 115 CBS	115		2017	→	2018	FDB2108			EF	FSB704			
Allo 125 (4T)	125		2011	→		FDB2190			EF	FSB960			
ATTILA 125	125		1999	→	2000	FDB2190			EF	FSB960			
Cevalo B9A (125cc -4T)	125		2010	→	2010	FDB570			XRAC/ST/SM/P/EF/CPRO				
City Com 125	125		2008	→	2013	FDB2190			EF	FDB2226			EF/AG
ComBiz 125	125		2011	→		FDB2096			SG/EF	FSB733			
Crox 125 i	125		2014	→		FDB2190			EF				
Fiddle II 125	125	6	2009	→	2013	FDB2190			EF	FSB964			
Fiddle III 125 (4T)	125	7	2014	→		FDB2190			EF	FSB964			
GTS 125	125		2006	→	2009	FDB2226			EF/AG	FDB2226			EF/AG
GTS 125 i	125		2010	→	2015	FDB2141	2		SG/EF	FDB2226			EF/AG
Joymax 125 i GTS Sport	125		2016	→		FDB2085			ST/SM/P/EF	FDB2226			EF/AG
HD Evo 125 (Carb & EFi Models/4T/Single Headlight)	125		2003	→		FDB2190			EF	FDB2226			EF/AG
HD 125	125		2004	→	2007	FDB2096			SG/EF	FSB960			
HD 125 S Evo	125		2007	→		FDB2190			EF	FSB960			
HD2- 125i (4T)	125		2010	→		FDB2190			EF	FDB2226			EF/AG
HUSKY 125	125		2000	→		FDB2129			SG	FSB959			
JET 4 (125cc- 4T)	125	7	2009	→		FDB2190			EF	FSB964			
JETV (125cc/4T)	125		2012	→	2013	FDB2096			SG/EF	FSB966			
Jet 14 125 i	125		2017	→		FDB2190			EF	FDB2190			EF
JOYRIDE 125	125		2001	→	2005	FDB2108			EF	FDB2096			SG/EF
JOYRIDE (Euro2 - Euro3)	125		2005	→	2006	FDB2108			EF	FDB2226			EF/AG
JOYRIDE 125 EURO2	125		2005	→	2006	FDB2108			EF	FDB2226			EF/AG
Joyride 125 i	125		2007	→	2009	FDB2108			EF	FDB2226			EF/AG
Joyride EVO 125 i (Twin Headlights)	125		2009	→		FDB2108			EF	FDB2226			EF/AG
Joyride S 125i	125		2016	→		FDB2108			EF	FDB2226			EF/AG
MEGALO 125	125		2000	→		FDB2190			EF	FSB960			
EURO MX 125	125		2002	→		FDB2108			EF	FSB960			
Euro MX 125 (HF12W3-6 Euro 2) (Rear disc model)	125		2006	→	2009	FDB2108			EF	FDB2087			EF
Orbit 125	125		2008	→	2009	FDB625			EF	FSB960			
Orbit II/Symply 125 (4T)	125		2009	→		FDB2190			EF	FSB704			
Orbit II / Simply II 125 i	125		2012	→	2015	FDB2190			EF				
RS 125	125		2001	→		FDB2108			EF				
SB 125 Ni - Wolf (EFi Model)	125		2011	→		FDB2226			EF/AG	FDB2184			SG/P
SB125 N - Wolf (Carb Model/Drum Rear Brake)	125		2011	→		FDB781			ST/P/EF				
SHARK 125	125		1999	→	2002	FDB2108			EF	FSB966			
SHARK 4 VR 125	125		2000	→	2002	FDB2108			EF	FDB2087			EF
SUPER DUKE 125 / 150	125		1999	→	2000	FDB2190			EF	FSB704			
Symphony 125 (4T/Rear drum) (AY12W)	125	7	2009	→		FDB2190			EF	FSB964			

* It is recommended that in those applications where sintered pads are supplied as Original Equipment, replacement pads should also be of sintered composition.

** To avoid brake imbalance sintered pads fitted in rear calipers should only be used in combination with front calipers containing sintered pads.



CC KW FROM -> TO N° SET L/R COMPOUND N° SET L/R COMPOUND

...SYM

Symphony 125 SR (4T/Rear disc model)	125		2010 →	FDB2190			EF	FDB2057		EF/AG
Symphony 125 S (4T/Rear disc model) (AY12W7)	125	7	2010 →	FDB2190			EF	FDB2057		EF/AG
Symphony 125 ST	125		2015 →	FDB2190			EF	FDB2057		EF/AG
Symphony Cargo 125 i	125		2015 →	FDB2190			EF	FDB2057		EF/AG
Symply 125	125		2007 → 2008	FDB2190			EF	FSB964		
Symply II 125	125		2009 →	FDB2190			EF	FSB964		
Tonic 125	125		2011 →	FDB2192			AG	FSB960		
VS 125	125		2006 →	FDB2108			EF	FSB960		
X Pro 125	125		2013 →	FDB2190			EF	FSB964		
XS 125 K	125		2007 →	FDB2087			EF	FSB706		
Allo 150 (4T)	150		2011 →	FDB2190			EF	FSB960		
Fighter VI	150		2010 → 2015	FDB2190			EF	FDB2312		EF
HUSKY 150	150		2000 →	FDB2129			SG	FSB959		
Jet4 (150cc/4T)	150		2013 →	FDB2190			EF	FSB960		
JOYRIDE 150	150		2001 →	FDB2108			EF	FDB2096		SG/EF
EURO MX 150	150		2002 →	FDB2108			EF	FSB960		
RS 150	150		2001 →	FDB2108			EF			
RS 150	150		2006 →	FDB2108			EF	FDB497		ST/SM/SG/P/EF
SHARK 150	150		1999 → 2002	FDB2108			EF	FSB966		
SHARK 4 VR 150	150		2000 → 2002	FDB2108			EF	FDB2087		EF
SUPER DUKE 150	150		1999 →	FDB2190			EF	FSB960		
VS 150	150		2006 →	FDB2108			EF	FSB960		
Fiddle II 151	151		2010 →	FDB2190			EF	FSB964		
Symphony 151 SR (4T/Rear disc model)	151		2010 →	FDB2190			EF	FDB2057		EF/AG
Symphony S 151 (4T/Rear disc model)	151		2010 →	FDB2190			EF	FDB2057		EF/AG
Fiddle III 200i (4T)	200		2014 →	FDB2190			EF	FDB2057		EF/AG
HD 200	200		2004 → 2005	FDB2096			SG/EF	FSB960		
HD 200 EVO Euro 2-3 / EVO 1 Euro 2-3	200		2005 → 2006	FDB2190			EF	FDB2226		EF/AG
HD200 S Evo	200		2007 →	FDB2190			EF	FDB2226		EF/AG
HD2-200i (Twin H/Lights/4T)	200		2010 →	FDB2190			EF	FDB2226		EF/AG
Jet 14 200 i	200		2018 →	FDB2190			EF			
JOYRIDE 200	200		2001 →	FDB2108			EF	FDB2096		SG/EF
Joyride 200 i	200		2007 → 2009	FDB2108			EF	FDB2226		EF/AG
Joyride EVO 200 i	200		2009 →	FDB2108			EF	FDB2226		EF/AG
Joyride S. 200i	200		2016 →	FDB2108			EF	FDB2226		EF/AG
Symphony 200ST	200		2015 → 2018	FDB2190			EF	FDB2057		EF/AG
GTS 250	250		2007 → 2008	FDB2141	2		SG/EF	FDB2226		EF/AG
Joymax 250 i GTS (All Models)	250		2009 → 2015	FDB2141	2		SG/EF	FDB2226		EF/AG
Joymax 250 i GTS Sport	250		2016 →	FDB2085			ST/SM/P/EF	FDB2226		EF/AG
JOYMAX 250	250		2006 → 2007	FDB2141	2		SG/EF	FDB2226		EF/AG
Joymax 250 i	250		2007 → 2008	FDB2141	2		SG/EF	FDB2226		EF/AG
SB250 Ni - Wolf	250		2012 →	FDB2291			EF	FDB2184		SG/P
Voyager 250	250		2005 → 2005	FDB2141	2		SG/EF	FDB2126		SM/P/EF
City Com 300 i	300		2008 →	FDB2190			EF	FDB2190		EF
City Com 300 i S	300		2015 →	FDB2190			EF	FDB2190		EF
Cruisym 300 i	300		2017 →	FDB2291			EF	FDB2226		EF/AG
Joymax 300 GTS (All Models)	300		2008 → 2015	FDB2141	2		SG/EF	FDB2226		EF/AG
Joymax 300 i GTS Sport	300		2016 →	FDB2085			ST/SM/P/EF	FDB2226		EF/AG
SB300 Cafe' Racer	300		2016 →					FDB2184		SG/P
WOLF 300 Classic	300		2015 →	FDB2291			EF			
Wolf 300 i Cafe' Racer	300		2015 →	FDB2291			EF	FDB2184		SG/P
Max Sym 400i	400		2011 →	FDB2291			EF	FDB2292		EF
GT 500	500		2004 →	FDB2085			ST/SM/P/EF			
Max Sym 600i (ABS)	600		2014 →	FDB2291			EF	FDB2292		EF

TGB

101R (50cc)	50		2004 → 2009	FDB2190			EF	FSB883		
202 Classic (50cc)	50		2003 →	FDB2190			EF	FSB883		
203 TRIGGER 50	50		2002 →	FDB313			SG/P/EF			
302Sport (50cc)	50		2003 → 2009	FDB384			P	FSB883		
303Revolution (50cc)	50		2002 → 2003	FDB313			SG/P/EF	FSB883		
303RHawk/Laser (50cc)	50		2004 →	FDB313			SG/P/EF	FSB883		
309RS 50	50		2002 → 2003	FDB384			P	FSB883		
F409Cruise 50/125	50		2002 → 2005	FDB313			SG/P/EF	FSB883		
AkrosTec -50	50		2003 → 2004	FDB2190			EF	FSB883		
R50 X Bullet	50		2006 → 2010	FDB384			P	FDB313		SG/P/EF
R50 X Bullet	50		2010 →	FDB384			P	FDB313		SG/P/EF
Bullet 2 50 (2T)	50		2011 → 2012	FDB313			SG/P/EF	FSB883		
Bullet 50 RR (2T)	50		2011 → 2012	FDB313			SG/P/EF	FDB313		SG/P/EF
Bullet 50 RS (2T)	50		2011 → 2012	FDB313			SG/P/EF	FDB313		SG/P/EF
City50cc (2T)	50		2007 → 2008	FDB313			SG/P/EF	FSB883		
City50cc (4T)	50		2007 → 2011	FDB313			SG/P/EF	FSB883		

* It is recommended that in those applications where sintered pads are supplied as Original Equipment, replacement pads should also be of sintered composition.

** To avoid brake imbalance sintered pads fitted in rear calipers should only be used in combination with front calipers containing sintered pads.



CC KW FROM -> TO



N° SET L/R COMPOUND



N° SET L/R COMPOUND

...TGB

Delivery50 Scooter (Up to E/F no 609099)	50	2004	→	2006	FDB2190			EF	FSB883			
Delivery/Express50 (From F/E No 609100)	50	2006	→	2012	FDB313			SG/P/EF	FSB883			
HighWheel 50	50	2002	→	2003	FDB313			SG/P/EF	FSB883			
TapoRR 50 (2T)	50	2010	→	2012	FDB313			SG/P/EF	FSB883			
TapoRS 50 (2T)	50	2010	→	2012	FDB313			SG/P/EF	FSB883			
Trigger50	50	2002	→	2003	FDB313			SG/P/EF	FSB883			
XRace 50 (2T)	50	2011	→	2012	FDB313			SG/P/EF	FSB883			
204Classic (125cc)	125	2003	→	2004	FDB313			SG/P/EF				
303Revolution (125cc)	125	2002	→	2003	FDB313			SG/P/EF	FSB883			
303RHawk/Laser (125cc)	125	2004	→	2008	FDB384			P	FSB960			
303RHawk/Laser (125cc)	125	2009	→		FDB384			P	FSB960			
304Sport (125cc)	125	2003	→	2009	FDB384			P	FSB883			
F409Cruise 125	125	2002	→	2005	FDB313			SG/P/EF	FSB883			
Bellavita125 i (4T)	125	2012	→		FDB2190			EF	FDB2090			P/EF
R125 X Bullet	125	2008	→	2009	FDB384			P	FDB313			SG/P/EF
R125 X Bullet	125	2010	→		FDB384			P	FDB313			SG/P/EF
Delivery/Express(125cc)	125	2004	→		FDB384			P	FSB960			
X-Motion125	125	2008	→						FDB2226			EF/AG
X-Motion125 R i	125	2011	→	2012					FDB2226			EF/AG
303RHawk/Laser (150cc)	150	2004	→	2008	FDB384			P	FSB960			
303RHawk/Laser (150cc)	150	2009	→		FDB384			P	FSB960			
X-Motion250i	250	2008	→	2010					FDB2226			EF/AG
Bellavita300 i (4T)	300	2012	→		FDB2190			EF	FDB2090			P/EF
X-Motion300 Efi	300	2010	→	2012					FDB2226			EF/AG
404Executive	404	2003	→	2004	FDB384			P				

TM

all models 80	80	1990	→	1993	FDB499			P	FDB314			ST/SG/P/EF
80 (Big wheel)	80	2002	→	2004	FDB2018			ZR/ST/SG/P/EF	FDB2005			ST/SG/P/EF
80 Cross	80	1996	→	2001	FDB2018			ZR/ST/SG/P/EF	FDB2005			ST/SG/P/EF
80 Enduro	80	1996	→	2000	FDB2018			ZR/ST/SG/P/EF	FDB2005			ST/SG/P/EF
GS 80	80	1986	→	1989	FDB499			P	FDB207			ST/P/EF/CP1
80 Minicross/Junior	80	1996	→	2000	FDB313			SG/P/EF	FDB661			SG/P
80 Junior Cross (Small wheel)	80	2002	→	2004	FDB2018			ZR/ST/SG/P/EF	FDB2005			ST/SG/P/EF
80 Junior	80	2005	→	2007	FDB2018			ZR/ST/SG/P/EF	FDB2162			SG/P/EF
MC 80	80	1986	→	1989	FDB499			P	FDB207			ST/P/EF/CP1
85 (Big wheel)	85	2002	→	2004	FDB2018			ZR/ST/SG/P/EF	FDB2005			ST/SG/P/EF
85 Cross	85	1996	→	2001	FDB2018			ZR/ST/SG/P/EF	FDB2005			ST/SG/P/EF
85 Minicross/Junior	85	1996	→	2000	FDB313			SG/P/EF	FDB661			SG/P
85 Junior Cross (Small wheel)	85	2002	→	2004	FDB2018			ZR/ST/SG/P/EF	FDB2005			ST/SG/P/EF
85 Junior	85	2005	→	2007	FDB2018			ZR/ST/SG/P/EF	FDB2162			SG/P/EF
MX 85 (Big Wheel)	85	2002	→	2004	FDB2018			ZR/ST/SG/P/EF	FDB539			SG/P/EF
MX 85 JR (Small Wheel)	85	2002	→	2004	FDB2018			ZR/ST/SG/P/EF	FDB539			SG/P/EF
MX 85 (Big Wheel)	85	2005	→		FDB2018			ZR/ST/SG/P/EF	FDB2162			SG/P/EF
MX 85 JR (Small Wheel)	85	2005	→		FDB2018			ZR/ST/SG/P/EF	FDB2162			SG/P/EF
100 (Big wheel)	100	2002	→	2004	FDB2018			ZR/ST/SG/P/EF	FDB2005			ST/SG/P/EF
100 Junior Cross (Small wheel)	100	2002	→	2004	FDB2018			ZR/ST/SG/P/EF	FDB2005			ST/SG/P/EF
100 Junior	100	2005	→	2007	FDB2018			ZR/ST/SG/P/EF	FDB2162			SG/P/EF
125 Cross	125	1995	→	2000	FDB2018			ZR/ST/SG/P/EF	FDB2005			ST/SG/P/EF
Enduro EN 125 (2T)	125	2001	→	2004	FDB2018			ZR/ST/SG/P/EF	FDB539			SG/P/EF
Enduro EN 125 (2T)	125	2005	→		FDB2018			ZR/ST/SG/P/EF	FDB539			SG/P/EF
Enduro EN 125 (2T) - USA VERSION	125	2005	→	2008	FDB2018			ZR/ST/SG/P/EF	FDB2162			SG/P/EF
125 Enduro	125	1995	→	2000	FDB2018			ZR/ST/SG/P/EF	FDB2005			ST/SG/P/EF
GS 125	125	1986	→	1989	FDB499			P	FDB207			ST/P/EF/CP1
GS / MC 125	125	1990	→	1993	FDB499			P	FDB314			ST/SG/P/EF
MC 125	125	1986	→	1989	FDB499			P	FDB207			ST/P/EF/CP1
MX 125 (2T)	125		→	2004	FDB2018			ZR/ST/SG/P/EF	FDB539			SG/P/EF
MX 125 (2T)	125	2005	→		FDB2018			ZR/ST/SG/P/EF	FDB2162			SG/P/EF
SMM 125 Black Dream (Rim front disc)	125	2004	→	2007					FDB207			ST/P/EF/CP1
SMM 125 (2T) Black Dream (320mm front disc)	125	2008	→	2012	FDB2120			ZRAC/XRAC/ST	FDB207			ST/P/EF/CP1
SMR 125 (2T)	125	2005	→	2014	FRP408			XRAC/ST/PRP/P/CP/PRO/CP1	FDB2162			SG/P/EF
SMR 125 (2T)	125	2015	→		FDB2120			ZRAC/XRAC/ST	FDB2162			SG/P/EF
SMX 125 (2T)	125	2015	→		FDB2120			ZRAC/XRAC/ST	FDB2162			SG/P/EF
EN 144 (2T)	144	2008	→		FDB2018			ZR/ST/SG/P/EF	FDB2162			SG/P/EF
MX 144 (2T)	144	2008	→		FDB2018			ZR/ST/SG/P/EF	FDB2162			SG/P/EF
250 Cross	250	1995	→	2000	FDB2018			ZR/ST/SG/P/EF	FDB2005			ST/SG/P/EF
Enduro EN 250 (2T)	250	2001	→	2004	FDB2018			ZR/ST/SG/P/EF	FDB539			SG/P/EF
EN 250 Fi (4T) Enduro	250	2005	→		FDB2018			ZR/ST/SG/P/EF	FDB2162			SG/P/EF
Enduro EN 250 (2T)	250	2005	→		FDB2018			ZR/ST/SG/P/EF	FDB2162			SG/P/EF
EN 250 Fi ES	250	2015	→		FDB2018			ZR/ST/SG/P/EF	FDB2162			SG/P/EF
250 Enduro	250	1995	→	2000	FDB2018			ZR/ST/SG/P/EF	FDB2005			ST/SG/P/EF
MX 250 (2T)	250	2001	→	2004	FDB2018			ZR/ST/SG/P/EF	FDB539			SG/P/EF

* It is recommended that in those applications where sintered pads are supplied as Original Equipment, replacement pads should also be of sintered composition.

** To avoid brake imbalance sintered pads fitted in rear calipers should only be used in combination with front calipers containing sintered pads.

1096



CC KW FROM -> TO N° SET L/R COMPOUND N° SET L/R COMPOUND

...TM											
MX 250 (4T) Cross	250	2002	→ 2004	FDB2018			ZR/ST/SG/P/EF	FDB539			SG/P/EF
MX 250 (2T)	250	2005	→	FDB2018			ZR/ST/SG/P/EF	FDB2162			SG/P/EF
MX 250 (4T) Cross	250	2005	→ 2012	FDB2018			ZR/ST/SG/P/EF	FDB2162			SG/P/EF
MX 250 Fi (4T)	250	2010	→	FDB2018			ZR/ST/SG/P/EF	FDB2162			SG/P/EF
SM 250	250	2002	→	FRP408			XRAC/ST/PRP/P/CPRO/CP1	FDB539			SG/P/EF
SME 250 (4T)	250	2004	→	FRP408			XRAC/ST/PRP/P/CPRO/CP1	FDB539			SG/P/EF
SMM 250 (2T)	250	2005	→ 2014	FRP408			XRAC/ST/PRP/P/CPRO/CP1	FDB207			ST/P/EF/CP1
SMM 250 Fi (4T)	250	2010	→	FDB2120			ZRAC/XRAC/ST	FDB2162			SG/P/EF
SMM 250 (2T)	250	2015	→	FDB2120			ZRAC/XRAC/ST	FDB207			ST/P/EF/CP1
SMR 250 (2T)	250	2005	→ 2014	FRP408			XRAC/ST/PRP/P/CPRO/CP1	FDB2162			SG/P/EF
SMR 250 Fi (4T)	250	2010	→	FDB2120			ZRAC/XRAC/ST	FDB2162			SG/P/EF
SMR 250 (2T)	250	2015	→	FDB2120			ZRAC/XRAC/ST	FDB2162			SG/P/EF
SMX 250 Fi (4T)	250	2012	→	FDB2120			ZRAC/XRAC/ST	FDB2162			SG/P/EF
SMX 250 (2T)	250	2015	→	FDB2120			ZRAC/XRAC/ST	FDB2162			SG/P/EF
300 Cross	300	1995	→ 2000	FDB2018			ZR/ST/SG/P/EF	FDB2005			ST/SG/P/EF
Enduro EN 300 (2T)	300	2001	→ 2004	FDB2018			ZR/ST/SG/P/EF	FDB539			SG/P/EF
Enduro EN 300 (2T)	300	2005	→	FDB2018			ZR/ST/SG/P/EF	FDB2162			SG/P/EF
EN 300 Fi (4T)	300	2017	→	FDB2018			ZR/ST/SG/P/EF	FDB2162			SG/P/EF
300 Enduro (2T)	300	1995	→ 2000	FDB2018			ZR/ST/SG/P/EF	FDB2005			ST/SG/P/EF
MX 300 (2T)	300	2001	→ 2004	FDB2018			ZR/ST/SG/P/EF	FDB539			SG/P/EF
MX 300 (2T)	300	2005	→	FDB2018			ZR/ST/SG/P/EF	FDB2162			SG/P/EF
MX 300 Fi (4T)	300	2017	→	FDB2018			ZR/ST/SG/P/EF	FDB2162			SG/P/EF
SMM 300 (2T)	300	2005	→ 2014	FRP408			XRAC/ST/PRP/P/CPRO/CP1	FDB207			ST/P/EF/CP1
SMM 300 (2T)	300	2015	→	FDB2120			ZRAC/XRAC/ST	FDB207			ST/P/EF/CP1
SMR 300 (2T)	300	2005	→ 2014	FRP408			XRAC/ST/PRP/P/CPRO/CP1	FDB2162			SG/P/EF
SMR 300 (2T)	300	2015	→	FDB2120			ZRAC/XRAC/ST	FDB2162			SG/P/EF
SMX 300 (2T)	300	2015	→	FDB2120			ZRAC/XRAC/ST	FDB2162			SG/P/EF
400 Cross (4T)	400	1995	→ 2000	FDB2018			ZR/ST/SG/P/EF	FDB2005			ST/SG/P/EF
400 (4T) MX Cross	400	2002	→ 2003	FDB2018			ZR/ST/SG/P/EF	FDB539			SG/P/EF
SM 400	400	2002	→ 2003	FRP408			XRAC/ST/PRP/P/CPRO/CP1	FDB539			SG/P/EF
SME 400 (4T)	400	2004	→	FRP408			XRAC/ST/PRP/P/CPRO/CP1	FDB539			SG/P/EF
SMM 400 (4T) (Rim brake)	400	2004	→ 2004					FDB207			ST/P/EF/CP1
EN 450 F (4T)	450		→ 2004	FDB2018			ZR/ST/SG/P/EF	FDB539			SG/P/EF
EN 450 Fi (4T)	450	2005	→	FDB2018			ZR/ST/SG/P/EF	FDB2162			SG/P/EF
EN 450 Fi ES	450	2015	→	FDB2018			ZR/ST/SG/P/EF	FDB2162			SG/P/EF
FLAT TRACK 450 Fi	450	2016	→	FDB2018			ZR/ST/SG/P/EF	FDB2162			SG/P/EF
MX 450 F (4T)	450		→ 2004	FDB2018			ZR/ST/SG/P/EF	FDB539			SG/P/EF
MX 450 F - USA versiom	450	2005	→ 2008	FDB2018			ZR/ST/SG/P/EF	FDB539			SG/P/EF
MX 450 Fi (4T)	450	2005	→	FDB2018			ZR/ST/SG/P/EF	FDB2162			SG/P/EF
SMM 450 F Black Dream ES (320mm front disc)	450	2008	→ 2010	FDB2120			ZRAC/XRAC/ST	FDB207			ST/P/EF/CP1
SMM 450 Fi (4T)	450	2011	→	FDB2120			ZRAC/XRAC/ST	FDB207			ST/P/EF/CP1
SMR 450 FES	450	2005	→ 2009	FRP408			XRAC/ST/PRP/P/CPRO/CP1	FDB2162			SG/P/EF
SMR 450 Fi (4T)	450	2010	→	FDB2120			ZRAC/XRAC/ST	FDB2162			SG/P/EF
SMX 450 F Competition (4T)	450	2005	→ 2008	FDB2120			ZRAC/XRAC/ST	FDB539			SG/P/EF
SMX 450 Fi (4T)	450	2005	→	FDB2120			ZRAC/XRAC/ST	FDB2162			SG/P/EF
530 Cross (4T)	530	1998	→ 2000	FDB2018			ZR/ST/SG/P/EF	FDB2005			ST/SG/P/EF
530 (4T) Cross	530	2002	→ 2003	FRP408			XRAC/ST/PRP/P/CPRO/CP1	FDB539			SG/P/EF
EN 530 F (4T)	530		→ 2004	FDB2018			ZR/ST/SG/P/EF	FDB539			SG/P/EF
EN 530 Fi (4T)	530	2005	→	FDB2018			ZR/ST/SG/P/EF	FDB2162			SG/P/EF
MX 530 F	530		→ 2004	FDB2018			ZR/ST/SG/P/EF	FDB539			SG/P/EF
MX 530 F	530	2005	→	FDB2018			ZR/ST/SG/P/EF	FDB2162			SG/P/EF
MX 530 Fi (4T)	530	2016	→	FDB2018			ZR/ST/SG/P/EF	FDB2162			SG/P/EF
SM 530	530	2002	→ 2003	FRP408			XRAC/ST/PRP/P/CPRO/CP1	FDB539			SG/P/EF
SME 530 (4T)	530	2004	→	FRP408			XRAC/ST/PRP/P/CPRO/CP1	FDB539			SG/P/EF
SMM 530 F Black Dream (Rim brake)	530	2004	→ 2007					FDB207			ST/P/EF/CP1
SMM 530 F Black Dream ES (320mm front disc)	530	2008	→ 2010	FDB2120			ZRAC/XRAC/ST	FDB207			ST/P/EF/CP1
SMM 530 Fi (4T)	530	2016	→	FDB2120			ZRAC/XRAC/ST	FDB207			ST/P/EF/CP1
SMR 530 F ES	530	2005	→ 2009	FRP408			XRAC/ST/PRP/P/CPRO/CP1	FDB2162			SG/P/EF
SMR 530 Fi (4T)	530	2010	→	FDB2120			ZRAC/XRAC/ST	FDB2162			SG/P/EF
SMR 530 Fi ES	530	2015	→	FDB2120			ZRAC/XRAC/ST	FDB207			ST/P/EF/CP1
SMX 530 Fi (T)	530	2005	→	FDB2120			ZRAC/XRAC/ST	FDB2162			SG/P/EF
SMX 660 F	660		→ 2004	FRP408			XRAC/ST/PRP/P/CPRO/CP1	FDB539			SG/P/EF
SMX 660 F	660	2005	→ 2010	FDB2120			ZRAC/XRAC/ST	FDB2162			SG/P/EF
TOMOS											
N 50 AT BT	50	1991	→ 2000	FDB436			P				
REVIVAL	50	2003	→	FDB697			EF				
STREETMATE	50	2003	→	FDB697			EF				
K 83	83		→	FSB902				FSB902			
M 83	83		→	FSB902				FSB902			

TORNAX

* It is recommended that in those applications where sintered pads are supplied as Original Equipment, replacement pads should also be of sintered composition.
 ** To avoid brake imbalance sintered pads fitted in rear calipers should only be used in combination with front calipers containing sintered pads.



CC KW FROM -> TO N° SET L/R COMPOUND



N° SET L/R COMPOUND

TORNAX

RX 80	80		→	FDB207				ST/P/EF/CP1			
-------	----	--	---	--------	--	--	--	-------------	--	--	--

TRE SOLDI

CR 80	80	1985	→	FDB207				ST/P/EF/CP1	FDB436		P
REGOLARITA' 80	80	1986	→ 1986	FSB911					FSB904		

TRIUMPH

BONNEVILLE 800 / T100	100	2001	→	FDB664				ST/P/EF	FDB497		ST/SM/SG/P/EF
T 100	100	1970	→	FSB919					FSB921		
T 120	120	1966	→	FSB919					FSB921		
T 140	140	1970	→	FSB919					FSB921		
T 150	150	1969	→	FSB919					FSB921		
BONNEVILLE T 400 V E	400		→ 1981	FDB342	2			P/CPRO	FDB342		P/CPRO
BONNEVILLE T 400 V E	400	1982	→ 1984	FRP213	2			P/CPRO	FDB342		P/CPRO
CUB 500	500		→	FSB916					FSB916		
TRIDENT TI 500 V	500		→ 1981	FDB342				P/CPRO	FDB342		P/CPRO
TRIDENT TI 500 V	500	1982	→ 1984	FRP213				P/CPRO	FDB342		P/CPRO
BABY SPEED 600	600	2004	→	FDB557	2			XRAC/ST/P/EF/CP1	FDB754		ST/P/EF
DAYTONA 600	600	2003	→	FDB557	2			XRAC/ST/P/EF/CP1	FDB754		ST/P/EF
SPEED FOUR 600	600	2002	→	FDB557	2			XRAC/ST/P/EF/CP1	FDB497		ST/SM/SG/P/EF
TT 600	600	2000	→ 2003	FDB557	2			XRAC/ST/P/EF/CP1	FDB531		ST/P/EF
THUNDERBIRD 650	650	1982	→ 1984	FRP213				P/CPRO			
DAYTONA 675	675	2009	→ 2012	FDB2252	2			ST	FDB531		ST/P/EF
DAYTONA 675	675	2013	→	FDB2252	2			ST	FDB2005		ST/SG/P/EF
DAYTONA 675 R	675	2011	→ 2012	FDB2260	2			XRAC/ST/CPRO	FDB531		ST/P/EF
DAYTONA 675 R	675	2013	→	FDB2260	2			XRAC/ST/CPRO	FDB2005		ST/SG/P/EF
DAYTONA 675 / Special Edition / Triple	675	2006	→ 2008	FDB2158	2			ST	FDB531		ST/P/EF
STREET TRIPLE 675	675	2007	→ 2012	FDB570	2			XRAC/ST/SM/P/EF/CPRO	FDB531		ST/P/EF
STREET TRIPLE 675	675	2013	→	FDB570	2			XRAC/ST/SM/P/EF/CPRO	FDB2005		ST/SG/P/EF
STREET TRIPLE 675 R	675	2009	→ 2012	FDB2158	2			ST	FDB531		ST/P/EF
STREET TRIPLE 675 R	675	2013	→	FDB2158	2			ST	FDB2005		ST/SG/P/EF
STREET TRIPLE 675 Rx	675	2015	→	FDB2158	2			ST	FDB2005		ST/SG/P/EF
BONNEVILLE 750 TWIN (Lockheed calipers)	750	1975	→ 1981	FDB342				P/CPRO	FDB342		P/CPRO
BONNEVILLE 750 TWIN (Lockheed calipers)	750	1982	→ 1984	FRP213				P/CPRO	FDB342		P/CPRO
BONNEVILLE 750 TWIN (Brembo calipers)	750	1985	→ 1986	FDB148				ST/P	FDB148		ST/P
DAYTONA 750 SPORT	750	1991	→ 1992	FDB557	2			XRAC/ST/P/EF/CP1	FDB631		ST/SM/SG/P/EF/AG
TIGER 750 TR 7V	750		→ 1975	FDB342				P/CPRO	FSB921		
TIGER 750 TR 7V	750	1976	→ 1981	FRP213				P/CPRO	FDB342		P/CPRO
TRIDENT 750	750	1992	→ 1998	FDB497			left	ST/SM/SG/P/EF			
TRIDENT 750	750	1992	→ 1998	FDB631			right	ST/SM/SG/P/EF/AG			
TRIDENT 750	750	1992	→ 1998						FDB631		ST/SM/SG/P/EF/AG
STREET TRIPLE 765 R	765	2017	→	FDB2265	2			ST/EF/CPRO	FDB2005		ST/SG/P/EF
STREET TRIPLE 765 RS	765	2017	→	FDB2260	2			XRAC/ST/CPRO	FDB2005		ST/SG/P/EF
STREET TRIPLE 765 S	765	2017	→	FDB570	2			XRAC/ST/SM/P/EF/CPRO	FDB2005		ST/SG/P/EF
Street Triple 765 R Low	765	2019	→	FDB2265	2			ST/EF/CPRO	FDB2005		ST/SG/P/EF
BONNEVILLE 800 (USA version)	800	2001	→	FDB570				XRAC/ST/SM/P/EF/CPRO	FDB531		ST/P/EF
TIGER 800	800	70	2011 → 2014	FDB570	2			XRAC/ST/SM/P/EF/CPRO	FDB531		ST/P/EF
TIGER 800 XC (A08)	800	70	2011 → 2014	FDB570	2			XRAC/ST/SM/P/EF/CPRO	FDB531		ST/P/EF
TIGER 800 Xca	800	2015	→ 2017	FDB570				XRAC/ST/SM/P/EF/CPRO	FDB531		ST/P/EF
TIGER 800 XRx (A082)	800	2015	→ 2017	FDB570	2			XRAC/ST/SM/P/EF/CPRO	FDB531		ST/P/EF
TIGER 800 XC (A082)	800	70	2015 → 2017	FDB570	2			XRAC/ST/SM/P/EF/CPRO	FDB531		ST/P/EF
TIGER 800 XCx (A082)	800	70	2015 → 2017	FDB570	2			XRAC/ST/SM/P/EF/CPRO	FDB531		ST/P/EF
TIGER 800 XR (A082)	800	70	2015 → 2017	FDB570	2			XRAC/ST/SM/P/EF/CPRO	FDB531		ST/P/EF
TIGER 800 XRT	800	2017	→ 2017	FDB570	2			XRAC/ST/SM/P/EF/CPRO	FDB531		ST/P/EF
TIGER 800 Xca	800	2018	→	FDB2018	2			ZR/ST/SG/P/EF	FDB531		ST/P/EF
TIGER 800 XRT	800	2018	→	FDB2018	2			ZR/ST/SG/P/EF	FDB531		ST/P/EF
TIGER 800 XRx Low	800	2018	→	FDB2018				ZR/ST/SG/P/EF	FDB531		ST/P/EF
TIGER 800 XCx (A082)	800	70	2018 →	FDB2018	2			ZR/ST/SG/P/EF	FDB531		ST/P/EF
AMERICA 865	865	2007	→	FDB664				ST/P/EF	FDB497		ST/SM/SG/P/EF
AMERICA 865 (12 Spoke Cast wheel)	865	2010	→	FDB664				ST/P/EF	FDB497		ST/SM/SG/P/EF
AMERICA LT 865	865	2014	→	FDB570				XRAC/ST/SM/P/EF/CPRO	FDB497		ST/SM/SG/P/EF
BONNEVILLE T100 865	865	2005	→	FDB664				ST/P/EF	FDB497		ST/SM/SG/P/EF
BONNEVILLE California Street Racer 865	865	2008	→	FDB664				ST/P/EF	FDB497		ST/SM/SG/P/EF
BONNEVILLE T100 BLACK	865	2012	→	FDB664				ST/P/EF	FDB497		ST/SM/SG/P/EF
BONNEVILLE T100 SE	865	2012	→	FDB664				ST/P/EF	FDB497		ST/SM/SG/P/EF
BONNEVILLE Newchurch	865	2015	→	FDB664				ST/P/EF	FDB497		ST/SM/SG/P/EF
BONNEVILLE Spirit	865	2015	→	FDB664				ST/P/EF	FDB497		ST/SM/SG/P/EF
BONNEVILLE T214	865	2015	→	FDB664				ST/P/EF	FDB497		ST/SM/SG/P/EF
SCRAMBLER 865	865	2006	→	FDB664				ST/P/EF	FDB497		ST/SM/SG/P/EF
SPEEDMASTER 865	865	2004	→	FDB570	2			XRAC/ST/SM/P/EF/CPRO	FDB497		ST/SM/SG/P/EF

* It is recommended that in those applications where sintered pads are supplied as Original Equipment, replacement pads should also be of sintered composition.

** To avoid brake imbalance sintered pads fitted in rear calipers should only be used in combination with front calipers containing sintered pads.



CC KW FROM -> TO N° SET L/R COMPOUND N° SET L/R COMPOUND

...TRIUMPH

SPEEDMASTER	865	2010	→	FDB664				ST/P/EF	FDB497			ST/SM/SG/P/EF
ADVENTURER 900	900	1996	→ 2001	FDB570				XRAC/ST/SM/P/EF/CPRO	FDB570			XRAC/ST/SM/P/EF/CPRO
DAYTONA 900	900	1993	→ 1996	FDB557	2			XRAC/ST/P/EF/CP1	FDB631			ST/SM/SG/P/EF/AG
DAYTONA SPRINT 900	900	1993	→	FDB497			left	ST/SM/SG/P/EF				
DAYTONA SPRINT 900	900	1993	→	FDB631			right	ST/SM/SG/P/EF/AG				
DAYTONA SPRINT 900	900	1993	→						FDB631			ST/SM/SG/P/EF/AG
DAYTONA SPRINT 900	900	1994	→ 1998	FDB557	2			XRAC/ST/P/EF/CP1	FDB631			ST/SM/SG/P/EF/AG
DAYTONA SUPER III 900	900	1994	→ 1997	FDB864	2			ST/P	FDB631			ST/SM/SG/P/EF/AG
LEGEND 900 TT	900	1999	→ 2001	FDB570				XRAC/ST/SM/P/EF/CPRO	FDB570			XRAC/ST/SM/P/EF/CPRO
SCRAMBLER 900	900	2010	→	FDB664				ST/P/EF	FDB497			ST/SM/SG/P/EF
SPEED TRIPLE 900	900	1994	→	FDB557	2			XRAC/ST/P/EF/CP1	FDB631			ST/SM/SG/P/EF/AG
STREET CUP	900	2017	→	FDB664				ST/P/EF	FDB497			ST/SM/SG/P/EF
STREET SCRAMBLER	900	2017	→	FDB664				ST/P/EF	FDB497			ST/SM/SG/P/EF
STREET TWIN (DP01)	900	40	2016	→	FDB664			ST/P/EF	FDB497			ST/SM/SG/P/EF
THRUXTON 900	900	2004	→ 2007	FDB570				XRAC/ST/SM/P/EF/CPRO	FDB497			ST/SM/SG/P/EF
THRUXTON 900	900	2008	→	FDB664				ST/P/EF	FDB497			ST/SM/SG/P/EF
THRUXTON 900 (Front Brembo caliper)	900	2008	→	FDB2042	2			ZRAC/XRAC/ST/P/EF/CPRO	FDB497			ST/SM/SG/P/EF
THRUXTON 900 ACE	900	2015	→	FDB664				ST/P/EF	FDB497			ST/SM/SG/P/EF
THUNDERBIRD 900 / SPORT	900	1995	→	FDB570	2			XRAC/ST/SM/P/EF/CPRO	FDB570			XRAC/ST/SM/P/EF/CPRO
TIGER 900	900	1993	→ 1998	FDB497			left	ST/SM/SG/P/EF				
TIGER 900	900	1993	→ 1998	FDB631			right	ST/SM/SG/P/EF/AG				
TIGER 900	900	1993	→ 1998						FDB631			ST/SM/SG/P/EF/AG
TRIDENT 900 SPRINTER	900	1993	→ 1998	FDB497			left	ST/SM/SG/P/EF				
TRIDENT 900 SPRINTER	900	1993	→ 1998	FDB631			right	ST/SM/SG/P/EF/AG				
TRIDENT 900 SPRINTER	900	1993	→ 1998						FDB631			ST/SM/SG/P/EF/AG
TROPHY 900	900	1993	→ 1995	FDB497			left	ST/SM/SG/P/EF				
TROPHY 900	900	1993	→ 1995	FDB631			right	ST/SM/SG/P/EF/AG				
TROPHY 900	900	1993	→ 1995						FDB631			ST/SM/SG/P/EF/AG
TROPHY 900	900	1996	→ 1998	FDB557	2			XRAC/ST/P/EF/CP1	FDB631			ST/SM/SG/P/EF/AG
DAYTONA 955i	955	1997	→ 2000	FDB557	2			XRAC/ST/P/EF/CP1	FDB497			ST/SM/SG/P/EF
DAYTONA 955i	955	2001	→ 2004	FDB557	2			XRAC/ST/P/EF/CP1	FDB531			ST/P/EF
SPEED TRIPLE 955	955	2002	→	FDB557	2			XRAC/ST/P/EF/CP1	FDB497			ST/SM/SG/P/EF
SPRINT RS 955 double sided swing arm	955	1999	→ 2002	FDB557	2			XRAC/ST/P/EF/CP1	FDB631			ST/SM/SG/P/EF/AG
SPRINT RS 955 double sided swing arm	955	2003	→ 2004	FDB557	2			XRAC/ST/P/EF/CP1	FDB497			ST/SM/SG/P/EF
SPRINT RS 955 single sided swing arm	955	2003	→ 2004	FDB557	2			XRAC/ST/P/EF/CP1	FDB497			ST/SM/SG/P/EF
SPRINT ST 955	955	1999	→ 2004	FDB557	2			XRAC/ST/P/EF/CP1	FDB497			ST/SM/SG/P/EF
TIGER 955i	955	77	2001	→ 2006	FDB570	2		XRAC/ST/SM/P/EF/CPRO	FDB631			ST/SM/SG/P/EF/AG
DAYTONA 1000 SPORT	1000	1991	→ 1992	FDB557	2			XRAC/ST/P/EF/CP1	FDB631			ST/SM/SG/P/EF/AG
SPEED TRIPLE 1050	1050	2004	→ 2007	FDB2158	2			ST	FDB497			ST/SM/SG/P/EF
SPEED TRIPLE 1050	1050	2007	→ 2012	FDB2120	2			ZRAC/XRAC/ST	FDB497			ST/SM/SG/P/EF
SPEED TRIPLE R 1050	1050	2012	→	FDB2260	2			XRAC/ST/CPRO	FDB497			ST/SM/SG/P/EF
SPEED TRIPLE R	1050	2016	→	FDB2260	2			XRAC/ST/CPRO	FDB497			ST/SM/SG/P/EF
SPEED TRIPLE S	1050	2016	→	FDB2260	2			XRAC/ST/CPRO	FDB497			ST/SM/SG/P/EF
Speed Triple RS	1050	110	2019	→	FDB2260	2		XRAC/ST/CPRO	FDB497			ST/SM/SG/P/EF
SPRINT GT 1050	1050	2011	→	FDB557	2			XRAC/ST/P/EF/CP1	FDB497			ST/SM/SG/P/EF
SPRINT ST 1050 / ABS	1050	2004	→	FDB557	2			XRAC/ST/P/EF/CP1	FDB497			ST/SM/SG/P/EF
TIGER SE ABS 1050	1050	2008	→	FDB2158	2			ST	FDB631			ST/SM/SG/P/EF/AG
TIGER XC	1050	2011	→	FDB664	2			ST/P/EF	FDB531			ST/P/EF
TIGER SPORT	1050	2013	→	FDB2158	2			ST	FDB631			ST/SM/SG/P/EF/AG
BONNEVILLE T120 (DU01)	1200	59	2016	→	FDB664	2		ST/P/EF	FDB497			ST/SM/SG/P/EF
BONNEVILLE T120 BLACK (DU01)	1200	59	2016	→	FDB664	2		ST/P/EF	FDB497			ST/SM/SG/P/EF
BONNEVILLE BOBBER	1200	57	2017	→	FDB664			ST/P/EF	FDB531			ST/P/EF
BONNEVILLE BOBBER BLACK	1200	57	2017	→	FDB664			ST/P/EF	FDB531			ST/P/EF
Bonneville Speedmaster	1200	57	2019	→	FDB664	2		ST/P/EF	FDB2005			ST/SG/P/EF
DAYTONA 1200	1200	1993	→ 1998	FDB557	2			XRAC/ST/P/EF/CP1	FDB631			ST/SM/SG/P/EF/AG
Scrambler 1200 XE	1200	66	2019	→	FDB2260	2		XRAC/ST/CPRO	FDB2006			ST/P/EF
Scrambler 1200 XC	1200	66	2020	→	FDB2260	2		XRAC/ST/CPRO	FDB2006			ST/P/EF
Speed twin	1200	71	2020	→	FDB2120	2		ZRAC/XRAC/ST	FDB497			ST/SM/SG/P/EF
THRUXTON	1200	2016	→	FDB664	2			ST/P/EF	FDB497			ST/SM/SG/P/EF
THRUXTON R+	1200	2019	→	FDB2260	2			XRAC/ST/CPRO	FDB497			ST/SM/SG/P/EF
ThruXton TFC	1200	2020	→	FDB2260	2			XRAC/ST/CPRO	FDB497			ST/SM/SG/P/EF
ThruXton RS	1200	77	2020	→	FDB2260	2		XRAC/ST/CPRO	FDB497			ST/SM/SG/P/EF
TROPHY 1200	1200	1993	→ 1995	FDB497			left	ST/SM/SG/P/EF				
TROPHY 1200	1200	1993	→ 1995	FDB631			right	ST/SM/SG/P/EF/AG				
TROPHY 1200	1200	1993	→ 1995						FDB631			ST/SM/SG/P/EF/AG
TROPHY 1200	1200	1996	→ 2001	FDB557	2			XRAC/ST/P/EF/CP1	FDB631			ST/SM/SG/P/EF/AG
TIGER EXPLORER 1200	1215	2012	→	FDB557	2			XRAC/ST/P/EF/CP1	FDB497			ST/SM/SG/P/EF
TIGER EXPLORER XC 1200	1215	2013	→	FDB557	2			XRAC/ST/P/EF/CP1	FDB497			ST/SM/SG/P/EF
TIGER EXPLORER Xc	1215	2016	→	FDB2265	2			ST/EF/CPRO	FDB497			ST/SM/SG/P/EF
TIGER EXPLORER Xca	1215	2016	→	FDB2265	2			ST/EF/CPRO	FDB497			ST/SM/SG/P/EF
TIGER EXPLORER Xcx	1215	2016	→	FDB2265	2			ST/EF/CPRO	FDB497			ST/SM/SG/P/EF
TIGER EXPLORER XR	1215	2016	→	FDB2265	2			ST/EF/CPRO	FDB497			ST/SM/SG/P/EF
TIGER EXPLORER XRt	1215	2016	→	FDB2265	2			ST/EF/CPRO	FDB497			ST/SM/SG/P/EF
TIGER EXPLORER XRx	1215	2016	→	FDB2265	2			ST/EF/CPRO	FDB497			ST/SM/SG/P/EF

* It is recommended that in those applications where sintered pads are supplied as Original Equipment, replacement pads should also be of sintered composition.

** To avoid brake imbalance sintered pads fitted in rear calipers should only be used in combination with front calipers containing sintered pads.



CC KW FROM -> TO N° SET L/R COMPOUND

N° SET L/R COMPOUND

...TRIUMPH

TROPHY SE	1215	2012	→	FDB2085	2		ST/SM/P/EF	FDB497		ST/SM/SG/P/EF
THUNDERBIRD 1600	1600	2009	→	FDB557	2		XRAC/ST/P/EF/CP1	FDB2006		ST/P/EF
THUNDERBIRD STORM 1700	1700	2011	→	FDB557	2		XRAC/ST/P/EF/CP1	FDB2006		ST/P/EF
THUNDERBIRD COMANDER	1700	2014	→	FDB557	2		XRAC/ST/P/EF/CP1	FDB2006		ST/P/EF
THUNDERBIRD LT	1700	2014	→	FDB557	2		XRAC/ST/P/EF/CP1	FDB2006		ST/P/EF
THUNDERBIRD NIGHT STORM	1700	2015	→	FDB557	2		XRAC/ST/P/EF/CP1	FDB2006		ST/P/EF
ROCKET III ROADSTER	2294	2010	→	FDB557	2		XRAC/ST/P/EF/CP1	FDB2006		ST/P/EF
ROCKET X	2294	2015	→	FDB557	2		XRAC/ST/P/EF/CP1	FDB2006		ST/P/EF
ROCKET 2300 /Rocket III Classic/Touring/Roadster	2300	2004	→	FDB557	2		XRAC/ST/P/EF/CP1	FDB2006		ST/P/EF
Rocket 3GT	2458	123	2020	→	FDB2260	2		XRAC/ST/CPRO	FDB2265	ST/EF/CPRO
Rocket 3R	2458	123	2020	→	FDB2260	2		XRAC/ST/CPRO	FDB2265	ST/EF/CPRO

TVS

Scotty ES	85	2005	→	FSB979				FSB979		
Scooty Pep+	87	4	2005	→	FSB979			FSB979		
Scooty Pep+	87	3	2015	→	FSB979			FSB979		
AX100	100	1992	→ 2004	FSB722				FSB722		
StarCity	109	6	2006	→	FSB979			FSB979		
StarCity +	109	6	2015	→	FSB979			FSB979		
Victor GL	109	6	2003	→	FSB979			FSB979		
Victor	109	7	2016	→	FSB979			FSB979		
Star City	110	2004	→	FSB979				FSB979		
Victor	110	2001	→ 2007	FSB979				FSB979		
Victor 125 GLX	124	7	2004	→	FSB979			FSB979		
Victor Edge	124	7	2005	→	FSB979			FSB979		
Rockz	125		→	FDB2087			EF			
Stryker	125		→	FDB2087			EF			
Victor	125	2004	→ 2008	FSB979				FSB979		
Apache 150	147	10	2005	→	FDB2087		EF	FSB979		
Apache	150	2006	→ 2008	FDB2087			EF	FSB979		
Fiero F2	150	2003	→ 2006	FDB2080			SG	FSB979		
Apache RTR 160	159	11	2015	→	FDB2087		EF	FSB979		
Apache	160	2008	→	FDB2087			EF	FSB979		
Apache RTR 160 Hyper Edge	160	11	2010	→	FDB2087		EF	FDB2286		EF
Apache RTR	180	2009	→	FDB2087			EF	FDB2286		EF
Apache RTR	200		→	FDB2087			EF	FDB2286		EF

URAL

RETRO 750	750	2005	→	FDB2042			ZRAC/XRAC/ST/P/EF/CPRO			
-----------	-----	------	---	---------	--	--	------------------------	--	--	--

VALENTI

80	80		→	FSB834				FSB834		
----	----	--	---	--------	--	--	--	--------	--	--

VICTORY

Cross Country		2010	→ 2014	FDB2158	2		ST	FDB664		ST/P/EF
Cross Country Tour		2012	→ 2015	FDB2158	2		ST	FDB664		ST/P/EF
Cross Country 8-Ball		2015	→	FDB2158	2		ST	FDB664		ST/P/EF
Cross Roads		2010	→ 2012	FDB2158	2		ST	FDB664		ST/P/EF
Cross Roads Classic (Spoke Wheel)		2013	→ 2014	FDB2158	2		ST	FDB664		ST/P/EF
Cross Roads 8 - Ball (Cast Wheel)		2014	→	FDB2158	2		ST	FDB664		ST/P/EF
Cross Touring		2013	→ 2014	FDB2158	2		ST	FDB664		ST/P/EF
Empulse TT		2016	→	FDB2042	2		ZRAC/XRAC/ST/P/EF/CPRO	FDB2074		ST/SM/P/EF/CPRO/AG
Gunner		2015	→	FDB2158			ST	FDB664		ST/P/EF
Hammer S			→ 2007	FDB2042	2		ZRAC/XRAC/ST/P/EF/CPRO	FDB2006		ST/P/EF
Hammer		2005	→ 2007	FDB2042	2		ZRAC/XRAC/ST/P/EF/CPRO	FDB2006		ST/P/EF
Hammer		2008	→ 2011	FDB2158	2		ST	FDB664		ST/P/EF
Hammer S		2008	→ 2015	FDB2158	2		ST	FDB664		ST/P/EF
Hammer 8 Ball		2010	→ 2015	FDB2158	2		ST	FDB664		ST/P/EF
Hard Ball		2012	→ 2013	FDB2158	2		ST	FDB664		ST/P/EF
Highball (Cast & Spoke Wheel)		2012	→	FDB2158			ST	FDB664		ST/P/EF
Jackpot		2010	→ 2014	FDB2158			ST	FDB664		ST/P/EF
Judge		2013	→	FDB2158			ST	FDB664		ST/P/EF
King Pin		2004	→ 2007	FDB2042			ZRAC/XRAC/ST/P/EF/CPRO	FDB2006		ST/P/EF
King Pin Tour		2004	→ 2007	FDB2042			ZRAC/XRAC/ST/P/EF/CPRO	FDB2006		ST/P/EF
King Pin		2008	→ 2012	FDB2158			ST	FDB664		ST/P/EF
Kingpin 8-Ball		2008	→ 2011	FDB2158			ST	FDB664		ST/P/EF
Kingpin Tour		2008	→ 2009	FDB2158			ST	FDB664		ST/P/EF

* It is recommended that in those applications where sintered pads are supplied as Original Equipment, replacement pads should also be of sintered composition.

** To avoid brake imbalance sintered pads fitted in rear calipers should only be used in combination with front calipers containing sintered pads.

1100



CC KW FROM -> TO N° SET L/R COMPOUND



N° SET L/R COMPOUND

...VICTORY

King Pin Low		2009 → 2009	FDB2158			ST	FDB664		ST/P/EF
Magnum		2015 →	FDB2158	2		ST	FDB664		ST/P/EF
Magnum X-1		2015 →	FDB2158	2		ST	FDB664		ST/P/EF
Ness Signature Series		2005 → 2007	FDB2042			ZRAC/XRAC/ST/P/EF/CPRO	FDB2006		ST/P/EF
Cory Ness Jackpot		2008 → 2010	FDB2158			ST	FDB664		ST/P/EF
Zach Ness Vegas		2008 → 2012	FDB2158			ST	FDB664		ST/P/EF
Arlen Ness Victory Vision		2010 → 2012	FDB2098	2		ST/P/EF	FDB664		ST/P/EF
Cory Ness Cross Country		2011 → 2012	FDB2158	2		ST	FDB664		ST/P/EF
Broadwalk		2013 → 2015	FDB2158			ST	FDB664		ST/P/EF
V92SC		2000 → 2003	FDB2042	2		ZRAC/XRAC/ST/P/EF/CPRO	FDB2006		ST/P/EF
Vegas		2003 → 2007	FDB2042			ZRAC/XRAC/ST/P/EF/CPRO	FDB2006		ST/P/EF
Vegas 8-Ball		2005 → 2007	FDB2042			ZRAC/XRAC/ST/P/EF/CPRO	FDB2006		ST/P/EF
Vegas Jackpot		2006 → 2007	FDB2042			ZRAC/XRAC/ST/P/EF/CPRO	FDB2006		ST/P/EF
Vegas		2008 →	FDB2158			ST	FDB664		ST/P/EF
Vegas 8-Ball		2008 → 2015	FDB2158			ST	FDB664		ST/P/EF
Vegas Jackpot		2008 → 2009	FDB2158			ST	FDB664		ST/P/EF
Vegas Low		2008 → 2009	FDB2158			ST	FDB664		ST/P/EF
Vision Street		2008 → 2009	FDB2098	2		ST/P/EF	FDB664		ST/P/EF
Vision Tour (All models)		2008 → 2015	FDB2098	2		ST/P/EF	FDB664		ST/P/EF
Vision 8 Ball		2010 → 2011	FDB2098	2		ST/P/EF	FDB664		ST/P/EF
V92C (All models single front rotor)	1500	1998 → 2003	FDB2042			ZRAC/XRAC/ST/P/EF/CPRO	FDB2006		ST/P/EF

YAMAHA

50 AXIS	50	1993 →	FDB636			P/EF	FSB704		
50 AXIS PROFOOT	50	1994 →	FDB636			P/EF	FSB704		
50 BELUGA	50	→ 1989	FSB739				FSB739		
50 BELUGA	50	1990 → 1995	FSB738				FSB739		
50 BREEZE	50	1994 → 1996	FDB680			ST/EF	FSB738		
BW'S 50	50	1992 → 1994	FSB738				FSB738		
BW'S / ZUMA II 50	50	1995 →	FDB680			ST/EF	FSB738		
BW's NAKED 50	50	2003 → 2004	FDB680			ST/EF	FSB731		
BW'S 50	50	2004 → 2004	FDB680			ST/EF	FSB731		
BW's 50	50	2005 →	FDB680			ST/EF			
BW's NAKED 50	50	2009 →	FDB680			ST/EF			
CA 50 SALIENT	50	1983 → 1986	FSB730				FSB739		
50 CHAPPY	50	1980 →	FSB732				FSB732		
CR 50 TARGET	50	1991 →	FDB636			P/EF	FSB731		
CR 50 Z	50	1992 →	FDB636			P/EF	FSB731		
CS 50 Jog R	50	2002 → 2005	FDB680			ST/EF	FSB731		
CS 50 Z (Jog RR)	50	2003 → 2005	FDB680			ST/EF	FSB731		
CS 50 Jog R	50	2006 →	FDB680			ST/EF			
CS 50 Z (Jog RR)	50	2006 → 2012	FDB680			ST/EF			
CT 50 SUPER SPORT	50	1990 →	FSB731				FSB731		
CW 50 RS	50	1995 →	FDB889			ST/EF	FSB738		
CY 50 JOG-IN	50	1991 → 1995	FSB739				FSB738		
DT 50 M - MX	50	1978 → 1987	FSB732				FSB732		
DT 50	50	1988 → 1992	FSB738				FSB738		
DT 50 R	50	1993 → 1997	FDB383			SG/P/EF	FSB738		
DT 50 LCD	50	1996 → 1998	FDB2015			SG	FSB731		
DT 50 R	50	1997 →	FDB697			EF	FSB731		
DT 50 R	50	2002 → 2007	FDB697			EF	FRP405		ST/SG/PRP/P/EF
DT 50 R SM	50	2004 →	FDB677			P/EF	FDB2128		EF
DT 50 R	50	2008 →	FDB2107			P	FDB2107		P
DT 50 X	50	2008 →	FDB677			P/EF	FDB2128		EF
EW 50 SLIDER	50	2000 → 2003	FDB889			ST/EF	FSB731		
50 FLY ONE	50	1992 → 1995	FDB383			SG/P/EF	FSB704		
FS 1 50 E	50	1974 → 1975	FSB732				FSB732		
FS 1 50 E DX	50	1976 → 1979					FSB732		
FS 1 50 SE	50	1981 → 1982	FSB732				FSB732		
FZR 50	50	1990 → 1991	FDB631			ST/SM/SG/P/EF/AG	FDB386		ST/P/EF
FZR 50	50	1992 →	FDB497			ST/SM/SG/P/EF	FDB659		SG/P/EF
50 GRAFIX	50	1993 →	FSB738				FSB738		
JOG 50 (Brasil)	50	→					FSB739		
JOG 50 (España)	50	1988 →	FDB636			P/EF	FSB739		
JOG 50	50	1990 → 1991	FSB738				FSB738		
JOG 50 (Italia)	50	1993 →	FDB636			P/EF	FSB704		
JOG 50 Z (Italia) - R / RR	50	1993 →	FDB889			ST/EF			
LB 2 50 M CHAPPY	50	1980 →	FSB732				FSB732		
LC 50 M	50	1980 →	FSB732				FSB732		
LC 50 M BOP	50	1980 →	FSB739				FSB739		
MA 50 M	50	1981 →	FSB730				FSB730		
MINI 50 L SHAFT	50	1983 →					FSB738		

* It is recommended that in those applications where sintered pads are supplied as Original Equipment, replacement pads should also be of sintered composition.

** To avoid brake imbalance sintered pads fitted in rear calipers should only be used in combination with front calipers containing sintered pads.



CC KW FROM -> TO N° SET L/R COMPOUND N° SET L/R COMPOUND

...YAMAHA

MINT 50	50	1996 →	FSB730				FSB739			
MJ 50 M TOWNY	50	1981 → 1993	FSB730				FSB730			
MS 50	50	1985 → 1986	FSB730				FSB739			
NS 50 F (1GB) AEROX 4 (4T)	50	2013 →	FDB680			ST/EF	FDB2062			EF
NS 50 AEROX R	50	2013 →	FDB680			ST/EF	FDB2062			EF
NS 50 AEROX R NAKED	50	2013 →	FDB680			ST/EF	FDB2062			EF
PW 50	50	1980 → 2013	FSB730				FSB730			
QA 50 POCKE	50	1983 →	FSB730				FSB730			
QB 50 VOGEL	50	1983 →	FSB730				FSB730			
QT 50	50	1980 →	FSB730				FSB730			
RD 50 M	50	1978 →					FSB732			
RD 50 MX	50	1981 → 1987	FDB277			P	FSB732			
RS 50 CHAMP	50	1988 →	FDB636			P/EF	FSB739			
SA 50 M - ME PASSOLA	50	1980 → 1984	FSB730				FSB739			
SG 50 STING	50	1984 →	FSB739				FSB739			
SH 50 RAZZ	50	1993 →	FSB730				FSB739			
50 SPY	50	1996 → 1998	FDB680			ST/EF	FSB731			
TDR 50	50	1990 →	FDB383			SG/P/EF	FDB383			SG/P/EF
50 TRAFIC	50	1993 →	FSB738				FSB738			
50 TRUNK	50	1994 →	FDB636			P/EF	FSB704			
TT-R 50	50	2006 → 2013	FSB702				FSB702			
TY 50 M	50	1979 →	FSB732				FSB732			
TZM 50 R	50	1994 →	FDB636			P/EF	FDB383			SG/P/EF
TZR 50	50	1990 → 1996	FDB636			P/EF	FDB383			SG/P/EF
TZR 50	50	1997 → 2003	FDB631			ST/SM/SG/P/EF/AG				
TZR 50 /Race Replica 07	50	2004 →	FDB677			P/EF	FRP405			ST/SG/PRP/P/EF
V 50 M - P	50	1974 → 1982	FSB732				FSB732			
V 50 M	50	1983 →	FSB738				FSB738			
YE 50 ZEST	50	1992 →	FDB889			ST/EF	FSB731			
YE 50 ZEST	50	1993 → 1995	FDB889			ST/EF	FSB738			
YH 50 WHY	50	1999 →	FDB889			ST/EF	FSB731			
YN 50 R NEO'S	50	1997 → 2002	FDB680			ST/EF	FSB731			
YN 50 NEO'S	50	2002 → 2006	FDB680			ST/EF	FSB731			
YN 50 NEO'S 2T	50	2007 →	FDB680			ST/EF				
YN 50 NEO'S 4T	50	2009 →	FDB680			ST/EF				
YQ 50 AEROX / AEROX R	50	1997 → 2012	FDB889			ST/EF	FDB2062			EF
YSR 50	50	1986 → 1987	FDB475			AG	FSB731			
YZ 50 G - H - J - K	50	1980 → 1983	FSB764				FSB764			
50 ZUMA	50	1996 →	FDB680			ST/EF	FSB738			
YSR 60	60	1986 → 1987	FDB475			AG	FSB731			
YZ 60	60	1985 →	FSB764				FSB764			
YZ 65	65	2018 →	FDB2015			SG	FDB661			SG/P
V 70 A	70	1976 →	FSB732				FSB732			
80 BELUGA	80	→ 1989	FSB731				FSB731			
80 BELUGA	80	1990 →	FSB738				FSB739			
BOP 80 2	80	1980 →	FSB732				FSB732			
DT 80 (Espana)	80	→	FSB738				FSB738			
DT 80 MX - MX-S	80	1981 →	FSB732				FSB732			
DT 80 LC	80	1981 →	FSB732				FSB732			
DT 80 LC - LC II - N	80	1985 →	FDB475			AG	FSB732			
DT 80 LC (Espana)	80	1989 →	FDB499			P	FSB738			
DT 80 LC2	80	1993 →	FDB383			SG/P/EF	FSB733			
FS 80 SE	80	1981 → 1982	FSB732				FSB732			
PW 80 K	80	1983 → 1990	FSB764				FSB764			
PW 80	80	1991 →	FSB739				FSB738			
RD 80 AIR COOLED	80	1981 → 1982	FDB277			P	FSB732			
RD 80 MX	80	1981 → 1982	FDB277			P	FSB732			
RD 80 LC1	80	1982 →	FDB311			P	FSB733			
RD 80 LC2 - LCS	80	1982 →	FDB311			P	FSB732			
RX 80 SE	80	1982 →	FDB277			P	FSB732			
T 80 TOWNMATE	80	1983 → 1997	FSB738				FSB738			
TDR 80	80	1989 →	FDB475			AG	FDB475			AG
TY 80	80	1977 →	FSB764				FSB732			
TY 80	80	1983 →	FSB764				FSB731			
TZR 80	80	→ 1991	FDB386			ST/P/EF	FSB733			
TZR 80	80	1992 →	FDB636			P/EF	FDB383			SG/P/EF
V 80	80	1979 → 1982	FSB732				FSB732			
V 80	80	1983 →	FSB738				FSB738			
YSR 80	80	1986 →	FDB475			AG	FSB731			
YZ 80	80	1977 → 1979	FSB764				FSB732			
YZ 80	80	1980 → 1985	FSB764				FSB764			
YZ 80	80	1986 → 1992	FDB2015			SG	FSB764			
YZ 80	80	1993 → 2001	FDB2015			SG	FDB661			SG/P
YZ 85 LW	85	2002 →	FDB2015			SG	FDB661			SG/P

* It is recommended that in those applications where sintered pads are supplied as Original Equipment, replacement pads should also be of sintered composition.

** To avoid brake imbalance sintered pads fitted in rear calipers should only be used in combination with front calipers containing sintered pads.



	CC	KW	FROM -> TO		N° SET	L/R	COMPOUND		N° SET	L/R	COMPOUND	
...YAMAHA												
90 AXIS (Brasil)	90		→	FDB636			P/EF					
CR 90 TARGET	90	1991	→	FDB636			P/EF	FSB731				
JOG 90 (Brasil)	90		→	FDB636			P/EF	FSB739				
JOG 90	90	1990	→ 1994	FDB636			P/EF	FSB739				
TT-R 90	90	2000	→ 2004	FSB764				FSB731				
V 90	90	1978	→	FSB732				FSB732				
BW' S 100	100	2000	→ 2002	FDB636			P/EF	FSB947				
DT 100	100	1976	→ 1980	FSB732				FSB733				
RS 100	100	1975	→ 1977	FSB732				FSB732				
RS 100 all models	100	1977	→ 1980					FSB732				
RS Zero	100	2017	→	FDB2310			EF					
RT 100	100	1994	→ 2003	FSB731				FSB731				
RX 100	100	1983	→ 1996	FSB738				FSB738				
RX100	100	1985	→ 1996	FSB977				FSB977				
YB 100	100	1978	→ 1981	FSB732				FSB732				
YB 100	100	1982	→ 1986	FSB732				FSB731				
YB 100	100	1987	→ 1992	FSB731				FSB731				
YN 100 NEO'S	100	2000	→ 2003	FDB889			ST/EF	FSB947				
YQ 100 AEROX	100	2000	→ 2002	FDB889			ST/EF	FSB733				
YZ 100 E - F - G - H	100	1978	→ 1981	FSB732				FSB733				
YZ 100 J - K	100	1982	→ 1983	FSB731				FSB733				
105 CRIPTON	105	1996	→ 1998	FDB2083			ST/SM/P/EF	FSB738				
Liberio	110	2002	→ 2010	FSB977				FSB977				
TT-R 110	110	2008	→	FSB764				FSB731				
Cuxi	115	2017	→	FDB2311			EF					
XC 115 D'elight	115	2014	→	FDB2238			P/EF					
X-Max 125 ABS	124	2018	→	FDB2280			ST/EF/CPRO/CP1	FDB2283			EF	
YS 125	125	2017	→	FDB2238			P/EF					
125 ACTIVE	125	1990	→	FSB733				FSB733				
BL 125 BELUGA	125	1985	→ 1987	FSB733				FSB733				
BL 125 BELUGA	125	1988	→ 1992	FSB772				FSB733				
BL 125 BELUGA	125	1993	→ 1995	FSB772				FSB947				
125 BIKAN	125	1991	→	FDB386			ST/P/EF	FDB337			ST/P/EF	
BW's 125	125	2010	→	FDB2264			EF	FSB967				
125 D'elight	125	2018	→	FDB2290			EF					
DT 125 E - LC - MX	125	1974	→ 1984	FSB733				FSB733				
DT 125 LC - R	125	1985	→ 1986	FDB475			AG	FSB733				
DT 125 (Italia)	125	1986	→ 1987	FDB438			P/EF	FSB733				
DT 125 TENERE (Italia)	125	1987	→	FDB438			P/EF	FSB733				
DT 125 CHESTERFIELD SCOUT	125	1988	→	FDB592			P	FSB733				
DT 125 LC / R	125	1988	→	FDB475			AG	FDB383			SG/P/EF	
DT 125 LC TENERE	125	1988	→	FDB592			P	FSB733				
DT 125 CHESTERFIELD SCOUT	125	1989	→	FDB499			P	FSB733				
DT 125 R	125	1991	→ 2003	FDB383			SG/P/EF	FDB383			SG/P/EF	
DT 125 MX (drum brakes)	125	1992	→	FSB733				FSB733				
DT 125 RE	125	2004	→	FDB383			SG/P/EF					
Enticer	125	2002	→ 2005	FDB2018			ZR/ST/SG/P/EF	FSB974				
Fazer	125	2004	→ 2006	FDB2018			ZR/ST/SG/P/EF	FSB974				
IT 125 G - H - J	125	1980	→ 1982	FSB732				FSB733				
MAXTER 125	125	2001	→ 2003	FDB2018			ZR/ST/SG/P/EF	FDB2074			ST/SM/P/EF/CPRO/AG	
MT-125 (RE11)	125	11	2015 → 2019	FDB2216			ST/SM/P/CP1	FDB2184			SG/P	
MT-125A (RE11) ABS	125	11	2015 → 2019	FDB2216			ST/SM/P/CP1	FDB2184			SG/P	
MT-125	125	2020	→	FDB2216			ST/SM/P/CP1	FDB659			SG/P/EF	
NCX 125 CYGNUS X 220mm disc (5ML)	125	2004	→ 2006	FDB2224			P/EF	FSB967				
NCX 125 CYGNUS X 240mm disc (4P9)	125	2006	→ 2013	FDB2224			P/EF	FSB967				
NMAX (GPD125A)	125	2015	→	FDB2290			EF	FDB2238			P/EF	
NXC 125 K CYGNUS X Cab (HC6-1)	125	2007	→ 2010	FDB2284			EF	FSB967				
NXC 125 K CYGNUS X Injection (4C6-2)	125	2007	→ 2010	FDB2284			EF	FSB967				
RD 125 DX	125	1975	→ 1977					FSB733				
RD 125 LC	125	1982	→ 1984	FDB311			P	FSB733				
RD 125 LC R	125	1985	→ 1987	FDB386			ST/P/EF	FSB733				
RIVA 125 XX	125	1993	→	FSB772				FSB947				
RS 125	125	1975	→	FSB734				FSB733				
RS 125 DX	125	1976	→ 1980					FSB733				
SR 125 SE	125	1982	→ 1992	FSB733				FSB731				
SR 125	125	1993	→ 1996	FDB311			P	FSB763				
SR 125	125	1997	→ 2003	FDB2003			ST/SM/P/EF	FSB731				
TD 125 R	125	1993	→	FDB383			SG/P/EF	FDB383			SG/P/EF	
TDR 125 (Italia)	125	1990	→ 1991	FDB499			P	FDB314			ST/SG/P/EF	
TDR 125	125	1992	→	FDB499			P	FDB207			ST/P/EF/CP1	
TDR 125	125	1993	→ 1993	FDB2003			ST/SM/P/EF	FDB383			SG/P/EF	
TDR 125 R	125	1993	→ 2003	FDB781			ST/P/EF	FDB475			AG	
Tricity 125	125	8	2014 →	FDB2296		left	EF					
Tricity 125	125	8	2014 →	FDB2297		right	EF					

* It is recommended that in those applications where sintered pads are supplied as Original Equipment, replacement pads should also be of sintered composition.

** To avoid brake imbalance sintered pads fitted in rear calipers should only be used in combination with front calipers containing sintered pads.



CC KW FROM -> TO N° SET L/R COMPOUND N° SET L/R COMPOUND

...YAMAHA

Tricity 125	125	8	2014 →				FDB2143			P/EF
TT-R 125	125		2000 →	FSB731			FSB731			
TT-R 125 LW	125		2000 → 2012	FDB2015		SG	FSB731			
TW 125	125		1998 → 2002	FDB2083		ST/SM/P/EF	FSB731			
TW 125	125		2003 →	FDB2083		ST/SM/P/EF				
TY 125	125		1982 →	FSB732			FSB733			
TZ 125	125		1997 →	FDB557		XRAC/ST/P/EF/CP1	FDB2194			P
TZR 125	125		1987 → 1989	FDB386		ST/P/EF	FSB733			
TZR 125	125		1990 → 1992	FDB337		ST/P/EF	FDB386			ST/P/EF
TZR 125 (Italia)	125		1991 →	FRP408		XRAC/ST/PR/PI/CPRO/CP1	FDB207			ST/P/EF/CP1
TZR 125	125		1993 →	FDB2003		ST/SM/P/EF	FDB383			SG/P/EF
TZR 125 RED ROCKET	125		1993 →	FRP408		XRAC/ST/PR/PI/CPRO/CP1	FDB207			ST/P/EF/CP1
VITY 125	125		2008 →	FDB2238		P/EF				
WR 125	125		1990 →	FDB497		ST/SM/SG/P/EF	FDB659			SG/P/EF
WR 125	125		1991 → 1992	FDB497		ST/SM/SG/P/EF	FDB659			SG/P/EF
WR 125 R	125		2009 → 2013	FDB570		XRAC/ST/SM/P/EF/CPRO	FDB2005			ST/SG/P/EF
WR 125 X (Supermoto)	125		2009 →	FDB570		XRAC/ST/SM/P/EF/CPRO	FDB2005			ST/SG/P/EF
X-CITY 125	125		2008 →	FDB2225		SM/EF	FDB2074			ST/SM/P/EF/CPRO/AG
XC 125 BELUGA	125		1993 →	FSB772			FSB733			
XC 125 CYGNUS T	125		1995 →	FSB947			FSB731			
XC 125 CYGNUS	125		1996 → 1997	FDB383		SG/P/EF	FSB731			
XC 125 TR CYGNUS R	125		1998 → 2003	FDB475		AG				
Xenter 125 (SE59)	125	9	2012 →	FDB2264		EF	FSB967			
XN 125 N TEO'S	125		2000 → 2003	FDB889		ST/EF	FSB947			
XQ 125 N MAXSTER	125		2001 → 2003	FDB2018		ZR/ST/SG/P/EF	FDB2074			ST/SM/P/EF/CPRO/AG
XT 125	125		1976 →	FSB913			FSB738			
XT 125 R	125		2008 →	FDB2128		EF	FDB2128			EF
XT 125 X	125		2008 →	FDB677		P/EF	FDB2128			EF
XV 125 VIRAGO	125		1997 → 2000	FDB2003		ST/SM/P/EF	FSB947			
XVS 125 DRAG STAR	125		2000 →	FDB2003		ST/SM/P/EF	FSB947			
YBR 125 E/K (5HH1/2/C/G/J/SLX/SLX9)	125		2000 → 2008	FSB947			FSB947			
YBR 125 ED (3D91)	125		2005 → 2006	FDB383		SG/P/EF	FSB947			
YBR 125 ED (5HHB/F/H)	125		2006 → 2008	FDB497		ST/SM/SG/P/EF	FSB947			
YBR 125 (3D92/9)	125		2007 → 2009	FDB2238		P/EF				
YBR 125 Custom	125		2008 → 2013	FDB2238		P/EF				
YBR 125 (51D1/2)	125		2010 → 2014	FDB2238		P/EF				
YBX	125		1998 → 2000	FSB977			FSB977			
YP 125 MAJESTY (SE02)	125		1998 → 2000	FDB2018		ZR/ST/SG/P/EF	FSB947			
YP 125 MAJESTY (SE06)	125		2001 → 2009	FDB2018		ZR/ST/SG/P/EF	FDB2074			ST/SM/P/EF/CPRO/AG
YP 125 MAJESTY	125		2015 →	FDB2208		EF				
YP 125 R X-MAX (Brembo Front) NO ABS	125		2006 → 2009	FDB2208		EF	FDB2074			ST/SM/P/EF/CPRO/AG
YP 125 R X-MAX (Nissin Front) NO ABS	125		2010 → 2013	FDB2225		SM/EF	FDB2074			ST/SM/P/EF/CPRO/AG
YP 125 RA X-MAX (Nissin Front) (39D2) ABS	125		2011 →	FDB2225		SM/EF	FDB2083			ST/SM/P/EF
YP 125 R X-MAX (Nissin Front) NO ABS	125		2014 →	FDB2225		SM/EF	FDB2279			AG
YP125RA X-MAX IRON MAX ABS	125		2016 →	FDB2225		SM/EF	FDB2083			ST/SM/P/EF
YW 125 X (1DN1/2)	125		2010 → 2013	FDB2284		EF	FSB967			
YZ 125 C - D - E - F - G - H - J	125		1976 → 1982	FSB913			FSB733			
YZ 125 K - N - L	125		1983 → 1984	FSB763			FSB737			
YZ 125	125		1985 → 1987	FDB411		P	FSB737			
YZ 125	125		1988 →	FDB411		P	FDB383			SG/P/EF
YZ 125	125		1989 →	FDB497		ST/SM/SG/P/EF	FDB661			SG/P
YZ 125 all models	125		1990 → 1997	FDB497		ST/SM/SG/P/EF	FDB659			SG/P/EF
YZ 125 all models	125		1998 → 2002	FDB892		ZR/SG/P/EF/CPRO	FDB539			SG/P/EF
YZ 125	125		2003 → 2007	FDB892		ZR/SG/P/EF/CPRO	FDB2162			SG/P/EF
YZ 125	125		2008 →	FDB2219		ZR/SG	FDB2162			SG/P/EF
YZF-R 125	125		2008 → 2013	FDB2018		ZR/ST/SG/P/EF	FDB2184			SG/P
YZF-R 125	125		2014 → 2018	FDB2216		ST/SM/P/CP1	FDB2184			SG/P
YZF-R 125	125		2019 →	FDB2216		ST/SM/P/CP1	FDB659			SG/P/EF
CRYPTON T135	135		2006 →	FDB2238		P/EF	FSB733			
RX135	135		1998 → 2005	FSB977			FSB977			
Fazer	150		2009 →	FDB2018		ZR/ST/SG/P/EF	FSB974			
150 FLY ONE	150		1992 →	FDB383		SG/P/EF	FSB704			
FZ1	150		2009 →	FDB2018		ZR/ST/SG/P/EF	FSB974			
MAXTER 150	150		2001 → 2003	FDB680		ST/EF	FDB2074			ST/SM/P/EF/CPRO/AG
Xenter 150	150		2012 →	FDB2264		EF	FSB967			
YP 150 MAJESTY	150		2001 → 2003	FDB2018		ZR/ST/SG/P/EF	FDB2074			ST/SM/P/EF/CPRO/AG
YZF-R15 (Indian Model)	150		2008 →	FDB2238		P/EF	FDB2143			P/EF
YZF-R15	150		2011 →	FDB2238		P/EF	FDB2143			P/EF
NMAX	155	11	2019 →	FDB2290		EF	FDB2238			P/EF
Tricity 155 ABS	155		2018 →	FDB2296	left	EF				
Tricity 155 ABS	155		2018 →	FDB2297	right	EF	FDB2238	right		P/EF
DT 175 MX	175		1974 → 1983	FSB733			FSB733			
IT 175 G - H - I	175		1980 → 1982	FSB913			FSB733			
TY 175	175		1977 → 1980	FSB732			FSB733			

* It is recommended that in those applications where sintered pads are supplied as Original Equipment, replacement pads should also be of sintered composition.

** To avoid brake imbalance sintered pads fitted in rear calipers should only be used in combination with front calipers containing sintered pads.



CC KW FROM -> TO N° SET L/R COMPOUND N° SET L/R COMPOUND

...YAMAHA									
CC	KW	FROM ->	TO	N° SET	L/R	COMPOUND	N° SET	L/R	COMPOUND
RT 180	180	1990	→ 1992	FDB583		P	FSB733		
RT 180	180	1993	→ 1994	FDB583		P	FSB947		
RT 180 G	180	1995	→ 2000	FDB475		AG	FSB947		
XC 180 GYGNUS	180	1983	→ 1985	FSB733			FSB734		
XC 185 BELUGA	185	1993	→	FSB772			FSB772		
DT 200 R	200	1988	→ 1991	FDB475		AG	FDB475		AG
DT 200 WR	200	1991	→	FDB497		ST/SM/SG/P/EF	FDB659		SG/P/EF
IT 200	200	1984	→	FSB737			FSB737		
RD 200 DX	200	1975	→ 1978				FSB734		
RS 200 C	200	1975	→ 1980				FSB734		
RS 200	200	1979	→	FSB734			FSB734		
SDR 200	200	1987	→ 1989	FDB386		ST/P/EF	FDB386		ST/P/EF
TW 200 T/U/W	200	1987	→ 1988	FSB734			FSB732		
TW 200	200	1989	→ 1992	FSB733			FSB731		
TW 200	200	1993	→ 2000	FSB947			FSB731		
TW 200	200	2001	→ 2003	FDB383		SG/P/EF	FSB731		
WR 200 B	200	1991	→ 1994	FDB497		ST/SM/SG/P/EF	FDB659		SG/P/EF
BRONCO 225	225	1997	→	FDB2083		ST/SM/P/EF			
CELLOW 225	225	1997	→	FDB2083		ST/SM/P/EF			
CELLOW 225	225	2005	→	FDB2208		EF			
SEROW 225 XT	225	1985	→ 1992	FDB383		SG/P/EF	FSB731		
SEROW 225 XT	225	1993	→ 1995	FDB383		SG/P/EF	FDB659		SG/P/EF
TT-R 225	225	1999	→ 2002	FDB383		SG/P/EF	FSB731		
XV 240 VIRAGO	240	1991	→ 1992	FDB311		P	FSB733		
XV 240 VIRAGO	240	1992	→ 2000	FDB311		P			
FZ 25	249	2018	→	FDB2018		ZR/ST/SG/P/EF			
CP 250 (1B71) Maxam/Morphus	250	2005	→ 2008	FDB2003		ST/SM/P/EF	FDB2200		SM/P/EF
CYGNUS X 250	250	2007	→	FDB2224		P/EF			
DT 250 MX	250	1975	→ 1980	FSB767			FSB734		
FZR 250	250	1986	→ 1988	FDB449	2	ST/P	FDB386		ST/P/EF
FZR 250 R	250	1989	→	FDB605		ZRAC/XRAC/ST/SM/P/EF/CPRO	FDB386		ST/P/EF
FZX 250 ZEAL	250	1991	→	FDB781		ST/P/EF	FDB386		ST/P/EF
IT 250 G	250	1980	→	FSB913			FSB767		
IT 250 H - J - K	250	1981	→ 1983	FSB913			FSB734		
IT 250 L	250	1984	→	FSB763			FSB734		
R1 250 Z	250	1997	→	FDB449	2	ST/P	FDB386		ST/P/EF
RD 250 A - B - C	250	1974	→ 1977				FSB735		
RD 250 E - F	250	1978	→ 1979	FDB184		P	FDB184		P
RD 250 LC	250	1980	→				FSB735		
RD 250 LC	250	1981	→ 1983	FDB277		P	FSB735		
RZR 250	250	1990	→	FDB386	2	ST/P/EF	FDB386		ST/P/EF
SEROW 250 (3C51/52)	250	2005	→	FDB2083		ST/SM/P/EF	FDB659		SG/P/EF
SR 250	250	1987	→	FSB766			FSB733		
SR 250 E (Espana)	250	1990	→ 1994	FDB311		P	FSB733		
SR 250 SE	250	1980	→ 1982	FSB767			FSB733		
SRV 250 SOULFULTWIN RENAISSA	250	1992	→ 1997	FDB781		ST/P/EF	FSB947		
TDR 250	250	1988	→ 1992	FDB449		ST/P	FDB386		ST/P/EF
TT 250 R	250	1993	→ 1999	FDB497		ST/SM/SG/P/EF	FDB659		SG/P/EF
TT 250 S	250	1987	→ 1992	FDB411		P	FSB733		
TT-R 250	250	2000	→	FDB497		ST/SM/SG/P/EF	FDB539		SG/P/EF
TY 250 D - E - F - G	250	1977	→ 1980	FSB732			FSB733		
TY 250 H	250	1981	→ 1983	FSB913			FSB734		
TY 250 R	250	1991	→ 1993	FRP405		ST/SG/PRP/P/EF	FSB732		
TY 250 S - RS	250	1984	→ 1990	FSB737			FSB732		
TY 250 Z	250	1993	→ 1995	FDB2107		P	FDB2107		P
TY 250 Z SCOTTISH	250	1996	→	FDB781		ST/P/EF	FDB659		SG/P/EF
TZ 250	250	1985	→ 1988	FDB449		ST/P	FDB386		ST/P/EF
TZ 250	250	1989	→ 2001	FDB557	2	XRAC/ST/P/EF/CP1	FDB2194		P
TZ 250	250	2002	→ 2008	FDB2158	2	ST	FDB2194		P
TZR 250	250	1985	→ 1989	FDB449		ST/P	FDB386		ST/P/EF
TZR 250 R - SP	250	1989	→ 1992	FDB557	2	XRAC/ST/P/EF/CP1	FDB386		ST/P/EF
TZR 250 R	250	1994	→	FRP408	2	XRAC/ST/PRP/P/CPRO/CP1	FDB2194		P
WR 250 (Z 2T)	250	1991	→ 1997	FDB497		ST/SM/SG/P/EF	FDB659		SG/P/EF
WR 250 (ZK 2T - FN&FT 4T)	250	1998	→ 2002	FDB892		ZR/SG/P/EF/CPRO	FDB539		SG/P/EF
WR 250 F (4T)	250	2003	→ 2016	FDB892		ZR/SG/P/EF/CPRO	FDB2162		SG/P/EF
WR 250 R (32D1/3)	250	2008	→ 2010	FDB892		ZR/SG/P/EF/CPRO	FDB2162		SG/P/EF
WR 250 X (Supermotard) (32D2/4)	250	2008	→ 2010	FDB570		XRAC/ST/SM/P/EF/CPRO	FDB2162		SG/P/EF
WR 250 F	250	2017	→	FDB892		ZR/SG/P/EF/CPRO	FDB2162		SG/P/EF
X-CITY 250	250	2008	→	FDB2225		SM/EF	FDB2083		ST/SM/P/EF
XG 250 TRICKER (5XT1)	250	2004	→ 2006	FDB2083		ST/SM/P/EF	FDB659		SG/P/EF
XL 250 G	250	1980	→	FSB913			FSB733		
X-Max 250 (SG16) - No ABS	250	15	2005 → 2009	FDB2208		EF	FDB2083		ST/SM/P/EF
X-Max 250 (SG16) - No ABS	250	16	2007 → 2009	FDB2208		EF	FDB2083		ST/SM/P/EF
X-Max 250 (SG22)	250	15	2010 → 2013	FDB2225		SM/EF	FDB2083		ST/SM/P/EF

* It is recommended that in those applications where sintered pads are supplied as Original Equipment, replacement pads should also be of sintered composition.

** To avoid brake imbalance sintered pads fitted in rear calipers should only be used in combination with front calipers containing sintered pads.



CC KW FROM -> TO N° SET L/R COMPOUND N° SET L/R COMPOUND

...YAMAHA									
X-Max 250 ABS (SG22)	250	15	2011 →	FDB2225			SM/EF	FDB2083	ST/SM/P/EF
X-Max 250 (SG22)	250		2014 →	FDB2225			SM/EF	FDB2279	AG
X-Max 250 Momodesign (SG22)	250	15	2015 →	FDB2225			SM/EF	FDB531	ST/P/EF
X-Max IRON MAX ABS	250		2016 →	FDB2225			SM/EF	FDB2083	ST/SM/P/EF
XS 250	250		1978 → 1978	FDB177			P	FDB177	P
XS 250 C	250		1980 →	FSB770				FSB736	
XS 250 D - E	250		1979 → 1981	FDB177			P	FSB736	
XS 250 SE - SF SPECIAL	250		1979 → 1981	FDB184			P	FSB736	
XT 250	250		1980 →	FSB733				FSB733	
XT 250 X	250		2006 → 2008	FDB2083			ST/SM/P/EF	FDB659	SG/P/EF
XV 250 VIRAGO	250		1993 → 1994	FDB311			P	FSB733	
XV 250 S VIRAGO	250		1995 → 2000	FDB2003			ST/SM/P/EF	FSB947	
XVS 250 DRAGSTAR	250		2001 → 2004	FDB2003			ST/SM/P/EF	FSB947	
YBR 250	250	15	2006 → 2013	FDB631			ST/SM/SG/P/EF/AG		
YD 250 S	250		1991 →	FDB337			ST/P/EF	FSB767	
YP 250 MAJESTY	250		1996 → 1997	FDB2003			ST/SM/P/EF	FSB736	
YP 250 A MAJESTY	250		2000 →	FDB2003			ST/SM/P/EF	FDB2083	ST/SM/P/EF
YP 250 MAJESTY DX - ABS	250		1998 → 1999	FDB2003			ST/SM/P/EF	FDB2083	ST/SM/P/EF
YZ 250 D - E - F	250		1976 → 1979	FSB913				FSB767	
YZ 250 G	250		1980 →	FSB913				FSB733	
YZ 250 H	250		1981 →	FSB913				FSB734	
YZ 250 J - K - L	250		1982 → 1984	FSB763				FSB733	
YZ 250	250		1985 → 1987	FDB411			P	FSB733	
YZ 250	250		1988 →	FDB411			P	FDB383	SG/P/EF
YZ 250	250		1989 →	FDB497			ST/SM/SG/P/EF	FDB661	SG/P
YZ 250	250		1990 → 1997	FDB497			ST/SM/SG/P/EF	FDB659	SG/P/EF
YZ 250 A - B	250		1990 → 1992	FDB497			ST/SM/SG/P/EF	FDB659	SG/P/EF
YZ 250	250		1995 → 1997	FDB497			ST/SM/SG/P/EF		
YZ 250 K/L/M	250		1998 → 2000	FDB892			ZR/SG/P/EF/CPRO	FDB539	SG/P/EF
YZ 250 FN-FP (4T)	250		2001 → 2002	FDB892			ZR/SG/P/EF/CPRO	FDB539	SG/P/EF
YZ 250 N-P (2T)	250		2001 → 2002	FDB892			ZR/SG/P/EF/CPRO	FDB539	SG/P/EF
YZ 250 (2T)	250		2003 → 2007	FDB892			ZR/SG/P/EF/CPRO	FDB2162	SG/P/EF
YZ 250 F (4T)	250		2003 → 2006	FDB892			ZR/SG/P/EF/CPRO	FDB2162	SG/P/EF
YZ 250 F (4T)	250		2007 →	FDB2219			ZR/SG	FDB2162	SG/P/EF
YZ 250 (2T)	250		2008 →	FDB2219			ZR/SG	FDB2162	SG/P/EF
YZ 250 F 60th Anniv.	250		2016 →	FDB2219			ZR/SG	FDB2162	SG/P/EF
YZF-R25 (RG10)	250	26	2015 →	FDB2280			ST/EF/CPRO/CP1	FDB2283	EF
Tricity 300	300		2020 →	FDB2296		left	EF		
Tricity 300	300		2020 →	FDB2297		right	EF		
Tricity 300	300		2020 →					FDB2238	P/EF
VERSITY 300	300		2004 →	FDB2018			ZR/ST/SG/P/EF	FDB2018	ZR/ST/SG/P/EF
X-Max 300 Iron Max	300	20	2019 →	FDB2280			ST/EF/CPRO/CP1	FDB2083	ST/SM/P/EF
X-Max 300 ABS	300		2017 →	FDB2280			ST/EF/CPRO/CP1	FDB2283	EF
MT-03 ABS	321		2016 →	FDB2280			ST/EF/CPRO/CP1	FDB2283	EF
YZF-R3	321		2015 →	FDB2280			ST/EF/CPRO/CP1	FDB2283	EF
RD 350 YPVS	350		1983 → 1984	FDB311	2		P	FDB337	ST/P/EF
RD 350 all models	350		1985 → 1995	FDB386	2		ST/P/EF	FDB386	ST/P/EF
RD 350 A - B	350		1974 → 1976					FSB735	
RD 350 LC	350		1980 →					FSB735	
RD 350 LC	350		1981 → 1982	FDB277	2		P	FSB735	
RD 350 S	350		1974 → 1976					FSB735	
TT 350	350		1986 → 1990	FDB411			P	FSB733	
TT 350	350		1991 → 1995	FDB411			P	FDB383	SG/P/EF
XT 350 4 VALVES	350		1985 →	FDB311			P	FSB734	
XT 350 4 VALVES	350		1986 → 1987	FDB475			AG	FSB733	
XT 350	350		1988 → 1990	FDB583			P	FSB733	
XT 350	350		1991 →	FDB583			P	FSB733	
XT 350	350		1992 → 1995	FDB383			SG/P/EF	FSB733	
XS 360 B	360		1975 → 1975					FSB735	
XS 360 C	360		1976 →	FDB177			P	FDB177	P
YZ 360	360		1989 →	FDB497			ST/SM/SG/P/EF	FDB661	SG/P
400 ARTESIA	400		1991 →	FDB737			P	FDB383	SG/P/EF
DT 400 MX	400		1975 → 1977	FSB767				FSB734	
FZ 400	400		1986 →	FDB337	2		ST/P/EF	FDB386	ST/P/EF
FZR 400 R	400		1987 → 1990	FDB449	2		ST/P	FDB337	ST/P/EF
FZR 400 RR - SP	400		1991 → 1992	FDB605	2		ZRAC/XRAC/ST/SM/P/EF/CPRO	FDB386	ST/P/EF
RD 400 E - F	400		1978 →	FDB184			P	FDB184	P
SR 400	400		1977 → 1984	FDB177			P	FDB177	P
SR 400 (3HT1)	400		1985 → 2000					FSB734	
SR 400 (BC-RH01J)	400		2001 →	FDB781			ST/P/EF	FSB734	
SR 400 (RH051)	400		2014 →	FDB781			ST/P/EF	FSB734	
SRX 400	400		1985 → 1986	FDB337			ST/P/EF	FDB386	ST/P/EF
SRX 400	400		1987 → 1989	FDB449			ST/P	FDB386	ST/P/EF
SRX 400	400		1990 → 1996	FDB666			ST/P	FDB337	ST/P/EF

* It is recommended that in those applications where sintered pads are supplied as Original Equipment, replacement pads should also be of sintered composition.

** To avoid brake imbalance sintered pads fitted in rear calipers should only be used in combination with front calipers containing sintered pads.



CC KW FROM -> TO N° SET L/R COMPOUND



N° SET L/R COMPOUND

...YAMAHA											
Model	CC	KW	FROM -> TO	FDB	N° SET	L/R	COMPOUND	FDB	N° SET	L/R	COMPOUND
WR 400 F	400	1998	→	FDB892			ZR/SG/P/EF/CPRO	FDB659			SG/P/EF
WR 400 F	400	1999	→ 2001	FDB892			ZR/SG/P/EF/CPRO	FDB539			SG/P/EF
XJ 400 DIVERSION - R	400	1991	→ 1994	FDB2003			ST/SM/P/EF	FDB386			ST/P/EF
XJR 400 R	400	1997	→	FDB2003			ST/SM/P/EF	FDB337			ST/P/EF
X-Max 400	400	23	2013 →	FDB2225			SM/EF	FDB2254			EF
X-Max 400 ABS	400	23	2013 →	FDB2225			SM/EF	FDB2254			EF
X-Max 400RA IRON MAX ABS	400		2016 →	FDB2225	2		SM/EF	FDB2254			EF
XS 400	400	1979	→ 1979	FDB177			P	FSB736			
XS 400 SE	400	1980	→ 1981	FDB184			P	FSB736			
XS 400 DOHC	400	1982	→	FDB311			P	FSB736			
XS 400 SPECIAL	400	1982	→	FDB311			P	FSB736			
XV 400 VIRAGO	400	1988	→	FDB591			P	FSB765			
XVS 400	400	1998	→ 1999	FDB781			ST/P/EF	FDB765			
YP 400 MAJESTY	400	2004	→ 2004	FDB781	2		ST/P/EF	FDB2200			SM/P/EF
YP 400 MAJESTY (NO ABS)	400	2005	→	FDB2003	2		ST/SM/P/EF	FDB2200			SM/P/EF
YP 400 MAJESTY (ABS)	400	2007	→	FDB2003	2		ST/SM/P/EF	FDB2200			SM/P/EF
YZ 400 D - E - F	400	1977	→ 1979	FSB913				FSB767			
YZ 400 F	400	1998	→	FDB892			ZR/SG/P/EF/CPRO	FDB539			SG/P/EF
IT 425 G	425	1980	→	FSB913				FSB767			
WR 426 FN	426	2001	→ 2002	FDB892			ZR/SG/P/EF/CPRO	FDB539			SG/P/EF
YZ 426 FM / FN	426	2000	→ 2002	FDB892			ZR/SG/P/EF/CPRO	FDB539			SG/P/EF
WR 450 F	450	2003	→	FDB892			ZR/SG/P/EF/CPRO	FDB2162			SG/P/EF
WR 450 F	450	2019	→	FDB2219			ZR/SG	FDB2162			SG/P/EF
YZ 450 F	450	2003	→ 2007	FDB892			ZR/SG/P/EF/CPRO	FDB2162			SG/P/EF
YZ 450 F	450	2008	→	FDB2219			ZR/SG	FDB2162			SG/P/EF
YZ 450 F 60th Anniv.	450	2016	→	FDB2219			ZR/SG	FDB2162			SG/P/EF
YZ 450 F	450	2020	→	FDB2323			ZR/SG	FDB2162			SG/P/EF
IT 465 H - I	465	1981	→ 1982	FSB763				FSB734			
YZ 465 G - H - J - U	465	1980	→	FSB763				FSB734			
IT 490 L	490	1983	→ 1984	FSB763				FSB733			
YZ 490	490	1985	→ 1987	FDB411			P	FSB734			
YZ 490 J	490	1982	→ 1982	FSB763				FSB734			
YZ 490 K - L	490	1983	→ 1984	FSB763				FSB733			
IT 500 G - H	500	1980	→ 1981	FSB913				FSB767			
RD 500 LC	500	1984	→ 1986	FDB337	2		ST/P/EF	FDB386			ST/P/EF
RD 500 YPVS LC	500	1984	→ 1987	FDB337	2		ST/P/EF	FDB386			ST/P/EF
SR 500	500	1978	→ 1982	FDB177			P	FSB734			
SR 500	500	1993	→					FSB734			
TMAX 500 (5SJ1)	500	29	2001 → 2003	FDB781			ST/P/EF	FDB2126			SM/P/EF
TMAX 500 (SJ03)	500	33	2004 → 2007	FDB2003	2		ST/SM/P/EF	FDB2200			SM/P/EF
TMAX 500 (SJ05)	500	32	2008 → 2011	FDB605	2		ZRAC/XRAC/ST/SM/P/EF/CPRO	FDB2200			SM/P/EF
TMAX 500 SV (Tech Max)	500	2011	→	FDB605	2		ZRAC/XRAC/ST/SM/P/EF/CPRO	FDB2200			SM/P/EF
TMAX 500 SV ABS (Tech Max)	500	2011	→	FDB605	2		ZRAC/XRAC/ST/SM/P/EF/CPRO	FDB2200			SM/P/EF
TT 500 G - H	500	1976	→ 1981	FSB913				FSB767			
TX 500	500	1975	→ 1977					FSB769			
WR 500 B	500	1991	→ 1992	FDB497			ST/SM/SG/P/EF	FDB383			SG/P/EF
WR 500 ZD - ZE	500	1992	→ 1993	FDB497			ST/SM/SG/P/EF	FDB659			SG/P/EF
XS 500 B	500	1975	→ 1977					FSB769			
XS 500 C	500	1976	→ 1979	FDB177			P	FDB177			P
XT 500	500	1976	→ 1981	FSB767				FSB734			
XT 500 (Austria)	500	1983	→	FDB311			P	FSB734			
TMAX 530	530	2012	→	FDB605	2		ZRAC/XRAC/ST/SM/P/EF/CPRO	FDB2126			SM/P/EF
TMAX 530 ABS	530	2012	→	FDB605	2		ZRAC/XRAC/ST/SM/P/EF/CPRO	FDB2126			SM/P/EF
TMAX 530 IRON MAX /ABS	530	2015	→	FDB605	2		ZRAC/XRAC/ST/SM/P/EF/CPRO	FDB2126			SM/P/EF
TMAX 530 LUX MAX /ABS	530	2016	→	FDB605	2		ZRAC/XRAC/ST/SM/P/EF/CPRO	FDB2126			SM/P/EF
TMAX 530 DX ABS	530	2017	→	FDB605	2		ZRAC/XRAC/ST/SM/P/EF/CPRO	FDB2126			SM/P/EF
TMAX 530 SX ABS	530	2018	→	FDB605	2		ZRAC/XRAC/ST/SM/P/EF/CPRO	FDB2126			SM/P/EF
TMAX 530 SX ABS SPORT EDITION	530	2018	→	FDB605	2		ZRAC/XRAC/ST/SM/P/EF/CPRO	FDB2126			SM/P/EF
XV 535 VIRAGO	535	1987	→ 1994	FDB591			P	FSB765			
XV 535 VIRAGO	535	1995	→ 1998	FDB781			ST/P/EF	FSB765			
XJ 550	550	1981	→ 1984	FDB277	2		P	FSB769			
XT 550	550	1982	→ 1983	FSB734				FSB734			
XZ 550	550	1982	→ 1984	FDB311	2		P	FSB769			
XZ 550 S	550	1984	→ 1986	FDB311	2		P	FSB769			
TMAX 560	560	2020	→	FDB605	2		ZRAC/XRAC/ST/SM/P/EF/CPRO	FDB2126			SM/P/EF
TMAX 560 Tech	560	2020	→	FDB605	2		ZRAC/XRAC/ST/SM/P/EF/CPRO	FDB2126			SM/P/EF
600 DIVERSION	600	1992	→ 1997	FDB781			ST/P/EF	FDB386			ST/P/EF
FZ 600	600	1987	→ 1988	FDB337	2		ST/P/EF	FDB386			ST/P/EF
FZ6 600 / FZ6 600 FAZER ABS	600	2004	→ 2007	FDB2003	2		ST/SM/P/EF	FDB754			ST/P/EF
FZ6 600 S2 / FZ6 600 FAZER S2 ABS	600	2007	→ 2009	FDB605	2		ZRAC/XRAC/ST/SM/P/EF/CPRO	FDB754			ST/P/EF
FZ6R 600	600	2009	→	FDB2003	2		ST/SM/P/EF	FDB531			ST/P/EF
FZR 600	600	1989	→	FDB337	2		ST/P/EF	FDB337			ST/P/EF
FZR 600 R	600	1990	→	FDB666	2		ST/P	FDB337			ST/P/EF
FZR 600 R	600	1991	→ 1995	FDB637	2		ST/P	FDB337			ST/P/EF

YAMAHA

* It is recommended that in those applications where sintered pads are supplied as Original Equipment, replacement pads should also be of sintered composition.

** To avoid brake imbalance sintered pads fitted in rear calipers should only be used in combination with front calipers containing sintered pads.



CC KW FROM -> TO N° SET L/R COMPOUND N° SET L/R COMPOUND

...YAMAHA

FZS 600 FAZER	600	1999 → 2003	FDB605			ZRAC/XRAC/ST/SM/P/EF/CPRO	FDB386		ST/P/EF
SRX 600	600	1985 → 1987	FDB386	2		ST/P/EF	FDB386		ST/P/EF
SRX 600	600	1988 → 1990	FDB449			ST/P	FDB386		ST/P/EF
TT 600	600	1987 → 1992	FDB475			AG	FSB733		
TT 600	600	1993 →	FDB2018			ZR/ST/SG/P/EF	FDB659		SG/P/EF
TT 600 L	600	1983 → 1984	FSB763				FSB733		
TT 600 N	600	1985 → 1988	FDB311			P	FSB734		
TT 600 N	600	1985 → 2000	FDB411			P	FSB733		
TT 600 R (SPORTKIT)	600	1994 → 1997	FDB2018			ZR/ST/SG/P/EF	FDB659		SG/P/EF
TT 600 R	600	1998 → 1999	FDB2018			ZR/ST/SG/P/EF	FDB2005		ST/SG/P/EF
TT 600 RE	600	2004 →	FDB2018			ZR/ST/SG/P/EF	FDB2005		ST/SG/P/EF
TT-R 600 R	600	2000 → 2003	FDB2018			ZR/ST/SG/P/EF	FDB2005		ST/SG/P/EF
XJ 600 RADIANT	600	1984 → 1991	FDB337	2		ST/P/EF	FDB337		ST/P/EF
XJ 600 S	600	1992 → 1997	FDB781			ST/P/EF	FDB386		ST/P/EF
XJ 600 S	600	1998 → 2003	FDB2003			ST/SM/P/EF	FDB386		ST/P/EF
XJ6-F Diversion 600 (Non ABS&ABS models)	600	2010 → 2013	FDB2003	2		ST/SM/P/EF	FDB531		ST/P/EF
XJ6-F Diversion 600 (Non ABS&ABS models)	600	2013 →	FDB2003	2		ST/SM/P/EF	FDB754		ST/P/EF
XJ6-N Diversion 600 (Non ABS&ABS models)	600	2009 → 2013	FDB2003	2		ST/SM/P/EF	FDB531		ST/P/EF
XJ6-N Diversion 600 (Non ABS&ABS models)	600	2013 →	FDB2003	2		ST/SM/P/EF	FDB754		ST/P/EF
XJ6-S Diversion 600 (Non ABS&ABS models)	600	2009 → 2013	FDB2003	2		ST/SM/P/EF	FDB531		ST/P/EF
XJ6-S Diversion 600 (Non ABS&ABS models)	600	2013 →	FDB2003	2		ST/SM/P/EF	FDB754		ST/P/EF
XJ6-SP Diversion 600 (NON ABS&ABS models)	600	2013 → 2013	FDB2003	2		ST/SM/P/EF	FDB754		ST/P/EF
XT 600 4 VALVES	600	1984 → 1985	FDB311			P	FSB734		
XT 600 4 VALVES	600	1986 → 1986	FDB583			P	FSB733		
XT 600 4 VALVES	600	1987 → 1989	FDB583			P	FDB475		AG
XT 600 E - K	600	1991 → 1994	FDB737			P	FDB383		SG/P/EF
XT 600 E - K	600	1995 → 2003	FDB737			P	FDB383		SG/P/EF
XT 600 Z TENERE	600	1983 → 1984	FDB311			P	FSB734		
XT 600 Z TENERE	600	1985 → 1987	FDB583			P	FSB733		
XT 600 Z TENERE	600	1988 → 1990	FDB583			P	FDB475		AG
XT 600 Z TENERE	600	1991 →	FDB737			P	FDB383		SG/P/EF
YZF 600 R THUNDERCAT	600	1996 → 2003	FDB605	2		ZRAC/XRAC/ST/SM/P/EF/CPRO	FDB337		ST/P/EF
YZF 600 R6	600	1999 → 2002	FDB605	2		ZRAC/XRAC/ST/SM/P/EF/CPRO	FDB2083		ST/SM/P/EF
YZF 600 R6	600	2003 → 2004	FDB605	2		ZRAC/XRAC/ST/SM/P/EF/CPRO	FDB754		ST/P/EF
YZF 600 R6	600	2005 → 2016	FDB605	2		ZRAC/XRAC/ST/SM/P/EF/CPRO	FDB754		ST/P/EF
YZF 600 R6	600	2017 → 2019	FDB605	2		ZRAC/XRAC/ST/SM/P/EF/CPRO	FDB2221		ST/P
KJ 650	650	1980 →	FDB177	2		P	FSB765		
XJ 650 TURBO	650	1983 →	FDB311	2		P	FSB765		
XS 650	650	1975 → 1976					FSB735		
XS 650	650	1977 → 1981	FDB177	2		P	FSB735		
XS 650 SE	650	1979 → 1980	FDB177			P	FDB177		P
XS 650 SE	650	1981 →	FDB177			P	FSB735		
XVS 650 DRAG STAR	650	1997 →	FDB781			ST/P/EF	FSB765		
XVS 650 A DRAG STAR CLASSIC	650	1998 →	FDB781			ST/P/EF	FSB765		
MT-03 660	660	2008 →	FDB2003	2		ST/SM/P/EF	FDB2005		ST/SG/P/EF
SZR 660	660	1996 → 1997	FRP408			XRAC/ST/PRP/CPRO/CP1	FDB207		ST/P/EF/CP1
XT 660 R	660	2004 →	FDB2006			ST/P/EF	FDB2005		ST/SG/P/EF
XT 660 X Supermoto	660	2004 →	FDB2042			ZRAC/XRAC/ST/P/EF/CPRO	FDB2005		ST/SG/P/EF
XT 660 Z TENERE (Non ABS)	660	2008 →	FDB2018	2		ZR/ST/SG/P/EF	FDB2005		ST/SG/P/EF
XT 660 ZA TENERE (ABS)	660	2011 → 2011	FDB2018	2		ZR/ST/SG/P/EF	FDB2005		ST/SG/P/EF
XTZ 660 TENERE	660	1991 → 1998	FDB737			P	FDB383		SG/P/EF
Tenere 700	689	54 2019 →	FDB2018	2		ZR/ST/SG/P/EF	FDB2005		ST/SG/P/EF
Tenere 700 World Raid Proto	689	2018 →	FDB2018	2		ZR/ST/SG/P/EF	FDB2005		ST/SG/P/EF
Tracer 700 ABS	689	55 2018 →	FDB605	2		ZRAC/XRAC/ST/SM/P/EF/CPRO	FDB754		ST/P/EF
MT-07 (RM04)	700	34 2014 →	FDB605	2		ZRAC/XRAC/ST/SM/P/EF/CPRO	FDB754		ST/P/EF
MT-07 (RM04)	700	55 2014 →	FDB605	2		ZRAC/XRAC/ST/SM/P/EF/CPRO	FDB754		ST/P/EF
MT-07 Motocage ABS	700	2015 →	FDB605	2		ZRAC/XRAC/ST/SM/P/EF/CPRO	FDB754		ST/P/EF
Tracer 700 GT	700	55 2019 →	FDB605	2		ZRAC/XRAC/ST/SM/P/EF/CPRO	FDB754		ST/P/EF
Tracer 700	700	2020 →	FDB605	2		ZRAC/XRAC/ST/SM/P/EF/CPRO	FDB754		ST/P/EF
XSR 700 ABS (RM11)	700	35 2016 →	FDB605	2		ZRAC/XRAC/ST/SM/P/EF/CPRO	FDB754		ST/P/EF
XSR 700 ABS (RM11)	700	55 2016 →	FDB605	2		ZRAC/XRAC/ST/SM/P/EF/CPRO	FDB754		ST/P/EF
XSR 700 Xtribute	700	55 2019 →	FDB605	2		ZRAC/XRAC/ST/SM/P/EF/CPRO	FDB754		ST/P/EF
FZ 750	750	1985 → 1986	FDB337	2		ST/P/EF	FDB337		ST/P/EF
FZ 750 GENESIS	750	1987 → 1988	FDB337	2		ST/P/EF	FDB337		ST/P/EF
FZ 750 GENESIS	750	1989 → 1992	FDB449	2		ST/P	FDB337		ST/P/EF
FZR 750 GENESIS	750	1987 →	FDB449	2		ST/P	FDB337		ST/P/EF
FZR 750 (Q W01)	750	1989 → 1991	FDB557	2		XRAC/ST/P/EF/CP1	FDB337		ST/P/EF
FZX 750	750	1987 →	FDB337	2		ST/P/EF	FDB337		ST/P/EF
XJ 750	750	1982 → 1984	FDB277			P	FSB765		
XJ 750 F	750	1984 →	FDB337	2		ST/P/EF	FDB337		ST/P/EF
XS 750	750	1977 → 1979	FDB177	2		P	FDB177		P
XS 750 SE - SG	750	1979 → 1980	FDB247			P	FDB177		P
XTZ 750 SUPER TENERE	750	1989 →	FDB497		left	ST/SM/SG/P/EF			
XTZ 750 SUPER TENERE	750	1989 →	FDB631		right	ST/SM/SG/P/EF/AG			

* It is recommended that in those applications where sintered pads are supplied as Original Equipment, replacement pads should also be of sintered composition.

** To avoid brake imbalance sintered pads fitted in rear calipers should only be used in combination with front calipers containing sintered pads.



CC KW FROM -> TO  N° SET L/R COMPOUND



N° SET L/R COMPOUND

...YAMAHA

FJ 1200	1200	1988	→ 1989	FDB662	2		P	FDB337			ST/P/EF
FJ 1200 W - WC	1200	1989	→ 1991	FDB449	2		ST/P	FDB337			ST/P/EF
FJ 1200 ABS	1200	1991	→ 1995	FDB662	2		P	FDB337			ST/P/EF
FJ 1200	1200	1999	→	FDB2003	2		ST/SM/P/EF	FDB337			ST/P/EF
XJR 1200	1200	1994	→	FDB662	2		P	FDB337			ST/P/EF
XJR 1200	1200	1995	→ 1998	FDB2042	2		ZRAC/XRAC/ST/P/EF/CPRO	FDB337			ST/P/EF
XT 1200 ZE ABS (Supertenere)	1200	2014	→	FDB605	2		ZRAC/XRAC/ST/SM/P/EF/CPRO	FDB2156			ST/P/EF
XT 1200 ZE ABS Worldcrosser (Supertenere)	1200	2016	→	FDB605	2		ZRAC/XRAC/ST/SM/P/EF/CPRO	FDB2156			ST/P/EF
XT 1200 Z Super Tenere' (DP01) ABS	1200	81	2010 → 2013	FDB605	2		ZRAC/XRAC/ST/SM/P/EF/CPRO	FDB2156			ST/P/EF
XT 1200 Z Super Tenere' ABS	1200	82	2014 →	FDB605	2		ZRAC/XRAC/ST/SM/P/EF/CPRO	FDB2156			ST/P/EF
XT 1200 Z Super Tenere' ABS Worldcrosser	1200	2016	→	FDB605	2		ZRAC/XRAC/ST/SM/P/EF/CPRO	FDB2156			ST/P/EF
XVZ 1200 12 T TD	1200	1985	→ 1987	FDB337	2		ST/P/EF	FDB337			ST/P/EF
YMX 1200 12N V-MAX	1200		→ 1992	FDB337	2		ST/P/EF	FDB337			ST/P/EF
YMX 1200 12N V-MAX	1200	1993	→ 2003	FDB666	2		ST/P	FDB337			ST/P/EF
FJR 1300	1300	2001	→ 2002	FDB605	2		ZRAC/XRAC/ST/SM/P/EF/CPRO	FDB2156			ST/P/EF
FJR 1300/FJR 1300 A	1300	2003	→ 2005	FDB605	2		ZRAC/XRAC/ST/SM/P/EF/CPRO	FDB2156			ST/P/EF
FJR 1300A (ABS - 4 pad Front caliper)	1300	2006	→	FDB2085	2		ST/SM/P/EF	FDB2156			ST/P/EF
FJR 1300AS (ABS - Electric gearshift)	1300	2006	→	FDB2085	2		ST/SM/P/EF	FDB2156			ST/P/EF
FJR 1300AE (ABS - Electronic suspension adj)	1300	2015	→	FDB2085	2		ST/SM/P/EF	FDB2156			ST/P/EF
XJR 1300 SP	1300	1999	→ 2001	FDB605	2		ZRAC/XRAC/ST/SM/P/EF/CPRO	FDB337			ST/P/EF
XJR 1300	1300	2001	→	FDB605	2		ZRAC/XRAC/ST/SM/P/EF/CPRO	FDB2150			ST
XJR 1300	1300	2015	→	FDB605	2		ZRAC/XRAC/ST/SM/P/EF/CPRO	FDB337			ST/P/EF
XJR1300 Racer	1300	2015	→	FDB605	2		ZRAC/XRAC/ST/SM/P/EF/CPRO	FDB337			ST/P/EF
XVS 1300 A Midnight Star (VP26)	1300	2007	→	FDB2003	2		ST/SM/P/EF	FDB2156			ST/P/EF
XVS 1300 A CFD	1300	2014	→	FDB2003	2		ST/SM/P/EF	FDB2156			ST/P/EF
XVS 1300 Custom (VP36)	1300	2014	→	FDB781			ST/P/EF	FDB2156			ST/P/EF
XVZ 1300 AH/ATH ROYAL STAR	1300	1996	→ 2001	FDB662	2		P	FDB449			ST/P
XVZ 1300 TF VENTURE STAR	1300	1999	→ 2001	FDB781	2		ST/P/EF	FDB449			ST/P
XV 1600 A WILD STAR	1600	1999	→	FDB781	2		ST/P/EF	FDB449			ST/P
MT-01	1670	2005	→ 2006	FDB605	2		ZRAC/XRAC/ST/SM/P/EF/CPRO	FDB570			XRAC/ST/SM/P/EF/CPRO
MT-01	1670	2007	→	FDB2217	2		ZRAC/XRAC/ST/CPRO/CP1	FDB570			XRAC/ST/SM/P/EF/CPRO
V-MAX	1680	2009	→	FDB2217	2		ZRAC/XRAC/ST/CPRO/CP1	FDB2156			ST/P/EF
XV 1700 ROYAL STAR WARRIOR	1700	2002	→	FDB605	2		ZRAC/XRAC/ST/SM/P/EF/CPRO	FDB2156			ST/P/EF
XV 1900 A Midnight Star	1900	2006	→ 2012	FDB605	2		ZRAC/XRAC/ST/SM/P/EF/CPRO	FDB2156			ST/P/EF
XV 1900 A Midnight Star	1900	2013	→	FDB2085	2		ST/SM/P/EF	FDB2156			ST/P/EF
XV 1900 A CFD	1900	2014	→	FDB2085	2		ST/SM/P/EF	FDB2156			ST/P/EF

ZUNDAPP

KS 50 SPORT	50		→	FDB213			P	FSB835			
KS 50 SUPER SPORT	50		→	FDB213			P	FSB835			
K 80	80	1980	→	FDB205			P				
KS 80	80	1980	→	FDB205			P				
KS 80 SUPER	80	1980	→	FDB207			ST/P/EF/CP1				
KS 80 TOURING K	80	1982	→	FDB436			P				
KS 80 TOURING L	80	1982	→	FDB436			P				
KS 100	100		→	FDB213			P	FSB835			
KS 125	125	1980	→	FDB205			P				
KS 125	125	1982	→	FDB108			ST/P/EF/CPRO				
KS 175	175	1982	→	FDB108			ST/P/EF/CPRO				
SUPER COMBINETTE 429	429		→	FSB836				FSB836			
SUPER COMBINETTE 433	433		→	FSB836				FSB836			
FALCONETTE 435	435		→	FSB836				FSB836			
KS 50 500	500		→	FSB836				FSB836			
KS 75 500	500		→	FSB836				FSB836			

* It is recommended that in those applications where sintered pads are supplied as Original Equipment, replacement pads should also be of sintered composition.

** To avoid brake imbalance sintered pads fitted in rear calipers should only be used in combination with front calipers containing sintered pads.

1110

FERODO[®]

PADS & SHOES

ATV & SNOWMOBILE APPLICATIONS



FERODO[®]

MOTORCYCLE



CC KW FROM -> TO N° SET L/R COMPOUND N° SET L/R COMPOUND

ADLY ATV

Interceptor 300	300	2006 →	FDB313	2		SG/P/EF	FDB313			SG/P/EF
300 Utility	300	2006 →	FDB313	2		SG/P/EF	FDB313			SG/P/EF

ARCTIC CAT

F-series Diamond Drive		2005 →	FDB2214			SG				
50 DVX (4T)	50	2006 → 2008	FSB753	2			FDB2096			SG/EF
50 Utility	50	2006 → 2008	FSB753	2			FDB2096			SG/EF
50-Y6 Youth (2T)	50	2004 → 2006	FSB753	2			FSB760			
90 DVX	90	2006 → 2010	FSB753	2			FDB2096			SG/EF
90 DVX SE	90	2009 →	FSB753	2			FDB2096			SG/EF
90 Reverse Gear Model	90	2010 → 2012	FSB753	2			FDB2096			SG/EF
90 Utility (2 x 4)	90	2006 → 2010	FSB753	2			FDB2096			SG/EF
90-Y12 Youth (2T-4T)	90	2002 → 2005	FSB753	2			FSB966			
150 Utility 2x4	150	2009 → 2010	FSB753	2			FDB2096			SG/EF
250 2 X 4 Utility	250	2005 → 2009	FDB2303	2		SG	FDB2303			SG
250 4 X 4 Utility	250	2008 →	FDB2303	2		SG	FDB2303			SG
250 (2x4/4x4)	250	1999 → 2004	FDB2175	2		SG	FDB2175			SG
250 DVX	250	2006 → 2008	FDB2184	2		SG/P	FDB2141			SG/EF
250 Utility 2 x 4	250	2006 → 2009	FDB2184	2		SG/P	FDB2184	2		SG/P
300 4 X 4 Utility	300	2005 →	FDB2303	2		SG	FDB2303			SG
300 ATV	300	2010 → 2012	FDB2303	2		SG	FDB2303			SG
300 (2x4/4x4)	300	1998 → 2004	FDB2175	2		SG	FDB2175			SG
300 DVX	300	2009 → 2010	FDB2184	2		SG/P	FDB2141	2		SG/EF
350 ATV	350	2012 →	FDB2303	2		SG	FDB2303			SG
366 4 X 4 Auto Utility	366	2008 → 2009	FDB2303	2		SG	FDB2303			SG
366 SE	366	2010 →	FDB2303	2		SG	FDB2303			SG
375 (Auto)	375	2001 →	FDB2175	2		SG	FDB2175			SG
400 4 X 4 Utility	400	2005 → 2007	FDB2303	2		SG	FDB2303			SG
400 4 X 4 VP Utility	400	2005 → 2006	FDB2303	2		SG	FDB2303			SG
400 4 X 4 Auto LE Utility	400	2005 → 2007	FDB2303	2		SG	FDB2303			SG
400 4 X 4 Auto TBX Utility	400	2005 → 2006	FDB2303	2		SG	FDB2303			SG
400 4 X 4 Auto Utility	400	2005 → 2008	FDB2303	2		SG	FDB2303			SG
400 4 X 4 Auto VP Utility	400	2005 → 2006	FDB2303	2		SG	FDB2303			SG
400 4X Auto TRV Multirider	400	2006 →	FDB2303	2		SG	FDB2303			SG
400 4X Auto TRV Plus Multirider	400	2007 →	FDB2303	2		SG	FDB2303			SG
400 TRV	400	2009 →	FDB2303	2		SG	FDB2303			SG
400 TRV H1	400	2010 →	FDB2303	2		SG	FDB2303			SG
400 (2x4/4x4)	400	1998 → 2004	FDB2175	2		SG	FDB2175			SG
400 DVX	400	2004 → 2008	FDB381	2		SG/P/EF	FDB2016			SG
425i	425	2012 →	FDB2303	2		SG	FDB2303			SG
425i SE	425	2012 →	FDB2303	2		SG	FDB2303			SG
440 (4x4)	440	2002 → 2003	FDB2175	2		SG	FDB2175			SG
450 H1 EFi	450	2010 →	FDB2303	2		SG	FDB2303			SG
450 TRV	450	2011 → 2012	FDB2303	2		SG	FDB2303			SG
450i	450	2011 → 2012	FDB2303	2		SG	FDB2303			SG
450i TRV	450	2011 →	FDB2303	2		SG	FDB2303			SG
XC450i	450	2011 → 2012	FDB2303	2		SG	FDB2303			SG
450i GT	450	2012 →	FDB2303	2		SG	FDB2303			SG
BEAR CAT 450 (2x4/4x4)	450	1996 → 1997	FDB2175	2		SG	FDB2175			SG
BEAR CAT 454 (2x4/4x4)	454	1996 → 2000	FDB2175	2		SG	FDB2175			SG
500 4 x 4 Auto LE Utility	500	2005 → 2006	FDB2303	2		SG	FDB2303			SG
500 4 x 4 Auto TBX Utility	500	2005 → 2006	FDB2303	2		SG	FDB2303			SG
500 4 x 4 Auto TRV Multirider	500	2005 → 2008	FDB2303	2		SG	FDB2303			SG
500 4 x 4 Auto Utility	500	2005 → 2008	FDB2303	2		SG	FDB2303			SG
500 4 x 4 Manual G/Box Utility	500	2005 → 2009	FDB2303	2		SG	FDB2303			SG
500 (4x4,Manual,Auto)	500	1998 → 2004	FDB2175	2		SG	FDB2175			SG
550 Hi EFi	550	2009 → 2010	FDB2303	2		SG	FDB2303			SG
550 Hi EFi LE	550	2009 → 2010	FDB2303	2		SG	FDB2303			SG
550 Hi EFi Prowler	550	2009 →	FDB2303	2		SG	FDB2303			SG
550 TRV EFi	550	2009 → 2010	FDB2303	2		SG	FDB2303			SG
550 TRV EFi LE	550	2009 → 2010	FDB2303	2		SG	FDB2303			SG
550 GT S TRV	550	2010 →	FDB2303	2		SG	FDB2303			SG
550 S	550	2010 →	FDB2303	2		SG	FDB2303			SG
550 S LTD	550	2010 →	FDB2303	2		SG	FDB2303			SG
XT 550	550	2010 → 2011	FDB2303	2		SG	FDB2303			SG
550 GT TRV	550	2011 → 2012	FDB2303	2		SG	FDB2303			SG
550 TRV	550	2011 →	FDB2303	2		SG	FDB2303			SG
550 TRV Cruiser	550	2011 →	FDB2303	2		SG	FDB2303			SG
550i	550	2011 → 2012	FDB2303	2		SG	FDB2303			SG
550i GT	550	2011 → 2012	FDB2303	2		SG	FDB2303			SG
550i GT TRV	550	2011 →	FDB2303	2		SG	FDB2303			SG
550i LTD	550	2011 → 2012	FDB2303	2		SG	FDB2303			SG

* It is recommended that in those applications where sintered pads are supplied as Original Equipment, replacement pads should also be of sintered composition.

** To avoid brake imbalance sintered pads fitted in rear calipers should only be used in combination with front calipers containing sintered pads.

2000

FERODO

RACING

Updated on November 2020

ALL TERRAIN



	CC	KW	FROM -> TO	N° SET	L/R	COMPOUND	N° SET	L/R	COMPOUND
...ARCTIC CAT									
550i TRV Cruiser	550		2011 →	FDB2303	2	SG	FDB2303		SG
XT 550 i Prowler	550		2011 → 2012	FDB2303	2	SG	FDB2303		SG
650 V2 4 X 4 Auto LE Utility	650		2004 → 2005	FDB2303	2	SG	FDB2303		SG
650 V2 4 X 4 Auto Utility	650		2004 → 2006	FDB2303	2	SG	FDB2303		SG
650 V2 4 X 4 Auto LE TS Utility	650		2006 →	FDB2303	2	SG	FDB2303		SG
XT 650 H1 Prowler	650		2006 → 2009	FDB2303	2	SG	FDB2303		SG
650 H1 Prowler	650		2007 →	FDB2303	2	SG	FDB2303		SG
650 HI TBX 4x4 Auto Utility	650		2007 →	FDB2303	2	SG	FDB2303		SG
650 HI TRV 4X4 Auto Plus LE Multirider	650		2007 →	FDB2303	2	SG	FDB2303		SG
650 HI TRV 4X4 Auto Plus Multirider	650		2007 →	FDB2303	2	SG	FDB2303		SG
650 Prowler 4 X 4 / M4	650		2008 →	FDB2303	2	SG	FDB2303		SG
650 HI TRV 4X4 Auto	650		2008 →	FDB2303	2	SG	FDB2303		SG
650 H1 TRV	650		2009 →	FDB2303	2	SG	FDB2303		SG
650 TBX	650		2009 →	FDB2303	2	SG	FDB2303		SG
650 H1	650		2010 →	FDB2303	2	SG	FDB2303		SG
650 H1 Mudpro	650		2010 →	FDB2303	2	SG	FDB2303		SG
650 Mudpro	650		2010 → 2011	FDB2303	2	SG	FDB2303		SG
650 H1 4 X 4 Auto LE Utility	650		2007 →	FDB2175	2	SG	FDB2175		SG
700 EFI 4 X 4 LE Utility	700		2006 →	FDB2303	2	SG	FDB2303		SG
700 EFI 4 X 4 SE Utility	700		2006 →	FDB2303	2	SG	FDB2303		SG
700 Diesel Utility	700		2007 → 2008	FDB2303	2	SG	FDB2303		SG
700 EFI 4 X 4 Utility	700		2007 → 2008	FDB2303	2	SG	FDB2303		SG
700 EFI 4 x 4 Auto M4	700		2008 →	FDB2303	2	SG	FDB2303		SG
700 EFI 4 x 4 Auto TRV LE	700		2008 →	FDB2303	2	SG	FDB2303		SG
700 HI EFI 4x4 Auto SE	700		2008 → 2009	FDB2303	2	SG	FDB2303		SG
XTX 700 Hi LE Prowler	700		2008 →	FDB2303	2	SG	FDB2303		SG
700 H1 EFI	700		2009 → 2010	FDB2303	2	SG	FDB2303		SG
700 H1 EFI Mudpro	700		2009 → 2010	FDB2303	2	SG	FDB2303		SG
700 H1 EFI LE	700		2009 → 2010	FDB2303	2	SG	FDB2303		SG
700 TRV H2 EFI Cruiser	700		2009 → 2010	FDB2303	2	SG	FDB2303		SG
XTX 700 Hi EFI Prowler	700		2009 →	FDB2303	2	SG	FDB2303		SG
700 H1 TBX EFI	700		2010 →	FDB2303	2	SG	FDB2303		SG
700 Mudpro	700		2010 → 2011	FDB2303	2	SG	FDB2303		SG
700 S	700		2010 →	FDB2303	2	SG	FDB2303		SG
700 S LTD	700		2010 →	FDB2303	2	SG	FDB2303		SG
700 Super Duty Diesel	700		2010 → 2011	FDB2303	2	SG	FDB2303		SG
XTX 700	700		2010 → 2011	FDB2303	2	SG	FDB2303		SG
700 EFI Cruiser	700		2011 →	FDB2303	2	SG	FDB2303		SG
700 TBX LTD	700		2011 →	FDB2303	2	SG	FDB2303		SG
700 TRV	700		2011 → 2012	FDB2303	2	SG	FDB2303		SG
700 TRV Cruiser	700		2011 → 2012	FDB2303	2	SG	FDB2303		SG
700 TRV GT	700		2011 → 2012	FDB2303	2	SG	FDB2303		SG
700i	700		2011 → 2012	FDB2303	2	SG	FDB2303		SG
700i GT	700		2011 → 2012	FDB2303	2	SG	FDB2303		SG
700i LTD	700		2011 → 2012	FDB2303	2	SG	FDB2303		SG
700i Mudpro	700		2011 → 2012	FDB2303	2	SG	FDB2303		SG
700i Mudpro LTD	700		2011 →	FDB2303	2	SG	FDB2303		SG
HDX 700 i Prowler	700		2011 →	FDB2303	2	SG	FDB2303	2	SG
HDX 700 Prowler	700		2011 →	FDB2303	2	SG	FDB2303	2	SG
XTX 700 i Prowler	700		2011 → 2012	FDB2303	2	SG	FDB2303		SG
Thundercat 1000 H2	1000		2008 → 2010	FDB2303	2	SG	FDB2303		SG
1000 TRV H2 EFI Cruiser	1000		2009 → 2010	FDB2303	2	SG	FDB2303		SG
XTZ 1000 H2 Prowler	1000		2009 →	FDB2303	2	SG	FDB2303	2	SG
1000 H2 Mudpro EFI	1000		2010 →	FDB2303	2	SG	FDB2303		SG
1000 Mudpro	1000		2010 → 2011	FDB2303	2	SG	FDB2303		SG
1000 TRV H2 Efi	1000		2010 →	FDB2303	2	SG	FDB2303		SG
Thundercat 1000 H2 LE	1000		2010 →	FDB2303	2	SG	FDB2303		SG
XTZ 1000	1000		2010 → 2011	FDB2303	2	SG	FDB2303	2	SG
1000 GT	1000		2011 → 2012	FDB2303	2	SG	FDB2303		SG
1000 TRV Cruiser	1000		2011 →	FDB2303	2	SG	FDB2303		SG
XTZ 1000 i	1000		2011 → 2012	FDB2303	2	SG	FDB2303	2	SG
1000i Mudpro	1000		2012 →	FDB2303	2	SG	FDB2303		SG
WILDCAT 1000i H.O.	1000		2012 →	FDB2303	2	SG	FDB2303	2	SG
BOMBARDIER ATV									
DS 50 (2 STROKE)	50		2002 → 2006	FSB753	2		FSB958		
QUEST 50	50		2003 → 2004	FSB753	2		FSB958		
DS 90 (2 STROKE / 4 STROKE)	90		2002 → 2006	FSB753	2		FSB958		
QUEST 90 (2 STROKE / 4 STROKE)	90		2003 → 2004	FSB753	2		FSB958		
RALLY 200	200		2003 → 2007	FDB313	2	SG/P/EF			
DS 250	250		2006 → 2007	FDB2184	2	SG/P	FDB2184		SG/P
OUTLANDER 330 HO	330		2004 → 2005	FDB2148		left SG/EF			

ALL TERRAIN

* It is recommended that in those applications where sintered pads are supplied as Original Equipment, replacement pads should also be of sintered composition.

** To avoid brake imbalance sintered pads fitted in rear calipers should only be used in combination with front calipers containing sintered pads.



CC KW FROM -> TO N° SET L/R COMPOUND N° SET L/R COMPOUND

BOMBARDIER ATV

OUTLANDER 330 HO	330	2004 → 2005	FDB2149		right	SG			
OUTLANDER 330 HO	330	2004 → 2005					FDB2148		SG/EF
Outlander 400 (STD/MAX HO)	400	2003 → 2006	FDB2148		left	SG/EF			
Outlander 400 (STD/MAX HO)	400	2003 → 2006	FDB2149		right	SG			
Outlander 400 (STD/MAX HO)	400	2003 → 2006					FDB2148		SG/EF
QUEST 500 (2x4/4x4)	500	2002 → 2004	FDB2148		left	SG/EF			
QUEST 500 (2x4/4x4)	500	2002 → 2004	FDB2149		right	SG			
QUEST 500 (2x4/4x4)	500	2002 → 2004					FDB2149		SG
TRAXTER 500 (4x4/XL/Autoshift)	500	1999 → 2001	FDB2074			ST/SM/P/EF/CPRO/AG	FDB2074		ST/SM/P/EF/CPRO/AG
TRAXTER 500 (4x4/XL/Autoshift)	500	2001 → 2005	FDB2148		left	SG/EF			
TRAXTER 500 (4x4/XL/Autoshift)	500	2001 → 2005	FDB2149		right	SG			
TRAXTER 500 (4x4/XL/Autoshift)	500	2001 → 2005					FDB2149		SG
DS 650 (BAJA/X)	650	2000 → 2006	FDB2148		left	SG/EF			
DS 650 (BAJA/X)	650	2000 → 2006	FDB2149		right	SG			
DS 650 (BAJA/X)	650	2000 → 2006					FDB2148		SG/EF
Outlander 650 HO Efi (4x4/XT/Max)	650	2006 →	FDB2148		left	SG/EF			
Outlander 650 HO Efi (4x4/XT/Max)	650	2006 →	FDB2149		right	SG			
Outlander 650 HO Efi (4x4/XT/Max)	650	2006 →					FDB2148		SG/EF
Quest 650 (2x4/4x4/XT/Max)	650	2002 → 2005	FDB2148		left	SG/EF			
Quest 650 (2x4/4x4/XT/Max)	650	2002 → 2005	FDB2149		right	SG			
Quest 650 (2x4/4x4/XT/Max)	650	2002 → 2005					FDB2149		SG
Traxter 650 (XT-4x4/Footshift)	650	2000 →	FDB2074	2		ST/SM/P/EF/CPRO/AG	FDB2074		ST/SM/P/EF/CPRO/AG
TRAXTER 650 (Max/XT-4x4/Footshift)	650	2001 → 2005	FDB2148		left	SG/EF			
TRAXTER 650 (Max/XT-4x4/Footshift)	650	2001 → 2005	FDB2149		right	SG			
TRAXTER 650 (Max/XT-4x4/Footshift)	650	2001 → 2005					FDB2149		SG
Outlander 800	800	2006 →	FDB2148		left	SG/EF			
Outlander 800	800	2006 →	FDB2149		right	SG			
Outlander 800	800	2006 →					FDB2148		SG/EF
TRAXTER 1000 XL	1000	2004 →	FDB2148		left	SG/EF			
TRAXTER 1000 XL	1000	2004 →	FDB2149		right	SG			
TRAXTER 1000 XL	1000	2004 →					FDB2149		SG

CAN AM ATV

DS 70 (2x4/4T) Mini	70	2008 →	FSB753	2			FSB966		
DS 90 Mini 4 Stroke	90	2007 →	FSB753	2			FSB958		
DS 90 X (2x4/4T)	90	2008 → 2010	FDB313	2		SG/P/EF	FDB313		SG/P/EF
Rally 200	200	2007 →	FDB313	2		SG/P/EF	FDB2148		SG/EF
DS 250	250	2007 → 2009	FDB2184	2		SG/P	FDB2184		SG/P
Outlander 400 (STD/XT/EFI 4x4)	400	2007 → 2010	FDB2148		left	SG/EF			
Outlander 400 (STD/XT/EFI 4x4)	400	2007 → 2010	FDB2149		right	SG			
Outlander 400 (STD/XT/EFI 4x4)	400	2007 → 2010					FDB2148		SG/EF
Outlander Max 400 (STD/XT 4x4)	400	2007 → 2010	FDB2148		left	SG/EF			
Outlander Max 400 (STD/XT 4x4)	400	2007 → 2010	FDB2149		right	SG			
Outlander Max 400 (STD/XT 4x4)	400	2007 → 2010					FDB2148		SG/EF
DS 450 (2x4/EFI)	450	2008 → 2012	FDB2271			SG	FDB2272		SG
DS 450 X (2x4/EFI)	450	2008 → 2009	FDB2271			SG	FDB2272		SG
DS 450 Xxc/Xxm	450	2009 → 2012	FDB2271			SG	FDB2272		SG
Outlander 500 (STD/XT 4x4)	500	2007 → 2012	FDB2148		left	SG/EF			
Outlander 500 (STD/XT 4x4)	500	2007 → 2012	FDB2149		right	SG			
Outlander 500 (STD/XT 4x4)	500	2007 → 2012					FDB2148		SG/EF
Outlander Max 500 (STD/XT 4x4)	500	2007 → 2012	FDB2148		left	SG/EF			
Outlander Max 500 (STD/XT 4x4)	500	2007 → 2012	FDB2149		right	SG			
Outlander Max 500 (STD/XT 4x4)	500	2007 → 2012					FDB2148		SG/EF
Outlander 500 4 x 4 (STD/DPS/XT)	500	2013 →	FDB2274		left	SG			
Outlander 500 4 x 4 (STD/DPS/XT)	500	2013 →	FDB2273		right	SG			
Outlander 500 4 x 4 (STD/DPS/XT)	500	2013 →					FDB2273		SG
Outlander Max 500 4 x 4 (STD/DPS/XT)	500	2013 →	FDB2274		left	SG			
Outlander Max 500 4 x 4 (STD/DPS/XT)	500	2013 →	FDB2273		right	SG			
Outlander Max 500 4 x 4 (STD/DPS/XT)	500	2013 →					FDB2273		SG
Renegade 500 (4x4/EFI)	500	2008 → 2011	FDB2148		left	SG/EF			
Renegade 500 (4x4/EFI)	500	2008 → 2011	FDB2149		right	SG			
Renegade 500 (4x4/EFI)	500	2008 → 2011					FDB2148		SG/EF
Renegade 500 (STD)	500	2012 → 2013	FDB2274		left	SG			
Renegade 500 (STD)	500	2012 → 2013	FDB2273		right	SG			
Renegade 500 (STD)	500	2012 → 2013					FDB2273		SG
DS 650 X	650	2007 →	FDB2148		left	SG/EF			
DS 650 X	650	2007 →	FDB2149		right	SG			
DS 650 X	650	2007 →					FDB2148		SG/EF
Outlander 650 (STD/XT 4x4)	650	2007 → 2012	FDB2148		left	SG/EF			
Outlander 650 (STD/XT 4x4)	650	2007 → 2012	FDB2149		right	SG			
Outlander 650 (STD/XT 4x4)	650	2007 → 2012					FDB2148		SG/EF
Outlander Max 650 (STD/XT 4x4)	650	2007 → 2012	FDB2148		left	SG/EF			

* It is recommended that in those applications where sintered pads are supplied as Original Equipment, replacement pads should also be of sintered composition.

** To avoid brake imbalance sintered pads fitted in rear calipers should only be used in combination with front calipers containing sintered pads.

2002



CC KW FROM -> TO N° SET L/R COMPOUND N° SET L/R COMPOUND

...CAN AM ATV

Outlander Max 650 (STD/XT 4x4)	650	2007 → 2012	FDB2149		right	SG					
Outlander Max 650 (STD/XT 4x4)	650	2007 → 2012					FDB2148				SG/EF
Outlander 650 4 x 4 (STD/DPS/XT)	650	2013 →	FDB2274		left	SG					
Outlander 650 4 x 4 (STD/DPS/XT)	650	2013 →	FDB2273		right	SG					
Outlander 650 4 x 4 (STD/DPS/XT)	650	2013 →					FDB2273				SG
Defender 799	799	2016 →	FDB2315		left	SG	FDB2317		left		SG
Defender 799	799	2016 →	FDB2316		right	SG	FDB2318		right		SG
Defender DPS 799	799	2016 →	FDB2315		left	SG	FDB2317		left		SG
Defender DPS 799	799	2016 →	FDB2316		right	SG	FDB2318		right		SG
Defender XT 799	799	2016 →	FDB2315		left	SG	FDB2317		left		SG
Defender XT 799	799	2016 →	FDB2316		right	SG	FDB2318		right		SG
Defender XT Cab 799	799	2016 →	FDB2315		left	SG	FDB2317		left		SG
Defender XT Cab 799	799	2016 →	FDB2316		right	SG	FDB2318		right		SG
Outlander 800 (STD/XT 4x4)	800	2007 → 2011	FDB2148		left	SG/EF					
Outlander 800 (STD/XT 4x4)	800	2007 → 2011	FDB2149		right	SG					
Outlander 800 (STD/XT 4x4)	800	2007 → 2011					FDB2148				SG/EF
Outlander Max 800 (Ltd/STD/XT 4x4)	800	2007 → 2011	FDB2148		left	SG/EF					
Outlander Max 800 (Ltd/STD/XT 4x4)	800	2007 → 2011	FDB2149		right	SG					
Outlander Max 800 (Ltd/STD/XT 4x4)	800	2007 → 2011					FDB2148				SG/EF
Outlander 800 R (EFI/XT)	800	2009 → 2011	FDB2148		left	SG/EF					
Outlander 800 R (EFI/XT)	800	2009 → 2011	FDB2149		right	SG					
Outlander 800 R (EFI/XT)	800	2009 → 2011					FDB2148				SG/EF
Outlander Max 800 R (EFI/XT)	800	2009 → 2011	FDB2148		left	SG/EF					
Outlander Max 800 R (EFI/XT)	800	2009 → 2011	FDB2149		right	SG					
Outlander Max 800 R (EFI/XT)	800	2009 → 2011					FDB2148				SG/EF
Outlander 800 R STD	800	2012 →	FDB2274		left	SG					
Outlander 800 R STD	800	2012 →	FDB2273		right	SG					
Outlander 800 R STD	800	2012 →					FDB2273				SG
Outlander 800 R XT	800	2012 → 2013	FDB2274		left	SG					
Outlander 800 R XT	800	2012 → 2013	FDB2273		right	SG					
Outlander 800 R XT	800	2012 → 2013					FDB2273				SG
Outlander 800 R 4 x 4 (STD/DPS/XT/XT-P)	800	2013 →	FDB2274		left	SG					
Outlander 800 R 4 x 4 (STD/DPS/XT/XT-P)	800	2013 →	FDB2273		right	SG					
Outlander 800 R 4 x 4 (STD/DPS/XT/XT-P)	800	2013 →					FDB2273				SG
Renegade 800 (4x4/EFI) (STD/X)	800	2008 → 2011	FDB2148		left	SG/EF					
Renegade 800 (4x4/EFI) (STD/X)	800	2008 → 2011	FDB2149		right	SG					
Renegade 800 (4x4/EFI) (STD/X)	800	2008 → 2011					FDB2148				SG/EF
Renegade 800 R (EFI/X)	800	2009 → 2011	FDB2148		left	SG/EF					
Renegade 800 R (EFI/X)	800	2009 → 2011	FDB2149		right	SG					
Renegade 800 R (EFI/X)	800	2009 → 2011					FDB2148				SG/EF
Renegade 800 R STD	800	2012 → 2013	FDB2274		left	SG					
Renegade 800 R STD	800	2012 → 2013	FDB2273		right	SG					
Renegade 800 R STD	800	2012 → 2013					FDB2273				SG
Renegade 800 R Xcc	800	2012 → 2013	FDB2274		left	SG	FDB2274		left		SG
Renegade 800 R Xcc	800	2012 → 2013	FDB2273		right	SG	FDB2273		right		SG
Maverick X3	900	2017 →	FDB2315		left	SG	FDB2315		left		SG
Maverick X3	900	2017 →	FDB2316		right	SG	FDB2316		right		SG
Maverick X3 Max Turbo	900	2017 →	FDB2315		left	SG	FDB2315		left		SG
Maverick X3 Max Turbo	900	2017 →	FDB2316		right	SG	FDB2316		right		SG
Maverick X3 Max Turbo R	900	2018 →	FDB2315		left	SG	FDB2315		left		SG
Maverick X3 Max Turbo R	900	2018 →	FDB2316		right	SG	FDB2316		right		SG
Maverick X3 Turbo	900	2018 →	FDB2315		left	SG	FDB2315		left		SG
Maverick X3 Turbo	900	2018 →	FDB2316		right	SG	FDB2316		right		SG
Maverick X3 Turbo R	900	2018 →	FDB2315		left	SG	FDB2315		left		SG
Maverick X3 Turbo R	900	2018 →	FDB2316		right	SG	FDB2316		right		SG
Defender 976	976	2016 →	FDB2315		left	SG	FDB2317		left		SG
Defender 976	976	2016 →	FDB2316		right	SG	FDB2318		right		SG
Defender DPS 976	976	2016 →	FDB2315		left	SG	FDB2317		left		SG
Defender DPS 976	976	2016 →	FDB2316		right	SG	FDB2318		right		SG
Defender XT 976	976	2016 →	FDB2315		left	SG	FDB2317		left		SG
Defender XT 976	976	2016 →	FDB2316		right	SG	FDB2318		right		SG
Defender XT Cab 976	976	2016 →	FDB2315		left	SG	FDB2317		left		SG
Defender XT Cab 976	976	2016 →	FDB2316		right	SG	FDB2318		right		SG
Spyder RS (Brembo Calipers)	998	2013 →	FDB2265	2		ST/EF/CPRO					
Spyder RS-S (Brembo Calipers)	998	2013 →	FDB2265	2		ST/EF/CPRO					
Spyder ST (Brembo Calipers)	998	2013 →	FDB2265	2		ST/EF/CPRO					
Spyder ST - S (Brembo Calipers)	998	2013 →	FDB2265	2		ST/EF/CPRO					
Spyder ST -LTD (Brembo Calipers)	998	2013 →	FDB2265	2		ST/EF/CPRO					
Commander Max 1000 DPS/XT	1000	2014 →	FDB2301		left	SG	FDB2148		left		SG/EF
Commander Max 1000 DPS/XT	1000	2014 →	FDB2302		right	SG	FDB2149		right		SG
Maverick Max 1000 STD/XRS/DPS	1000	2014 → 2015	FDB2301		left	SG	FDB2148		left		SG/EF
Maverick Max 1000 STD/XRS/DPS	1000	2014 → 2015	FDB2302		right	SG	FDB2149		right		SG
Outlander 1000 STD	1000	2012 → 2013	FDB2274		left	SG	FDB2274		left		SG
Outlander 1000 STD	1000	2012 → 2013	FDB2273		right	SG	FDB2273		right		SG

* It is recommended that in those applications where sintered pads are supplied as Original Equipment, replacement pads should also be of sintered composition.

** To avoid brake imbalance sintered pads fitted in rear calipers should only be used in combination with front calipers containing sintered pads.



CC KW FROM -> TO N° SET L/R COMPOUND N° SET L/R COMPOUND

...CAN AM ATV

Outlander 1000 4 x 4 (DPS/XT/XT-P)	1000	2013	→	FDB2274		left	SG				
Outlander 1000 4 x 4 (DPS/XT/XT-P)	1000	2013	→	FDB2273		right	SG				
Outlander 1000 4 x 4 (DPS/XT/XT-P)	1000	2013	→					FDB2273			SG
Outlander 1000 4 x 4 (LTD)	1000	2013	→	FDB2274		left	SG				
Outlander 1000 4 x 4 (LTD)	1000	2013	→	FDB2273		right	SG				
Outlander 1000 4 x 4 (LTD)	1000	2013	→					FDB2273			SG
Outlander 1000 4 x 4 (XMR)	1000	2013	→	FDB2274		left	SG				
Outlander 1000 4 x 4 (XMR)	1000	2013	→	FDB2273		right	SG				
Outlander 1000 4 x 4 (XMR)	1000	2013	→					FDB2273			SG
Outlander 1000 XT	1000	2013	→	FDB2274		left	SG	FDB2274		left	SG
Outlander 1000 XT	1000	2013	→	FDB2273		right	SG	FDB2273		right	SG
Outlander Max 1000 4 x 4 (DPS/XT/XT-P)	1000	2013	→	FDB2274		left	SG				
Outlander Max 1000 4 x 4 (DPS/XT/XT-P)	1000	2013	→	FDB2273		right	SG				
Outlander Max 1000 4 x 4 (DPS/XT/XT-P)	1000	2013	→					FDB2273			SG
Renegade 1000 STD	1000	2013	→	FDB2274		left	SG	FDB2274		left	SG
Renegade 1000 STD	1000	2013	→	FDB2273		right	SG	FDB2273		right	SG
Renegade 1000 Xxc	1000	2013	→	FDB2274		left	SG	FDB2274		left	SG
Renegade 1000 Xxc	1000	2013	→	FDB2273		right	SG	FDB2273		right	SG
Spyder RT (Brembo Calipers)	1330	2013	→	FDB2265	2		ST/EF/CPRO				
Spyder RT - LTD (Brembo Calipers)	1330	2013	→	FDB2265	2		ST/EF/CPRO				
Spyder RT-S (Brembo Calipers)	1330	2013	→	FDB2265	2		ST/EF/CPRO				
Spyder RT (3 Cyl Eng/6 Speed)	1330	2014	→	FDB2265	2		ST/EF/CPRO				
Spyder RT - LTD (3 Cyl Eng/6 Speed)	1330	2014	→	FDB2265	2		ST/EF/CPRO				
Spyder RT-S (3 Cyl Eng/6 Speed)	1330	2014	→	FDB2265	2		ST/EF/CPRO				

CANNONDALE ATV

CANNIBAL 400 BLACK / SILVER	400	2002	→ 2003	FDB2148		left	SG/EF				
CANNIBAL 400 BLACK / SILVER	400	2002	→ 2003	FDB2149		right	SG				
CANNIBAL 400 BLACK / SILVER	400	2002	→ 2003					FDB2148			SG/EF
FX 400	400	2001	→	FDB2148		left	SG/EF				
FX 400	400	2001	→	FDB2149		right	SG				
FX 400	400	2001	→					FDB2148			SG/EF
BLAZE 440	440	2002	→ 2003	FDB2148		left	SG/EF				
BLAZE 440	440	2002	→ 2003	FDB2149		right	SG				
BLAZE 440	440	2002	→ 2003					FDB2148			SG/EF
GLAMIS 440	440	2003	→	FDB2148		left	SG/EF				
GLAMIS 440	440	2003	→	FDB2149		right	SG				
GLAMIS 440	440	2003	→					FDB2148			SG/EF
MOTO 440	440	2002	→ 2003	FDB2148		left	SG/EF				
MOTO 440	440	2002	→ 2003	FDB2149		right	SG				
MOTO 440	440	2002	→ 2003					FDB2148			SG/EF
SPEED 440	440	2002	→ 2003	FDB2148		left	SG/EF				
SPEED 440	440	2002	→ 2003	FDB2149		right	SG				
SPEED 440	440	2002	→ 2003					FDB2148			SG/EF

CFMOTO

CF 500-5 (Rancher 500 UTV)	500	2010	→ 2012	FDB497		left	ST/SM/SG/P/EF				
CF 500-5 (Rancher 500 UTV)	500	2010	→ 2012	FDB631		right	ST/SM/SG/P/EF/AG				
CF 500-5 (Rancher 500 UTV)	500	2010	→ 2012					FDB2193			SG
CF 500 (Terracross)	500	2011	→ 2012	FDB631		left	ST/SM/SG/P/EF/AG				
CF 500 (Terracross)	500	2011	→ 2012	FDB497		right	ST/SM/SG/P/EF				
CF 500 (Terracross)	500	2011	→ 2012					FDB2193			SG
CF 500 CFForce (5B/5C Classic Parking Brake)	500	2014	→ 2015	FDB2054			SG	FDB2193			SG
CF 500 UU-A UForce - side by side	550	2015	→ 2015	FDB497		left	ST/SM/SG/P/EF				
CF 500 UU-A UForce - side by side	550	2015	→ 2015	FDB631		right	ST/SM/SG/P/EF/AG				
CF 600 ZForce / ZForce EX - side by side	600	2013	→ 2015	FDB497		left	ST/SM/SG/P/EF				
CF 600 ZForce / ZForce EX - side by side	600	2013	→ 2015	FDB631		right	ST/SM/SG/P/EF/AG				
CF 625 - B/C (X6 Terranlander)	625	2011	→ 2012					FDB2193			SG
CF 625-3 (Z6 Terracross)	625	2011	→ 2012	FDB631		left	ST/SM/SG/P/EF/AG				
CF 625-3 (Z6 Terracross)	625	2011	→ 2012	FDB497		right	ST/SM/SG/P/EF				
CF 625-3 (Z6 Terracross)	625	2011	→ 2012					FDB2193			SG
CF 800-2 CFForce (Terranlander)	800	2012	→					FDB2193			SG
CF 800 UU-A UForce - side by side	800	2013	→ 2015	FDB497		left	ST/SM/SG/P/EF				
CF 800 UU-A UForce - side by side	800	2013	→ 2015	FDB631		right	ST/SM/SG/P/EF/AG				
CF 800 EX ZForce - side by side	800	2015	→	FDB497		left	ST/SM/SG/P/EF				
CF 800 EX ZForce - side by side	800	2015	→	FDB631		right	ST/SM/SG/P/EF/AG				

* It is recommended that in those applications where sintered pads are supplied as Original Equipment, replacement pads should also be of sintered composition.

** To avoid brake imbalance sintered pads fitted in rear calipers should only be used in combination with front calipers containing sintered pads.

2004

ALL TERRAIN



	CC	KW	FROM -> TO	N° SET	L/R	COMPOUND		N° SET	L/R	COMPOUND
CPI ATV										
250 XS	250		2006 →	FDB2184		SG/P	FDB631			ST/SM/SG/P/EF/AG
DERBI										
DFW 50	50		2004 → 2007	FSB714			FSB958			
DINLI ATV										
Diamond Back 90	90		2006 →				FDB313			SG/P/EF
E-TON ATV										
IXL 40 Rascal	40		1998 → 2001				FSB958			
JXL40	40		2001 → 2005				FSB958			
RXL-40E Viper Junior	40		2001 → 2006				FSB958			
Viper 40 E	40		1999 → 2008				FSB958			
AXL 50 Lightning 50	50		1999 → 2000	FSB756	2					
AXL50	50		1999 → 2000				FSB958			
BXL-50 Draco	50		2005 → 2006	FSB756	2		FDB313			SG/P/EF
NXL 50 Lightning 50	50		2001 → 2002	FSB756	2					
NXL50	50		2001 → 2002				FSB958			
RXL50	50		2002 →				FSB958			
TXL 50 Wizz 50	50		1998 → 1999	FSB756	2					
TXL50	50		1998 → 1999				FSB958			
Viper 50 Mini RXL 50 M (4T)	50		2003 → 2007				FDB313			SG/P/EF
Viper 50 RXL 50	50		2003 → 2007				FDB313			SG/P/EF
RXL70	70		2005 →				FSB958			
Viper 70 RLX 70/70M (2T/4T)	70		2005 → 2009	FSB756	2		FDB313			SG/P/EF
TXL80	80		1998 → 1999				FSB958			
AXL 90 Thunder	90		1999 → 2000	FSB756	2		FSB958			
DXL-90 Sierra	90		1999 → 2003	FSB727	2		FSB958			
NXL 90 Thunder	90		2001 → 2002	FSB756	2		FSB958			
RXL90	90		2002 →				FSB958			
RXL 90 R Viper 90 R Reverse (2T/4T)	90		2003 → 2009	FSB756	2		FDB313			SG/P/EF
RXL 90 Viper 90	90		2003 → 2006	FSB756	2		FDB313			SG/P/EF
BXL 100 Draco	100		2005 → 2006	FSB756	2		FDB313			SG/P/EF
CXL 150 Yukon II/Challenger	150		2002 → 2009	FSB704	2		FDB631			ST/SM/SG/P/EF/AG
CXL150	150		2002 →	FSB704			FSB958			
Yukon ELX 150	150		2005 → 2006	FDB313	2	SG/P/EF	FSB958			
RXL 150 Viper	150		2005 → 2006	FSB704	2		FDB631			ST/SM/SG/P/EF/AG
RXL 150 Viper R	150		2005 → 2009	FSB704	2		FDB631			ST/SM/SG/P/EF/AG
Viper EXL 150 ST Quad	150		2005 → 2006	FDB313	2	SG/P/EF	FSB958			
YXL 150 Yukon	150		2000 → 2002	FSB704	2		FSB958			
Vector VXL 250 ST Quad	250		2006 → 2009	FDB313	2	SG/P/EF	FDB313			SG/P/EF
GASGAS ATV										
WILD HP 50	50		2002 → 2005	FDB2018	2	ZR/ST/SG/P/EF	FDB2018			ZR/ST/SG/P/EF
HP 125	125		2007 → 2008	FDB2018	2	ZR/ST/SG/P/EF	FDB2018			ZR/ST/SG/P/EF
HP 200	200		2008 →	FDB2018	2	ZR/ST/SG/P/EF	FDB2018			ZR/ST/SG/P/EF
WILD HP 240	240		2002 → 2005	FDB2018	2	ZR/ST/SG/P/EF	FDB2018			ZR/ST/SG/P/EF
WILD HP 250	250		2008 →	FDB2018	2	ZR/ST/SG/P/EF	FDB2018			ZR/ST/SG/P/EF
HP 300 RV	300		2006 →	FDB2018	2	ZR/ST/SG/P/EF	FDB2018			ZR/ST/SG/P/EF
WILD HP 300	300		2002 → 2005	FDB2018	2	ZR/ST/SG/P/EF	FDB2018			ZR/ST/SG/P/EF
WILD HP 450	450		2002 → 2008	FDB2018	2	ZR/ST/SG/P/EF	FDB2018			ZR/ST/SG/P/EF
WILD HP 515	515		2009 →	FDB2018	2	ZR/ST/SG/P/EF	FDB2018			ZR/ST/SG/P/EF
HONDA 3 WHEELERS										
ATC 70	70		1976 → 1977				FSB704			
ATC 70	70		1978 → 1985				FSB706			
ATC 90	90		1973 → 1978				FSB760			
ATC 110	110		1979 → 1985				FSB760			
ATC 125	125		1984 → 1987	FSB704			FSB760			
ATC 185	185		1980 → 1983	FSB704			FSB760			
ATC 200 (Drum Brake)	200		1981 → 1986	FSB704			FSB760			
ATC 200 X (Disc Brake)	200		1983 → 1987	FDB381		SG/P/EF	FDB381			SG/P/EF
ATC 250 R	250		1981 → 1982	FDB250		SG/P/EF	FSB760			
ATC 250 R	250		1983 → 1984	FDB381		SG/P/EF	FDB381			SG/P/EF
ATC 250 R	250		1985 → 1986	FDB382		SG/P	FDB382			SG/P

* It is recommended that in those applications where sintered pads are supplied as Original Equipment, replacement pads should also be of sintered composition.

** To avoid brake imbalance sintered pads fitted in rear calipers should only be used in combination with front calipers containing sintered pads.



CC KW FROM -> TO

N° SET L/R COMPOUND

N° SET L/R COMPOUND

...HONDA 3 WHEELERS

ATC 250 SX / ES BIG RED	250	1985	→	1987	FSB760				FSB742			
ATC 350 X	350	1985	→	2000	FDB382			SG/P	FDB381			SG/P/EF
ATC 350 X	350	1986	→	2000	FDB495			SG/P	FDB381			SG/P/EF

HONDA ATV

TRX 70 Fourtrax	70	1986	→	1987	FSB753	2			FSB958			
TRX 90	90	1993	→	2009	FSB704	2			FSB760			
TRX 125 Fourtrax	125	1985	→	1988	FSB704	2			FSB760			
TRX 200 (4WD)	200	1990	→		FSB945				FSB760			
TRX 200 Fourtrax	200	1984	→	1985	FSB925	2			FSB760			
TRX 200 Fourtrax	200	1986	→	1998	FSB945	2			FSB760			
FL 250 ODYSSEY	250	1977	→	1984					FSB760			
TRX 250 Fourtrax	250	1985	→	1987	FSB925	2			FSB742			
TRX 250 R Fourtrax	250	1986	→	1989	FDB495	2		SG/P	FDB382			SG/P
TRX 250 X Fourtrax	250	1987	→	1992	FDB381	2		SG/P/EF	FDB381			SG/P/EF
TRX 250 TM2 Re Con	250	1997	→	2014	FSB945	2			FSB755			
TRX 250 EX	250	2001	→	2008	FDB381	2		SG/P/EF	FSB755			
TRX 250 TE2 Re Con ES	250	2002	→	2014	FSB945	2			FSB755			
TRX 250 X	250	2009	→	2011	FDB381	2		SG/P/EF	FSB755			
TRX 300 (2WD) Fourtrax	300	1988	→	2000	FSB945	2			FSB742			
TRX 300 (4WD) FW Fourtrax	300	1988	→	2000	FSB931	2			FSB742			
TRX 300 EX Fourtrax	300	1993	→	2008	FDB381	2		SG/P/EF	FDB381			SG/P/EF
TRX 300 X	300	2009	→		FDB381	2		SG/P/EF	FDB381			SG/P/EF
FL 350 R ODYSSEY	350	1985	→	1990	FSB925	2						
TRX 350/TRX 350D Fourtrax/Foreman	350	1986	→	1989					FSB761			
TRX 350 TM/TE/FE/FM Fourtrax Rancher	350	2000	→	2007	FSB931	2			FSB946			
FL 400 R Pilot	400	1989	→	1990	FSB925	2						
TRX 400 FW / FM Fourtrax Foreman	400	1995	→	2003	FDB381	2		SG/P/EF	FSB946			
TRX 400 EX Fourtrax/Sportrax	400	1999	→	2008	FDB381	2		SG/P/EF	FDB381			SG/P/EF
TRX 400 Fourtrax Rancher	400	2004	→	2007	FSB931	2			FSB946			
TRX 400 X	400	2009	→		FDB381	2		SG/P/EF	FDB381			SG/P/EF
TRX 420 TM/TE/FE/FM Fourtrax Rancher	420	2007	→	2010	FDB381	2		SG/P/EF	FSB946			
TRX 420 FA/FPA P.S.Fourtrax Rancher	420	2009	→	2010	FDB381	2		SG/P/EF	FDB2182			SG
TRX 420 FPE/FPM Fourtrax Rancher 4x4	420	2009	→	2010	FDB381	2		SG/P/EF	FSB946			
TRX 450 FE/FM Fourtrax Foreman ES / S	450	1998	→	2004	FSB931	2			FSB946			
TRX 450 R/ER	450	2004	→	2009	FDB892	2		ZR/SG/P/EF/CPRO	FDB2182			SG
TRX 500 FA Fourtrax Rubicon	500	2001	→	2004	FSB931	2			FSB761			
TRX 500 FGA Fourtrax Foreman Rubicon Gpscape	500	2001	→	2005	FSB931	2			FSB761			
TRX 500 FA/FAA Fourtrax Foreman Rubicon	500	2005	→	2010	FDB2195	2		SG	FSB761			
TRX 500 FGA Fourtrax Foreman Rubicon Gpscape	500	2005	→	2009	FDB2195	2		SG	FSB761			
TRX 500 TM/FE/FA/FMA/FPE/FPM Fourtrax Foreman	500	2005	→	2010	FDB2195	2		SG	FSB761			
TRX 500 FPA9 Fourtrax Foreman Rub.Gpscape EPS	500	2009	→		FDB2195	2		SG	FSB761			
TRX 650 FA Rincon / FGA Fourtrax Rincon Gpscape	650	2003	→	2005	FSB931	2			FDB2182			SG
TRX 680 Fourtrax Rincon	680	2006	→	2010	FDB2195	2		SG	FDB2182			SG
TRX 680 Fourtrax Rincon Gpscape	680	2006	→	2009	FDB2195	2		SG	FDB2182			SG
TRX 700 XX (8/XX9)	700	2008	→	2009	FDB892	2		ZR/SG/P/EF/CPRO	FDB2195			SG

HYOSUNG ATV

RAPIER 450 /S	450	2008	→		FDB2016	2		SG	FDB2016			SG
TE 450 S	450	2007	→	2010	FDB250	2		SG/P/EF	FDB250			SG/P/EF

JOHN DEERE ATV

4PX Gator 4x2/4x4 4x4 Trail 9345		2004	→	2005	FDB2272			SG	FDB2272			SG
HPX Gator 4x2/4x4 9446		2004	→	2008	FDB2272			SG	FDB2272			SG
HPX 4 x2 (Petrol) Gator		2010	→	2011	FDB2272			SG	FDB2272			SG
HPX 4 x4 / 4 x 4 Trail (Petrol) - Gator		2010	→	2011	FDB2272			SG	FDB2272			SG
HPX 4x4 (Diesel) - Gator - (SN040000)		2010	→		FDB2272			SG	FDB2272			SG
TX Gator Utility 9461		2004	→	2005	FDB2272			SG	FDB2272			SG
TX Turf Gator 9462		2004	→	2005	FDB2272			SG	FDB2272			SG
Buck 500 EX	500	2004	→	2008	FDB2148		left	SG/EF				
Buck 500 EX	500	2004	→	2008	FDB2149		right	SG				
Buck 500 EX	500	2004	→	2008					FDB2149			SG
Trail Buck 500 EX	500	2004	→	2005	FDB2148		left	SG/EF				
Trail Buck 500 EX	500	2004	→	2005	FDB2149		right	SG				
Trail Buck 500 EX	500	2004	→	2005					FDB2149			SG
Buck 650 EXT	650	2004	→	2008	FDB2148		left	SG/EF				
Buck 650 EXT	650	2004	→	2008	FDB2149		right	SG				
Buck 650 EXT	650	2004	→	2008					FDB2149			SG
Trail Buck 650 EXT	650	2004	→	2005	FDB2148		left	SG/EF				

* It is recommended that in those applications where sintered pads are supplied as Original Equipment, replacement pads should also be of sintered composition.

** To avoid brake imbalance sintered pads fitted in rear calipers should only be used in combination with front calipers containing sintered pads.

2006

FERODO

RACING

Updated on November 2020



	CC	KW	FROM -> TO	N° SET	L/R	COMPOUND	N° SET	L/R	COMPOUND
...JOHN DEERE ATV									
Trail Buck 650 EXT	650		2004 → 2005	FDB2149					
Trail Buck 650 EXT	650		2004 → 2005		right	SG	FDB2149		SG
KAWASAKI 3 WHEELERS									
KLT 110 A1 / A2 / A3	110		1984 → 1986	FSB722			FSB721		
KLT 160 A1	160		1985 → 2000	FSB722			FSB721		
KLT 185 A1 / A2	185		1986 → 1987	FSB722			FSB721		
KLT 200 All Models	200		1981 → 1984	FSB722			FSB799		
KLT 250 All Models	250		1982 → 2000	FSB722			FSB799		
KXT 250 TECATE	250		1984 → 2000	FSB799			FDB313		SG/P/EF
KXT 250 A2 / B1 TECATE	250		1985 → 1986	FDB314		ST/SG/P/EF	FDB314		ST/SG/P/EF
KXT 250 B2 TECATE	250		1987 → 2000	FDB314	2	ST/SG/P/EF	FDB381		SG/P/EF
KAWASAKI ATV									
KFX 50 / KSF 50	50		2007 → 2009	FSB756	2		FDB2096		SG/EF
KSF 50 / KFX 50	50		2003 → 2007	FSB727	2		FSB723		
KSF 80 / KFX 80	80		2003 → 2006	FSB727	2		FSB776		
KFX 90 / KSF 90	90		2007 → 2010	FSB756	2		FDB2096		SG/EF
KSF 90 / KFX 90	90		2006 → 2007	FSB727	2		FSB776		
KLF 110 MOJAVE A / B	110		1987 → 1988	FSB722	2		FSB721		
KLF 185 BAYOU A1 Series	185		1985 → 2000				FSB718		
KLF 185 BAYOU A2 / A3 / A4	185		1986 → 1988	FSB799	2		FSB718		
KLF 220 BAYOU A Series	220		1988 → 2002	FSB799	2		FSB718		
KLF 250 BAYOU A Series	250		2003 → 2010	FSB799	2		FSB718		
KSF 250 MOJAVE A Series	250		1987 → 2005	FDB2013	2	SG	FDB381		SG/P/EF
KSF 250 A8 - A9	250		1994 → 1995	FDB2013	2	SG	FDB661		SG/P
KXF 250 Tecate	250		1987 → 1988	FDB2013		SG	FDB381		SG/P/EF
KXF 250 Tecate	250		1989 →	FDB2013	2	SG	FDB313		SG/P/EF
KEF 300 LAKOTA A Series, LAKOTA SPORT B Series	300		1995 → 2003	FDB2013	2	SG	FDB381		SG/P/EF
KLF 300 BAYOU A Series	300		1986 → 1987	FSB932	2		FSB718	2	
KLF 300 BAYOU B Series	300		1988 → 2004	FDB314	2	ST/SG/P/EF	FSB718	2	
KLF 300 BAYOU 4x4 C Series (left)	300		1989 → 2004	FDB497		ST/SM/SG/P/EF	FSB794		
KLF 300 BAYOU 4x4 C Series (right)	300		1989 → 2004	FDB631		ST/SM/SG/P/EF/AG			
KVF 300 PRAIRIE (2x4/4x4)	300		1999 → 2002	FDB250	2	SG/P/EF	FSB794		
KVF 360 PRAIRIE (All Models)	360		2003 → 2010	FDB250	2	SG/P/EF			
KLF 400 BAYOU 4x4 B Series (left)	400		1993 → 1999	FDB497		ST/SM/SG/P/EF	FSB794		
KLF 400 BAYOU 4x4 B Series (right)	400		1993 → 1999	FDB631		ST/SM/SG/P/EF/AG			
KSF 400 / KFX 400	400		2004 → 2006	FDB381	2	SG/P/EF	FDB2016		SG
KVF 400 PRAIRIE (2x4/4x4)	400		1997 → 2002	FDB381	2	SG/P/EF	FSB794		
KFX 450 R	450		2008 → 2012	FDB2188		left	SG		
KFX 450 R	450		2008 → 2012	FDB2080		right	SG		
KFX 450 R	450		2008 → 2012				FDB381		SG/P/EF
KSF 450 / KFX 450	450		2007 →	FDB381	2	SG/P/EF	FDB2016		SG
KVF 650 PRAIRIE	650		2002 → 2003	FDB2188		left	SG		
KVF 650 PRAIRIE	650		2002 → 2003	FDB2080		right	SG		
KVF 650 BRUTE FORCE	650		2005 → 2007	FDB2188		left	SG		
KVF 650 BRUTE FORCE	650		2005 → 2007	FDB2080		right	SG		
KVF 650 Brute Force 4X4i All models	650		2007 → 2008	FDB497		left	ST/SM/SG/P/EF		
KVF 650 Brute Force 4X4i All models	650		2007 → 2008	FDB631		right	ST/SM/SG/P/EF/AG		
KFX 700	700		2004 → 2009	FDB2188		left	SG		
KFX 700	700		2004 → 2009	FDB2080		right	SG		
KRF 750 Teryx 4x4 All mod.-side by side	750		2008 →	FDB497		left	ST/SM/SG/P/EF		
KRF 750 Teryx 4x4 All mod.-side by side	750		2008 →	FDB631		right	ST/SM/SG/P/EF/AG		
KVF 750 BRUTE FORCE All Models	750		2005 → 2010	FDB497		left	ST/SM/SG/P/EF		
KVF 750 BRUTE FORCE All Models	750		2005 → 2010	FDB631		right	ST/SM/SG/P/EF/AG		
KEEWAY									
Dragon 250 Quad	250		2007 → 2009	FDB313	2	SG/P/EF	FDB250		SG/P/EF
KYMCO ATV									
MAXXER 50	50		2005 →	FSB753	2		FSB966		
Mongoose 50 (2T)	50		2004 → 2008	FSB753	2		FSB966		
Mongoose 50 (4T) (Rear disc model)	50		2008 → 2009	FSB753	2		FDB2096		SG/EF
MXer 50	50		2000 → 2007	FSB704	2		FDB2096		SG/EF
MXU 50	50		2005 → 2013	FSB704	2		FDB2096		SG/EF
Mongoose 70 (4T)	70		2007 → 2009	FSB753	2		FDB2096		SG/EF
KXR 90 MONGOOSE	90		2002 → 2010	FSB753	2		FDB2096		SG/EF

ALL TERRAIN

* It is recommended that in those applications where sintered pads are supplied as Original Equipment, replacement pads should also be of sintered composition.

** To avoid brake imbalance sintered pads fitted in rear calipers should only be used in combination with front calipers containing sintered pads.



CC KW FROM -> TO N° SET L/R COMPOUND N° SET L/R COMPOUND

...KYMCO ATV

MAXXER 90	90	2005 → 2006	FSB753	2			FDB2096		SG/EF
MXer 90	90	2004 →	FSB756	2			FDB2096		SG/EF
MXU 150	150	2005 → 2012	FSB704	2			FDB2096		SG/EF
KXR 250 MONGOOSE	250	2004 → 2009	FDB2184	2		SG/P	FDB2141		SG/EF
MXU 250	250	2004 → 2013	FDB2184	2		SG/P	FDB2141	2	SG/EF
MXU 250 R	250	2012 → 2013	FDB2184	2		SG/P	FDB2184		SG/P
URBAN 250	250	2006 → 2007	FDB2184	2		SG/P	FDB2141		SG/EF
MAXXER 300	300	2006 → 2013	FDB2184	2		SG/P	FDB2141		SG/EF
Mongoose 300	300	2006 → 2010	FDB2184	2		SG/P	FDB2141	2	SG/EF
MXU 300	300	2006 → 2011	FDB2184	2		SG/P	FDB2184	2	SG/P
MXU 300 R	300	2010 →	FDB2184	2		SG/P	FDB2184	2	SG/P
Maxxer 400	400	2009 → 2010	FDB2303	2		SG	FDB2303		SG
MXU 400	400	2008 → 2011	FDB2184	2		SG/P	FDB2184	2	SG/P
MXU 400 (A40000)	400	2008 → 2011	FDB2303	2		SG	FDB2303		SG
MXU 400 Parking brake	400	2008 → 2011	FDB381			SG/P/EF			
Maxxer 450 i	450	2010 → 2012	FDB2303	2		SG	FDB2303		SG
MXU 450 i IRS	450	2011 → 2012	FDB2303	2		SG	FDB2303		SG
MXU 500 (L70000/Carb Model/4x4)	500	2005 → 2013	FDB2184	2		SG/P	FDB2184	2	SG/P
MXU 500i DX Parking Brake	500	2012 → 2013	FDB2184			SG/P			
MXU 500i IRS Parking Brake	500	2012 → 2013	FDB2184			SG/P			
UXV 500 (Side x Side/4x4/U10000)	500	2008 → 2009	FDB2184	2		SG/P	FDB2184		SG/P
UXV 500i (Side x Side/4x4/U10100)	500	2010 →	FDB2184	2		SG/P	FDB2184		SG/P
MXU 550i Parking Brake	550	2012 → 2012	FDB2184			SG/P			
MXU 550i (4x4 LoF) Parking Brake	550	2013 →	FDB2184			SG/P			
MXU 700i (4X4 LoF) Parking Brake	700	2013 →	FDB2184			SG/P			
UXV 700i (Turf) Parking Brake	700	2014 →	FDB2184			SG/P			

LAVERDA ATV

QUASAR 400 4x4	400	2004 →	FDB2175	2		SG	FDB2175		SG
QUASAR 500 4x4	500	2004 →	FDB2175	2		SG			

MASSEY-FERGUSON

MF 400/4WD Auto (376cc)	400	2005 → 2009	FDB2303	2		SG	FDB2303		SG
MF 500/4WD Auto (493cc)	500	2005 → 2009	FDB2303	2		SG	FDB2303		SG
MF 650 2 cyl/4WD Auto (633cc)	650	2005 → 2009	FDB2303	2		SG	FDB2303		SG
MF 650/4WD Auto (641cc)	650	2005 → 2009	FDB2303	2		SG	FDB2303		SG
MF 700 2 D/4WD Auto (686cc Diesel)	700	2005 → 2008	FDB2303	2		SG	FDB2303		SG

PGO ATV

Bugrider 50 (Buggie)	50	2006 → 2006					FDB250		SG/P/EF
X Rider 50	50	2004 → 2005					FDB313		SG/P/EF
XL-Rider 50	50	2007 → 2008					FDB313		SG/P/EF
X Rider 90	90	2004 → 2005					FDB313		SG/P/EF
X Rider 110	110	2004 → 2005					FDB313		SG/P/EF
Bugxter BR150 A	150	2005 → 2007					FDB250		SG/P/EF
X Rider 150	150	2004 → 2005	FSB756	2			FDB313		SG/P/EF
BR 500i Racer	500	2007 → 2009					FDB2184	2	SG/P
500 Bug	500	2008 → 2009					FDB2184		SG/P
500 Bug Parking brake	500	2008 → 2009	FDB2054			SG			
BR 600i Racer	600	2012 → 2012					FDB2184	2	SG/P

PIAGGIO

Trackmaster 400 Quad	400	2006 →	FDB2303	2		SG	FDB2303		SG
----------------------	-----	--------	---------	---	--	----	---------	--	----

POLARIS ATV

BIG BOSS (All middle axle brake models)		1989 → 1999	FDB2055	2		SG			
BIG BOSS (All standard models)		1989 → 1999	FDB2055	2		SG	FDB2054		SG
MAGNUM (All models)		1999 → 2001	FDB2055	2		SG	FDB2121		SG
MAGNUM (All models)		2002 → 2006	FDB2055	2		SG	FDB2176		SG
Ranger 2x4/4x4 - side by side		2004 → 2005	FDB2236			SG	FDB2236	2	SG
Ranger 6x6 - side by side		2004 → 2005	FDB2236	2		SG	FDB2236	2	SG
Ranger TM - side by side		2004 →	FDB2236	2		SG	FDB2236	2	SG
Ranger XP - side by side		2005 →	FDB2236			SG	FDB2236		SG
Ranger EV (Electric) - side by side		2010 → 2011	FDB2263	2		SG	FDB2236	2	SG
SCRAMBLER (3 wheeler)		1985 → 1986	FSB731						

* It is recommended that in those applications where sintered pads are supplied as Original Equipment, replacement pads should also be of sintered composition.

** To avoid brake imbalance sintered pads fitted in rear calipers should only be used in combination with front calipers containing sintered pads.

2008

FERODO
RACING
Updated on November 2020

ALL TERRAIN



CC KW FROM -> TO N° SET L/R COMPOUND N° SET L/R COMPOUND

...POLARIS ATV

SCRAMBLER (All Models)		1995 → 1997	FDB2055	2		SG	FDB2054		SG
SCRAMBLER (All Models)		1998 → 2004	FDB2055	2		SG	FDB2121		SG
SPORTSMAN (All Models)		1993 → 1997	FDB2055	2		SG	FDB2054		SG
TRAIL BOSS 2x4		1985 → 1987	FSB731	2					
TRAIL BOSS (All Models)		1988 → 1999	FDB2055	2		SG	FDB2054		SG
TRAIL BOSS (All Models)		2000 → 2004	FDB2055	2		SG	FDB2121		SG
Outlaw 50	50	2007 → 2010	FSB756	2			FSB966		
PREDATOR 50	50	2004 → 2006	FSB753	2			FSB966		
Predator 50 (2 stroke)	50	2004 → 2006	FSB756	2			FSB966		
SCRAMBLER 50	50	2001 → 2006	FSB753	2			FSB966		
Outlaw 90	90	2007 → 2010	FSB756	2			FSB966		
PREDATOR 90	90	2003 → 2006	FSB753	2			FSB966		
SCRAMBLER 90	90	2001 → 2003	FSB753	2			FSB966		
SPORTSMAN 90	90	2001 → 2010	FSB753	2			FSB966		
Phoenix 200 (Rear disc model)	200	2005 → 2008	FDB313	2		SG/P/EF	FDB313		SG/P/EF
PHOENIX 200 (Rear drum model)	200	2005 → 2010	FDB313	2		SG/P/EF	FSB760		
Sawtooth 200 (Rear disc model)	200	2006 →	FDB313	2		SG/P/EF	FDB313		SG/P/EF
SAWTOOTH 200 (Rear drum model)	200	2006 →	FDB313	2		SG/P/EF	FSB760		
250 2x4/4x4	250	1990 → 1995	FDB2055	2		SG	FDB2054		SG
CYCLONE 250 X	250	1987 → 2000	FSB731	2					
TRAIL BLAZER 250	250	1990 → 1998	FDB2055	2		SG	FDB2054		SG
TRAIL BLAZER 250	250	1999 → 2004	FDB2055	2		SG	FDB2121		SG
TRAIL BLAZER 250	250	2005 → 2006	FDB2055	2		SG	FDB2176		SG
XPLORER 250	250	2000 →	FDB2055	2		SG	FDB2121		SG
300 2x4/4x4	300	1990 → 1995	FDB2055	2		SG	FDB2054		SG
300 Hawkeye 2x4	300	2006 →	FDB2303	2		SG	FDB2303	2	SG
300 Hawkeye 4x4	300	2006 →	FDB2303	2		SG	FDB2303	2	SG
HAWKEYE 300 2x4	300	2006 →	FDB2055	2		SG	FDB2055		SG
HAWKEYE 300 4x4	300	2007 →	FDB2055	2		SG	FDB2055	2	SG
Sportsman 300 4x4	300	2008 → 2010	FDB2055	2		SG	FDB2055		SG
XPLORER 300	300	1996 → 2000	FDB2055	2		SG	FDB2054		SG
Xpress L (All models)	300	1996 → 2000	FDB2055	2		SG	FDB2054		SG
Ranger 325 ETX - side by side	325	2015 → 2015	FDB2236	2		SG	FDB2236	2	SG
Sportsman ACE 325	325	2014 → 2014	FDB2263	2		SG	FDB2236	2	SG
XPEDITION 325	325	2000 → 2001	FDB2055	2		SG	FDB2121		SG
XPEDITION 325	325	2002 →	FDB2055	2		SG	FDB2176		SG
ATP 330	330	2004 → 2005	FDB2055	2		SG	FDB2055		SG
Trail Blazer 330	330	2008 → 2010	FDB2055	2		SG	FDB2176		SG
TRAIL BOSS 330	330	2005 → 2010	FDB2055	2		SG	FDB2176		SG
SPORTSMAN 335	335	1999 → 2000	FDB2055	2		SG	FDB2121		SG
L 350 2x4/4x4	350	1990 → 1995	FDB2055	2		SG	FDB2054		SG
Sportsman 350 4x4	350	1993 →	FDB2055	2		SG	FDB2054		SG
TRAIL BOSS 350 (All Models)	350	1991 → 1993	FDB2055	2		SG	FDB2054		SG
L 400 2x4/4x4	400	1990 → 1995	FDB2055	2		SG	FDB2054		SG
Ranger 400 - side by side	400	2010 →	FDB2263	2		SG	FDB2236	2	SG
Sport 400	400	1994 → 1998	FDB2055	2		SG	FDB2054		SG
Sport 400	400	1999 → 2000	FDB2055	2		SG	FDB2121		SG
SPORTSMAN 400	400	2001 → 2002	FDB2055	2		SG	FDB2121		SG
SPORTSMAN 400	400	2003 → 2005	FDB2055	2		SG	FDB2176		SG
Sportsman 400 HO 4x4	400	2008 → 2010	FDB2055	2		SG	FDB2055	2	SG
XPLORER 400	400	1995 → 1998	FDB2055	2		SG	FDB2054		SG
XPLORER 400	400	1999 → 2002	FDB2055	2		SG	FDB2121		SG
MAGNUM 425 (All Models)	425	1995 → 1998	FDB2055	2		SG	FDB2054		SG
XPEDITION 425	425	2000 →	FDB2055	2		SG	FDB2121		SG
Outlaw S 450	450	2008 →	FDB2320	2		SG	FDB2055	2	SG
Outlaw MXR 450	450	2009 → 2011	FDB2320	2		SG	FDB2055	2	SG
Sportsman 450	450	2006 →	FDB2055	2		SG	FDB2176		SG
DIESEL 455	455	1999 → 2001	FDB2055	2		SG	FDB2121		SG
ATP 500 H0	500	2004 → 2005	FDB2055	2		SG	FDB2055	2	SG
Outlaw 500	500	2006 → 2007	FDB2055	2		SG	FDB2055		SG
PREDATOR 500	500	2003 → 2007	FDB2055	2		SG	FDB2055		SG
Ranger 500 (2x4/4x4) - side by side	500	2006 → 2007	FDB2236	2		SG	FDB2236	2	SG
Ranger 500 4x4 EFI - side by side	500	2006 → 2007	FDB2236	2		SG	FDB2236	2	SG
Ranger 500 2x4 - side by side	500	2008 →	FDB2263	2		SG	FDB2236	2	SG
Ranger 500 4x4 EFI - side by side	500	2008 →	FDB2263	2		SG	FDB2236	2	SG
Ranger 500 (Carb) 2x4 -side by side	500	2009 →	FDB2263	2		SG	FDB2236	2	SG
Ranger 500 (EFI) 4x4 H.O. - side by side	500	2009 → 2011	FDB2263	2		SG	FDB2236	2	SG
Ranger 500 Crew - side by side	500	2011 →	FDB2263	2		SG	FDB2236	2	SG
SCRAMBLER 500 (All models)	500	2005 → 2010	FDB2055	2		SG	FDB2176		SG
SPORTSMAN 500	500	1998 → 2002	FDB2055	2		SG	FDB2121		SG
SPORTSMAN 500 6x6	500	2000 → 2008	FDB2055	2		SG			
SPORTSMAN 500 HO/EFI/X2/EFI Quad H.O.	500	2003 → 2010	FDB2055	2		SG	FDB2176		SG
Sportsman 500 X2 EFI	500	2007 → 2009	FDB2055	2		SG	FDB2055		SG
Sportsman 500 Touring H.O.	500	2008 → 2010	FDB2055	2		SG	FDB2055	2	SG

* It is recommended that in those applications where sintered pads are supplied as Original Equipment, replacement pads should also be of sintered composition.

** To avoid brake imbalance sintered pads fitted in rear calipers should only be used in combination with front calipers containing sintered pads.



CC KW FROM -> TO N° SET L/R COMPOUND N° SET L/R COMPOUND

...POLARIS ATV

XP Sportsman 500	500	2009	→	FDB2276	2		SG	FDB2276			SG
XPLORER 500	500	1997	→ 2000	FDB2055	2		SG	FDB2054			SG
Outlaw IRS 525	525	2008	→ 2013	FDB2320	2		SG	FDB2055	2		SG
Outlaw S 525	525	2008	→ 2011	FDB2320	2		SG	FDB2055	2		SG
Sportsman EPS 550	550	2010	→ 2012	FDB2276	2		SG	FDB2276			SG
Sportsman Forest 550	550	2010	→ 2012	FDB2276	2		SG	FDB2276			SG
Sportsman Touring EPS 550	550	2010	→ 2012	FDB2276	2		SG	FDB2276			SG
Sportsman X2 550	550	2010	→	FDB2276	2		SG	FDB2276			SG
Sportsman X2 550	550	2010	→ 2011	FDB2276	2		SG	FDB2276			SG
Sportsman 550	550	2011	→ 2012	FDB2276	2		SG	FDB2276			SG
XP Sportsman EPS 500	550	2009	→ 2011	FDB2276	2		SG	FDB2276			SG
Ranger 570 Crew Efi - side by side	570	2014	→ 2015	FDB2263	2		SG	FDB2236	2		SG
Ranger 570 Efi - side by side	570	2014	→ 2012	FDB2236	2		SG	FDB2236	2		SG
RZR 570	570	2012	→ 2014	FDB2320	2		SG	FDB2055	2		SG
Sportsman ACE 570	570	2015	→ 2015	FDB2263	2		SG	FDB2236	2		SG
SPORTSMAN 600	600	2003	→ 2006	FDB2055	2		SG	FDB2176			SG
Ranger 700 6x6 Efi - side by side	700	2006	→ 2009	FDB2236	2		SG	FDB2236	2		SG
Ranger 700 XP 4x4 - side by side	700	2006	→ 2008	FDB2236	2		SG	FDB2236	2		SG
Ranger 700 4x4 Efi/LE - side by side	700	2007	→	FDB2236	2		SG	FDB2236	2		SG
Ranger 700 6x4 Efi - side by side	700	2008	→	FDB2263	2		SG	FDB2236	2		SG
Ranger 700 XP 4x4 - side by side	700	2008	→	FDB2263	2		SG	FDB2236	2		SG
Ranger 700 4x4 Efi - side by side	700	2009	→	FDB2263	2		SG	FDB2236	2		SG
Ranger 700 Crew (Efi) 4x4 - side by side	700	2009	→	FDB2263	2		SG	FDB2263	2		SG
SPORTSMAN 700	700	2003	→ 2007	FDB2055	2		SG	FDB2176	2		SG
Sportsman 700 X2	700	2008	→	FDB2055	2		SG	FDB2055			SG
Ranger 800 - side by side	800	2010	→ 2012	FDB2263	2		SG	FDB2236	2		SG
Ranger 800 6x6 - side by side	800	2010	→	FDB2263	2		SG	FDB2236	2		SG
Ranger 800 Crew - side by side	800	2010	→	FDB2263	2		SG	FDB2236	2		SG
Ranger 800 HD - side by side	800	2010	→	FDB2263	2		SG	FDB2236	2		SG
Ranger 800 RZR-4 Efi - side by side	800	2010	→	FDB2263	2		SG	FDB2236	2		SG
Ranger 800 XP - side by side	800	2010	→ 2012	FDB2263	2		SG	FDB2236	2		SG
Ranger 800 RZR-4 EPS - side by side	800	2012	→ 2012	FDB2263	2		SG	FDB2236	2		SG
Ranger 800 Mid Size - side by side	800	2013	→ 2014	FDB2236	2		SG	FDB2236	2		SG
Ranger 800 RZR Efi - side by side	800	2013	→ 2014	FDB2263	2		SG	FDB2236	2		SG
RZR 800 (EPS Models)	800	2008	→ 2014	FDB2320	2		SG	FDB2055	2		SG
RZR-4 800 - side by side	800	2012	→ 2012	FDB2263	2		SG	FDB2236	2		SG
SPORTSMAN 800 Efi/HO	800	2005	→ 2010	FDB2055	2		SG	FDB2176	2		SG
Sportsman 800 X2 Efi	800	2007	→ 2009	FDB2055	2		SG	FDB2055	2		SG
Sportsman 800 Touring/Efi	800	2008	→ 2009	FDB2055	2		SG	FDB2055	2		SG
Sportsman 800 Efi 6x6 Big Boss	800	2009	→ 2010	FDB2055	2		SG	FDB2055	2		SG
Sportsman Forest 800	800	2012	→	FDB2276	2		SG	FDB2276			SG
Scrambler 850	850	2015	→ 2015	FDB2276	2		SG	FDB2276	2		SG
Sportsman Touring EPS 850	850	2010	→ 2012	FDB2276	2		SG	FDB2276			SG
Sportsman Forest 850	850	2012	→	FDB2276	2		SG	FDB2276	2		SG
Sportsman 850 XP H.O. EPS	850	2013	→ 2015	FDB2276	2		SG	FDB2276			SG
XP EPS Sportsman 850	850	2009	→ 2013	FDB2276	2		SG	FDB2276			SG
XP Sportsman 850	850	2009	→ 2012	FDB2276	2		SG	FDB2276			SG
Ranger 900 Crew - side by side	900	2010	→ 2015	FDB2263	2		SG	FDB2263	2		SG
Ranger 900 D 4x4 Diesel - side by side	900	2011	→	FDB2263	2		SG	FDB2236	2		SG
Ranger 900 RZR XP - side by side	900	2011	→ 2012	FDB2263	2		SG	FDB2236	2		SG
Ranger 900 D Crew - side by side	900	2013	→ 2014	FDB2263	2		SG	FDB2263	2		SG
Polaris Razor XP900 - side by side	900	2012	→	FDB2263	2		SG	FDB2236	2		SG
RZR-4 900 XP (EPS Models) - side by side	900	2011	→ 2015	FDB2263	2		SG	FDB2263	2		SG
Forest 1000	1000	2015	→ 2015	FDB2276	2		SG	FDB2276	2		SG
Ranger 1000 D Crew - side by side	1000	2015	→ 2015	FDB2263	2		SG	FDB2236	2		SG
Ranger 1000 D- side by side	1000	2015	→ 2015	FDB2263	2		SG	FDB2236	2		SG
RZR 1000 XP - side by side	1000	2014	→ 2015	FDB2263	2		SG	FDB2263	2		SG
RZR XP 4 Turbo	1000	2016	→	FDB2298	2		SG	FDB2263	2		SG
RZR XP Turbo	1000	2016	→	FDB2298	2		SG	FDB2263	2		SG
Scrambler 1000XP	1000	2015	→ 2015	FDB2276	2		SG	FDB2276	2		SG
Sportsman 1000 MD/XP	1000	2015	→ 2015	FDB2276	2		SG	FDB2276	2		SG

QUADZILLA

ZR 50	50	2007	→ 2009	FSB753				FDB313			SG/P/EF
BR 200	200	2007	→ 2008					FDB250			SG/P/EF
CUV 300 E 4x4 Side x Side	300	2008	→ 2009					FDB2121			SG
300 e XLC	300	2007	→ 2008	FDB314	2		ST/SG/P/EF	FDB314			ST/SG/P/EF
300 e XLC Stinger	300	2007	→ 2008	FDB314	2		ST/SG/P/EF	FDB314			ST/SG/P/EF
300 E Stinger	300	2009	→ 2011	FDB314	2		ST/SG/P/EF	FDB314			ST/SG/P/EF
Jow 300	300	2007	→ 2008	FDB314	2		ST/SG/P/EF	FDB314			ST/SG/P/EF
RL 300 Buggie	300	2009	→ 2011	FDB314	2		ST/SG/P/EF	FDB314			ST/SG/P/EF
CVT 320 e Parking brake	320	2007	→ 2011					FDB2121			SG

* It is recommended that in those applications where sintered pads are supplied as Original Equipment, replacement pads should also be of sintered composition.

** To avoid brake imbalance sintered pads fitted in rear calipers should only be used in combination with front calipers containing sintered pads.

2010



	CC	KW	FROM -> TO	N° SET	L/R	COMPOUND	N° SET	L/R	COMPOUND
...QUADZILLA									
320 e 4x4 Parking brake	320		2007 → 2008	FDB2121		SG			
QZ 320 E 4x4	320		2009 → 2009				FDB2121		SG
QZ 450 Sport	450		2008 → 2009	FDB314	2	ST/SG/P/EF	FDB314		ST/SG/P/EF
CUV 500 Side X Side	500		2010 → 2011				FDB2193		SG
CUV 500 Side X Side Parking Brake	500		2010 → 2011				FDB2054		SG
QZ 500 E/ES 4x4	500		2009 → 2011				FDB2193		SG
QZ 500 E/ES 4x4 Parking brake	500		2009 → 2011	FDB2054		SG			
RL 500 Buggy	500		2008 → 2009	FDB736	2	ST/P	FDB736	2	ST/P
RL 500 MK 11 Buggy	500		2010 → 2011				FDB2193		SG
RS 5 4WD	500		2010 → 2011				FDB2193		SG
XLC 500	500		2010 → 2011	FDB314	2	ST/SG/P/EF	FDB314		ST/SG/P/EF
RS 6 4WD Left	600		2010 → 2011	FDB497	2	ST/SM/SG/P/EF			
RS 6 4WD Right	600		2010 → 2011	FDB631		ST/SM/SG/P/EF/AG			
Z6 4X4	600		2010 → 2013				FDB2193		SG
RS 7 4WD	700		2010 → 2011	FDB2184	2	SG/P	FDB314		ST/SG/P/EF
X7 R	700		2010 → 2011	FDB2184	2	SG/P	FDB314		ST/SG/P/EF
RS 8	800		2010 → 2011	FDB2184	2	SG/P	FDB314		ST/SG/P/EF
SUZUKI 3 WHEELERS									
ALT 50 D/E	50		1983 → 1984				FSB726		
ALT 125 D	125		1983 → 1984				FSB779		
ALT 125 E/F/G	125		1984 → 1986				FSB724		
ALT 185 F	185		1985 → 1987				FSB724		
SUZUKI ATV									
LT 50	50		1984 → 1987				FSB726		
LT-A 50 QUADSPORT	50		2002 → 2005	FSB727	2		FSB723		
LT-Z 50 QUADSPORT	50		2006 →	FSB727	2		FSB723		
LT 80 all models	80		1987 → 2007	FSB727	2		FSB776		
LT-Z 90 QUADSPORT	90		2006 →	FSB723	2		FSB776		
LT 125 D	125		1983 → 2000				FSB779		
LT 125 E	125		1984 → 2000				FSB724		
LT 125 F/G/H	125		1985 → 1987				FSB776		
LT 160 (All models)	160		1989 → 2004	FSB777	2		FSB724		
LT 185 E/F/G/H	185		1984 → 1987				FSB724		
LT 230 GEF/GEG QUADRUNNER	230		1985 → 1986				FSB724		
LT 230 S QUADSPORT	230		1985 → 1988	FDB2013	2	SG	FDB661		SG/P
LT 230 EH/EJ/EK/EL/EM/EN/EP	230		1986 → 1993	FDB2013	2	SG	FDB381		SG/P/EF
LT 230 S QUADSPORT	230		1989 →	FDB2013		SG	FDB381		SG/P/EF
LT-F 230 G/H	230		1986 → 1987				FSB724		
LT 250 EF	250		1985 → 1986				FSB782		
LT 250 R	250		1985 → 1986	FDB2013	2	SG	FDB381		SG/P/EF
LT 250 R	250		1987 → 1992	FDB2013	2	SG	FDB2016		SG
LT 250 S	250		1989 → 1990	FDB2013	2	SG	FDB381		SG/P/EF
LT-F 250 4WD QUADRUNNER	250		1987 → 2002				FSB782		
LT-F 250 K OZARK	250		2002 → 2007	FDB250	2	SG/P/EF			
LT-Z 250 K QuadSport	250		2004 → 2009	FDB381	2	SG/P/EF			
LT 300 E	300		1987 → 1989				FSB782		
LT-F 300 KING QUAD	300		1991 → 2001	FSB929	2		FSB782		
LT-F 300 KING QUAD	300		2002 →	FDB497		left	ST/SM/SG/P/EF		
LT-F 300 KING QUAD	300		2002 →	FDB631		right	ST/SM/SG/P/EF/AG		
LT-F 300 KING QUAD	300		2002 →				FSB782		
LT-A 400 F KING QUAD 4X4	400		2008 → 2011	FDB2307		left	SG		
LT-A 400 F KING QUAD 4X4	400		2008 → 2011	FDB2308		right	SG		
LT-A 400 F KING QUAD 4X4	400		2008 → 2011				FSB725		
LT-A/F 400 EIGER (All models)	400		2002 → 2008	FDB250	2		SG/P/EF		FSB725
LT-F 400 X	400		1991 → 2000	FSB929	2				FSB784
LT-F 400 KING QUAD 4X2	400		2008 → 2010	FDB2307		left	SG		
LT-F 400 KING QUAD 4X2	400		2008 → 2010	FDB2308		right	SG		
LT-F 400 KING QUAD 4X2	400		2008 → 2010				FSB725		
LT-F 400 KING QUAD FS 4X4	400		2008 → 2012	FDB2307		left	SG		
LT-F 400 KING QUAD FS 4X4	400		2008 → 2012	FDB2308		right	SG		
LT-F 400 KING QUAD FS 4X4	400		2008 → 2012				FSB725		
LT-Z 400 QUADSPORT	400		2003 → 2012	FDB381	2		SG/P/EF		SG
LT-A 450 X KING QUAD 4X4	450		2007 → 2010	FDB2307		left	SG		
LT-A 450 X KING QUAD 4X4	450		2007 → 2010	FDB2308		right	SG		
LT-A 450 X KING QUAD 4X4	450		2007 → 2010				FDB2016		SG
LT-R 450 K/Z	450		2006 →	FDB497		left	ST/SM/SG/P/EF		
LT-R 450 K/Z	450		2006 →	FDB631		right	ST/SM/SG/P/EF/AG		
LT-R 450 K/Z	450		2006 →				FDB2016		SG

* It is recommended that in those applications where sintered pads are supplied as Original Equipment, replacement pads should also be of sintered composition.

** To avoid brake imbalance sintered pads fitted in rear calipers should only be used in combination with front calipers containing sintered pads.



CC KW FROM -> TO N° SET L/R COMPOUND N° SET L/R COMPOUND

...SUZUKI ATV

LT-R 450 Z Quad Racer	450	2008 →						FDB2016			SG
LT 500 R	500	1987 → 1990	FDB2013	2		SG		FDB2016			SG
LT-A 500 F QUADMASTER	500	2000 → 2001	FDB497		left	ST/SM/SG/P/EF					
LT-A 500 F QUADMASTER	500	2000 → 2001	FDB631		right	ST/SM/SG/P/EF/AG					
LT-A 500 F QUADMASTER	500	2000 → 2001						FSB782			
LT-A 500 KING QUAD XP	500	2009 → 2012	FDB2307		left	SG					
LT-A 500 KING QUAD XP	500	2009 → 2012	FDB2308		right	SG					
LT-A 500 KING QUAD XP	500	2009 → 2012						FDB2016			SG
LT-A 500 KING QUAD X	500	2012 → 2012	FDB2307		left	SG					
LT-A 500 KING QUAD X	500	2012 → 2012	FDB2308		right	SG					
LT-A 500 KING QUAD X	500	2012 → 2012						FDB2016			SG
LT-A/F 500 FK VINSON 4WD	500	2002 → 2002	FDB250	2		SG/P/EF					
LT-A/F 500 FK VINSON 4WD	500	2003 → 2007	FDB250	2		SG/P/EF		FDB828			ST/P
LT-F 500 FW/FX/F1 QUADRUNNER (left)	500	1998 → 2002	FDB497			ST/SM/SG/P/EF		FSB782			
LT-F 500 FW/FX/F1 QUADRUNNER (right)	500	1998 → 2002	FDB631			ST/SM/SG/P/EF/AG					
LT-A 700 KING QUAD	700	2005 → 2007	FDB2307		left	SG					
LT-A 700 KING QUAD	700	2005 → 2007	FDB2308		right	SG					
LT-A 700 KING QUAD	700	2005 → 2007						FDB2016			SG
TWIN PEAKS 700	700	2004 → 2005	FDB2307		left	SG					
TWIN PEAKS 700	700	2004 → 2005	FDB2308		right	SG					
LT-A 750 KING QUAD X	750	2008 → 2012	FDB2307		left	SG					
LT-A 750 KING QUAD X	750	2008 → 2012	FDB2308		right	SG					
LT-A 750 KING QUAD X	750	2008 → 2012						FDB2016			SG
LT-A 750 KING QUAD XP	750	2009 → 2012	FDB2307		left	SG					
LT-A 750 KING QUAD XP	750	2009 → 2012	FDB2308		right	SG					

SYM ATV

Quadlander 200	200	2012 → 2013	FDB2184	2		SG/P		FDB2226			EF/AG
Trackrunner 200 Quad	200	2005 → 2009	FDB2184	2		SG/P		FDB2226			EF/AG
Quadlander 250	250	2005 → 2009	FDB2184	2		SG/P		FDB2226			EF/AG
Citymax 300 Quad	300	2006 →	FDB2184	2		SG/P		FDB2226			EF/AG
Quadlander 300	300	2007 → 2010	FDB2184	2		SG/P		FDB2184			SG/P
Quadlander 300 S	300	2007 →	FDB2184	2		SG/P		FDB2184			SG/P
Quadlander 600	600	2008 → 2010	FDB250	2		SG/P/EF		FDB2184			SG/P
Quadraider 600	600	2006 → 2007	FDB250	2		SG/P/EF		FDB2184			SG/P
Quadraider 600	600	2008 →	FDB2184	2		SG/P		FDB2184			SG/P
Quadraider 600LE	600	2010 →	FDB2184	2		SG/P		FDB2184			SG/P

TGB ATV

Hornet 50 Quad	50	2004 → 2005	FSB756	2				FDB313			SG/P/EF
Hornet 90 Quad	90	2004 → 2005	FSB756	2				FDB313			SG/P/EF
250Blade/Congo ATV	250	2006 → 2007	FDB314	2		ST/SG/P/EF		FDB313			SG/P/EF
Blade325 Quad (4x2)	325	2007 → 2011	FDB313	2		SG/P/EF		FDB314			ST/SG/P/EF
Blade325 LE Quad (4x2)	325	2008 → 2010	FDB313	2		SG/P/EF		FDB314			ST/SG/P/EF
Blade325 SL Quad (4x2)	325	2011 → 2012	FDB313	2		SG/P/EF		FDB314			ST/SG/P/EF
Target325 (4X2)	325	2009 → 2012	FDB313	2		SG/P/EF		FDB314			ST/SG/P/EF
Avenger400 Quad (4x2)	400	2007 → 2009	FDB2184	2		SG/P		FDB2184	2		SG/P
Avenger400 LE Quad (4x2)	400	2009 → 2010	FDB2184	2		SG/P		FDB2184	2		SG/P
Target400 (4X2)	400	2009 → 2010	FDB313	2		SG/P/EF		FDB314			ST/SG/P/EF
Blade(4x4) 425 Quad	425	2007 → 2009	FDB2184	2		SG/P		FDB2184	2		SG/P
BladeSE (4x4) 425 Quad	425	2009 → 2010	FDB2184	2		SG/P		FDB2184	2		SG/P
Outback 425 C 4x4	425	2007 → 2009	FDB2184	2		SG/P		FDB2184			SG/P
Outback 425 Real Tree Camo Edition 4x4 Auto	425	2007 → 2009	FDB2184	2		SG/P		FDB2184			SG/P
Outback 425 SE 4x4 Auto	425	2007 → 2009	FDB2184	2		SG/P		FDB2184			SG/P
Target425 (4X4)	425	2009 → 2011	FDB313	2		SG/P/EF		FDB314			ST/SG/P/EF
Blade450 SE (4x4)	450	2010 → 2011	FDB2184	2		SG/P		FDB314			ST/SG/P/EF
Blade460 R Target	460	2012 →	FDB313	2		SG/P/EF		FDB314			ST/SG/P/EF
Blade460 SL IRS 4x4	460	2012 →	FDB2184	2		SG/P		FDB314			ST/SG/P/EF
Avenger500 R Quad (4x2)	500	2009 → 2010	FDB2184	2		SG/P		FDB2184	2		SG/P
Target500 (4X2)	500	2009 → 2010	FDB313	2		SG/P/EF		FDB314			ST/SG/P/EF
Blade510 LE	510	2011 → 2012	FDB2184	2		SG/P		FDB314			ST/SG/P/EF
525SE 4X4	525	2009 →	FDB2184	2		SG/P		FDB314			ST/SG/P/EF
Blade525 SE 4X4	525	2009 → 2010	FDB2184	2		SG/P		FDB2184	2		SG/P
Blade525 SL 4X4	525	2009 → 2010	FDB2184	2		SG/P		FDB314			ST/SG/P/EF
Target525 (4X4)	525	2009 → 2011	FDB313	2		SG/P/EF		FDB314			ST/SG/P/EF
Blade550 SE 4X4	550	2009 → 2011	FDB2184	2		SG/P		FDB314			ST/SG/P/EF
Blade550 SL 4X4	550	2009 → 2010	FDB2184	2		SG/P		FDB314			ST/SG/P/EF
550IRS Blade LT	550	2010 → 2012	FDB2184	2		SG/P		FDB314			ST/SG/P/EF
Blade550 LT 4X4	550	2010 → 2011	FDB2184	2		SG/P		FDB314			ST/SG/P/EF
Blade550 IRS Target	550	2011 → 2012	FDB2184	2		SG/P		FDB314			ST/SG/P/EF

* It is recommended that in those applications where sintered pads are supplied as Original Equipment, replacement pads should also be of sintered composition.

** To avoid brake imbalance sintered pads fitted in rear calipers should only be used in combination with front calipers containing sintered pads.

2012



CC KW FROM -> TO N° SET L/R COMPOUND N° SET L/R COMPOUND

...TGB ATV

Gunner550 4 X 4 Target	550	2010 → 2012	FDB2184	2		SG/P	FDB2184	2		SG/P
------------------------	-----	-------------	---------	---	--	------	---------	---	--	------

UM ATV

Moontrax 50 R	50	2003 → 2006					FDB313			SG/P/EF
Earthlander 90 R	90	2005 → 2006					FDB313			SG/P/EF
Moontrax 90 R	90	2003 → 2006					FDB313			SG/P/EF
Earthlander 200	200	2005 → 2006					FDB313			SG/P/EF
MTX 450	450	2008 →	FDB250	2		SG/P/EF	FDB250			SG/P/EF

YAMAHA 3 WHEELERS

YT 60 L/N TRI-ZINGER	60	1984 → 1985					FSB738			
YT 125 G/H/J/K/L/N	125	1980 → 1985					FDB2014			SG
YT 175 J/K	175	1982 → 1983	FSB731				FDB2014			SG
YTM 200 EK/EL	200	1983 → 1984	FSB731				FDB2014			SG
YTM 200 K/L/N	200	1983 → 1985	FSB731				FDB2014			SG
YTM 200 ERN	200	1985 → 2000	FSB731				FDB2014			SG
YTM 225 DXK/DXL/DXN	225	1983 → 1985	FSB731				FDB2014			SG
YTM 225 DRN/DRS	225	1985 → 1986	FSB731				FDB2014			SG
YTZ 250 N/S	250	1985 → 1986	FDB383			SG/P/EF	FDB383			SG/P/EF

YAMAHA ATV

YFM 50 RAPTOR	50	2004 → 2007	FSB731	2			FSB947			
YF 60 S (MOTO4)	60	1986 → 2000					FSB738			
YFM 80 N/S (MOTO4)	80	1985 → 1986					FSB733			
YFM 80 T/U	80	1987 → 1988	FSB738	2			FSB733			
YFM 80 BADGER	80	1992 → 2001	FSB731	2			FSB947			
YFM 80 RAPTOR	80	2002 → 2008	FSB731	2			FSB947			
YFM 80 GRIZZLY	80	2005 → 2008	FSB731	2			FSB947			
YFM 90 R Raptor (No Rear Parking Brake)	90	2009 → 2009					FDB313			SG/P/EF
YFM 90 R Raptor (with Rear Parking Brake)	90	2010 → 2013					FDB314			ST/SG/P/EF
YFM 100 T/U CHAMP	100	1987 → 1988	FSB738	2			FSB733			
YFM 100 W/A/B CHAMP	100	1989 → 1991	FSB731	2			FSB733			
YFA1 125 BREEZE	125	1989 → 1991	FSB731	2			FSB733			
YFA1 125 BREEZE	125	1992 → 2004	FSB731	2			FSB947			
YFM 125 GRIZZLY	125	2004 → 2010	FSB731	2			FSB947			
YFM 200 (Moto 4)	200	1985 → 1989	FSB731	2			FDB2014			SG
YFS 200 BLASTER	200	1988 → 2002	FSB731	2						
YFS 200 BLASTER	200	2003 → 2006	FDB250	2		SG/P/EF	FDB381			SG/P/EF
YFM 225 (Moto 4)	225	1986 → 1988	FSB731	2			FDB2014			SG
YFB 250 D/E/F TIMBERWOLF	250	1992 → 1994	FSB731	2			FSB948			
YFB 250 FW TIMBERWOLF	250	1994 → 2000	FSB948	2			FSB948			
YFB 250	250	1995 → 1998	FSB948	2			FSB948			
YFM 250 W/A/B	250	1989 → 1991	FSB948	2			FDB2014			SG
YFM 250 BEAR TRACKER	250	1999 → 2000	FSB948	2			FSB948			
YFM 250 BEAR TRACKER	250	2001 → 2004	FDB381	2		SG/P/EF	FSB948			
YFM 250 BRUIN	250	2005 → 2006	FDB250	2		SG/P/EF	FSB946	2		
YFM 250 Big Bear	250	2007 → 2009	FDB250	2		SG/P/EF	FSB946	2		
YFM 250 R Raptor	250	2008 →	FDB2231		left	SG				
YFM 250 R Raptor	250	2008 →	FDB2230		right	SG				
YFM 250 R Raptor	250	2008 →					FDB381			SG/P/EF
YFM 250 RSPX Special Edition Custom	250	2008 →	FDB2231		left	SG				
YFM 250 RSPX Special Edition Custom	250	2008 →	FDB2230		right	SG				
YFM 250 RSPX Special Edition Custom	250	2008 →					FDB381			SG/P/EF
YFM 350 ERT/ERU	350	1987 → 1988	FSB928	2			FDB2014			SG
YFM 350 FW T/U	350	1987 → 1988	FSB928	2			FDB2014			SG
YFM 350 FW T/U BIG BEAR	350	1987 → 1988	FSB928	2			FDB2014			SG
YFM 350 XT/XU WARRIOR	350	1987 → 1988	FDB383	2		SG/P/EF	FDB250			SG/P/EF
YFM 350 ER W/A/D	350	1989 → 1992	FSB767	2			FDB2014			SG
YFM 350 FW W/A/B/D/E/F/G BIG BEAR	350	1989 → 1995	FSB933	2			FDB2014			SG
YFM 350 XW-XS WARRIOR	350	1989 → 2004	FDB250	2		SG/P/EF	FDB381			SG/P/EF
YFM 350 ER E/F/G	350	1993 → 1995	FSB933	2			FDB2014			SG
YFM 350 FX WOLVERINE	350	1995 → 2007	FDB250	2		SG/P/EF	FDB381			SG/P/EF
YFM 350 FW H/J/K BIG BEAR	350	1996 → 1998	FSB933	2						
YFM 350 FW 4WD BIG BEAR	350	1999 → 2003	FDB250	2		SG/P/EF				
YFM 350 BRUIN (All Models)	350	2004 → 2006	FDB250	2		SG/P/EF				
YFM 350 RAPTOR	350	2004 → 2010	FDB381	2		SG/P/EF	FDB381			SG/P/EF
YFM 350 X Wolverine	350	2006 → 2009	FDB250	2		SG/P/EF	FSB946	2		
YFM 350 2x4 Grizzly	350	2007 → 2010	FDB250	2		SG/P/EF	FDB381			SG/P/EF
YFM 350 4x4 Grizzly	350	2007 → 2010	FDB250	2		SG/P/EF	FSB946	2		

* It is recommended that in those applications where sintered pads are supplied as Original Equipment, replacement pads should also be of sintered composition.

** To avoid brake imbalance sintered pads fitted in rear calipers should only be used in combination with front calipers containing sintered pads.



	CC	KW	FROM -> TO		N° SET	L/R	COMPOUND		N° SET	L/R	COMPOUND
...YAMAHA ATV											
YFP 350 U Terrapro	350		1988 →	FSB948	2						
YFZ 350 T/U/W BANSHEE	350		1987 → 1989	FDB383	2		SG/P/EF	FDB381			SG/P/EF
YFZ 350 A/B/D/E/F BANSHEE	350		1990 → 2006	FDB250	2		SG/P/EF	FDB381			SG/P/EF
YFM 400 FW KODIAK	400		1993 → 1998	FSB933	2						
YFM 400 FW KODIAK	400		1999 → 2000	FDB250	2		SG/P/EF	FSB948			
YFM 400 BIG BEAR (All Models)	400		2000 → 2007	FDB250	2		SG/P/EF	FSB736			
YFM 400 FW KODIAK (All Models except AUTO)	400		2000 → 2006	FDB250	2		SG/P/EF	FDB2148			SG/EF
YFM 400 KODIAK AUTO	400		2003 →	FDB250	2		SG/P/EF				
YFM 400 4x4 Grizzly	400		2007 → 2008	FDB250	2		SG/P/EF	FDB2148			SG/EF
YFM 450 KODIAK	450		2003 → 2006	FDB250	2		SG/P/EF	FDB2148			SG/EF
YFM 450 WOLVERINE (All models)	450		2006 → 2010	FDB250	2		SG/P/EF	FDB2148			SG/EF
YFM 450 Grizzly (All models)	450		2007 → 2010	FDB250	2		SG/P/EF	FDB2148			SG/EF
YFZ 450	450		2004 → 2005	FDB497		left	ST/SM/SG/P/EF				
YFZ 450	450		2004 → 2005	FDB631		right	ST/SM/SG/P/EF/AG				
YFZ 450	450		2004 → 2005					FDB381			SG/P/EF
YFZ 450 - All models	450		2006 →	FDB497		left	ST/SM/SG/P/EF				
YFZ 450 - All models	450		2006 →	FDB631		right	ST/SM/SG/P/EF/AG				
YFZ 450 - All models	450		2006 →					FDB2119			SM/SG/P/EF/AG
YXR 450 RHINO - side by side	450		2004 → 2009	FDB497		left	ST/SM/SG/P/EF				
YXR 450 RHINO - side by side	450		2004 → 2009	FDB631		right	ST/SM/SG/P/EF/AG				
YXR 450 RHINO - side by side	450		2004 → 2009					FDB2149			SG
YFM 550 4x4 Grizzly	550		2008 →	FDB2231		left	SG	FDB2233		left	SG
YFM 550 4x4 Grizzly	550		2008 →	FDB2230		right	SG	FDB2232		right	SG
YFM 600 GRIZZLY (All)	600		1998 → 2001	FDB381	2		SG/P/EF				
YFM 660 RAPTOR	660		2001 → 2005	FDB381	2		SG/P/EF	FDB381			SG/P/EF
YFM 660 GRIZZLY	660		2002 → 2008	FDB381	2		SG/P/EF	FDB2193			SG
YFM 660 Ducks Unlimited Ed.-side by side	660		2006 → 2007	FDB381			SG/P/EF	FDB2193			SG
YXR 660 RHINO - side by side	660		2004 → 2007	FDB497		left	ST/SM/SG/P/EF				
YXR 660 RHINO - side by side	660		2004 → 2007	FDB631		right	ST/SM/SG/P/EF/AG				
YXR 660 RHINO - side by side	660		2004 → 2007					FDB2149			SG
YFM 700 RAPTOR - All Models	700		2006 →	FDB497		left	ST/SM/SG/P/EF				
YFM 700 RAPTOR - All Models	700		2006 →	FDB631		right	ST/SM/SG/P/EF/AG				
YFM 700 RAPTOR - All Models	700		2006 →					FDB2235			SG
YFM 700 Ducks Unlimited Edition	700		2007 → 2009	FDB2231		left	SG	FDB2233		left	SG
YFM 700 Ducks Unlimited Edition	700		2007 → 2009	FDB2230		right	SG	FDB2232		right	SG
YFM 700 GRIZZLY	700		2008 →	FDB2231		left	SG	FDB2233		left	SG
YFM 700 GRIZZLY	700		2008 →	FDB2230		right	SG	FDB2232		right	SG
YXC 700 E Viking VI EPS	700		2015 → 2016	FDB2301		left	SG				
YXC 700 E Viking VI EPS	700		2015 → 2016	FDB2302		right	SG				
YXM 700 ES Viking EPS SE	700		2014 → 2016	FDB2301		left	SG				
YXM 700 ES Viking EPS SE	700		2014 → 2016	FDB2302		right	SG				
YXM 700 E Viking EPS COMO	700		2016 →	FDB2301		left	SG				
YXM 700 E Viking EPS COMO	700		2016 →	FDB2302		right	SG				
YXM 700 E Wolverine R	700		2016 →	FDB2301		left	SG				
YXM 700 E Wolverine R	700		2016 →	FDB2302		right	SG				
YXR 700 RHINO - side by side	700		2008 →	FDB631		left	ST/SM/SG/P/EF/AG	FDB631		left	ST/SM/SG/P/EF/AG
YXR 700 RHINO - side by side	700		2008 →	FDB497		right	ST/SM/SG/P/EF	FDB497		right	ST/SM/SG/P/EF
YXR 700 RHINO 4X4 SE (Parking brake)	700		2009 →	FDB2270			P				
YXR 700 FA/FB/FD RHINO Side x Side (Parking brake)	700		2011 → 2013	FDB2270			P				

ALL TERRAIN

* It is recommended that in those applications where sintered pads are supplied as Original Equipment, replacement pads should also be of sintered composition.

** To avoid brake imbalance sintered pads fitted in rear calipers should only be used in combination with front calipers containing sintered pads.

2014



	CC	KW	FROM -> TO	N° SET	L/R	COMPOUND		N° SET	L/R	COMPOUND
LYN SNOWMOBILE										
Enduro			1998 → 2000					FDB2136		SG
GLX 5009 ST			1998 → 2000					FDB2136		SG
Rave Special			1998 → 2000					FDB2136		SG
Gran Touring 700	700		1998 → 2000					FDB2136		SG
POLARIS SNOWMOBILE										
ALL MODELS WITH PHANTOM BRAKES			2003 →					FDB2189		SG
HAYES (all models)			1993 → 1998					FDB2001		SG/PRP/P
INDY RXL - RMK - SKS			1993 → 1997					FDB2001		SG/PRP/P
INDY SPORT - TOURING			1993 → 1998					FDB2001		SG/PRP/P
INDY TRAIL - DE LUXE			1993 → 1998					FDB2001		SG/PRP/P
INDY XLT (all models)			1993 → 1998					FDB2001		SG/PRP/P
INDY TRANSPORT			1996 → 1998					FDB2001		SG/PRP/P
INDY ULTRA (all models)			1996 → 1998					FDB2001		SG/PRP/P
INDY 440 XCR	440		1993 → 1999					FDB2001		SG/PRP/P
XCF 440	440		1998 → 2000					FDB2001		SG/PRP/P
INDY 600 XCR - SP	600		1996 → 1999					FDB2001		SG/PRP/P
SKI DOO SNOWMOBILE										
REV XP			2008 →	FDB2243		SG/P				
YAMAHA SNOWMOBILE										
EXCEL V			1979 → 1980	FDB2014		SG				
EXCITER			1976 → 2000	FDB2014		SG				
GPX (All Models)			1974 → 1975	FDB2014		SG				
NISSIN (all models)			1997 → 1999				FDB2111			ST/P/EF
OVATION			1989 → 1993	FDB2014		SG				
PHAZER			1984 → 1993	FDB2014		SG				
SNO-SCOOT			1989 → 1991	FDB2014		SG				
SPV			1980 → 1991	FDB2014		SG				
SSR			1978 → 2000	FDB2014		SG				
V-MAX			1983 → 1991	FDB2014		SG				
XL-V			1985 → 1990	FDB2014		SG				
SS 440	440		1980 → 1993	FDB2014		SG				
VK X 440	440		1989 → 1991	FDB2014		SG				
SX 500R	500		→				FDB2111			ST/P/EF
V-MAX 500 (all)	500		1997 → 1999				FDB2111			ST/P/EF
VENTURE 500	500		1997 → 2000				FDB2111			ST/P/EF
SRX 600	600		1998 → 1999				FDB2111			ST/P/EF
SX 600R	600		→				FDB2111			ST/P/EF
V-MAX 600 (all)	600		1997 → 1999				FDB2111			ST/P/EF
VENTURE 600	600		1997 → 2000				FDB2111			ST/P/EF
SRX 700	700		1998 → 1999				FDB2111			ST/P/EF
SRX 700 - MOUNTAIN MAX 700	700		2000 → 2001				FDB2111			ST/P/EF
SX 700R	700		→				FDB2111			ST/P/EF
V-MAX 700 (all)	700		1997 → 1999				FDB2111			ST/P/EF
VENTURE 700	700		1997 → 2000				FDB2111			ST/P/EF
V-MAX 800	800		1998 → 2000				FDB2111			ST/P/EF

* It is recommended that in those applications where sintered pads are supplied as Original Equipment, replacement pads should also be of sintered composition.
 ** To avoid brake imbalance sintered pads fitted in rear calipers should only be used in combination with front calipers containing sintered pads.





PADS FOR RACING CALIPERS



PADS FOR RACING CALIPERS

PASTIGLIE PER PINZE DA COMPETIZIONE

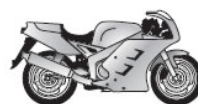
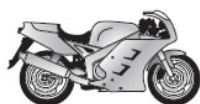

...AMERICAN IRONHORSE

American Ironhorse 6 Pot	FDB2036
American Ironhorse PM caliper 4 pot	FDB2040

AP RACING

CP2044 (4 Piston) early w/ tabs	FRP410
CP2195 (2 Piston)	FDB342
CP2696 (2 Piston)	FDB342
CP3086 (4 Piston) radial narrow-band	FRP410
CP4466/4477 (6 Piston)	FDB2167
CP4485 (4 Piston)	FRP410

AP/LOCKHEED

4 Piston Radial Mount CP6688 (4 pads required)	FDB2166
--	---------

BERINGER

4 Piston	FDB574
6 Piston	FDB207
6 Piston	FDB2036

BRAKING

Braking Systems 4 Pot; Twin Pin	FDB2042
---------------------------------	---------

BREMBO

2 Piston P2 34 XA0xxx radial mount (2 pads required)	FDB2166
2-Piston (F04 twin pin w/tabs)	FRP405
2-Piston (F08/P108)	FDB108
2-Piston (F08/P108)	FDB148
2-Piston, new for 1997 (P32G)	FDB2074
2-Piston/Large (F09)	FDB204
2-Piston/Small (F05)	FDB207
2-Piston/Small (P30A)	FDB889
220.9885.30 High Perf. Kit Ducati models (100 mm distance)	FDB2260
220.A397.10 High Perf. kit Japanese models (108 mm distance)	FDB2260
220A01610	FDB2042
4 Piston P34/34 X00.C04&X99C4 radial mount (4 pads required)	FDB2166
4-Piston Radial mount Billet HP w/ 108mm centers	FDB2042
4-Piston/2 pads; Narrow (GP32/36-mono), 10mm	FDB2123
4-Piston; 8mm pad (P3034)	FRP408
4-Piston; Twin Pin Wide Mount 65mm	FDB2042
Brembo Racing, Billet 2x24mm rear: GP24 (2 piston)	FDB2171
Brembo Racing, Billet 4x24mm rear: GP4-24 (4 piston)	FDB2170
Brembo Racing, Billet rear	FDB2122
GP Type XA3.J7&XA8.Y3 Radial Mount (Pinless Fixing)	FDB2228
GP4 RR (code XA93310/11)	FDB2123
P4 34 Axial caliper Four Pads XA32950	FDB2215
P4 34 Axial caliper Four Pads XA32950	FDB2120
Radial Caliper M4.32	FDB2265
SBK Racing DX XB0.B1.31, SX XB0.B1.30 (P4 30/34)	FDB2278
XA93310/11 4-Piston/2 pads; Narrow (GP32/36-2pc), 8.3mm	FDB2007

EBC

4 Piston	FDB2041
----------	---------

FD (DISCACCIATI)

4-Piston	FRP408
6-Piston	FDB873
6-Piston - 9,5mm thick version	FDB2144

FLORIDA CALIPER

4-Piston (Th. 10.7mm)	FDB449
4-Piston (Th. 8.8mm)	FDB662
6-Piston (Harrison)	FRP415

FONTANA

2-Piston	FDB342
----------	--------

GMA

A Series (2-Piston)	FDB151
B Series (2-Piston)	FDB205
BP Series	FDB784
F Series (4-Piston)*	FRP405
Inside/Outside Pulley	FDB2100
S Series (6-Piston)	FDB864

GRIMECA

2-Piston, Castle Top: 1025-1	FDB698
2-Piston, Castle Top: small	FDB697
2-Piston, Castle Top: small	FDB694
2-Piston, medium (four tab, 1010)	FDB205
2-Piston, small (four tab, 1000T)	FDB213
2-Piston, Twin Pin: 1005T	FDB436
2-Piston, Twin Pin: 1025-2	FDB696
2-Piston, Twin Pin: 1050/55	FRP213
6-Piston, Castle Top: 911-755	FDB784

HARRISON BILLET

4 Piston new style	FRP415
4 Piston old style	FDB207
6 Piston new style	FRP415
6 Piston old style	FDB207
MINI 6 (6-Piston) **	FRP415

HAWG HALTERS

4 Pot	FDB2040
6 Pot	FDB2036

HONDA

Honda 4 Piston, Brembo / Honda RS	FDB858
Honda 4 Piston, Nissin	FDB533

ISR

2-Piston (22-027)	FRP416
2-Piston (22-029)	FDB207
2-Piston (22-030)	FRP405

PADS FOR RACING CALIPERS

PASTIGLIE PER PINZE DA COMPETIZIONE

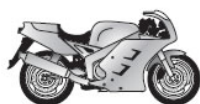

...ISR

4-Piston (22-025) *	FRP416
6-Piston, Large **	FRP415

JAYBRAKE

2 & 4* Piston, large	FDB205
2 & 4* Piston, small	FRP405

KELGATE

2 & 4-Piston	FDB342
2 & 4-Piston	FRP213
6-Piston	FDB2091

LEGENDS/NOVA

4-Piston	FDB2040
----------	---------

LOCKHEED

2-Piston	FDB342
4-Piston, 8mm	FRP410
6-Piston (new for 2003)	FDB2167
Radial Mount 4 pot (new '04)	FDB2168

MAGURA

4-Piston Radial Mount	FDB2164
4-Piston Radial Mount	FDB2162
4-Piston Radial Mount	FDB2268

MOTO-MASTER

4-Piston	FDB574
----------	--------

NISSIN

Nissin 2pot rear (TZ250, others)	FDB2194
Nissin 4Pot Axial Mnt Racing/billet	FDB858
Nissin 4Pot Radial Mount/billet	FDB2209
Nissin 4Pot Radial Mount/cast two piece	FDB2158
Nissin 6 Piston Racing	FDB2036

PEGASUS

Small Caliper	FRP405
---------------	--------

PERFORMANCE MACHINE

112x6 6-Piston	FDB2036
125x2 2-Piston	FRP405
125x4R 4-Piston; 8mm pad	FDB2040
125x4S 4-Piston *	FRP405
125x4SL 4 Piston *	FRP405
125x6 6-Piston	FDB864
137x4 4-Piston; 11mm pad	FDB2041
137x6 6-Piston	FDB847
162x2 2-Piston	FDB134

PFM

Kawasaki SBK caliper 2009	FDB2167
---------------------------	---------

Narrow Blade Billet 6-Piston - Superbike

FDB2167

PRO-ONE

Pro -One 4-Piston - Old	FDB781
Pro-One 2-Piston - Old	FDB207
Pro-One 4-Piston - New	FDB574
Pro-One 6-Piston - New **	FDB207

PVM

2-Piston, rear Caliper (2 pads required)	FDB2166
4 Piston Radial Mount Caliper (4 pads required)	FDB2166
4-Piston, 2 piece caliper, 2pad x 8mm	FDB2007
4-Piston, mono blok, 2pad x 10mm	FDB2123

REVTECH® / CUSTOM CHROME

RevTech / CCI 4 Pot (CCI #18475)	FRP408
----------------------------------	--------

SPIEGLER

4-Piston	FDB2033
8-Piston	FDB887

SPONDON

Spondon 2 Piston	FDB342
Spondon 4 Piston (w/ lugs removed)	FRP410

THUNDERHEART

4-Piston	FDB2040
----------	---------

WILWOOD

4-Piston (GP300/310)	FRP408
DH4 Calipers	FDB2176
GP 200 Calipers	FDB250
PS-1 Calipers	FDB2175



A hand wearing a black leather motorcycle glove is pointing towards a technical drawing on a white surface. The drawing is partially visible and shows a grid pattern. The background is dark, creating a high-contrast scene.

FERODO[®]

PAD DRAWINGS & BUYER'S GUIDE

FERODO[®]

MOTORCYCLE

FRP213

59.5 x 54.4 x 10.2 mm

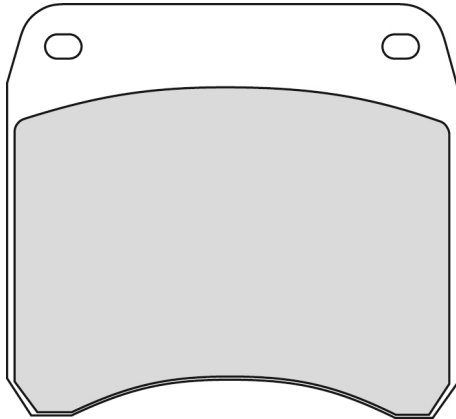

MATERIAL AVAILABILITY											
AG	EF	P	PRP	ST	SM	SG	ZR	XRAC	ZRAC	CP1	CPRO
		✓									✓

Pinze / Calipers

Grimeca

2-Piston, Twin Pin: 1050/55

Kelgate

2 & 4-Piston

CROSS REFERENCE

CL BRAKES	2959
EBC	FA016
VESRAH	VD-906

		CC	KW	FROM	TO	FRONT / REAR	LEFT / RIGHT
	TRIUMPH						
	M BONNEVILLE T 400 V E	400		1982	1984	F	
	M TRIDENT TI 500 V	500		1982	1984	F	
	M THUNDERBIRD 650	650		1982	1984	F	

		CC	KW	FROM	TO	FRONT / REAR	LEFT / RIGHT
	M BONNEVILLE 750 TWIN (Lockheed calipers)	750		1982	1984	F	
	M TIGER 750 TR 7V	750		1976	1981	F	

4000

FRP405

36.1 x 45.1 x 6.0 mm

replacing FDB2107AG- July 2016: AG compound superseded by EF

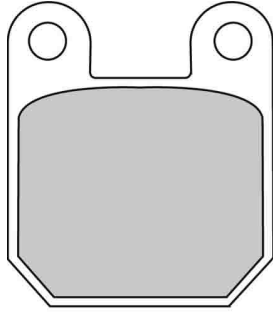

MATERIAL AVAILABILITY											
AG	EF	P	PRP	ST	SM	SG	ZR	XRAC	ZRAC	CP1	CPR0
X	✓	✓	✓	✓		✓					

ALSO AVAILABLE

SHAPE	TH. MM	NOTES
FDB2107		with tab

Pinze / Calipers

BREMBO

2-Piston (F04 twin pin w/tabs)

GMA

F Series (4-Piston)*

ISR

2-Piston (22-030)

Jaybrake

2 & 4* Piston, small

Pegasus

Small Caliper

Performance Machine

125x2 2-Piston

125x4S 4-Piston *

125x4SL 4 Piston *

CROSS REFERENCE

BRAKING	621
BREMBO	07044
BREMBO	07BB12
BREMBO	7044
BRENTA	3015
BRENTA	4015
CL BRAKES	2377
CL BRAKES	3015
CL BRAKES	3016
EBC	FA115
GALFER	FD065
GOLD FREN	121
LUCAS/TRW	MCB535
NEWFREN	FD0094
SBS	105
SBS	559
VESRAH	VD-254
VESRAH	VD-946

		CC	KW	FROM	TO	FRONT / REAR	LEFT / RIGHT	
	APRILIA	M RS 50	50	2006	2011	R		
		M RX 50	50	2003	2014	R		
		M RX 50 Enduro	50	1995	2003	R		
		M SX 50	50	2008	2013	R		
		M TX 125 M	125	1986		F		
		M TX 300	300	1986		F		
		M TX 300 M	300	1986		F		
		M TX 311 M	312	1987		F		
		M TX 312 M	312	1988		F		
		M TX 312 M	312	1988		R		
		M TXR 312 M	312	1988		F		
		M TXR 312 M	312	1988		R		
		ATK (USA)	M all models 1987		1987		R	
		BETA	S EIKON 50	50	1999		F	
		S EIKON 50	50	1999		R		
		M Pro Race 50	50	2005		F		
		M REV 50	50	2000		F		
		M REV 50	50	2000		R		
		M RR 50 PRO RACE	50	1998		R		
		M RR 50 all models	50	1999		R		
		M RR 50 Standard	50	2005	2008	R		
		M RR 50 Enduro Standard	50	2009	2012	F		
		M RR 50 Motard Standard	50	2009	2012	F		
		M SUPERMOTARD 50	50	2000		F		
		M SUPERMOTARD 50	50	2000		R		
		M SUPERTRIAL 50	50	1992		F		
		M SUPERTRIAL 50	50	1992		R		
		M TECHNO 50	50	1996		F		
		M TECHNO 50	50	1996		R		
		M TR 50 (SPAIN)	50	1989		F		
		M EVO 80 Junior	80	2009	2012	F		

		CC	KW	FROM	TO	FRONT / REAR	LEFT / RIGHT
		M EVO 80 Junior	80	2009	2012	R	
		M REV 80	80	2000	2007	F	
		M REV 80	80	2000	2007	R	
		M ALP 125 4T	125	1999	2003	F	
		M ALP 125 4T	125	1999	2003	R	
		M R 125 4T (Pit Bike)	125	2008		R	
		M RE 125 4T Enduro	125	2010	2012	F	
		M TR 35 125	125	1990		F	
		M TR 35 125	125	1990		R	
		M TRIAL 125	125	1997		F	
		M ALP 200 4T	200	2000	2003	F	
		M ALP 200 4T	200	2000	2003	R	
		M ALP 240	240	1996		F	
		M SUPERTRIAL 240	240	1992		F	
		M ALP 250	250	1997		F	
		M ALP 250	250	1997		R	
		M TECHNO 250	250	1996		F	
		M TECHNO 250	250	1996		R	
		M TR 35 250	250	1990	1991	F	
		M TR 35 250	250	1990	1991	R	
	BULTACO	M LOBITO 50	50	1998		R	
		M SHERPA 250	250	1999		F	
		M SHERPA 250	250	1999		R	
	CAGIVA	M CORSA 50	50	1998		F	
		M MANTIS 50	50	1998		F	
		M MITO 50	50	1998		R	
		M PROGRESS 50	50	1997		F	
	DERBI	M FDS 50	50	1986		F	
		M FENIX 50	50	1994		F	
		M GP1 50	50	2002	2006	F	
		M GP1 50 OPEN	50	2007		R	

M = MOTORCYCLE
S = SCOOTER
A = ATV
Sn = SNOWMOBILE



		CC	KW	FROM	TO	FRONT REAR	LEFT / RIGHT
	M GPR 50 R/REPLICA	50		1997	2005	R	
	M GPR 50 Race Replica	50		2008	2009	R	
	M HUNTER 50	50		1995		F	
	M PADDOCK 50 ST	50		1996		F	
	M PROGRESS 50	50		1997		F	
	M SENDA 50	50		1994		F	
	M SENDA DRD PRO 50	50		2005	2007	R	
	M SENDA DRD RACING R 50	50		2005		R	
	M SENDA DRS 50 Racing	50		2008		F	
	M SENDA DRS 50 Racing	50		2008		R	
	M SPORT EDITION 50	50		1995		F	
	M SUPER MOTARD 50	50		2001		F	
	M SUPER MOTARD 50	50		2001		R	
	M GPR 80 CUP Criterium Derbi Malossi	80		2008		R	
	M GPR 125 / NUDE (Radial Caliper)	125		2004	2009	R	
	M SENDA 125 R 4T	125		2005		R	
FANTIC	M TRIAL 50 .5	50		1989		F	
	M TRIAL 50 .5	50		1989		R	
	M TRIAL 50 .7	50		1990		F	
	M TRIAL 50 .7	50		1990		R	
	M TRIAL 50 .9	50		1991		F	
	M TRIAL 50 .9	50		1991		R	
	M TRIAL 125 .5	125		1989		F	
	M TRIAL 125 .5	125		1989		R	
	M TRIAL 125 .9	125		1991		F	
	M TRIAL 125 .9	125		1991		R	
	M TRIAL 249	249		1990		F	
	M TRIAL 249	249		1990		R	
	M COACH 250	250		1991		F	
	M K-ROO 250	250		1991		F	
	M K-ROO 250	250		1991		R	
	M TRIAL 305	305		1989		F	
	M TRIAL 305	305		1989		R	
	M TRIAL 307	307		1990	1991	F	
	M TRIAL 307	307		1990	1991	R	
GARELLI	M SAHEL 50	50		1991		R	
	M SAHEL 80	80		1989		R	
	M TRIAL 320	320		1986		F	
GASGAS	M PAMPERA 250	250		1996	2001	F	
	M PAMPERA 250	250		1996	2001	R	
	M TX 270	270			1998	F	
	M TX 270	270			1998	R	
GILERA	M GSM 50 / H @ K 50	50		2000	2003	F	
	M GSM 50 / H @ K 50	50		2000	2003	R	
	M RCR 50	50		2005		F	
	M RCR 50	50		2005		R	
	M SMT 50	50		2005		F	
	M SMT 50	50		2005		R	
HUSQVARNA	M WRS 50 (SCOOTER)	50		1998	2000	F	
ITALJET	M DRAGSTER 50	50		1998	2003	F	
	M DRAGSTER 50	50		1998	2003	R	
	M FORMULA 50	50		1997	2003	F	
	M FORMULA 50	50		1997	2003	R	
	M RG 50	50		1998		F	
	M TORPEDO 50	50		1997		F	
	M DRAGSTER 125	125		1999		F	
	M DRAGSTER 125	125		2000	2003	F	
	M DRAGSTER 125	125		2000	2003	R	
	M FORMULA 125	125		1997	2003	F	
	M FORMULA 125	125		1997	2003	R	
	M TORPEDO 125	125		1999	2003	F	
	M TWIN 125	125		1998	2000	F	
	M TWIN 125	125		1998	2000	R	
	M DRAGSTER 180	180		1999		F	
	M DRAGSTER 180	180		2000	2003	F	
	M DRAGSTER 180	180		2000	2003	R	
KTM	M SX 60	60		1998	1999	F	
	M SX 60 / 65	60		2000	2001	F	
MACAL	M TR 50 TROPHY H2O	50		1999		F	
MALAGUTI	M CR 1 50 CROSSER	50		1996		F	
	M DRAGON 50 NKD	50		2005		R	
	M XSM 50 SUPERMOTARD	50		2003		R	
	M XTM 50 / XSM 50	50		2003		F	
	M XTM 50 / XSM 50	50		2003		R	
	M X3M Motard 125	125		2008		R	
	M X3M Enduro 125	125		2008		F	
	M X3M Enduro 125	125		2008		R	
MONTESA	M EVASION 260	260		1994		F	
	M EVASION 260	260		1994		R	
	M COTA 310	310		1990		F	



		CC	KW	FROM	TO	FRONT REAR	LEFT / RIGHT
	M COTA 310	310		1990		R	
	M COTA 314 R	314		1994		F	
	M COTA 315 R	315		1998		F	
	M COTA 335	335		1987		F	
	M COTA 335	335		1987		R	
MONTESA (HONDA)	M MH 311 260	260		1992	1993	F	
	M MH 314 R	314		1994	1997	F	
	M MH 315 R	315		1997	2000	F	
MOTORHISPANIA	M MX 50 FURIA	50		2000		F	
	M MX 50 FURIA	50		2000		R	
	M RX 50 RACING	50		2000		R	
PEUGEOT	S Blaster Iceblade 50 (2T/12" Wheels)	50		2010	2012	F	
	S Blaster Iceblade 50 (2T/12" Wheels)	50		2010	2012	R	
	S Blaster RS 12 50 (2T)	50		2010	2011	F	
	S Blaster RS 12 50 (2T)	50		2010	2011	R	
	M ELYSEO 50	50		1998	2002	F	
	M ELYSEO 50	50		2003		F	
	M ELYSEO 50	50		2003		R	
	M JET FORCE 50	50		2003		F	
	M JET FORCE 50	50		2003		R	
	S Jet C Tech 50	50		2011	2012	F	
	S Jet C Tech 50	50		2011	2012	R	
	S Jet Darkside 50 (2T)	50		2011		F	
	S Jet Darkside 50 (2T)	50		2011		R	
	S Jet H2i 50 (2T -Air Cooled)	50		2011	2012	F	
	S Jet H2i 50 (2T-L/C)	50		2011	2012	F	
	S Jet H2i 50 (2T-L/C)	50		2011	2012	R	
	S Jet Iceblade 50 (2T)	50		2011		F	
	S Jet Iceblade 50 (2T)	50		2011		R	
	M LOOXOR 50	50		2001		F	
	S LooXoR 50 TSDI (Rear disc)	50		2006		F	
	S LooXoR 50 TSDI (Rear disc)	50		2006		R	
	S Ludix Blaster (10" Wheels)	50		2005	2009	F	
	S Ludix Acid	50		2006		F	
	S Ludix Red Zone	50		2006		F	
	S Ludix Urban Track	50		2006	2007	F	
	S Ludix 2 Trend 50cc (2T/12? wheels)	50		2007	2012	F	
	S Ludix Pro (4T / 14" Wheels/AJP Caliper)	50		2011		F	
	M SPEEDFIGHT 50 M (AJP caliper)	50		1997	1998	F	
	M SPEEDFIGHT 50 (liquid cooled AJP caliper)	50		1998	2000	F	
	M SPEEDFIGHT 50 (liquid cooled AJP caliper)	50		1998	2000	R	
	M SQUAB 50	50		1996	2001	F	
	S Streetzone 12 (50cc/2T)	50		2014		F	
	S TRK 50 (2T/10? Wheels)	50		2009	2012	F	
	S TRK 50 12 (2T/12? Wheels)	50		2009	2012	F	
	M VIVACITY 50 .	50		1998	2003	F	
	S Vivacity 2 50	50		2008	2011	F	
	M X FIGHT 50 M	50		2000		F	
	M X FIGHT 50 (liquid cooled)	50		2000		F	
	M X FIGHT 50 (liquid cooled)	50		2000		R	
	S XPS 50 Top Road (17? F/Wheel)	50		2010	2012	R	
	S XPS 50 Track (21? F/Wheel)	50		2011	2012	R	
	M XR 6 50	50		2002		R	
	M ZENITH 50	50		1996	2000	F	
	M ELYSEO 100	100		1998		F	
	M ELYSEO 100	100		1999	2002	F	
	M ELYSEO 100	100		2003		F	
	M ELYSEO 100	100		2003		R	
	M LOOXOR 100	100		2001		F	
	M LOOXOR 100	100		2001		R	
	M TREKKER 100	100		1998		F	
	M VIVACITY 100 .	100		1998		F	
	M X FIGHT 100 M	100		2000		F	
	M X FIGHT 100 (liquid cooled)	100		2000		F	
	M X FIGHT 100 (liquid cooled)	100		2000		R	
	M ELYSEO 125	125		1998	2000	F	
	M LOOXOR 125 / 150	125		2003		R	
	M LUDIX 125	125		2004		F	
	M SATELIS 125	125		2006		R	
	S XP 125 Street Evo 2	125		2005		R	
	S XPS 125 CT	125		2005	2007	F	
	S XPS 125 CT	125		2005	2007	R	
	M ELYSEO 150	150		2000		F	
	M XPS 6 SUPERMOTARD	600		2003		R	
RIEJU	M MRX 50 CASTROL	50		2001	2002	R	
	M MRX 50	50		2003	2008	F	
	M MRX 50	50		2003	2008	R	
	M MRX 50 PRO / TOP	50		2004	2008	R	
	M NKD 50	50		2007		R	
	M RR 50 THUNDERFIRE	50		1997	2002	F	

		CC	KW	FROM	TO	FRONT / REAR	LEFT / RIGHT
M	RR 50 THUNDERFIRE	50		1997	2002	R	
M	RR 50 CASTROL	50		2000	2002	R	
M	RR 50 SPORT	50		2003	2006	F	
M	RR 50 SPORT	50		2003	2006	R	
M	RS1 50	50		1997	2000	F	
M	RS1 50	50		1997	2000	R	
M	RS1 50	50		2001	2004	R	
M	RS2 MATRIX 50 (AJP)	50		2002	2008	R	
M	RS2 NKD	50		2005		R	
M	RS2 50 PRO (AJP)	50		2006	2008	F	
M	RS2 50 PRO (AJP)	50		2006	2008	R	
M	RS2 50	50		2009		R	
M	SMX 50	50		2002		F	
M	SMX 50	50		2002		R	
M	SMX 50 PRO	50		2004		R	
M	SPIKE 50	50		2004		F	
M	SPIKE 50	50		2004		R	
M	SPIKE 50 MOTARD	50		2004		R	
M	TANGO 50 / TANGOO! 50	50		2007		R	
M	TANGO 50 Motard	50		2009		R	
M	MRX 125	125		2002	2008	R	
M	NKD 125	125		2006	2007	R	
M	RS2 125 (AJP)	125		2006	2008	R	

		CC	KW	FROM	TO	FRONT / REAR	LEFT / RIGHT
M	RS2 125 / PRO	125		2009		R	
M	RS3 125	125		2009		R	
M	SMX 125	125		2002	2007	R	
M	SMX 125 / Street	125		2007		R	
M	TANGO 125 / PRO	125		2006	2010	R	
M	TANGO 250	250		2008	2011	R	
SIMSON	M SR 50 XC/XCE	50				F	
	M SR 50 /1 GAMMA	50		1994		F	
	M SR 50 GAMMA E	50		1994		F	
	M SR 80 XCE	80				F	
	M SR 80 /1 GAMMA	80		1994		F	
SUZUKI	M AY 50 WR KATANA	50		1998		F	
	M AY 50 W KATANA	50		1998		F	
	M DR 50 BIG	50		1989		F	
	M RMX 50	50		2000	2001	F	
	M RMX 50	50		2000	2001	R	
	M SMX 50 SUPER MOTARD	50		2000	2003	F	
	M SMX 50 SUPER MOTARD	50		2000	2003	R	
	M UF 50 ESTILETE	50		2000	2002	F	
	M UX 50 ZILLION	50		1998	2002	F	
YAMAHA	M DT 50 R	50		2002	2007	R	
	M TZR 50 /Race Replica 07	50		2004		R	
	M TY 250 R	250		1991	1993	F	

FRP408

70.0 x 51.0 x 8.3 mm

MATERIAL AVAILABILITY

AG	EF	P	PRP	ST	SM	SG	ZR	XRAC	ZRAC	CP1	CPRO
		✓	✓	✓				✓		⚠	✓

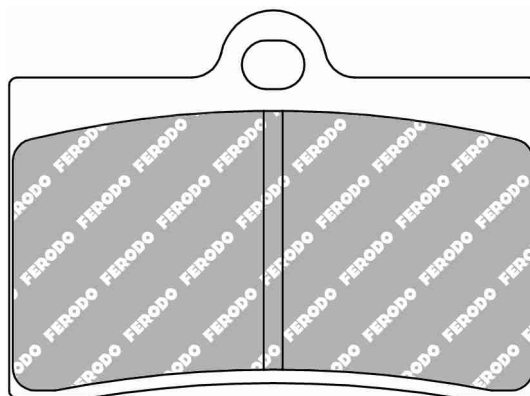

Pinze / Calipers

BREMBO

4-Piston; 8mm pad (P3034)

FD (Discacciati)

4-Piston

RevTech® / Custom Chrome

RevTech / CCI 4 Pot (CCI #18475)

WILWOOD

4-Piston (GP300/310)

CROSS REFERENCE

BRAKING	688
BREMBO	07BB15
BRENTA	3030
BRENTA	4030
CL BRAKES	2247
EBC	FA095
GALFER	FD068
GOLD FREN	064
LUCAS/TRW	MCB540
NEWFREN	FD0093
SBS	566
VESRAH	VD-945

M = MOTORCYCLE
S = SCOOTER
A = ATV
Sn = SNOWMOBILE



		CC	KW	FROM	TO	FRONT / REAR	LEFT / RIGHT
APRILIA	M RS 250	250		1995	1996	F	
	M RS 250	250		1997	1998	F	
ATK (USA)	M 500 Dirt Track	500		1998	1999	F	
	M 600 Dirt Track	600		1998	1999	F	
BETA	M JONATHAN 125	125		1999	2001	F	
	M JONATHAN 125	125		2002	2005	F	
	M EURO 350	350		1999	2001	F	
	M EURO 350	350		2002		F	
	M EURO / JONATHAN 350	350		2003	2006	F	
BIMOTA	M YB 7 400	400		1989		F	
	M V DUE 500	500		1997		F	
	M BELLARIA 600 SPORT	600		1991		F	
	M YB 9 600 SRI	600		1997		F	
	M SUPERMONO 650	650		1997		F	
	M SB 7 750	750		1996		F	
	M YB 4 750	750		1989		F	
	M TESI 851 1D	851		1991		F	
	M DB 1 - 2 900	900		1992		F	
	M MANTRA 900	900		1997		F	
	M DB 2 SR 904	904		1994	2000	F	
	M DB 4 904	904		1998	1999	F	
	M TESI 906 1D	906		1991		F	
	M YB 10 1000 BIPOSTO	1000		1992		F	
	M YB 11 1000	1000		1997		F	
	M YB 6 1000	1000		1989		F	
	M YB 8 1000 E.I. FURANO	1000		1990		F	
M YB 8 1000 E	1000		1990		F		
M YB 8 FURANO 1000	1000		1992		F		
M YB 10 DIECI 1002	1002		1991		F		
M SB 6 1100	1100		1997		F		
CAGIVA	M MITO 125	125		1993		F	
	M MITO 2 125 PRODUCTION RACER / Trofeo	125		1994		F	
	M MITO 525SP	125		2007		F	
	M PLANET 125	125		1998		F	
	M RAPTOR 125	125		2003		F	
	M RIVER 600	600		1994		F	
DUCATI	M 502 SINGLE	50		1993	1999	F	
	M 502 SUPERMONO	50		1993	1999	F	
	M 400 MONSTER	400		1995	1997	F	
	M SS 400 JUNIOR	400		1992		F	
	M SS 400 NUDA	400		1992		F	
	M 550 SUPERMONO	550		1993	1999	F	
	M 600 SUPERSPORT CARENATA	600		1994	1999	F	
	M 600 SUPERSPORT NUDA	600		1994	1999	F	
	M M 600 MONSTER	600		1993	1999	F	
	M 748 BIPOSTO	748		1995	1997	F	
	M 750 ENDURANCE	750		1987		F	
	M 750 LAGUNA SECA	750		1987		F	
	M 750 SUPERSPORT	750		1992	1997	F	
	M M 750 MONSTER	750		1996	1999	F	
	M SS 750 NUDA	750		1992	1998	F	
	M SS 750 CARENATA	750		1993	1998	F	
	M 851 all models	851		1988	1992	F	
	M 888 all models	888		1992	1995	F	
	M 900 all models	900		1992	1998	F	
	M 900 I.E. PASO	900		1992	1998	F	
M 900 SUPERMONO DESMO 4	900		1993	1995	F		
M M 900 MONSTER	900		1993	1999	F		
M 916 STRADA / SENNA / SP / SPS	916		1994	1997	F		



		CC	KW	FROM	TO	FRONT / REAR	LEFT / RIGHT	
GASGAS	M FSE 450 SM	450		2003		F		
GILERA	M SATURNO 500 PIUMA	500		1990		F		
HONDA	M TSR 250	250		1999		F		
HUSABERG	M FE 600 SUPERMOTARD	600		2000	2007	F		
HUSQVARNA	M SM 450 R	450		2003	2006	F		
	M SM 510 R	510		2005	2005	F		
	M SM 570 R	570			2004	F		
	M SMR 630	630			2006	F		
INDIAN	M Bomber (Brembo Calipers)			2010	2011	F		
	M Chief Blackhawk (Brembo calipers)				2011	F		
	M Chief Blackhawk Dark (Brembo calipers)				2011	F		
	M Chief Deluxe (Brembo calipers)				2009	F		
	M Chief Standard (Brembo calipers)				2009	2011	F	
	M Chief Roadmaster (Brembo calipers)				2009	2011	F	
	M Chief Vintage (Brembo calipers)				2009	2013	F	
	M Chief Classic (Brembo calipers)			2011	2013	F		
	M Dark Horse (Brembo calipers)			2010	2013	F		
ITALJET	M GRIFON 900	900		2001		F		
KTM	M LC2 STING 125	125		1998		F		
	M THE DUKE 400	400		1994	1998	F		
	M THE DUKE 620	620		1994	1998	F		
LAVERDA	M 650 (all models)	650		1995	1996	F		
	M LYNX 650	650		2000		F		
	M GHOST - DIAMANTE 668	668		1997	1998	F		
	M CUP 750	750		1998		F		
	M DIAMANTE 750	750		1997		F		
	M 750 S (all models)	750		1999		F		
	M TTS 800	800		1999		F		
	M JOTA 1000	1000		1995		F		
MOTO GUZZI	M CENTAURO 1000	1000		1996	1999	F		
	M DAYTONA 1000	1000		1991	1994	F		
	M DAYTONA 1000	1000		1995	1998	F		
	M CALIFORNIA 1100 EV	1100		1997	2000	F		
	M CALIFORNIA 1100	1100		1997	2001	F		
	M CENTAURO 1100 V11 SPORT	1100		1999	2000	F		
	M SPORT 1100	1100		1994	1999	F		
MZ	M SKORPION REPLICHA	660		1995		F		
NORTON	M FORMULA 1	588		1989	1991	F		
	M FORMULA 1 SPORT	588		1992		F		
	M FORMULA 1 SPORT	588		1992		R		
TM	M SMR 125 (2T)	125		2005	2014	F		
	M SM 250	250		2002		F		
	M SME 250 (4T)	250		2004		F		
	M SMM 250 (2T)	250		2005	2014	F		
	M SMR 250 (2T)	250		2005	2014	F		
	M SMM 300 (2T)	300		2005	2014	F		
	M SMR 300 (2T)	300		2005	2014	F		
	M SM 400	400		2002	2003	F		
	M SME 400 (4T)	400		2004		F		
	M SMR 450 FES	450		2005	2009	F		
	M 530 (4T) Cross	530		2002	2003	F		
	M SM 530	530		2002	2003	F		
	M SME 530 (4T)	530		2004		F		
M SMR 530 F ES	530		2005	2009	F			
	M SMX 660 F	660		2004		F		
YAMAHA	M TZR 125 (Italia)	125		1991		F		
	M TZR 125 RED ROCKET	125		1993		F		
	M TZR 250 R	250		1994		F		
	M SZR 660	660		1996	1997	F		

FRP410

84.0 x 54.0 x 8.0 mm

MATERIAL AVAILABILITY											
AG	EF	P	PRP	ST	SM	SG	ZR	XRAC	ZRAC	CP1	CPRO
		✓									

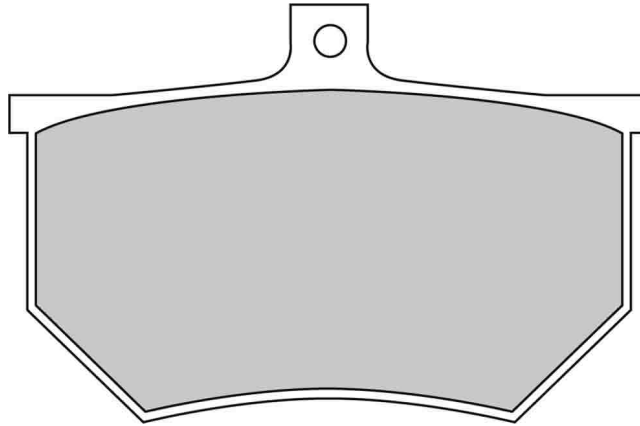

Pinze / Calipers

AP RACING

CP2044 (4 Piston) early w/ tabs
 CP3086 (4 Piston) radial narrow-band
 CP4485 (4 Piston)

Lockheed

4-Piston, 8mm

Spondon

Spondon 4 Piston (w/ lugs removed)

CROSS REFERENCE

EBC	FA107A
NEWFREN	FD0118
SBS	661

FRP415

33.6 x 49.7 x 7.0 mm

MATERIAL AVAILABILITY											
AG	EF	P	PRP	ST	SM	SG	ZR	XRAC	ZRAC	CP1	CPRO
		✓									

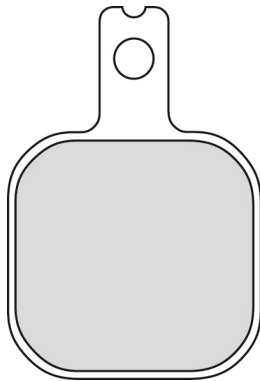

Pinze / Calipers

FLORIDA Caliper

6-Piston (Harrison)

HARRISON Billet

4 Piston new style
 6 Piston new style
 MINI 6 (6-Piston) **

ISR

6-Piston, Large **

CROSS REFERENCE

EBC	FA175
GALFER	FD160
LUCAS/TRW	MCB633

FRP416

40.0 x 56.6 x 9.3 mm

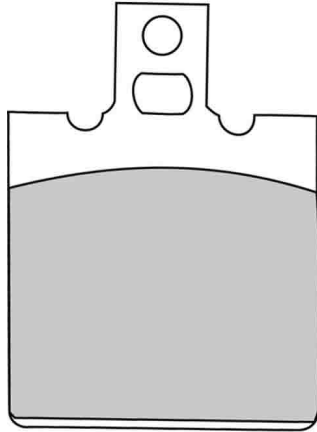

MATERIAL AVAILABILITY											
AG	EF	P	PRP	ST	SM	SG	ZR	XRAC	ZRAC	CP1	CPRO
		✓									

Pinze / Calipers

ISR

2-Piston (22-027)

4-Piston (22-025) *

CROSS REFERENCE	
BREMBO	07HO33
BREMBO	107268641
EBC	FA047/3
GALFER	FD190
LUCAS/TRW	MCB623
NEWFREN	FD0160
SBS	646
VESRAH	VD-911/2

		CC	KW	FROM	TO	FRONT / REAR	LEFT / RIGHT
 HONDA	M CRM 125 (Italy)	125		1990	1999	R	
	M NSR 125 FII	125		1991	1993	R	
	M NSR 125 R	125		1991	2001	R	

		CC	KW	FROM	TO	FRONT / REAR	LEFT / RIGHT
 HONDA-HM ITALIA	M NSR 125 F RAIDEN	125		1994	1996	R	
	M NSR 125 R	125		1989		R	
	M MARATHON 450 Motard	450		2010		F	

FDB88

44.5 x 55.5 x 9.4 mm



MATERIAL AVAILABILITY											
AG	EF	P	PRP	ST	SM	SG	ZR	XRAC	ZRAC	CP1	CPRO
		✓									

CROSS REFERENCE	
EBC	FA027
LUCAS/TRW	MCB18
SBS	505
VESRAH	VD-904

4006



		CC	KW	FROM	TO	FRONT / REAR	LEFT / RIGHT
	M K 100 1000 RS 16 VALVES	1000		1990	1992	R	
	M K 100 1000 RT	1000		1983	1988	F	
	M K 100 1000 RT	1000		1983	1988	R	
	M K 100 1000 RT	1000		1988	1989	F	
	M K 100 1000 RT	1000		1988	1989	R	
	M R 100 1000 RS - RT - CS	1000		1981	1988	F	
	M R 100 1000 RS - RT - CS	1000		1981	1988	R	
	M R 100 1000 all models	1000		1981	1989	F	
	M R 100 1000 all models	1000		1981	1989	R	
	M R 100 1000 RT	1000		1991	1995	F	
	M R 1100 RS (ABS)	1100		1994	2001	R	
	M K 1200 GT	1200		2003	2007	R	
	M K 1200 RS	1200		1997	2001	R	
	M K 1200 RS	1200		2002		R	
DUCATI	M 650 DESMO	650		1987		F	
	M 750 SUPERSPORT	750		1976	1991	F	
	M 750 SUPERSPORT	750		1976	1991	R	
	M 750 F1 DESMO	750		1986		F	
	M 750 ENDURANCE	750		1987		R	
	M 750 LAGUNA SECA	750		1987		R	
	M 750 PASO	750		1987		F	
	M 750 PASO	750		1987		R	
	M 750 SPORT	750		1989	2000	F	
	M 750 SPORT	750		1989	2000	R	
	M 860 GT	860		1974	1976	F	
	M 860 GT	860		1974	1976	R	
	M 860 GTS	860	65	1975	1976	F	
	M 860 GTS	860	65	1975	1976	R	
	M 906 PASO	906		1989	1990	F	
	M 906 PASO	906		1989	1990	R	
	M 1000 all models	1000		1984		F	
	M 1000 all models	1000		1984		R	
INDIAN	M Bomber (Brembo Calipers)			2010	2011	R	
	M Chief Blackhawk (Brembo calipers)				2011	R	
	M Chief Blackhawk Dark (Brembo calipers)				2011	R	
	M Chief Deluxe (Brembo calipers)				2009	R	
	M Chief Standard (Brembo calipers)			2009	2011	R	
	M Chief Roadmaster (Brembo calipers)			2009	2011	R	
	M Chief Vintage (Brembo calipers)			2009	2013	R	
	M Chief Classic (Brembo calipers)			2011	2013	R	
	M Dark Horse (Brembo calipers)			2010	2013	R	
LAVERDA	M SFC 500	500		1977		F	
	M SFC 500	500		1977		R	
	M SFC 1000	1000		1986		F	



		CC	KW	FROM	TO	FRONT / REAR	LEFT / RIGHT
	M SFC 1000	1000		1986		R	
MOTO GUZZI	M NTX 350	350		1990		R	
	M V 35 350 GT	350		1990		F	
	M NTX 650	650		1990		R	
	M V 65 650 GT	650		1990		F	
	M NTX 750	750		1990		R	
	M S 750	750		1974	1975	F	
	M S3 750	750		1975	1976	F	
	M S3 750	750		1975	1976	R	
	M CALIFORNIA 850 T3	850		1975	1980	F	
	M CALIFORNIA 850 T3	850		1975	1980	R	
	M T5 850	850		1984		F	
	M T5 850	850		1984		R	
	M CALIFORNIA 1000 II	1000		1981	1987	F	
	M CALIFORNIA 1000 II	1000		1981	1987	R	
	M CALIFORNIA 1000 III	1000		1988	1993	F	
	M CALIFORNIA 1000 III	1000		1988	1993	R	
	M DAYTONA 1000	1000		1991	1994	R	
	M DAYTONA 1000	1000		1995	1998	R	
	M GT V 1000	1000		1991		F	
	M GT V 1000	1000		1991		R	
	M LE MANS 1000	1000		1984	1993	F	
	M LE MANS 1000	1000		1984	1993	R	
	M LE MANS - V 1000	1000		1990		F	
	M LE MANS - V 1000	1000		1990		R	
	M SP 1000	1000		1978	1983	F	
	M SP 1000 II	1000		1984		F	
	M SP 1000 II	1000		1984		R	
	M SP III 1000	1000		1991		F	
	M SP III 1000	1000		1991		R	
	M CALIFORNIA 1100	1100		1994	1997	F	
	M CALIFORNIA 1100	1100		1994	1997	R	
MZ	M ETZ 125	125		1982	1992	F	
	M SAXON 125	125		1993	1997	F	
	M ETZ 150	150		1982	1992	F	
	M SAXON 150	150		1995		F	
	M FUN 251	251		1995	1996	F	
	M ETZ 301	301		1990	1992	F	
	M SAXON 500	500		1993	1998	F	
NORTON	M INTERPOL 2 (ROTARY)	588		1983		F	
	M INTERPOL 2 (ROTARY)	588		1983		R	
SWM	M XP 350 SAHARA	350		1983		F	
ZUNDAPP	M KS 125	125		1982		F	
	M KS 175	175		1982		F	

FDB119

51.9 x 51.9 x 12.8 mm / 51.9 x 51.9 x 19.7 mm

MATERIAL AVAILABILITY											
AG	EF	P	PRP	ST	SM	SG	ZR	XRAC	ZRAC	CP1	CPRO
		✓									

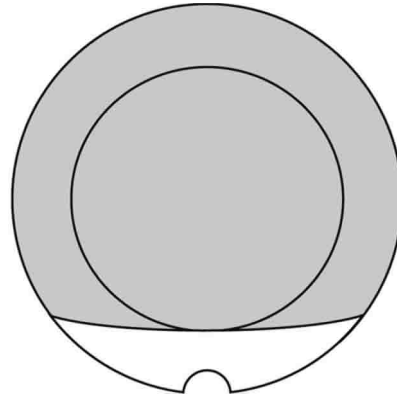
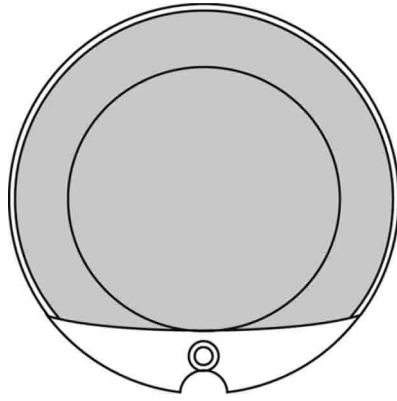

CROSS REFERENCE	
BREMBO	07HO01
EBC	FA013
GALFER	FD005
LUCAS/TRW	MCB35
NEWFREN	FD0005
SBS	501
VESRAH	VD-102
VESRAH	VD-106

		CC	KW	FROM	TO	FRONT REAR	LEFT RIGHT
	HONDA						
	M	CB 250 G5	250	1974	1976	F	
	M	CJ 250 I	250	1977		F	
	M	CJ 360 T all models	360	1978		F	
	M	CB 400 F - F1 - F2	400	1975	1979	F	
M	CB 500 K1 - K2 - T	500	1975	1977	F		

		CC	KW	FROM	TO	FRONT REAR	LEFT RIGHT
	M	CB 550 F - F1 - F2	550	1978		F	
	M	CB 550 K3	550	1978		F	
	M	CB 750 F - F1	750	1976	1978	F	
	M	CB 750 K7 - K8	750	1978		F	

FDB132

52.0 x 54.0 x 12.3 mm / 50.0 x 41.0 x 12.3 mm

MATERIAL AVAILABILITY

AG	EF	P	PRP	ST	SM	SG	ZR	XRAC	ZRAC	CP1	CPRO
		✓									

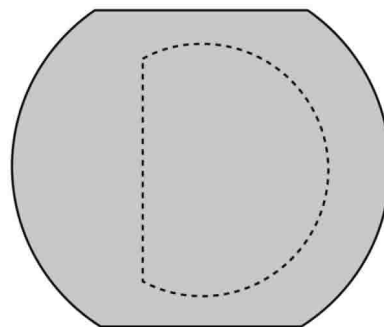
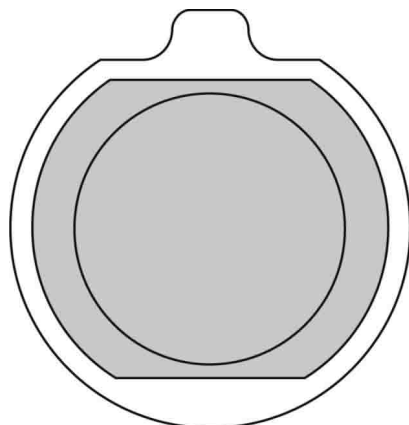

CROSS REFERENCE

BREMBO	07KA01
EBC	FA033
EBC	FA073
GALFER	FD014
LUCAS/TRW	MCB79
NEWFREN	FD0014
SBS	510
VESRAH	VD-404
VESRAH	VD-408
VESRAH	VD-409
VESRAH	VD-411
VESRAH	VD-414
VESRAH	VD-417



		CC	KW	FROM	TO	FRONT / REAR	LEFT / RIGHT
KAWASAKI	M KH 250 B1 - S	250		1977	1982	F	
	M Z 250 A1 - A2	250		1978	1980	F	
	M KH 400 A3-5	400		1976	1981	F	
	M Z 400 G1	400		1979		F	
	M Z 400 J1 LTD	400		1980	1981	F	
	M Z 440 A2 - C1	440		1979	1982	F	
	M Z 440 D2 - D4 LTD	440		1979	1982	F	
	M KH 500 A8	500		1976		F	
	M Z 500 A1 - A3	500		1979	1980	F	
	M Z 500 B1 - B3	500		1979	1980	F	
	M A1 550 LTD	550		1980		F	
	M Z 550 A1	550		1980		F	
	M Z 650 B1 - B3	650		1979	1981	F	



		CC	KW	FROM	TO	FRONT / REAR	LEFT / RIGHT
	M Z 650 C1 - C2 - C3	650		1976	1977	F	
	M Z 650 D2 - D3	650		1978	1981	F	
	M Z 650 F1	650		1979	1980	F	
	M Z 650 SR	650		1978	1981	F	
	M Z 750 B1 - B2	750		1977	1978	F	
	M Z 750 B1 - B2	750		1977	1978	R	
	M Z 750 D1	750		1976	1978	F	
	M Z 750 D1	750		1976	1978	R	
	M KZ 900 B1	900		1976	1977	F	
	M Z 900 A 4	900		1977	1978	F	
	M KZ 1000 B1/B2 LTD	1000		1977	1978	F	
	M Z 1000 A1 - A4 - H1 - H2	1000		1974	1978	F	

FDB134

58.0 x 63.0 x 10.4 mm

MATERIAL AVAILABILITY											
AG	EF	P	PRP	ST	SM	SG	ZR	XRAC	ZRAC	CP1	CPRO
		✓									

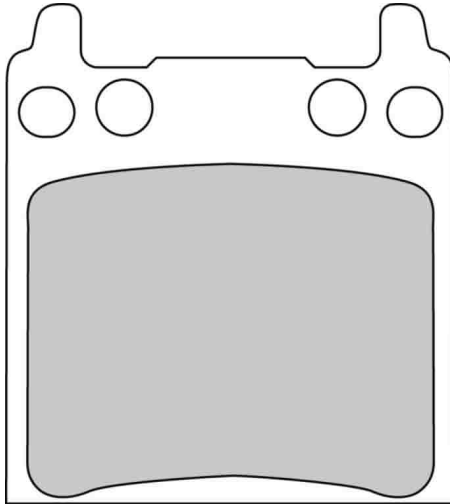

Pinze / Calipers

Performance Machine

162x2 2-Piston

CROSS REFERENCE

BREMBO	07HO04
EBC	FA032
GALFER	FD025
LUCAS/TRW	MCB63
NEWFREN	FD0025
SBS	509
VESRAH	VD-108
VESRAH	VD-116

		CC	KW	FROM	TO	FRONT		LEFT	
						REAR	RIGHT	REAR	RIGHT
 HONDA	M	CB 750 F - F1	750		1976	1978	R		
	M	GL 1000 K1 - 2 - 3	1000		1977	1979	R		

		CC	KW	FROM	TO	FRONT		LEFT	
						REAR	RIGHT	REAR	RIGHT
 M	GL 1000 KZ	1000		1977	1979	R			

FDB148

56.0 x 55.0 x 7.6 mm

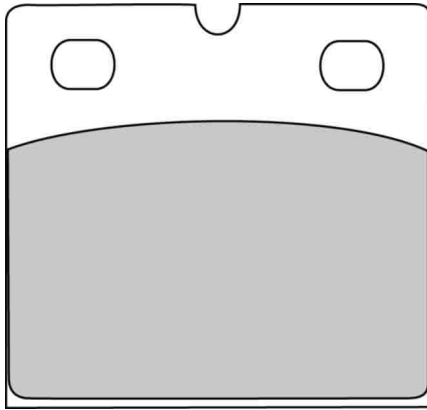

MATERIAL AVAILABILITY											
AG	EF	P	PRP	ST	SM	SG	ZR	XRAC	ZRAC	CP1	CPRO
		✓		✓							

ALSO AVAILABLE

SHAPE	TH. MM	NOTES
FDB108	9.0	

Pinze / Calipers



BREMBO

2-Piston (F08/P108)

CROSS REFERENCE

BREMBO	07BB14
CL BRAKES	2332
EBC	FA018
GALFER	FD013
NEWFREN	FD0189
SBS	506

		CC	KW	FROM	TO	FRONT REAR	LEFT RIGHT
	DUCATI	M 250 DESMO	250		1977	F	
		M 350 DESMO	350		1977	F	
		M 600 SL	600	1976		F	
		M 600 SL	600	1976		R	
		M 600 TL PANTAH	600	1976		F	
		M 600 TL PANTAH	600	1976		R	
	LAVERDA	M SF3 750	750	1977		F	
		M SF3 750	750	1977		R	
		M RGA 1000	1000			F	
		M RGA 1000	1000			R	
		M RGA 1000 JOTA	1000			F	
		M RGA 1000 JOTA	1000			R	
		M RGS 1000 EXECUTIVE	1000			F	
		M RGS 1000 EXECUTIVE	1000			R	
		M RGS 1000 CORSA	1000			F	
		M RGS 1000 CORSA	1000			R	
	M RGS 1000 JOTA	1000	1977		F		

		CC	KW	FROM	TO	FRONT REAR	LEFT RIGHT
	MOTO GUZZI	M RGS 1000 JOTA	1000	1977		R	
		M T.T. 1200	1200	1976		F	
		M T.T. 1200	1200	1976		R	
		M LE MANS 850	850	1976		F	
		M LE MANS 850	850	1976		R	
		M T 850	850	1974	1975	F	
		M T3 850	850	1975	1979	F	
		M T3 850	850	1975	1979	R	
		M T4 850	850	1980	1983	F	
		M T4 850	850	1980	1983	R	
	MZ	M V 1000 1000 I CONVERT	1000	1975		F	
		M V 1000 1000 I CONVERT	1000	1975		R	
		M V 1000 1000 G5	1000	1978		F	
		M V 1000 1000 G5	1000	1978		R	
	TRIUMPH	M ETZ 250	250	1982	1992	F	
		M BONNEVILLE 750 TWIN (Brembo calipers)	750	1985	1986	F	
	M BONNEVILLE 750 TWIN (Brembo calipers)	750	1985	1986	R		

FDB150

50.0 x 53.0 x 12.4 mm / 50.0 x 50.0 x 10.5 mm

MATERIAL AVAILABILITY											
AG	EF	P	PRP	ST	SM	SG	ZR	XRAC	ZRAC	CP1	CPRO
		✓									

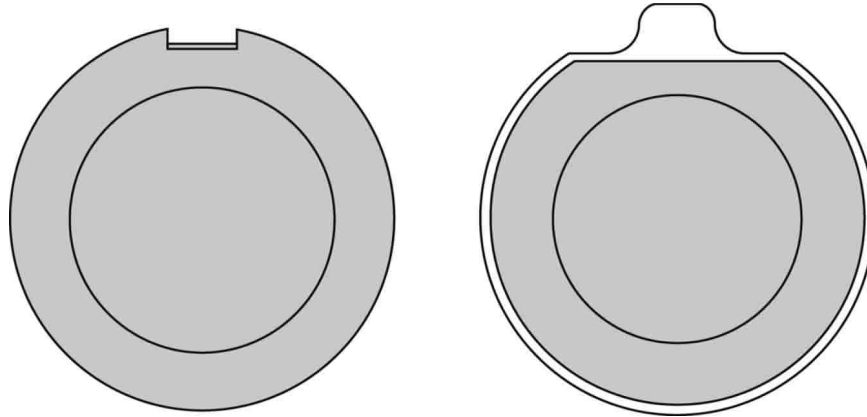

CROSS REFERENCE	
BREMBO	07SU01
EBC	FA035
GALFER	FD035
LUCAS/TRW	MCB70
NEWFREN	FD0035
SBS	511
VESRAH	VD-305
VESRAH	VD-318

		CC	KW	FROM	TO	FRONT / REAR	LEFT / RIGHT
 SUZUKI	M	GS 400 B - C	400	1977	1978	F	
	M	GS 425 EN	425	1978	1980	F	
	M	GS 750 B	750	1976	1976	F	
	M	GS 750 DB	750	1977	1980	F	

		CC	KW	FROM	TO	FRONT / REAR	LEFT / RIGHT
 SUZUKI	M	GS 750 DL	750	1977	1980	F	
	M	GS 750 EC	750	1977	1980	F	
	M	GS 750 EN	750	1977	1980	F	

M = MOTORCYCLE
S = SCOOTER
A = ATV
Sn = SNOWMOBILE

FDB151

58.0 x 53.0 x 9.0 mm

MATERIAL AVAILABILITY											
AG	EF	P	PRP	ST	SM	SG	ZR	XRAC	ZRAC	CP1	CPRO
		✓	✓	✓							

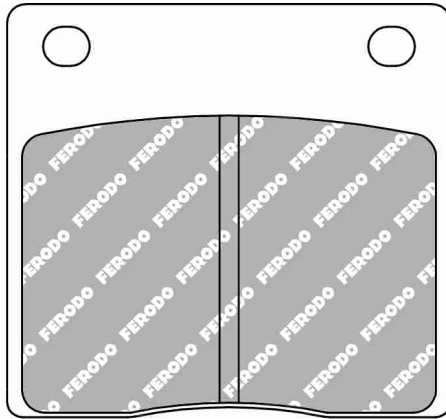



Pinze / Calipers

GMA

A Series (2-Piston)

CROSS REFERENCE	
BRAKING	622
BREMBO	07KS02
CL BRAKES	2280
EBC	FA036
LUCAS/TRW	MCB73
NEWFREN	FD0022
SBS	512
VESRAH	VD-306
VESRAH	VD-306/2

		CC	KW	FROM	TO	FRONT / RÉAR	LEFT / RIGHT
 KAWASAKI	M Z 500 A1 - A3	500		1979	1980	R	
	M Z 500 B1 - B3	500		1979	1980	R	
	M Z 1000 A1 - A4 - H1 - H2	1000		1974	1978	R	
	M Z 1000 E1 - E2 - SHAFT - ST	1000		1979	1981	R	
	M Z 1300	1300		1979	1983	R	
M ZG 1300 DF1	1300		1984	1986	R		

		CC	KW	FROM	TO	FRONT / RÉAR	LEFT / RIGHT
 SUZUKI	M GS 850 GN - GT - GX	850		1979	1981	R	
	M GS 850 GZ - GE - GG	850		1982	1985	R	
	M GS 1000 EC - EN - HC - SN	1000		1978	1979	R	
	M GS 1000 ET	1000		1980	1981	R	
	M GSX 1000 S KATANA	1000		1982		R	
	M GV 1200 GL MADURA	1200		1985	1986	R	

FDB155

71.6 x 34.0 x 13.5 mm

Minimum thickness 8 mm

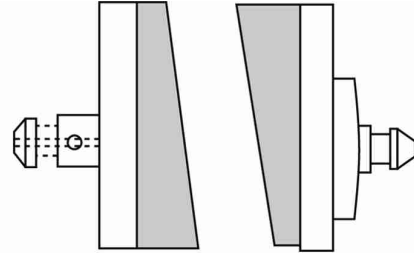
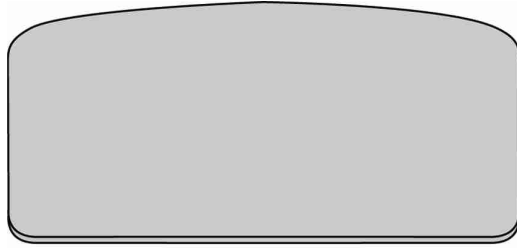

MATERIAL AVAILABILITY											
AG	EF	P	PRP	ST	SM	SG	ZR	XRAC	ZRAC	CP1	CPRO
		✓									

CROSS REFERENCE	
BREMBO	07GR59
EBC	FA022
GALFER	FD036
LUCAS/TRW	MCB17
NEWFREN	FD0036
SBS	520
VESRAH	VD-910

		CC	KW	FROM	TO	FRONT / REAR	LEFT / RIGHT
 BMW	M R 60/7 600	600		1976	1978	F	
	M R 75/6 750	750		1975	1979	F	
	M R 80 800 all models	800		1977	1981	F	

		CC	KW	FROM	TO	FRONT / REAR	LEFT / RIGHT
 	M R 90 900 S	900		1973	1976	F	
	M R 90/6 900	900		1973	1976	F	
	M R 100 1000 all models	1000			1981	F	

FDB177

67.5 x 49.8 x 11.0 mm

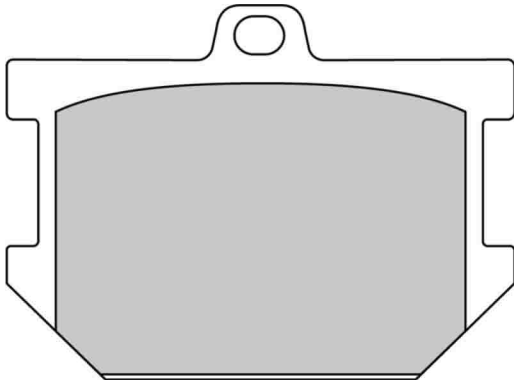

MATERIAL AVAILABILITY											
AG	EF	P	PRP	ST	SM	SG	ZR	XRAC	ZRAC	CP1	CPRO
		✓									

CROSS REFERENCE	
BREMBO	07YA03
CL BRAKES	2847
EBC	FA034
GALFER	FD017
LUCAS/TRW	MCB68
NEWFREN	FD0017
SBS	507
VESRAH	VD-205

M = MOTORCYCLE
S = SCOOTER
A = ATV
Sn = SNOWMOBILE

		CC	KW	FROM	TO	FRONT / REAR	LEFT / RIGHT
 YAMAHA	M XS 250	250		1978	1978	F	
	M XS 250	250		1978	1978	R	
	M XS 250 D - E	250		1979	1981	F	
	M XS 360 C	360		1976		F	
	M XS 360 C	360		1976		R	
	M SR 400	400		1977	1984	F	
	M SR 400	400		1977	1984	R	
	M XS 400	400		1979	1979	F	
	M SR 500	500		1978	1982	F	
	M XS 500 C	500		1976	1979	F	
	M XS 500 C	500		1976	1979	R	
	M KJ 650	650		1980		F	
	M XS 650	650		1977	1981	F	

		CC	KW	FROM	TO	FRONT / REAR	LEFT / RIGHT
	M XS 650 SE	650		1979	1980	F	
	M XS 650 SE	650		1979	1980	R	
	M XS 650 SE	650		1981		F	
	M XS 750	750		1977	1979	F	
	M XS 750	750		1977	1979	R	
	M XS 750 SE - SG	750		1979	1980	R	
	M XS 850	850			1980	F	
	M XS 850	850			1980	R	
	M XS 850	850		1980	1982	R	
	M XV 1000 TR 1	1000		1981		F	
	M XS 1100	1100		1978	1980	F	
	M XS 1100	1100		1978	1980	R	
	M XS 1100 S	1100		1981		R	

FDB178

50.0 x 53.4 x 12.2 mm / 50.0 x 53.5 x 11.7 mm

MATERIAL AVAILABILITY											
AG	EF	P	PRP	ST	SM	SG	ZR	XRAC	ZRAC	CP1	CPRO
		✓									

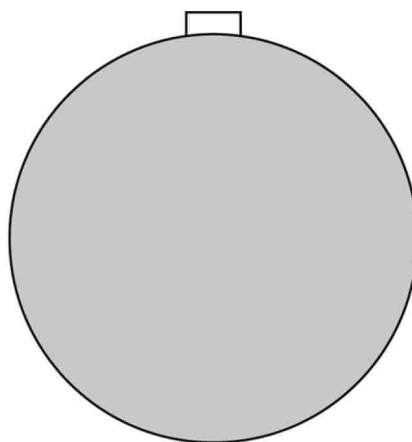
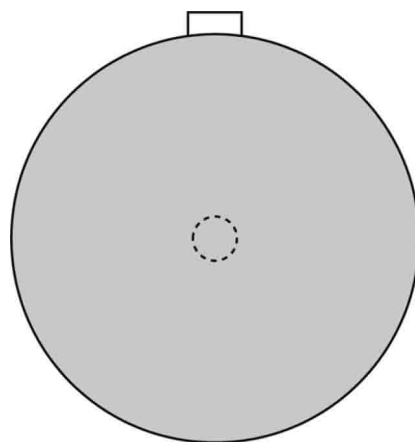

CROSS REFERENCE	
BREMBO	07SU02
EBC	FA038
GALFER	FD038
LUCAS/TRW	MCB72
NEWFREN	FD0038
SBS	515
VESRAH	VD-320

		CC	KW	FROM	TO	FRONT / REAR	LEFT / RIGHT
 SUZUKI	M GT 200 EN - EX	200		1979	1982	F	
	M GT 200 X 5	200		1979	1982	F	
	M GT 250 EN - ET - EX	250		1978		F	
	M GT 250 X7	250		1978		F	
	M GS 500 EK - EL	500		1981	1988	F	

		CC	KW	FROM	TO	FRONT / REAR	LEFT / RIGHT
	M RE 500 5 A - M	500		1975	1977	F	
	M GS 550 B - C - D	550		1977	1978	F	
	M GS 550 EC - EN	550		1978	1979	F	
	M GS 850 GN - GT - GX	850		1979	1981	F	
	M GS 1000 EC - EN - HC - SN	1000		1978	1979	F	

FDB182

67.5 x 49.4 x 9.5 mm

MATERIAL AVAILABILITY											
AG	EF	P	PRP	ST	SM	SG	ZR	XRAC	ZRAC	CP1	CPRO
		✓									

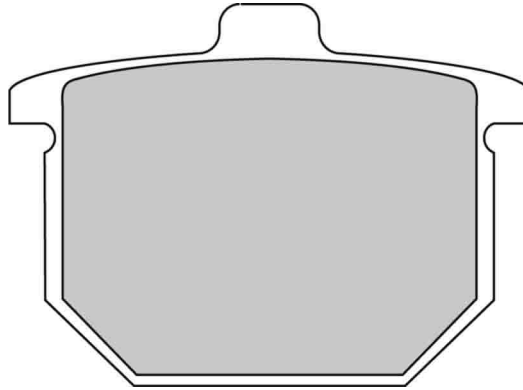

CROSS REFERENCE	
BREMBO	07HO03
CL BRAKES	2814
EBC	FA030
GALFER	FD016
LUCAS/TRW	MCB54
NEWFREN	FD0016
SBS	508
SBS	517
VESRAH	VD-112
VESRAH	VD-112/2
VESRAH	VD-112/3

		CC	KW	FROM	TO	FRONT / REAR	LEFT / RIGHT
	HONDA						
	M	CB 400 N - NA - NB	400	1978	1982	F	
	M	CM 400 AA	400	1978	1981	F	
	M	CM 400 AB-TA	400	1978	1981	F	
	M	CM 400 A	400	1978	1981	F	
	M	CM 400 TZ	400	1978		F	
	M	CM 400 T	400	1978	1981	F	
	M	CM 400 TC	400	1978	1981	F	
	M	CM 400 TB	400	1978		F	
	M	CX 500 CA - CB	500	1979	1981	F	
	M	CB 750 F2 - F3	750	1977		F	
	M	CB 750 F2 - F3	750	1977		R	
	M	CB 750 FZ	750	1979		F	

		CC	KW	FROM	TO	FRONT / REAR	LEFT / RIGHT
							
	M	CB 750 FZ	750	1979		R	
	M	CB 750 FA - FB - F2C	750	1980		F	
	M	CB 900 F - FZ - FA	900	1979	1981	F	
	M	CB 900 F - FZ - FA	900	1979	1981	R	
	M	CBX 1000	1000	1977	1980	F	
	M	CBX 1000	1000	1977	1980	R	
	M	GL 1000	1000	1981		F	
	M	GL 1000	1000	1981		R	
	M	GL 1000 K1 - 2 - 3	1000	1977	1979	F	
	M	GL 1000 KZ	1000	1977	1979	F	
	M	GL 1100	1100	1980	1981	F	
	M	GL 1100	1100	1980	1981	R	

M = MOTORCYCLE
S = SCOOTER
A = ATV
Sn = SNOWMOBILE

FDB183

52.7 x 53.1 x 9.7 mm

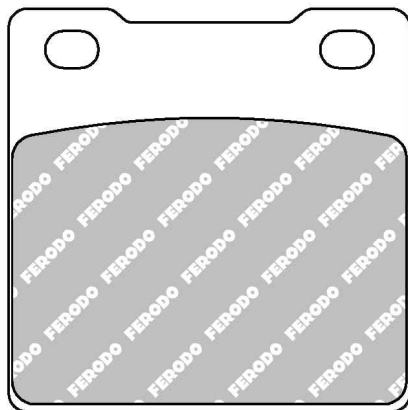

MATERIAL AVAILABILITY											
AG	EF	P	PRP	ST	SM	SG	ZR	XRAC	ZRAC	CP1	CPRO
		✓									

CROSS REFERENCE	
BRAKING	645
BREMBO	07HO07
CL BRAKES	2282
EBC	FA045
GALFER	FD045
LUCAS/TRW	MCB55
NEWFREN	FD0045
SBS	526
VESRAH	VD-117

		CC	KW	FROM	TO	FRONT / REAR	LEFT / RIGHT
 HONDA	M CB 250 T	250		1978	1982	F	
	M CB 250 N	250		1978	1982	F	
	M CB 250 RS	250		1981	1984	F	
	M CM 250 TB	250		1981		F	
	M CB 400 A - HAWK	400		1978		F	

		CC	KW	FROM	TO	FRONT / REAR	LEFT / RIGHT
 	M CB 450 N	450		1985		F	
	M CB 650 A - Z	650		1979	1981	F	
	M CB 650 B	650		1979	1981	F	
	M CB 750 KZ	750		1980		F	

FDB184

95.0 x 57.1 x 12.0 mm

Minimum thickness 7,5 mm

MATERIAL AVAILABILITY											
AG	EF	P	PRP	ST	SM	SG	ZR	XRAC	ZRAC	CP1	CPRO
		✓									

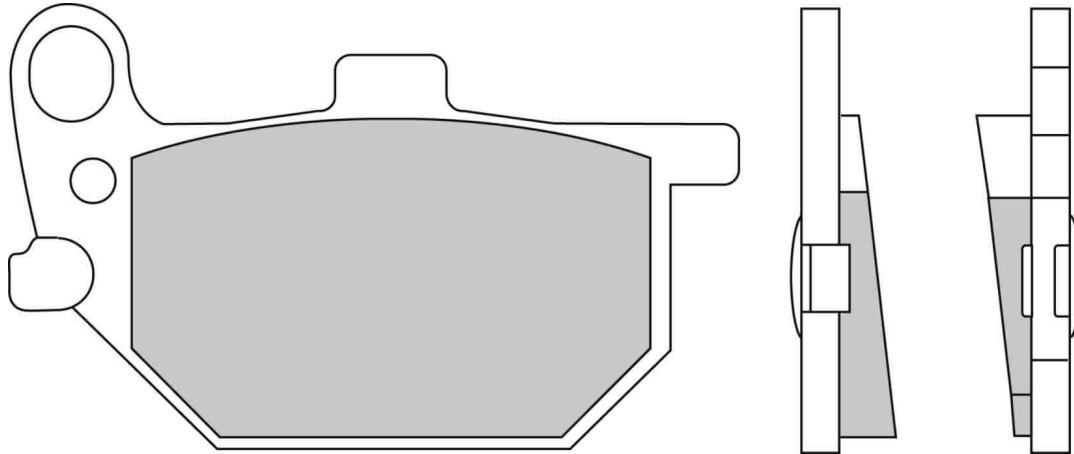

CROSS REFERENCE	
BREMBO	07YA07
EBC	FA041
GALFER	FD067
LUCAS/TRW	MCB503
NEWFREN	FD0065
SBS	528
VESRAH	VD-215

		CC	KW	FROM	TO	FRONT / RÉAR	LEFT / RIGHT
 YAMAHA	M RD 250 E - F	250		1978	1979	F	
	M RD 250 E - F	250		1978	1979	R	
	M XS 250 SE - SF SPECIAL	250		1979	1981	F	
	M RD 400 E - F	400		1978		F	

		CC	KW	FROM	TO	FRONT / RÉAR	LEFT / RIGHT
 	M RD 400 E - F	400		1978		R	
	M XS 400 SE	400		1980	1981	F	
	M XS 850	850		1980	1982	F	right

M = MOTORCYCLE
S = SCOOTER
A = ATV
Sn = SNOWMOBILE

FDB185

114.0 x 65.2 x 7.4 mm

MATERIAL AVAILABILITY											
AG	EF	P	PRP	ST	SM	SG	ZR	XRAC	ZRAC	CP1	CPRO
		✓	✓								

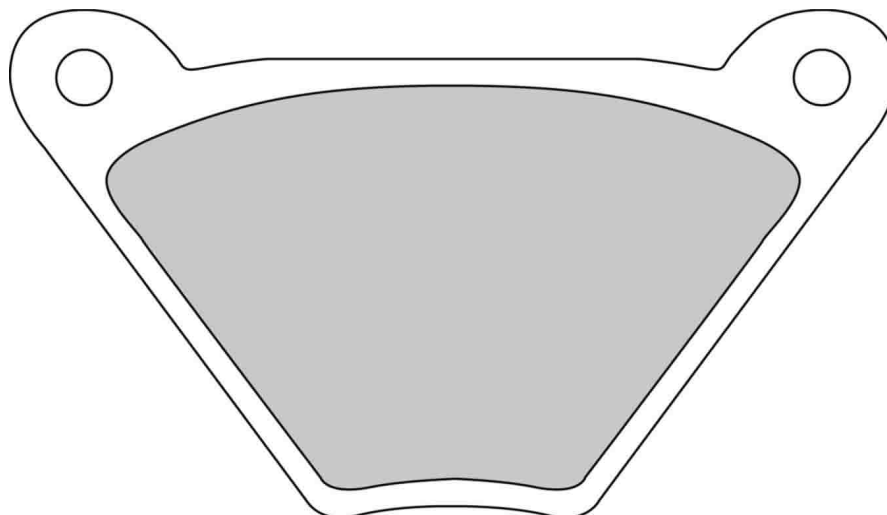

CROSS REFERENCE	
BREMBO	07HD01
CL BRAKES	2599
EBC	FA024/2
GALFER	FD019
LUCAS/TRW	MCB97
NEWFREN	FD0151
SBS	513
VESRAH	VD-915

		CC	KW	FROM	TO	FRONT / REAR	LEFT / RIGHT
	HARLEY DAVIDSON						
M	FL / FLH Electra Glide (4-speed)	1340		1972		F	
M	FL / FLH Electra Glide (4-speed)	1340		1973	1980	F	
M	FL / FLH Electra Glide (4-speed)	1340		1973	1980	R	
M	FL / FLH Electra Glide (4-speed)	1340		1981	1984	F	
M	FLHS Electra Glide Sport	1340		1977		F	
M	FLHS Electra Glide Sport	1340		1977		R	
M	FX Super Glide	1340		1973		F	
M	FX Super Glide	1340		1973		R	
M	FX Super Glide	1340		1974	1977	R	

		CC	KW	FROM	TO	FRONT / REAR	LEFT / RIGHT
							
M	FX Super Glide	1340		1978	1981	R	
M	FXB Sturgis Belt	1340		1977	1981	R	
M	FXE Super Glide	1340		1973		F	
M	FXE Super Glide	1340		1973		R	
M	FXE Super Glide	1340		1974	1977	R	
M	FXE Super Glide	1340		1978	1981	R	
M	FXEF Super Glide	1340		1978	1981	R	
M	FXS Sturgis	1340		1977	1981	R	
M	FXWG Wide Glide	1340		1980	1981	R	

FDB204

60.0 x 59.0 x 9.0 mm

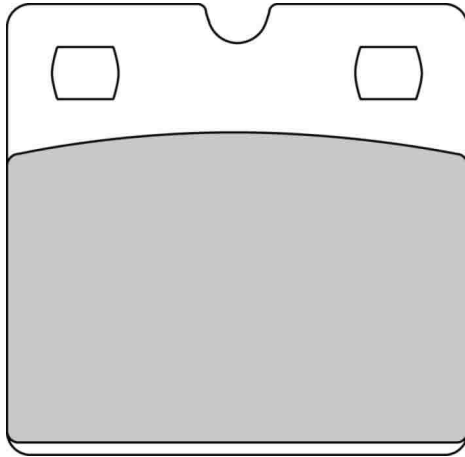

MATERIAL AVAILABILITY											
AG	EF	P	PRP	ST	SM	SG	ZR	XRAC	ZRAC	CP1	CPRO
		✓									

Pinze / Calipers

BREMBO

2-Piston/Large (F09)

CROSS REFERENCE

BRAKING	644
BREMBO	07BB23
CL BRAKES	2840
EBC	FA077
GALFER	FD044
LUCAS/TRW	MCB533
NEWFREN	FD0044
SBS	554
VESRAH	VD-933

		CC	KW	FROM	TO	FRONT REAR	LEFT RIGHT
	APRILIA	M	ST 125	125		1987	F
		M	STX 125	125		1986	F
	BENELLI	M	900 SEI	900		1978	R
	BMW	M	R 65 650 GS	650		1989 1992	F
		M	K 75 750 S	750		1994 2000	F

		CC	KW	FROM	TO	FRONT REAR	LEFT RIGHT
	MOTO GUZZI	M	K 75 750 S	750		1994 2000	R
		M	R 80 800 GS / PARIS-DAKAR	800		1987 1995	F
		M	R 80 RT	800		1990 1994	F
		M	R 100 1000 GS / PARIS-DAKAR	1000		1987 1994	F
		M	SP 1000	1000		1978 1983	R

M = MOTORCYCLE
S = SCOOTER
A = ATV
Sn = SNOWMOBILE

FDB205

49.0 x 58.5 x 7.0 mm

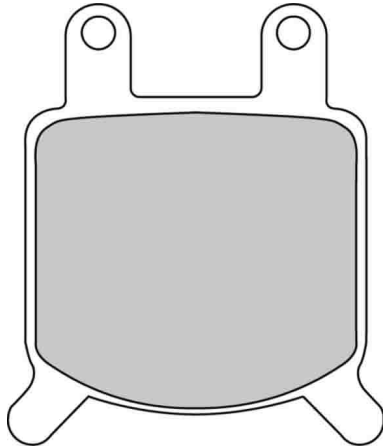

MATERIAL AVAILABILITY											
AG	EF	P	PRP	ST	SM	SG	ZR	XRAC	ZRAC	CP1	CPRO
		✓									

Pinze / Calipers

GMA

B Series (2-Piston)

Grimeca

2-Piston, medium (four tab, 1010)

Jaybrake

2 & 4* Piston, large

CROSS REFERENCE

BREMBO	07GR02
EBC	FA076
GALFER	FD028
LUCAS/TRW	MCB536
NEWFREN	FD0028
SBS	560
VESRAH	VD-928

		CC	KW	FROM	TO	FRONT / REAR	LEFT / RIGHT
	ASPES	M DUMA 125	125			F	
	BETA	M CUSTOM 125	125	1982		F	
		M CUSTOM 250	250	1982		F	
	GARELLI	M TSR 125 SELF MIX	125			F	
	GILERA	M TG1 80	80			F	
		M TG2 80	80			F	
		M TG3 80	80			F	
		M GR1 125	125			F	
		M TG1 125	125			F	
		M TG2 125	125			F	
		M TG3 125	125			F	
		M T4 200	200			F	
		M T4C 200	200			F	
		M T4S 200	200			F	
	KREIDLER	M MUSTANG 125	125	1983		F	
	MOTO MORINI	M MONOCILINDRO 125	125	1979		F	

		CC	KW	FROM	TO	FRONT / REAR	LEFT / RIGHT
	M	BICILINDRO 250	250		1979	F	
	M	MONOCILINDRO 250	250			1981	F
	M	SPORT 250	250			1970	F
	M	TURISMO 250	250			1970	F
	M	GT 350	350	1976		1981	F
	M	GT 350	350	1979			F
	M	GT 350 TURISMO	350	1980			F
	M	SPORT 350	350			1980	F
	M	SPORT 350	350			1980	R
	M	SPORT 350	350	1980			F
	M	SPORT 350	350	1981			F
	M	T.T. 500	500			1980	F
	ZUNDAPP	M K 80	80			1980	F
		M KS 80	80			1980	F
		M KS 125	125			1980	F

FDB207

40.0 x 57.0 x 7.0 mm

July 2016: AG compound superseded by EF

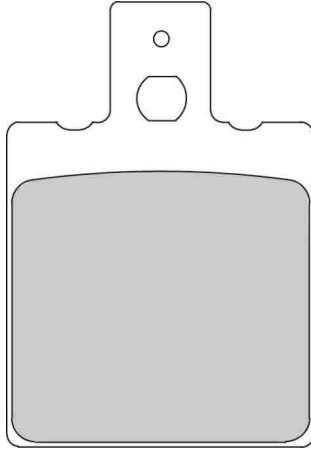

MATERIAL AVAILABILITY											
AG	EF	P	PRP	ST	SM	SG	ZR	XRAC	ZRAC	CP1	CPRO
✗	✓	✓		✓		✗				✓	

Pinze / Calipers

BERINGER

6 Piston

BREMBO

2-Piston/Small (F05)

HARRISON Billet

4 Piston old style

6 Piston old style

ISR

2-Piston (22-029)

Pro-One

Pro-One 2-Piston - Old

Pro-One 6-Piston - New **

CROSS REFERENCE

BRAKING	612
BREMBO	07BB01
BRENTA	3029
BRENTA	4029
CL BRAKES	2249
EBC	FA047
GALFER	FD012
GALFER	FD170
GOLD FREN	038
LUCAS/TRW	MCB75
NEWFREN	FD0012
SBS	138
SBS	519
SBS	583
VESRAH	VD-911

		CC	KW	FROM	TO	FRONT / REAR	LEFT / RIGHT
	ACCOSSATO	M CE 50	50	1987		F	
		M 50 ENDURO CODICE	50	1989		F	
		M CE 80	80	1987		F	
		M CE 80	80	1987		R	
		M KR 80	80	1987		F	
	ALFER	M MC 80	80	1988		F	
		M MC 80 CROSS	80	1989		F	
		M MC 80 CROSS	80	1989		R	
		M MC 125	125	1987	1987	F	
		M MC 125	125	1987	1987	R	
M MC 125		125	1988		R		
M GR 250 ENDURO		250	1985	1987	F		
M GR 250 ENDURO		250	1985	1987	R		
M GR 250 ENDURO		250	1988		R		
M MC 250		250	1985	1986	F		
M MC 250	250	1987	1987	F			
M MC 250	250	1987	1987	R			
M MC 250	250	1988		R			
M GR 300 ENDURO	300	1985	1987	F			
M GR 300 ENDURO	300	1985	1987	R			
M TX 300	300	1990		R			
APRILIA	M RS 50	50	1993	1998	F		
	M RX 50	50	1996	1998	F		
	M TUAREG 50 HPC SYSTEM	50	1987		R		
	M TUONO 50	50	2003	2004	R		
	M AF1 125	125	1987		R		
	M AF1 125 REPLICIA	125	1989	1991	R		
	M AF1 125 SINTESI	125	1989	1991	R		
	M AF1 125 FUTURA	125	1990	1991	R		
	M AF1 125 EUROPA	125	1990	1991	R		

		CC	KW	FROM	TO	FRONT / REAR	LEFT / RIGHT
	M AF1 FUTURA SPORT PRO 125	125		1993	2003	R	
	M CLASSIC 125	125		1996		R	
	M ETX 125	125		1985	1986	F	
	M LEONARDO 125	125		1995	1996	F	
	M RS 125 EXTREMA - REPLICIA	125		1993	1997	R	
	M RS 125	125		1998	1999	R	
	M RS 125	125		2000	2003	R	
	M RS 125	125		2004	2006	R	
	M TUAREG 125	125		1986		R	
	M TUAREG 125	125		1987		R	
M TUAREG 125 WIND	125		1990		R		
M TUONO 125 2T	125		2003	2004	R		
M CLIMBER 200	200		1993		F		
M CLIMBER 200	200		1993		R		
M MX 250	250		1983	1983	F		
M RS 250	250		1995	1996	R		
M RS 250	250		1998		R		
M RX 250	250		1983		F		
M RX 250	250		1986		F		
M ETX 350	350		1986		R		
M ETX 350 AE	350		1987		R		
M TUAREG 350	350		1987		R		
M TUAREG 350 WIND	350		1987	1988	R		
M ETX 600	600		1986		R		
ATK (USA)	M all models 1984-85			1984	1985	F	
	M all models 1986			1986		F	
	M all models 1987			1987		F	
M 560	560		1984	1985	F		
M 560	560		1986	1987	F		
BENELLI	M 125	125		1976		F	

M = MOTORCYCLE
S = SCOOTER
A = ATV
Sn = SNOWMOBILE



		CC	KW	FROM	TO	FRONT / REAR	LEFT / RIGHT
M	125 2C Dual brakes	125		1976		F	
M	125 2C	125		1976	1978	F	
M	125 2T - 2 CSE	125		1976	1978	F	
M	250 4	250		1976		F	
M	BX Motard (250cc)	250		2012		R	
M	250 C	250		1976	1978	F	
M	250 TS	250		1976	1978	F	
M	350	350		1983		F	
M	350	350		1983		R	
M	350 4 CIL.	350		1978		F	
M	350 SPORT	350		1978		F	
M	350 SPORT II	350		1978		F	
M	350 T	350		1978		F	
M	500	500		1978		F	
M	500 LS	500		1978		F	
M	500 QUATTRO	500		1976		F	
M	650	650		1982		F	
M	650 SPORT	650		1978		F	
M	650 T	650		1978		F	
BETA	M KR 125	125		1986		F	
M	KR 125 AFRIKA	125		1987		F	
M	ALP 240	240		1996		R	
M	CR 250	250		1983		F	
M	KR 250 AFRIKA	250		1986		F	
M	KR 250 RALLY	250		1987		F	
M	GS - RV 500	500		1984		F	
BIMOTA	M YB 7 400	400		1989		R	
M	V DUE 500	500		1997		R	
M	YB 9 600 SRI	600		1997		R	
M	SUPERMONO 650	650		1997		R	
M	SB 7 750	750		1996		R	
M	YB 4 750	750		1989		R	
M	DB 1 - 2 900	900		1992		R	
M	MANTRA 900	900		1997		R	
M	DB 2 SR 904	904		1994	2000	R	
M	DB 4 904	904		1998	1999	R	
M	SB8K Gobert (Suzuki Engine) (996cc)	996		2006		R	
M	SB 8 1000 R	1000		1998		R	
M	YB 10 1000 BIPOSTO	1000		1992		R	
M	YB 11 1000	1000		1997		R	
M	YB 6 1000	1000		1989		R	
M	YB 8 1000 E.I. FURANO	1000		1990		R	
M	YB 8 1000 E	1000		1990		R	
M	YB 8 FURANO 1000	1000		1992		R	
M	DB5R/S (1078cc)	1078		2008	2009	R	
M	DB6 (1078cc)	1078		2008	2009	R	
M	DB6/R (1078cc)	1078		2008	2009	R	
M	Tesi 3D (1078cc)	1078		2009		R	
M	DB7 (1099cc)	1099		2009		R	
M	SB 6 1100	1100		1997		R	
CAGIVA	M COCIS 50	50		1988		F	
M	COCIS 50	50		1989		F	
M	COCIS 50	50		1989		R	
M	CUCCILO 50	50		1997		F	
M	LUCKY EXPLORER 50	50		1988		F	
M	SUPERCITY 50	50		1993		R	
M	W4 PRO ACTION 50	50		1994		F	
M	COCIS 80	80		1989		F	
M	SUPERCITY 80	80		1994		F	
M	W4 PRO ACTION 80	80		1994		F	
M	BLUES 125	125		1988	1992	R	
M	ELEFANT 125	125		1987		F	
M	FRECCIA 125	125		1987		R	
M	FRECCIA 125 C9	125		1988		R	
M	FRECCIA 125 C10 R	125		1988		R	
M	FRECCIA 125 C10	125		1988		R	
M	FRECCIA 125 C10 ANNIVERSARIO	125		1989		R	
M	FRECCIA 125 C12 R	125		1989	1990	R	
M	FRECCIA 125 C12 R	125		1991		R	
M	K7 125 ENDURO	125		1991		R	
M	MITO 125	125		1991	1992	R	
M	MITO 125	125		1993		R	
M	MITO 2 125 PRODUCTION RACER / Trofeo	125		1994		R	
M	MITO 525SP	125		2007		R	
M	PLANET 125	125		1998		R	
M	RAPTOR 125	125		2003		R	
M	SUPERCITY 125	125		1994		R	
M	W8 125 PRO ACTION	125		1992	1995	R	
M	WMX 125 CROSS	125		1986		F	
M	ALA BLU 250	250		1983		F	



		CC	KW	FROM	TO	FRONT / REAR	LEFT / RIGHT
M	ALA ROSSA 250	250		1983		F	
M	ALA VERDE 250	250		1983		F	
M	SST 250	250		1980		F	
M	SSX 250	250		1982		F	
M	ST 250	250		1982		F	
M	SX 250	250		1982		F	
M	WMX 250	250			1982	F	
M	WMX 250 /1	250		1983		F	
M	WRX 250	250		1983		F	
M	ALA AZZURRA 350	350		1983		F	
M	ALA AZZURRA 350 GT	350		1987		F	
M	ALA BLU 350	350		1983		F	
M	ALA ROSSA 350	350		1983		F	
M	ALA ROSSA 350	350		1988		F	
M	ALA VERDE 350	350		1983		F	
M	ELEFANT 350	350		1985		R	
M	SST 350	350		1981		F	
M	SX 350	350		1982		F	
M	T4 350 R - ER	350		1987		F	
M	W 12 350	350		1992		R	
M	T4 500 E - ER	500		1987		F	
M	WMX 500	500		1984		F	
M	RIVER 600	600		1994		R	
M	ALA AZZURRA 650	650		1984		F	
M	ALA AZZURRA 650	650		1984		R	
M	ALA AZZURRA 650 GT	650		1987		R	
M	ELEFANT 650	650		1985		R	
M	W 16 650	650		1993		R	
M	DAKAR 750	750		1987		R	
M	ELEFANT 750	750		1987		R	
CZ	M CZ 180	180		1993		F	
DERBI	M TT8 75	75		1984		F	
DUCATI	M 502 SINGLE	50		1993	1999	R	
M	502 SUPERMONO	50		1993	1999	R	
M	350 S-GTL	350		1975		F	
M	350 S-GTL	350		1975		R	
M	350 SPORT GTV-SL-XL	350		1975		F	
M	350 SPORT GTV-SL-XL	350		1975		R	
M	350 F3	350		1986		F	
M	350 F3	350		1986		R	
M	350 INDIANA	350		1987		R	
M	400 DESMO F3	400		1987		F	
M	400 DESMO F3	400		1987		R	
M	400 MONSTER	400		1995	1997	R	
M	400 MONSTER (JAPAN)	400		2000		R	
M	SS 400 JUNIOR	400		1992		R	
M	SS 400 NUDA	400		1992		R	
M	500 GTL SPORT DESMO	500		1975		F	
M	500 GTL SPORT DESMO	500		1975		R	
M	500 GTV	500		1977		F	
M	500 GTV	500		1977		R	
S	500 PANTAH	500		1977		F	
S	500 PANTAH	500		1977		R	
M	S 500	500		1975		F	
M	S 500	500		1975		R	
M	550 SUPERMONO	550		1993	1999	R	
M	600 SUPERSPORT CARENATA	600		1994	1999	R	
M	600 SUPERSPORT NUDA	600		1994	1999	R	
M	M 600 MONSTER	600		1993	1999	R	
M	M 600 MONSTER	600		2000	2000	R	
M	M 620 MONSTER DARK (single/twin disc)	620		2003		R	
M	MULTISTRADA DARK 620	620		2003	2005	R	
M	MULTISTRADA 620 (twin disc)	620		2005	2006	R	
M	650 INDIANA	650		1986	1987	F	
M	650 INDIANA	650		1986	1987	R	
M	650 DESMO	650		1987		R	
M	650 INDIANA	650		1987		R	
M	748 BIPOSTO	748		1995	1997	R	
M	748 RACING CLIENTI	748		1995	1997	R	
M	748 BIPOSTO	748		1998		R	
M	748 RACING CLIENTI	748		1998		R	
M	750 F1 DESMO	750		1986		R	
M	750 SUPERSPORT	750		1992	1997	R	
M	M 750 MONSTER	750		1996	1999	R	
M	M 750 MONSTER	750		2000	2000	R	
M	SS 750 NUDA	750		1992	1998	R	
M	SS 750 CARENATA	750		1993	1998	R	
M	MONSTER 800	800		2003	2006	R	
M	MONSTER S2R 800	800		2007		R	
M	851 all models	851		1988	1992	R	

		CC	KW	FROM TO		FRONT / LEFT / REAR / RIGHT	
				FROM	TO	FRONT / REAR	LEFT / RIGHT
	M 880 RACING	880		1994	1995	R	
	M 888 all models	888		1992	1995	R	
	M 900 all models	900		1992	1998	R	
	M 900 I.E. PASO	900		1992	1998	R	
	M 900 SUPERMONO DESMO 4	900		1993	1995	R	
	M M 900 MONSTER	900		1993	1999	R	
	M M 900 MONSTER I.E.	900		2000		R	
	M 916 STRADA / SENNA / SP / SPS	916		1994	1997	R	
	M 916 RACING CLIENTI	916		1995	1998	R	
	M M 916 MONSTER S4	916		2001	2002	R	
	M 996 BIPOSTO	996		1999		R	
	M 998 R	998		2002		R	
	M 998 S	998		2002		R	
	M 998 SFE	998		2003		R	
	M MONSTER 1000	1000		2003	2006	R	
	M MONSTER S4R /S4RS 1000	1000		2006	2007	R	
	M MONSTER S2R 1000	1000		2007	2007	R	
	M MONSTER S4R S Testastretta/tricolore	1000		2008		R	
FANTIC	M CABALLERO 50 RC	50		1990		F	
GARELLI	M URKA 50	50		1991		F	
	M TIGER 125 XR	125				F	
	M TIGER 125 XRD	125				F	
GILERA	M ARIZONA 125	125		1983		F	
	M CMM APTS 125	125		1987		R	
	M CRONO 125	125		1991		R	
	M CX 125	125		1991		R	
	M FAST BIKE 125	125		1987		R	
	M GFR 125	125		1993		R	
	M HX 125 LC	125		1983		F	
	M KK 125 APTS	125		1987		R	
	M KZ 125	125		1986		R	
	M KZ 125 ENDURANCE	125		1988		R	
	M MX 1 125	125		1988		R	
	M MX R 125	125		1990		R	
	M R1 125 S	125		1988		R	
	M RX 125	125		1984		F	
	M SP 01 125	125		1989		R	
	M SP 02 125	125		1990		R	
	M XR1 125	125		1988		R	
	M XR2 125	125		1989		R	
	M FAST BIKE 200	200		1987		R	
	M RV 200	200		1985		R	
	M RV 200 ES	200		1987		R	
	M RX 200 ARIZONA	200		1985		F	
	M RX 200	200		1985		F	
	M HX 250 LC	250		1983		F	
	M NGR 250	250		1985		R	
	M RC 250 RALLY	250		1987		R	
	M RX 250 ARIZONA RALLY	250		1986		F	
	M XRT 350	350		1990		R	
	M SATURNO 500 PIUMA	500		1990		R	
	M XRT 600	600		1988		R	
HERCULES (SACHS)	M Lotus 80 SW	80				F	
HRD	M PLATINO 125 ST	125		1986		F	
	M ROAD 125 ST	125		1986		F	
HUSQVARNA	M CR 125	125		1985	1995	F	
	M WR 125	125		1986	1986	F	
	M WR 240	240		1986		F	
	M CR 250	250		1985	1995	F	
	M WR 400	400		1986		F	
	M CR 500	500		1985		F	
	M 510	510		1986		F	
ITALJET	M BOSS 350 ENDURO	350				F	
	M CX 350	350		1985		F	
	M ROAD MASTER 350	350				F	
KEEWAY	S ARN 50 (25/45)	50		2010	2011	F	
	S Hacker 50	50		2008	2009	F	
	S ARN 125	125		2006	2012	F	
	S Hacker 125	125		2008	2010	F	
	S Arn 150	150		2006	2009	F	
	S Hacker 150	150		2008	2010	F	
KTM	M COMET 50 PL-RL-RLW-RS4L-TS	50				F	
	M MX 50	50		1987		F	
	M RSV 50	50		1986		F	
	M L-PL-RL-RS-RSL-BORA 80	80				R	
	M L-PL-RL-RS-RSL-BORA 80	80				R	
	M MX 80 GR - SUPER MINI	80		1986		F	
	M BAJA 125	125		1986		F	
	M GS 125 XC ENDURO SPORT	125		1986	2000	F	
	M GS 125 XC ENDURO SPORT	125		1986	2000	R	

		CC	KW	FROM TO		FRONT / LEFT / REAR / RIGHT	
				FROM	TO	FRONT / REAR	LEFT / RIGHT
	M MX 125 CROSS	125		1985		F	
	M MX 125 CROSS	125		1986		F	
	M MX 125 CROSS	125		1986		R	
	M BAJA 250	250		1986		F	
	M GS 250 XC ENDURO SPORT	250		1986	2000	F	
	M GS 250 XC ENDURO SPORT	250		1986	2000	R	
	M MX 250 CROSS	250		1985		F	
	M MX 250 CROSS - DIG.CONTR.	250		1986		F	
	M MX 250 CROSS - DIG.CONTR.	250		1986		R	
	M GS 300 XC ENDURO SPORT	300		1986	2000	F	
	M GS 300 XC ENDURO SPORT	300		1986	2000	R	
	M COUNTRY 350 CROSS E	350		1985		F	
	M GS 350 ENDURO SPORT	350		1983		F	
	M GS 390 ENDURO SPORT	390		1983		F	
	M MX 495 MC LELEU	495		1982	1983	F	
	M GS 500 K4 ENDURO	500		1983		F	
	M MX 500 CROSS	500		1985		F	
	M MX 500 CROSS	500		1986	2000	F	
	M MX 500 CROSS	500		1986	2000	R	
	M GXE 550	550		1986	2000	F	
	M GXE 550	550		1986	2000	R	
	M ENDURO 600 all models	600		1986	2000	F	
	M ENDURO 600 all models	600		1986	2000	R	
	M GS 600 ENDURO SPORT	600		1985		F	
	M XC-XCE 600 CROSS COUNTRY-BAJA	600		1985		F	
LAVERDA	M OR 50 ATLAS	50		1987		F	
	M OR 50 ATLAS	50		1987		R	
	M 125	125			1982	F	
	M GS 125 LESMO	125		1986		F	
	M GS 125 LESMO	125		1986		R	
	M 350	350		1980		F	
	M 350	350		1980		R	
	M ALPINO 500	500		1977		F	
	M ALPINO 500	500		1977		R	
	M PF 500	500		1977		F	
	M PF 500	500		1977		R	
	M RS 500	500		1977		F	
	M RS 500	500		1977		R	
	M OR 600	600		1986		F	
	M 650 (all models)	650		1995	1996	R	
	M LYNX 650	650		2000		R	
	M GHOST - DIAMANTE 668	668		1997	1998	R	
	M CUP 750	750		1998		R	
	M DIAMANTE 750	750		1997		R	
	M 750 S (all models)	750		1999		R	
	M JOTA 1000	1000		1995		R	
MAICO	M GM 250 CROSS	250		1984		F	
	M GME 250 ENDURO	250		1984		F	
	M GM 500 CROSS	500		1984		F	
	M GME 500 ENDURO	500		1984		F	
MALANCA	M E2 C 80 CS	80				F	
	M E2 C 80 CS	80				R	
	M GTI 125	125				F	
	M GTI 125	125				R	
	M MARK 125 ENDURO	125				F	
MONTESA	M COTA 309	309		1989		R	
	M COTA 314 R	314		1994		R	
MONTESA (HONDA)	M MH 311 260	260		1992	1993	R	
	M COTA 310	310		1989		R	
	M COTA 310 4T / 4RT	310		2007		R	
	M MH 314 R	314		1994	1997	R	
	M MH 315 R	315		1997	2000	R	
MOTO GUZZI	M 2C 125 4T	125		1979		F	
	M TT 125	125		1985		F	
	M TS 250	250		1974	1975	F	
	M TS 250	250		1976	1982	F	
	M TS 250	250		1976	1982	R	
	M GTS 350	350		1974	1979	F	
	M GTS 350	350		1974	1979	R	
	M NEVADA 350	350		1993		F	
	M NEVADA 350	350		1993		R	
	M NTX 350	350		1987		F	
	M NTX 350	350		1987		R	
	M NTX 350	350		1990		F	
	M V 35 350 IMOLA	350		1970	1983	F	
	M V 35 350 IMOLA	350		1970	1983	R	
	M V 35 350	350		1977		F	
	M V 35 350	350		1977		R	
	M V 35 350 C	350		1982		F	
	M V 35 350 C	350		1982		R	

M = MOTORCYCLE
 S = SCOOTER
 A = ATV
 Sn = SNOWMOBILE



		CC	KW	FROM	TO	FRONT / REAR	LEFT / RIGHT
	M V 35 350 TT ENDURO	350		1984		F	
	M V 35 350 TT ENDURO	350		1984		R	
	M V 35 350 IMOLA II	350		1984		F	
	M V 35 350 IMOLA II	350		1984		R	
	M V 35 350 FLORIDA	350		1987		F	
	M V 35 350 FLORIDA	350		1987		R	
	M V 35 350 GT	350		1990		R	
	M GTS 400	400		1974	1979	F	
	M GTS 400	400		1974	1979	R	
	M V 50 500	500		1977	1980	F	
	M V 50 500	500		1977	1980	R	
	M V 50 500 III	500		1980		F	
	M V 50 500 III	500		1980		R	
	M V 50 500 MONZA	500		1980	1983	F	
	M V 50 500 MONZA	500		1980	1983	R	
	M V 50 500 C	500		1982		F	
	M V 50 500 C	500		1982		R	
	M V 50 500 MONZA II	500		1984		F	
	M V 50 500 MONZA II	500		1984		R	
	M NTX 650	650		1990		F	
	M V 65 650 SP CHOPPER	650		1981		F	
	M V 65 650 SP CHOPPER	650		1981		R	
	M V 65 650	650		1981	1983	F	
	M V 65 650	650		1981	1983	R	
	M V 65 650 LARIO	650		1984		F	
	M V 65 650 LARIO	650		1984		R	
	M V 65 650 II ENDURO	650		1984		F	
	M V 65 650 II ENDURO	650		1984		R	
	M VT 650 TT BAJA	650		1986		R	
	M V 65 650 FLORIDA	650		1987		F	
	M V 65 650 FLORIDA	650		1987		R	
	M V 65 650 GT	650		1990		R	
	M SP 750 NEVADA	750		1992		F	
	M SP 750 NEVADA	750		1992		R	
	M SP 750 NEVADA CLUB	750		2000	2002	F	
	M SP 750 NEVADA CLUB	750		2000	2002	R	
	M T 750	750		1992	1994	F	
	M T 750	750		1992	1994	R	
	M QUOTA 1000	1000		1993	1995	R	
	M LE MANS V 11	1064		2001		R	
	M SPORT 1100	1100		1994	1999	R	
MOTO MORINI	M CAMEL 501	50			1986	F	
	M CAMEL 501	50		1987		R	
	M COGUARO 501	50		1989		R	
	M EXCALIBUR 501	50		1987	1988	R	
	M EXCALIBUR 501	50		1989		R	



		CC	KW	FROM	TO	FRONT / REAR	LEFT / RIGHT
	M NEW YORK 501	50		1989		R	
	M BLUES 125	125		1993		R	
	M COGAURO 350	350		1990		R	
	M DART 350	350		1988	1989	R	
	M DART 350	350		1990		R	
	M EXCALIBUR RLX 350	350		1990		R	
	M KANGURO 350	350		1987		R	
	M NEW YORK 350	350		1989		R	
	M WS 350 PRO ACTION	350		1993		R	
	M DART 400	400		1990		R	
MZ	M SKORPION CUP / SPORT / TOUR / TRAVELLER	660		1995		R	
	M SKORPION REPLICA	660		1995		R	
NORTON	M FORMULA 1	588		1989	1991	R	
PUCH	M MAXI 80	80		1988		R	
	M CROSS 250	250		1986	1986	F	
	M HFE 250	250		1986	1986	F	
	M ENDURO 600 4 VALVES	600		1985		F	
	M ENDURO 600 4 VALVES	600		1985		R	
SWM	M S1 125	125		1983		F	
	M S2 125	125		1983		F	
	M S1 250	250		1983		F	
	M S2 250	250		1983		F	
TM	M GS 80	80		1986	1989	R	
	M MC 80	80		1986	1989	R	
	M GS 125	125		1986	1989	R	
	M MC 125	125		1986	1989	R	
	M SMM 125 Black Dream (Rim front disc)	125		2004	2007	R	
	M SMM 125 (2T) Black Dream (320mm front disc)	125		2008	2012	R	
	M SMM 250 (2T)	250		2005	2014	R	
	M SMM 250 (2T)	250		2015		R	
	M SMM 300 (2T)	300		2005	2014	R	
	M SMM 300 (2T)	300		2015		R	
	M SMM 400 (4T) (Rim brake)	400		2004	2004	R	
	M SMM 450 F Black Dream ES (320mm front disc)	450		2008	2010	R	
	M SMM 450 Fi (4T)	450		2011		R	
	M SMM 530 F Black Dream (Rim brake)	530		2004	2007	R	
	M SMM 530 F Black Dream ES (320mm front disc)	530		2008	2010	R	
	M SMM 530 Fi (4T)	530		2016		R	
	M SMR 530 Fi ES	530		2015		R	
TORNAX	M RX 80	80				F	
TRE SOLDI	M CR 80	80		1985		F	
YAMAHA	M TDR 125	125		1992		R	
	M TZR 125 (Italia)	125		1991		R	
	M TZR 125 RED ROCKET	125		1993		R	
	M SZR 660	660		1996	1997	R	
ZUNDAPP	M KS 80 SUPER	80		1980		F	

FDB213

41.4 x 48.5 x 5.6 mm

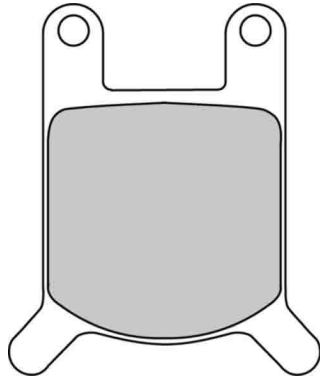

MATERIAL AVAILABILITY

AG	EF	P	PRP	ST	SM	SG	ZR	XRAC	ZRAC	CP1	CPRO
		✓									

Pinze / Calipers

Grimeca

2-Piston, small (four tab, 1000T)

CROSS REFERENCE

BREMBO	07GR01
EBC	FA050
GALFER	FD031
LUCAS/TRW	MCB508
NEWFREN	FD0031
SBS	532
VESRAH	VD-912

		CC	KW	FROM	TO	FRONT REAR	LEFT RIGHT
	ATK (USA)	M			1986		R
		M			1988		R
		M	560		1986	1987	R
	BENELLI	M	254		1979		F
	BETA	M	50		1980		F
		M	50		1983		F
	CASAL	M	50				F
	CIMATTI	M	50				F
	FANTIC	M	50		1973		F
	GARELLI	M	50				F
	HERCULES (SACHS)	M	50				F
		M	50				F
		M	50				F
		M	50				F
		M	50				F
		M	80				F
		M	80				F
		M	80				F
		M	80				F
		M	125				F
	HOREX	M	80				F
		M	80				F
		M	80				F
	MACAL	M	50		1999		F
	MALAGUTI	M	25		1982		F
		M	40		1982		F
		M	50		1982		F

		CC	KW	FROM	TO	FRONT REAR	LEFT RIGHT
	M	GRIZZLY 50 RCX / "12"	50		1987		F
	M	LX 50 SPORT	50			1982	F
	M	RCW 50 RONCO	50			1982	F
	M	VA 50 OLYMPIQUE	50			1982	F
	M	WC 50 WATERCOOLED	50			1982	F
	M	CHOPPER 80	80			1982	F
	MALANCA	M	50				F
		M	54				F
		M	125				F
	MOTO GUZZI	M	125		1974	1981	F
	MOTRON	M	50				F
	OSSA	M	360				F
		M	360				R
	PUCH	M	50				F
		M	50		1984		F
		M	80				F
		M	348				F
		M	504				F
		M	506				F
		M	560 (Rotax engine)				F
	REAL	M	80				F
	RIXE	M	80				F
	ZUNDAPP	M	50				F
		M	50				F
		M	100				F

FDB217

72.0 x 45.0 x 11.4 mm

MATERIAL AVAILABILITY

AG	EF	P	PRP	ST	SM	SG	ZR	XRAC	ZRAC	CP1	CPRO
		✓									

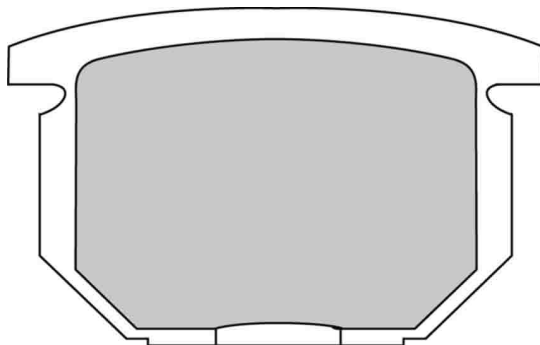

CROSS REFERENCE

BREMBO	07SU04
EBC	FA065
GALFER	FD047
LUCAS/TRW	MCB501
NEWFREN	FD0047
SBS	534
VESRAH	VD-324



		CC	KW	FROM	TO	FRONT / REAR	LEFT / RIGHT
SUZUKI	M GS 550 LT - LX	550		1980	1984	F	
	M GS 550 ET - EX - EZ	550		1980	1984	F	
	M GS 550 MEX	550		1981	1983	F	
	M GS 550 MEZ KATANA	550		1981	1983	F	
	M GR 650 - X	650		1983		F	
	M GS 650 GZ KATANA	650		1981	1983	F	
	M GS 650 GTX - GTZ - GX	650		1981	1983	F	



		CC	KW	FROM	TO	FRONT / REAR	LEFT / RIGHT
	M GS 650 XN - 85 TURBO	650		1983		F	
	M GS 650 TURBO	650		1983		F	
	M GS 1000 ET	1000		1980	1981	F	
	M GSX 1000 S KATANA	1000		1982		F	
	M GSX 1100 G	1100		1980	1982	F	
	M GSX 1100 E - EF - ES	1100		1980	1982	F	
	M GSX 1100 S KATANA	1100		1982	1983	F	

FDB218

78.0 x 50.0 x 10.8 mm

MATERIAL AVAILABILITY											
AG	EF	P	PRP	ST	SM	SG	ZR	XRAC	ZRAC	CP1	CPRO
		✓		✗							

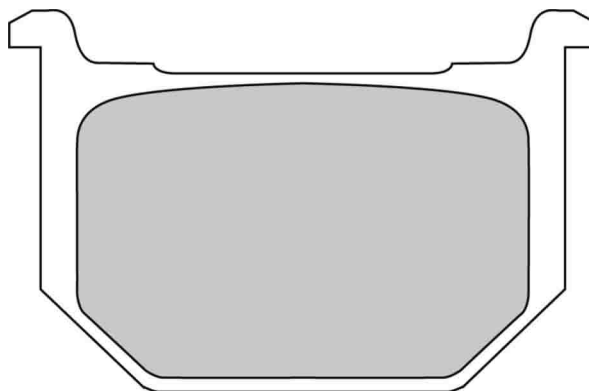

CROSS REFERENCE	
BRAKING	646
BREMBO	07SU03
CL BRAKES	2694
EBC	FA051
GALFER	FD046
LUCAS/TRW	MCB59
NEWFREN	FD0046
SBS	533
VESRAH	VD-322
VESRAH	VD-912

		CC	KW	FROM	TO	FRONT / RÉAR	LEFT / RIGHT
	SUZUKI						
M	GN 250	250		1993	1997	F	
M	GN 250 F / J	250		1983	1997	F	
M	GNX 250 E	250		1983		F	
M	GS 250 E	250		1979	1981	F	
M	GS 250 T - TT - TX	250		1979	1981	F	
M	GSX 250 E - ET - EX - EZ - T	250		1979		F	
M	GSX 250 S	250		1985	1990	F	
M	GN 400 TT	400		1980		F	
M	GSX 400 L	400		1980	1983	F	
M	GSX 400 ET - EX - EZ	400		1980	1983	F	
M	GSX 400 TWIN	400		1980	1983	F	
M	GSX 400 TX - LX	400		1981	1983	F	

		CC	KW	FROM	TO	FRONT / RÉAR	LEFT / RIGHT
							
M	GS 450 ET - L - T	450		1980	1980	F	
M	GS 700 E - ES	700		1985		F	
M	GV 700 GL MADURA	700		1984		F	
M	GV 700 GL	700		1985		F	
M	GSX 750 EFE - ESD - ESG - ESE - SEH - EFF	750		1980	1986	F	
M	GSX 750 ET - EX	750		1980	1981	F	
M	GSX 750 S KATANA	750		1980		F	
M	GS 850 GZ - GE - GG	850		1982	1985	F	
M	GS 1000 GT - GX	1000		1980		F	
M	GS 1100 GZ	1100		1982		F	
M	GV 1200 GL MADURA	1200		1985	1986	F	

M = MOTORCYCLE
S = SCOOTER
A = ATV
Sn = SNOWMOBILE

FDB220

51.0 x 55.0 x 12.2 mm

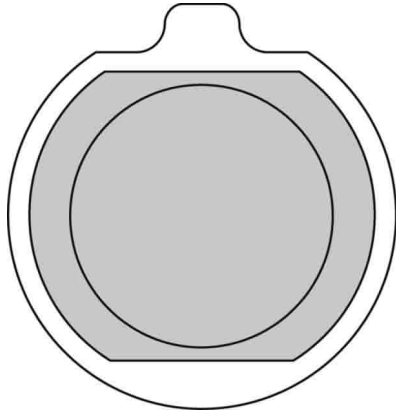

MATERIAL AVAILABILITY											
AG	EF	P	PRP	ST	SM	SG	ZR	XRAC	ZRAC	CP1	CPRO
		✓		✓							

CROSS REFERENCE	
BREMBO	07KA04
EBC	FA062
NEWFREN	FD0055
SBS	530
VESRAH	VD-423

		CC	KW	FROM	TO	FRONT REAR	LEFT RIGHT
 KAWASAKI	M Z 1000 E1 - E2 - SHAFT - ST	1000		1979	1981	F	
	M Z 1300	1300		1979	1983	F	

		CC	KW	FROM	TO	FRONT REAR	LEFT RIGHT
 M	ZG 1300 DF1	1300		1984	1986	F	

FDB244

90.0 x 49.0 x 10.5 mm

MATERIAL AVAILABILITY											
AG	EF	P	PRP	ST	SM	SG	ZR	XRAC	ZRAC	CP1	CPR0
	✓	✓		✓							

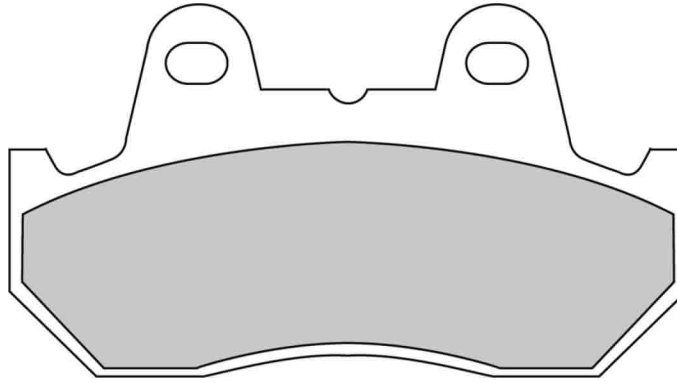

ALSO AVAILABLE		
SHAPE	TH. MM	NOTES
FDB538	9.0	
FDB665	11.0	

CROSS REFERENCE	
BRAKING	654
BREMBO	07HO10
CL BRAKES	2382
CL BRAKES	3011
COBREQ	N-911
EBC	FA069
FRAS-LE	PD/856
GALFER	FD054
GOLD FREN	050
LUCAS/TRW	MCB512
NEWFREN	FD0054
SBS	542
VESRAH	VD-123

		CC	KW	FROM		TO	FRONT		LEFT
				REAR	RIGHT		REAR	RIGHT	
	HONDA								
M	CB 125 TDC - TDE - TDJ	125		1983	1989		F		
S	CN 250 HELIX-FUSION	250		1986	1987		F		
M	NS 250 RF	250		1984	1986		F		
M	NS 250 RF	250		1984	1986		R		
M	NSR 250	250		1986			R		
M	NSR 250 R	250		1986	1987		R		
M	CBR 400 RH-YA (NC23) 101	400		1986	1986		R		
M	CBR 400 RG (NC23) 100	400		1986	1986		R		
M	CBX 400 C	400		1983			R		
M	FT 400	400		1982			F		
M	FT 400	400		1982			R		
M	NS 400 RF - RG	400		1985			R		
M	NV 400 SP CUSTOM	400		1988			R		
M	VF 400 F INTEGRA	400		1982			R		
M	VFR 400 R	400		1986	1987		R		
M	CMX 450 CG REBEL	450		1986	1988		F		
M	CX 500 CC - EC	500		1982			F		
M	CX 500 CC - EC	500		1982			R		
M	CX 500 T (TURBO)	500		1983			F		
M	CX 500 T (TURBO)	500		1983			R		
M	FT 500 - C	500		1982			F		
M	FT 500 - C	500		1982			R		
M	GL 500 SILVER WING INTERSTATE	500		1982			F		
M	GL 500 DC	500		1982			F		
M	VF 500 FE - F2E	500		1984			F		
M	VF 500 FF - F2F	500		1984			F		
M	VT 500 CD - FT	500		1982			F		

		CC	KW	FROM		TO	FRONT		LEFT
				REAR	RIGHT		REAR	RIGHT	
									
M	XBR 500 S - F - G - H	500		1985			F		
M	XL 600 LM	600		1985	1990		F		
M	XL 600 RM	600		1986	1990		F		
M	XL 600 V TRANSALP	600		1987	1990		F		
M	CB 650 SCD	650		1983			F		
M	CBX 650 ED	650		1983			F		
M	CX 650 ED	650		1982			F		
M	CX 650 TD (TURBO) E	650		1983			F		
M	CX 650 TD (TURBO) E	650		1983			R		
M	CX 650 EC - T	650		1983			F		
M	CX 650 EC - T	650		1983			R		
M	GL 650 D2TE	650		1983			F		
M	GL 650 DD - ID	650		1983			F		
M	CB 700 SC NIGHT HAWK	700		1984			F		
M	VF 700 C MAGNA	700		1984			F		
M	VF 700 S SABRE	700		1984			F		
M	VF 700 F INTERCEPTOR	700		1984	1985		F		
M	VF 700 C MAGNA	700		1985			F		
M	VT 700 C SHADOW	700		1986			F		
M	VT 700 C SHADOW	700		1987			F		
M	B 750 EC - ED	750		1982			F		
M	B 750 EC - ED	750		1982			R		
M	B 750 F2 - F2D	750		1982			F		
M	B 750 F2 - F2D	750		1982			R		
M	CB 750 SC NIGHTHAWK	750		1982	1983		F		
M	CB 750 K	750		1982			F		
M	CB 750 K	750		1982			R		

M = MOTORCYCLE
S = SCOOTER
A = ATV
Sn = SNOWMOBILE

		CC	KW	FROM	TO	FRONT / REAR	LEFT / RIGHT
							
M	CBX 750 FE	750		1983	1984	F	
M	VF 750 F-FD-FE-MAGNA-SABRE-INT	750		1982		F	
M	VF 750 C-SC-CC-F-FC	750		1983		F	
M	VT 750 C SHADOW	750		1983	1985	F	
M	VT 750 C SHADOW	750		1986	1986	F	
M	XLV 750 R - RD - RF	750		1984	1988	F	
M	VT 800 C	800		1988		F	
M	CB 900 F2B - FB	900		1982	1983	F	
M	CB 900 F2B - FB	900		1982	1983	R	
M	CB 900 FD - FC - F2C - F2D	900		1983	1985	F	
M	CB 900 FD - FC - F2C - F2D	900		1983	1985	R	
M	CBX 1000 B - C	1000		1981	1982	F	
M	CBX 1000 B - C	1000		1981	1982	R	
M	VF 1000 BOL D'OR	1000		1984	1986	F	
M	VF 1000 - 2	1000		1984	1986	F	
M	VF 1000 F - FE	1000		1984	1986	F	
M	VF 1000 RE - RF	1000		1984	1986	F	
M	CB 1100 FD	1100		1980	1983	F	

		CC	KW	FROM	TO	FRONT / REAR	LEFT / RIGHT
							
M	CB 1100 FD	1100		1980	1983	R	
M	CB 1100 RCII	1100		1980	1983	F	
M	CB 1100 RCII	1100		1980	1983	R	
M	CB 1100 RBI - II	1100		1980	1983	F	
M	CB 1100 RBI - II	1100		1980	1983	R	
M	CBX 1100 F	1100		1982	1985	R	
M	GL 1100 / DX	1100		1982		F	
M	GL 1100 / DX	1100		1982		R	
M	VT 1100 C MAGNA	1100		1983	1985	F	
M	VT 1100 C MAGNA	1100		1983	1985	R	
M	VT 1100 C	1100		1985	1993	F	
M	GL 1200 DX all models	1200		1984	1986	F	
M	GL 1200 DX all models	1200		1984	1986	R	
M	GL 1520	1500		1988	1989	R	
M	GL 1500 GOLD-ASPENCADE	1500		1992		R	
M	GL 1500 SE GOLD WING	1500		1993	2000	R	
KAWASAKI	M	VT 800 C	800		1988	1990	F

FDB247

95.0 x 56.0 x 12.0 mm

Minimum thickness 7,5 mm

MATERIAL AVAILABILITY

AG	EF	P	PRP	ST	SM	SG	ZR	XRAC	ZRAC	CP1	CPRO
		✓									

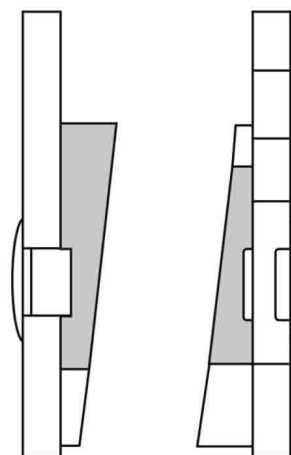
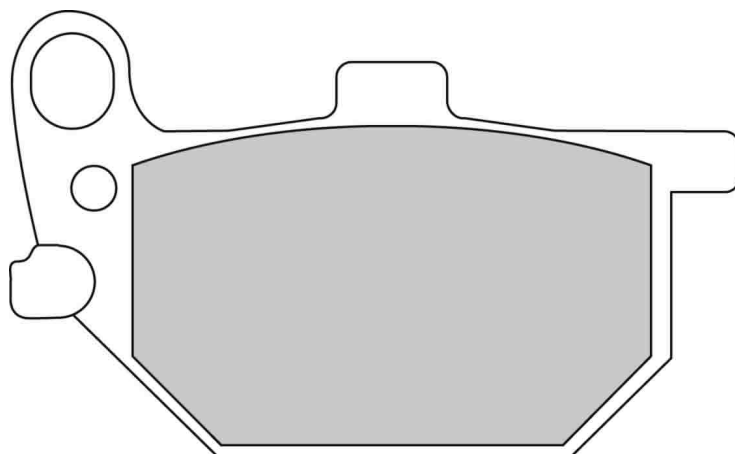

CROSS REFERENCE

BREMBO	07YA04
EBC	FA061
GALFER	FD077
NEWFREN	FD0066
SBS	545
VESRAH	VD-216

		CC	KW	FROM	TO	FRONT / REAR	LEFT / RIGHT
							
YAMAHA	M	XS 750 SE - SG	750		1979	1980	F
	M	XV 750 SE	750		1981		F

		CC	KW	FROM	TO	FRONT / REAR	LEFT / RIGHT
							
	M	XS 850	850		1980	1982	F left

FDB250

40.0 x 45.0 x 7.3 mm

June 2017: AG superseded by EF

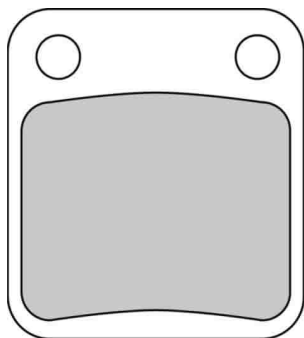

MATERIAL AVAILABILITY											
AG	EF	P	PRP	ST	SM	SG	ZR	XRAC	ZRAC	CP1	CPR0
X	✓	✓				✓					

Pinze / Calipers

WILWOOD

GP 200 Calipers

CROSS REFERENCE	
BRAKING	703
BREMBO	07024
BREMBO	07HO09
BREMBO	7024
BRENTA	3083
BRENTA	4083
CL BRAKES	2408
COBREQ	N-906
EBC	FA054
FRAS-LE	PD/850
GALFER	FD095
NEWFREN	FD0080
SBS	100
SBS	536
VESRAH	VD-120

		CC	KW	FROM	TO	FRONT REAR	LEFT RIGHT
AKT	M AK 100 S	100				F	
	M AK 180 XM	180				F	
	M AK 200 XM	200				R	
CAGIVA	M WR 125	125		1993		R	
DAELIM	M "S" FIVE / "E" FIVE	50		2001		F	
	M CORDI 50	50		2004		F	
	M GZ 50 MESSAGE	50		2001	2003	F	
	M TAPO 50	50		1999	2003	F	
	M VIVO 50	50		1999		F	
	M ALTINO 100	100		1999		F	
	M DELFINO 100	100		1999	2000	F	
	M DELFINO 100	100		2001	2003	F	
	M ALTINO 125	125		2001		F	
	M HISTORY 125	125		2001		F	
	M HISTORY 125	125		2001		R	
	M NS 125	125		2001		F	
	M NS 125	125		2001		R	
M OTELLO / NS 125	125		1999		F		
M VS 125	125		1995	1998	F		
HONDA	M CRM 50	50		1988	1992	F	
	M CRM 50	50		1993	1996	F	
	M G-DASH 50	50		1989	1992	F	
	M MB 50	50		1982		F	
	M MXR 50	50				F	
	M CRM 80	80		1988	1992	F	
	M CRM 80	80		1993		F	
	M MBX 80 FWD	80		1983		F	
	M CB 125 RS	125		1983		F	
	M RS 125 R	125		1995	2010	R	
	M RS 250 R	250		1995		R	
	S SILVER WING 600 (FJS)	600		2001	2008	R	
	HONDA 3 WHEELERS	A ATC 250 R	250		1981	1982	F
HUSQVARNA	M 125 ALL MODELS 1992	125		1992	1992	R	
	M 250 ALL MODELS 1992	250		1992	1992	R	
	M TC 610 CROSS	610				R	

		CC	KW	FROM	TO	FRONT REAR	LEFT RIGHT
HYOSUNG ATV	M TE 610	610		1991		R	
	A TE 450 S	450		2007	2010	F	
	A TE 450 S	450		2007	2010	R	
KAWASAKI	M KX 65	65		1999		R	
	M KX 65	65		2000		R	
	M BN 125 A1/A2 ELIMINATOR	125		1998	1999	F	
	M KH 125 K1	125		1982	1998	F	
	M KLX 125 D (D-Tracker)	125		2010		R	
	M KLX 125 C	125		2010		R	
KAWASAKI ATV	A KVF 300 PRAIRIE (2x4/4x4)	300		1999	2002	F	
	A KVF 360 PRAIRIE (All Models)	360		2003	2010	F	
KEEWAY	A Dragon 250 Quad	250		2007	2009	R	
MOTRON	M KCV 50	50				F	
PEUGEOT	S New Vivacity 50cc /2T	50		2008	2012	F	
	S New Vivacity 50cc /4T	50		2008	2012	F	
	S New Vivacity Sixtes 50cc/4T	50		2010	2012	F	
	S Sum-Up (125cc)	125		2008	2011	F	
PGO ATV	A Bugrider 50 (Buggie)	50		2006	2006	R	
	A Bugxter BR150 A	150		2005	2007	R	
QUADZILLA	A BR 200	200		2007	2008	R	
SINNIS	M QM 125 GY-2B (A) Apache 125 (Rear disc model)	125		2009	2010	R	
	M QM 125 GY-2B Blade 125	125		2009	2010	R	
	S QM 125 T- Matrix	125		2010		F	
	S QM 125 T-10H Matrix II	125		2010		F	
	S QM 125 T-10R Eagle 125	125		2010		F	
	S 125 T-8G Ecocity 125	125		2007	2009	F	
SUZUKI	M DR 125 S	125		1986	1993	F	
	M TS 125 X	125		1988		F	
	M TS 125 RK	125		1989		F	
	M TS 125	125		1990	1996	R	
	M TX 125 XF	125		1985		F	
	M DR 200	200		2000		F	
	M DR 200 K	200		1989	1998	F	
	M DR 250 S	250		1986	1989	F	
	M RH 250 X	250		1987		F	

M = MOTORCYCLE
S = SCOOTER
A = ATV
Sn = SNOWMOBILE

		CC	KW	FROM	TO	FRONT / REAR	LEFT / RIGHT
	M	TS 250 X all models	250	1986	1989	F	
SUZUKI ATV	A	LT-F 250 K OZARK	250	2002	2007	F	
	A	LT-A/F 400 EIGER (All models)	400	2002	2008	F	
	A	LT-A/F 500 FK VINSON 4WD	500	2002	2002	F	
SYM ATV	A	LT-A/F 500 FK VINSON 4WD	500	2003	2007	F	
	A	Quadlander 600	600	2008	2010	F	
UM ATV	A	Quadraider 600	600	2006	2007	F	
	A	MTX 450	450	2008		F	
YAMAHA ATV	A	MTX 450	450	2008		R	
	A	YFS 200 BLASTER	200	2003	2006	F	
	A	YFM 250 BRUIN	250	2005	2006	F	
	A	YFM 250 Big Bear	250	2007	2009	F	
	A	YFM 350 XT/XU WARRIOR	350	1987	1988	R	
	A	YFM 350 XW-XS WARRIOR	350	1989	2004	F	
	A	YFM 350 FX WOLVERINE	350	1995	2007	F	

		CC	KW	FROM	TO	FRONT / REAR	LEFT / RIGHT
	A	YFM 350 FW 4WD BIG BEAR	350	1999	2003	F	
	A	YFM 350 BRUIN (All Models)	350	2004	2006	F	
	A	YFM 350 X Wolverine	350	2006	2009	F	
	A	YFM 350 4x4 Grizzly	350	2007	2010	F	
	A	YFM 350 2x4 Grizzly	350	2007	2010	F	
	A	YFZ 350 A/B/D/E/F BANSHEE	350	1990	2006	F	
	A	YFM 400 FW KODIAK	400	1999	2000	F	
	A	YFM 400 BIG BEAR (All Models)	400	2000	2007	F	
	A	YFM 400 FW KODIAK (All Models except AUTO)	400	2000	2006	F	
	A	YFM 400 KODIAK AUTO	400	2003		F	
	A	YFM 400 4x4 Grizzly	400	2007	2008	F	
	A	YFM 450 KODIAK	450	2003	2006	F	
	A	YFM 450 WOLVERINE (All models)	450	2006	2010	F	
	A	YFM 450 Grizzly (All models)	450	2007	2010	F	

FDB277

64.8 x 59.5 x 10.4 mm

MATERIAL AVAILABILITY											
AG	EF	P	PRP	ST	SM	SG	ZR	XRAC	ZRAC	CP1	CPO
		✓									

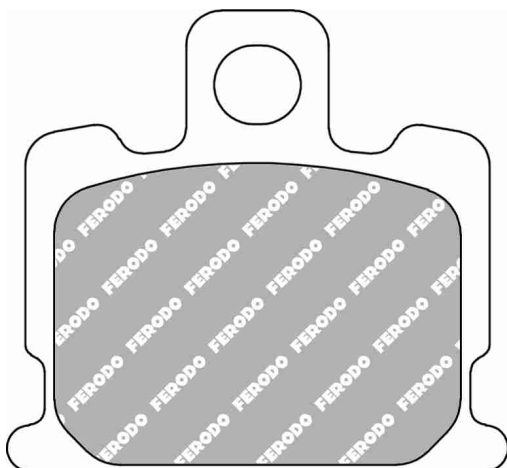

CROSS REFERENCE	
BREMBO	07YA08
CL BRAKES	2807
EBC	FA070
GALFER	FD051
LUCAS/TRW	MCB521
NEWFREN	FD0051
SBS	547
VESRAH	VD-221
VESRAH	VD-228

		CC	KW	FROM	TO	FRONT / REAR	LEFT / RIGHT
YAMAHA	M	RD 50 MX	50	1981	1987	F	
	M	RD 80 MX	80	1981	1982	F	
	M	RD 80 AIR COOLED	80	1981	1982	F	
	M	RX 80 SE	80	1982		F	
	M	RD 250 LC	250	1981	1983	F	

		CC	KW	FROM	TO	FRONT / REAR	LEFT / RIGHT
	M	RD 350 LC	350	1981	1982	F	
	M	XJ 550	550	1981	1984	F	
	M	XJ 750	750	1982	1984	F	
	M	XV 1000 SE MIDNIGHT SPECIAL	1000	1983		F	
	M	XS 1100 S	1100	1981		F	

FDB298

68.0 x 41.0 x 9.6 mm

MATERIAL AVAILABILITY											
AG	EF	P	PRP	ST	SM	SG	ZR	XRAC	ZRAC	CP1	CPRO
		✓									

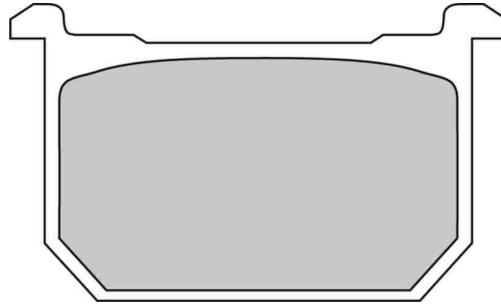

ALSO AVAILABLE		
SHAPE	TH. MM	NOTES
FDB299	8.2	

CROSS REFERENCE	
BRAKING	652
BREMBO	07KA06
EBC	FA068
GALFER	FD052
LUCAS/TRW	MCB516
NEWFREN	FD0053
SBS	540
VESRAH	VD-420/2
VESRAH	VD-421



			CC	KW	FROM	TO	FRONT REAR	LEFT RIGHT
KAWASAKI	M Z 250 A3		250		1981	1983	F	
	M Z 250 J1		250		1981	1983	F	
	M GPZ 400		400		1983	1984	R	
	M Z 400 GP (M1)		400		1983		R	
	M Z 440 C2		440		1981		F	
	M Z 440 D5 LTD		440		1981	1983	F	
	M Z 440 H1 - H2		440		1981	1983	F	
	M Z 550 GP D1 - H1 - H2		550		1981	1983	R	
	M Z 550 GP		550		1984		R	
	M GT 750		750		1985	1996	R	
	M Z 750 SPORT		750		1984		R	
	M Z 750 E1		750		1980		R	
	M Z 750 H1 - H2 LTD		750		1980		R	
	M Z 750 LTD TWIN K1		750		1983		F	



			CC	KW	FROM	TO	FRONT REAR	LEFT RIGHT
	M Z 750 L1 - L3		750		1981		R	
	M Z 750 P1		750		1981		R	
	M Z 750 P2 SHAFT		750		1981		R	
	M Z 750 P2 SHAFT GT		750		1981		R	
	M Z 750 GP R1		750		1982		R	
	M KZ 1000 all models		1000		1982	1990	F	
	M KZ 1000 all models		1000		1982	1990	R	
	M Z 1000 LTD		1000		1981		R	
	M GPZ 1100 (ZX 1100 B1-B2)		1100		1982	1983	F	
	M GPZ 1100 (ZX 1100 B1-B2)		1100		1982	1983	R	
	M Z 1100 A1/3 - B1/2 - F1		1100		1981	1983	R	
	M Z 1100 GP		1100		1981	1983	R	
	M Z 1100 ST		1100		1981	1983	R	

M = MOTORCYCLE
S = SCOOTER
A = ATV
Sn = SNOWMOBILE

FDB299

68.0 x 41.0 x 8.2 mm

MATERIAL AVAILABILITY											
AG	EF	P	PRP	ST	SM	SG	ZR	XRAC	ZRAC	CP1	CPRO
		✓									

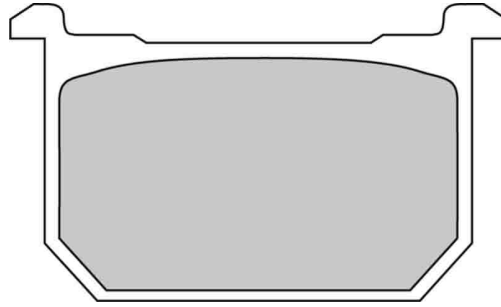

ALSO AVAILABLE		
SHAPE	TH. MM	NOTES
FDB298	9.6	

CROSS REFERENCE	
BREMBO	07KA05
EBC	FA066
EBC	FA068
GALFER	FD052
LUCAS/TRW	MCB515
NEWFREN	FD0052
SBS	539
VESRAH	VD-420
VESRAH	VD-421

		CC	KW	FROM	TO	FRONT / REAR	LEFT / RIGHT
	KAWASAKI						
	M GPZ 400	400		1983	1984	F	
	M Z 400 GP (M1)	400		1983		F	
	M Z 400 J2 - J3	400		1981	1983	F	
	M Z 550 A3 - C1 - C2 LTD	550		1980		F	
	M Z 550 GP D1 - H1 - H2	550		1981	1983	F	
	M Z 550 GP	550		1984		F	
	M Z 650 F2 - F4	650		1980	1983	F	
	M GT 750	750		1985	1996	F	
	M Z 750 SPORT	750		1984		F	
	M Z 750 E1	750		1980		F	
	M Z 750 H1 - H2 LTD	750		1980		F	
	M Z 750 L1 - L3	750		1981		F	

		CC	KW	FROM	TO	FRONT / REAR	LEFT / RIGHT
	M						
	Z 750 P1	750		1981		F	
	Z 750 P2 SHAFT	750		1981		F	
	Z 750 P2 SHAFT GT	750		1981		F	
	Z 750 GP R1	750		1982		F	
	Z 750 Y1 LTD	750		1982		F	
	Z 1000 LTD	1000		1981		F	
	Z 1100 SPECTRE - LTD	1100		1981	1983	F	
	Z 1100 SPECTRE - LTD	1100		1981	1983	R	
	Z 1100 A1/3 - B1/2 - F1	1100		1981	1983	F	
	Z 1100 GP	1100		1981	1983	F	
	Z 1100 ST	1100		1981	1983	F	

FDB310

92.0 x 53.0 x 8.4 mm

MATERIAL AVAILABILITY											
AG	EF	P	PRP	ST	SM	SG	ZR	XRAC	ZRAC	CP1	CPRO
		✓									

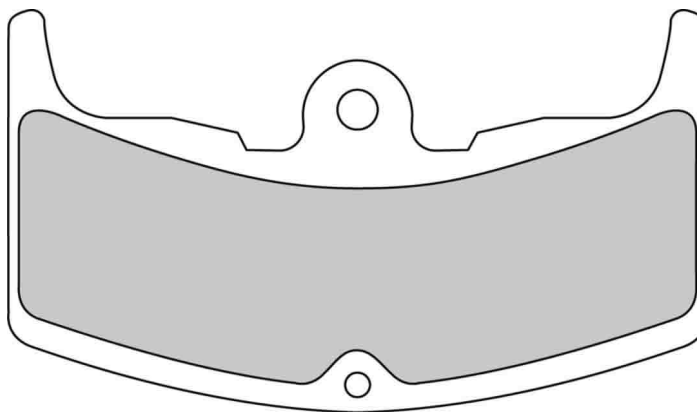

CROSS REFERENCE	
BREMBO	07HO14
BREMBO	07HO17
EBC	FA080/2
GALFER	FD060
LUCAS/TRW	MCB543
NEWFREN	FD0063
SBS	552
SBS	571
VESRAH	VD-129
VESRAH	VD-129/2

		CC	KW	FROM	TO	FRONT REAR	LEFT RIGHT
	HONDA						
	M	MVX 250 F	250	1988		F	
	M	VT 250 Z	250	1982	1987	F	
	M	VT 250 F-II	250	1983	1984	F	
M	VT 500 ED - EF - C	500		1983		F	

		CC	KW	FROM	TO	FRONT REAR	LEFT RIGHT
	HONDA						
	M	CBX 550 FC - FD - F2C - F2D	550	1982	1984	F	
	M	CBX 550 FC - FD - F2C - F2D	550	1982	1984	R	
	M	CB 650	650			F	
M	CB 650	650				R	

M = MOTORCYCLE
S = SCOOTER
A = ATV
Sn = SNOWMOBILE

FDB311

68.1 x 58.7 x 8.4 mm

MATERIAL AVAILABILITY

AG	EF	P	PRP	ST	SM	SG	ZR	XRAC	ZRAC	CP1	CPRO
		✓									

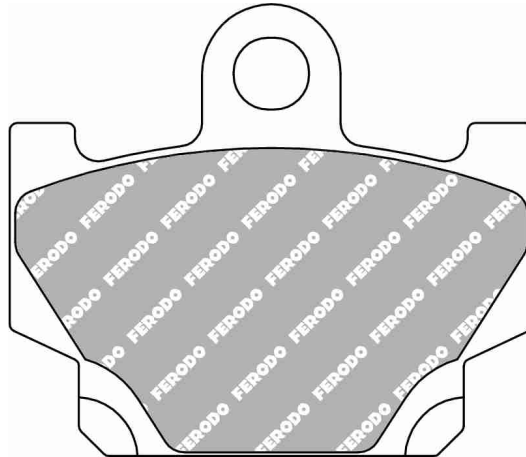

CROSS REFERENCE

BRAKING	658
BREMBO	07YA10
CL BRAKES	2802
COBREQ	N-901
EBC	FA081
FRAS-LE	PD/858
GALFER	FD056
LUCAS/TRW	MCB524
NEWFREN	FD0062
SBS	550
VESRAH	VD-235

		CC	KW	FROM	TO	FRONT REAR	LEFT RIGHT
	YAMAHA						
M	RD 80 LC1	80		1982		F	
M	RD 80 LC2 - LCS	80		1982		F	
M	RD 125 LC	125		1982	1984	F	
M	SR 125	125		1993	1996	F	
M	XV 240 VIRAGO	240		1991	1992	F	
M	XV 240 VIRAGO	240		1992	2000	F	
M	SR 250 E (Espana)	250		1990	1994	F	
M	XV 250 VIRAGO	250		1993	1994	F	
M	RD 350 YPVS	350		1983	1984	F	
M	XT 350 4 VALVES	350		1985		F	

		CC	KW	FROM	TO	FRONT REAR	LEFT RIGHT
							
M	XS 400 SPECIAL	400		1982		F	
M	XS 400 DOHC	400		1982		F	
M	XT 500 (Austria)	500		1983		F	
M	XZ 550	550		1982	1984	F	
M	XZ 550 S	550		1984	1986	F	
M	TT 600 N	600		1985	1988	F	
M	XT 600 4 VALVES	600		1984	1985	F	
M	XT 600 Z TENERE	600		1983	1984	F	
M	XJ 650 TURBO	650		1983		F	

FDB312

76.5 x 42.2 x 6.8 mm

MATERIAL AVAILABILITY											
AG	EF	P	PRP	ST	SM	SG	ZR	XRAC	ZRAC	CP1	CPRO
	✓	✓		✓							

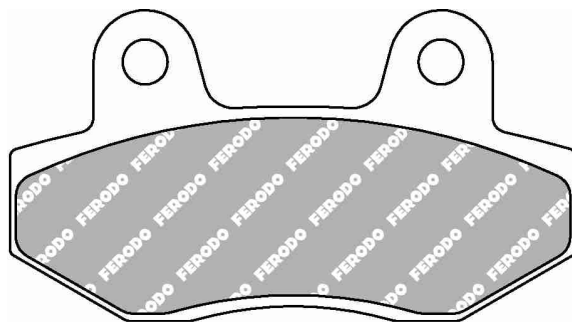

CROSS REFERENCE	
BRAKING	673
BREMBO	07GR12
BREMBO	07HO13
BREMBO	7080
BRENTA	3069
BRENTA	4069
CL BRAKES	2621
EBC	FA086
GALFER	FD073
GOLD FREN	011
LUCAS/TRW	MCB525
LUCAS/TRW	MCB822
NEWFREN	FD0075
SBS	551
SBS	814
VESRAH	VD-131

		CC	KW	FROM	TO	FRONT / REAR	LEFT / RIGHT
AKT	M AK 110	110				F	
	M AK 125 S	125				F	
	M AK 125 SL	125				F	
	M AK 125 TT	125				F	
BETA	M R 150 (Minicross /4T/49cc)	50		2010	2012	F	
CFMOTO	S CF 250 T - 6A (Scooter)	250		2012		F	
DAELIM	M CITY ACE 110	110		2003		F	
HONDA	M MBX 50 SD - SF	50		1983		F	
	M NSR 50 (Spain)	50				F	
	M NSR 50	50		1993	1994	F	
	M NSR 75 (FIJ)	75		1988		F	
	M MBX 80 DX	80		1982		F	
	M MBX 80	80		1982		F	
	M MBX 80 (ESPANA)	80		1984		F	
	M MBX 80 VOLLUERKLEIDUNG	80		1985		F	
	M NSR 80 R	80		1987	1992	F	
	S CH 125 ELITE/SPACY	125		1998		F	
	M FS 125 Sonic	125		2003	2004	F	
	M MBX 125 RWB	125		1984	1986	F	
	M REBEL 250	250		1986		F	
	HYOSUNG	M COMET 125	125		2004		F
M COMET 125		125		2004		R	
M GT 125 Naked		125		2004		F	
M GT 125 Naked		125		2004		R	
M GT 125 R		125		2006		F	
M GT 125 R		125		2006		R	
M GT 125 RC		125		2016		F	
M GT 125 RC		125		2016		R	
M GV 125 AQUILA		125		2001		F	
M GV 125		125		2005		F	
M RT 125 KARION		125		2002	2006	F	
M RT 125 D KARION	125		2007		F		
M RX 125	125		2001	2007	F		
M RX 125 SM	125		2007		F		
M RX 125 SM	125		2007		R		

		CC	KW	FROM	TO	FRONT / REAR	LEFT / RIGHT
M	XRX 125 OFFROAD	125		1999		F	
	GT COMET 250 (Naked)	250		2004	2005	F	
M	GT COMET 250 (Naked)	250		2004	2005	R	
M	GT 250 R (Carbs)	250		2005	2007	F	
M	GT 250 R (Carbs)	250		2005	2007	R	
M	GT 250 (Naked)	250		2006	2012	F	
M	GT 250 (Naked)	250		2006	2012	R	
M	GT 250 R (Inj)	250		2008	2013	F	
M	GT 250 R (Inj)	250		2008	2013	R	
M	GT 250 i (Naked)	250		2013		F	
M	GT 250 R (Inj)	250		2014		F	
M	GT 250 P	250		2015		F	
M	GV 250 AQUILA	250		2004	2007	F	
M	GV 250	250		2008		F	
M	GT 650 COMET (Naked)	650		2004	2008	F	
M	GT 650 COMET (Naked)	650		2004	2008	R	
M	GT 650 S	650		2005	2008	F	
M	GT 650 S	650		2005	2008	R	
M	GT 650 R	650		2007	2008	F	
M	GT 650 R	650		2007	2008	R	
M	GT 650 i R	650		2009	2013	R	
M	GT 650 (Naked)	650		2009	2011	R	
M	GT 650 i (Naked)	650		2012		R	
M	GV 650 AQUILA (Carb)	650		2004	2006	F	
M	GV 650 (EFI)	650		2007	2012	F	
M	GV 650 (EFI)	650		2007	2012	R	
M	GV 650 Progress	650		2012		F	
M	GV 650 Progress	650		2012		R	
M	ST7	678		2010		R	
M	ST7-Deluxe	678		2012		R	
M	GV 700 C	700		2006	2009	F	
M	GV 700 C	700		2006	2009	R	
M	GV 700 AQUILA	700		2010		R	
M	GV 1000	1000		2004		F	
ITALJET	M GRIFON 650	650		2007		F	

M = MOTORCYCLE
S = SCOOTER
A = ATV
Sn = SNOWMOBILE



		CC	KW	FROM	TO	FRONT / RÉAR	LEFT / RIGHT
JONWAY	S	YY 50 QT-6 (2T) Agility	50	2007	2009	F	
	S	YY 50 QT-6 (4T) Agility	50	2007	2009	F	
	S	YY 50 QT-10 (2T) Viper	50	2007	2009	F	
	S	YY 50 QT-10 (4T) Viper	50	2007	2009	F	
	S	YY 50 QT-28 (2T) Raptor	50	2007	2009	F	
	S	YY 50 QT-28 (4T) Raptor	50	2007	2009	F	
	S	YY 80 QT-6 (4T) Agility	80	2007	2009	F	
	S	YY 150 T-19	150	2008	2009	F	
	S	YY 150 T-19	150	2008	2009	R	
	S	YY 250 T-19	250	2008	2009	F	
	S	YY 250 T-19	250	2008	2009	R	
KEEWAY	S	Agora 50 (2T/4T)	50	2010		F	
	S	50 Zahara (2T/4T)	50	2013		F	
	S	110 Kee	110	2012		F	
	S	125 Link	125	2013		F	
	S	125 Link	125	2013		R	
	S	RKS 125	125	2010	2011	F	
	M	125 Strike	125	2013		F	
	S	125 Zahara (2T/4T)	125	2013		F	
	S	150 Link	150	2013		F	
	S	150 Link	150	2013		R	
	M	150 Strike	150	2013		F	
	S	200 Link	200	2013		F	
	S	200 Link	200	2013		R	
KSR MOTO BY GENERIC	S	Vertigo 125	125	2013		F	
KYMCO	S	ACTIV 50 SR	50	2008	2011	F	
	S	JETIX 50	50	2010	2010	F	



		CC	KW	FROM	TO	FRONT / RÉAR	LEFT / RIGHT
	S	NEXXON 50	50	2008	2009	F	
	S	NEXXON 50	50	2008	2009	R	
	S	JETIX 125	125	2010	2010	F	
	S	NEXXON 125	125	2007	2008	F	
	S	NEXXON 125	125	2007	2008	R	
	M	PULSAR 125	125	1999	2013	F	
	M	STRAIGHT 150	150	2008		F	
	M	STRAIGHT 150	150	2008		R	
LAMBRETTA	S	50 N Pato	50	2008	2010	F	
	S	50 N Pato	50	2008	2010	R	
	S	125 N Pato	125	2008	2010	F	
	S	125 N Pato	125	2008	2010	R	
	S	151 N Pato	150	2008	2010	F	
	S	151 N Pato	150	2008	2010	R	
PEUGEOT	S	Speedfight 3 - RS (50cc L/C - 2T)	50	2009	2012	F	
	S	Speedfight 3 (50cc A/C - 2T)	50	2009	2012	F	
	S	Speedfight 3 (50cc L/C - 2T)	50	2009	2012	F	
	S	Speedfight 3 - RS (50cc - A/C - 2T)	50	2010	2012	F	
	S	Speedfight 4 LC (50cc 2T)	50	2015		F	
	S	Speedfight 4 LC (50cc 4T)	50	2015		F	
	S	Speedfight 4 AC (50cc 2T)	50	2015		F	
	S	Speedfight 4 AC (50cc 4T)	50	2015		F	
	S	Speedfight 125	125	2013		F	
SINNIS	S	Nitro 50 (2T)	50	2009	2010	F	
	S	Strike 50 (2T)	50	2009	2010	F	
	S	WY 125 T-56A Nitro 125	125	2009	2010	F	

FDB313

85.0 x 43.0 x 6.9 mm / 48.0 x 37.0 x 9.1 mm

March 2018: AG superseded by EF

MATERIAL AVAILABILITY											
AG	EF	P	PRP	ST	SM	SG	ZR	XRAC	ZRAC	CP1	CPR0
✗	✓	✓				✓					

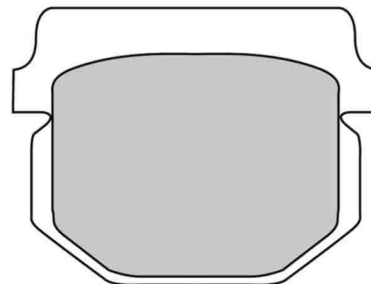
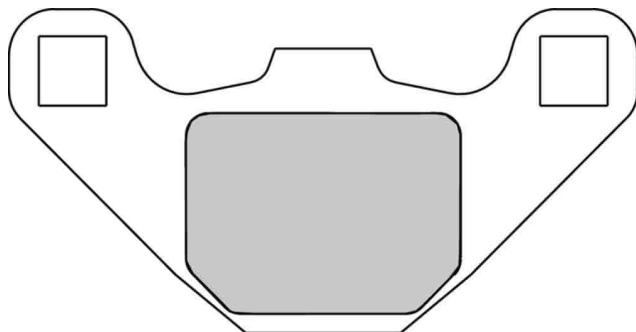

CROSS REFERENCE	
BRAKING	702
BREMBO	07HO11
BREMBO	07KA07
BRENTA	3074
BRENTA	3075
BRENTA	4074
BRENTA	4075
CL BRAKES	2469
CL BRAKES	3022
CL BRAKES	3023
EBC	FA083
GALFER	FD094
GOLD FREN	042
GOLD FREN	047
LUCAS/TRW	MCB519
LUCAS/TRW	MCB522
NEWFREN	FD0085
SBS	101
SBS	102
SBS	544
VESRAH	VD-342

		CC	KW	FROM	TO	FRONT REAR	LEFT RIGHT
	ADLY	S Cat 50	50	1998		F	
		S G-Shock 50	50	1998		F	
		S Super Sonic 50	50	2000		F	
		S Thunderbike 50	50	1997		F	
		S Cat 100	100	1998		F	
		S G-Shock 100	100	1998		F	
		S Cat 125	125	1998		F	
	ADLY ATV	A Interceptor 300	300	2006		F	
		A Interceptor 300	300	2006		R	
		A 300 Utility	300	2006		F	
		A 300 Utility	300	2006		R	
	APRILIA	M RS4 50 (JJ caliper)	50	2011		R	
		M SX 50 Ltd.	50	2014		R	
		M RS	125	2017		R	
		M RS4 125 4T (JJ caliper)	125	2011		R	
		M RS4 125 4T SBK Replica (JJ caliper)	125	2015		R	
		M RX 125	125	2019		R	
		M SX 125	125	2018		R	
		M TUONO 125 4T	125	2017		R	
	BOMBARDIER ATV	A RALLY 200	200	2003	2007	F	
	CAN AM ATV	A DS 90 X (2x4/4T)	90	2008	2010	F	
		A DS 90 X (2x4/4T)	90	2008	2010	R	
		A Rally 200	200	2007		F	
	CPI	M HUSSAR 50	50	2001	2002	F	
	DINLI ATV	A Diamond Back 90	90	2006		R	
	E-TON ATV	A BXL-50 Draco	50	2005	2006	R	
		A Viper 50 Mini RXL 50 M (4T)	50	2003	2007	R	

		CC	KW	FROM	TO	FRONT REAR	LEFT RIGHT
	A Viper 50 RXL 50	50		2003	2007	R	
	A Viper 70 RLX 70/70M (2T/4T)	70		2005	2009	R	
	A RXL 90 Viper 90	90		2003	2006	R	
	A RXL 90 R Viper 90 R Reverse (2T/4T)	90		2003	2009	R	
	A BXL 100 Draco	100		2005	2006	R	
	A Yukon ELX 150	150		2005	2006	F	
	A Viper EXL 150 ST Quad	150		2005	2006	F	
	A Vector VXL 250 ST Quad	250		2006	2009	F	
	A Vector VXL 250 ST Quad	250		2006	2009	R	
	HONDA	M MB 80	80	1980		F	
	M MCX 80 all models	80		1982	1984	F	
	HYOSUNG	M AVANTI 50	50	1999		F	
	M RUSH 50	50		1997		F	
	M SENSE 50	50		1998		F	
	M SF 50 / RALLY / RACING	50		1999		F	
	M SUPER CAB 50	50		1995	1997	F	
	M SUPER CAB 50 PLUS	50		1998		F	
	M CAB 100	100		1998		F	
	M KR 110 MASTER	110		2004		F	
	M MIDAS 110 PLUS	110		1998		F	
	M KE 125-2	125		2016		F	
	KAWASAKI	M AR 50	50	1981	1995	F	
	M KMX 50	50		1988		F	
	M KSR 50 I/II	50		1990	1991	F	
	M AR 80	80		1981	1982	F	
	M KD 80	80		1988	1990	F	
	M KX 80 E2	80		1984	1986	F	

M = MOTORCYCLE
S = SCOOTER
A = ATV
Sn = SNOWMOBILE



		CC	KW	FROM	TO	FRONT / REAR	LEFT / RIGHT
	M KX 80 R3	80		1993	1996	F	
	M KX 80 S1 - V1	80		1988	1991	F	
	M KX 100	100		1988	1991	F	
	M KDX 125 A1	125		1990	1994	F	
	M KMX 125	125		1986	1998	F	
	M KX 125 B1	125		1981	1981	F	
	M KMX 200	200		1988	1992	F	
	M KX 250 B1	250		1982	1982	F	
KAWASAKI 3 WHEELERS	A KXT 250 TECATE	250		1984	2000	R	
KAWASAKI ATV	A KXF 250 Tecate	250		1989		R	
KEEWAY	S F-Act 50 EVO (2T)	50		2009		R	
	S Flash 50	50		2007	2009	F	
	S Hurricane 50	50		2007		F	
	S Hurricane 50-Base	50		2007		F	
	S Pixel 50	50		2008	2012	F	
	S Matrix 125	125		2006	2007	F	
	A Dragon 250 Quad	250		2007	2009	F	
	S 350i Index	350		2013		R	
KSR MOTO BY GENERIC	S Jump 50 (2T)	50		2012		F	
MALAGUTI	M CENTRO 50 4T / SL 4T	50		2008		F	
PEUGEOT	M BUXI RS 50	50		1994	1997	F	
	S Kisbee 50 (4T)	50		2010	2012	F	
	S Kisbee RS 50 (4T)	50		2010	2012	F	
	S Kisbee 50 (2T)	50		2010	2012	F	
	S Kisbee RS 50 (2T)	50		2010	2012	F	
	M SPEEDFIGHT 50 M (Heng-Tong caliper)	50		1997		F	
	M SQUAB 50 (Heng-Tong caliper)	50		1996	2001	F	
	M TREKKER 50 ROAD	50		1997		F	
	S Vivacity 2 50	50		2008	2011	F	
	S Kisbee 100 (K3)	100		2013		F	
	S Metropolis RS Parking Brake	400		2014		R	
	S Metropolis SPORT Parking Brake	400		2014		R	
	S Metropolis GT Connect Parking Brake	400		2015		R	
PGO	M COMET 50	50		1991		F	
	M GALAXI 50	50		1992		F	
	S Mega 50	50		1994		F	
	M PS 50	50		1993		F	
	M GALAXI 90	90		1992		F	
PGO ATV	A X Rider 50	50		2004	2005	R	
	A XL-Rider 50	50		2007	2008	R	
	A X Rider 90	90		2004	2005	R	
	A X Rider 110	110		2004	2005	R	
	A X Rider 150	150		2004	2005	R	
PIAGGIO	M NRG 50 POWER DT	50		2005	2007	F	
	M NRG 50 POWER DD / Silver Bullet	50		2005		F	
	M NRG 50 Power Pure Jet	50		2004	2010	F	
	M NRG 50 Power DD	50		2005	2013	F	
	M NRG 50 Power DT	50		2005	2013	F	
	M NRG 50 Silver Bullet	50		2010	2010	F	
POLARIS ATV	A PHOENIX 200 (Rear drum model)	200		2005	2010	F	
	A Phoenix 200 (Rear disc model)	200		2005	2008	F	
	A Phoenix 200 (Rear disc model)	200		2005	2008	R	
	A SAWTOOTH 200 (Rear drum model)	200		2006		F	
	A Sawtooth 200 (Rear disc model)	200		2006		F	
	A Sawtooth 200 (Rear disc model)	200		2006		R	
QUADRO	S 350 D	350		2011	2015	R	
	S 350 S	350		2013	2015	R	
	S 350 4	350		2014	2015	R	
QUADZILLA	A ZR 50	50		2007	2009	R	
SHERCO	M 50 SE-R	50		2014		F	
	M 50 SE-R	50		2014		R	
	M 50 SM-R	50		2014		F	
	M 50 SM-R	50		2014		R	



		CC	KW	FROM	TO	FRONT / REAR	LEFT / RIGHT
	M X-Ride125	125		2012		F	
	M X-Ride125	125		2012		R	
	M X-Ride 290	290		2012		F	
	M X-Ride 290	290		2012		R	
SUZUKI	M ADDRESS 50	50		1992	1995	F	
	M SEPIA 50	50		1992	1995	F	
	M SEPIA AU 50 ZZ	50		1996	1998	F	
	M TUNE 50	50		1993	1995	F	
	M ZZ 50	50		1992	1995	F	
	M LIDO 75	75		1989		F	
	M AH 80	80		1992	1994	F	
	M RM 80 X	80		1986	1989	F	
	M RM 80 L/M	80		1990	1994	F	
	M RM 80 L/M	80		1990	1994	R	
	M RM 80 XT- XV - X	80		1996	2001	R	
	M RM 85 L	85		2002	2004	R	
	M ADDRESS 100 V	100		1992	1996	F	
	M LIDO 125 VARIO	125		1990	1993	F	
	M GV 1400	1400		1985	1986	R	
TGB	M 203 TRIGGER 50	50		2002		F	
	S 303Revolution (50cc)	50		2002	2003	F	
	S 303RHawk/Laser (50cc)	50		2004		F	
	S F409Cruise 50/125	50		2002	2005	F	
	S R50 X Bullet	50		2006	2010	R	
	S R50 X Bullet	50		2010		R	
	S Bullet 2 50 (2T)	50		2011	2012	F	
	S Bullet 50 RR (2T)	50		2011	2012	F	
	S Bullet 50 RR (2T)	50		2011	2012	R	
	S Bullet 50 RS (2T)	50		2011	2012	F	
	S Bullet 50 RS (2T)	50		2011	2012	R	
	S City50cc (2T)	50		2007	2008	F	
	S City50cc (4T)	50		2007	2011	F	
	S Delivery/Express50 (From F/E No 609100)	50		2006	2012	F	
	S HighWheel 50	50		2002	2003	F	
	S TapoRR 50 (2T)	50		2010	2012	F	
	S TapoRS 50 (2T)	50		2010	2012	F	
	S Trigger50	50		2002	2003	F	
	S XRace 50 (2T)	50		2011	2012	F	
	S 204Classic (125cc)	125		2003	2004	F	
	S 303Revolution (125cc)	125		2002	2003	F	
	S F409Cruise 125	125		2002	2005	F	
	S R125 X Bullet	125		2008	2009	R	
	S R125 X Bullet	125		2010		R	
TGB ATV	A Hornet 50 Quad	50		2004	2005	R	
	A Hornet 90 Quad	90		2004	2005	R	
	A 250Blade/Congo ATV	250		2006	2007	R	
	A Blade325 Quad (4x2)	325		2007	2011	F	
	A Blade325 LE Quad (4x2)	325		2008	2010	F	
	A Blade325 SL Quad (4x2)	325		2011	2012	F	
	A Target325 (4X2)	325		2009	2012	F	
	A Target400 (4X2)	400		2009	2010	F	
	A Target425 (4X4)	425		2009	2011	F	
	A Blade460 R Target	460		2012		F	
	A Target500 (4X2)	500		2009	2010	F	
	A Target525 (4X4)	525		2009	2011	F	
TM	M 80 Minicross/Junior	80		1996	2000	F	
	M 85 Minicross/Junior	85		1996	2000	F	
UM ATV	A Moontrax 50 R	50		2003	2006	R	
	A Earthlander 90 R	90		2005	2006	R	
	A Moontrax 90 R	90		2003	2006	R	
	A Earthlander 200	200		2005	2006	R	
YAMAHA ATV	A YFM 90 R Raptor (No Rear Parking Brake)	90		2009	2009	R	

FDB314

85.0 x 43.0 x 7.7 mm / 56.0 x 37.0 x 10.0 mm

MATERIAL AVAILABILITY

AG	EF	P	PRP	ST	SM	SG	ZR	XRAC	ZRAC	CP1	CPR0
	✓	✓		✓		✓					

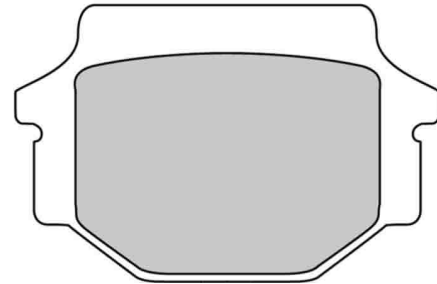
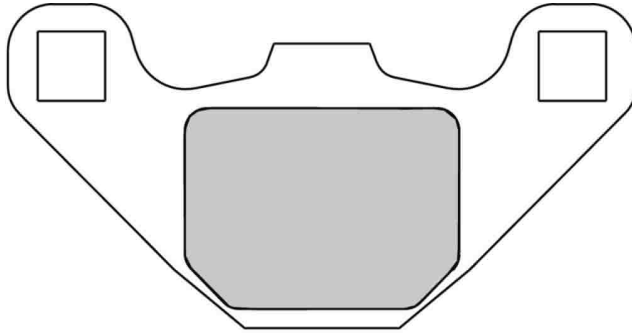

CROSS REFERENCE

BRAKING	669
BREMBO	07BB07
BREMBO	07KS04
BRENTA	3095
BRENTA	4095
CL BRAKES	2306
EBC	FA067
EBC	FA251
GALFER	FD075
GOLD FREN	005
LUCAS/TRW	MCB523
LUCAS/TRW	MCB555
NEWFREN	FD0073
SBS	546
SBS	586
SBS	692
VESRAH	VD-425

		CC	KW	FROM	TO	FRONT REAR	LEFT RIGHT
ALFER	M AR 250	250		1992	1992	R	
	M AR 250	250		1993		R	
	M VR 250	250		1994		R	
APRILIA	M RX 125 (Brembo Front & Grimeca Rear)	125		2008	2013	R	
	M TUAREG 350 WIND	350		1989		R	
	M TUAREG 350 WIND	350		1990		R	
	M TUAREG 600 WIND (Twin discs)	600	34	1988	1990	F	
M TUAREG 600 WIND (Twin discs)	600	34	1988	1990	R		
BUPELL	M M2 Cyclone, S1 Lightning, S2-S3 Thunderbolt	1200		1994	1997	R	
GASGAS	M ENDURCROSS 80	80		1994		R	
	M ENDURCROSS 125	125		1994		R	
	M CROSS 250	250		1995		R	
HUSABERG	M MC 350	350		1991	1993	R	
	M 500 all models	500		1991	1992	R	
	M 500 all models	500		1993	1995	R	
	M 501 ENDURO	500		1992	1993	R	
	M EF 600 E (Quad)	600		1998		R	
	M 600 ENDURO	600		1992	1993	R	
HUSQVARNA	M CR 125 CROSS	125		1991	1995	R	
	M WR 125	125		1991	1997	R	
	M WR 240	240		1991		R	
	M CR 250 CROSS	250		1991	1995	R	
	M WR 250	250		1990	1991	R	
	M WR 260	260		1991		R	
	M TE 350	350		1990	1995	R	
	M TE 510	510		1988	1990	R	
KAWASAKI	M KSR 50 I/II	50		1990	1991	R	
	M KX 80 H - K2	80		1987	1987	F	
	M KX 80 S1 - V1	80		1992		R	
	M KH 100 G4	100		1983		F	
	M AR 125 A1 - LC	125		1982	1994	F	
	M KH 125 EX	125		1982	1983	F	
	M KH 125 K2-4 - L1	125		1982	1983	F	
	M KMX 125	125		1986	1998	R	

		CC	KW	FROM	TO	FRONT REAR	LEFT RIGHT
M KMX 125		125		1999	2003	R	
M KX 125 B2 - C1		125		1982	1985	F	
M KX 125		125		1986	1986	F	
M KX 125		125		1986	1986	R	
M KX 125 E2 - D1 - E2		125		1987	1988	R	
M KDX 200 C1		200		1986	1988	F	
M KDX 200 E1		200		1989		F	
M KMX 200		200		1988	1992	R	
M Z 200 A6		200		1983		F	
M BJ 250 B1-B7A Estrella		250		1992	1999	F	
M BJ 250 B1-B7A Estrella		250		1992	1999	R	
M BJ 250 C1-C7 Estrella-RS		250		1999	2002	F	
M BJ 250 C1-C7 Estrella-RS		250		1999	2002	R	
M EX 250 H1 - H2		250		1990		R	
M GPZ 250		250		1985		F	
M KDX 250 BALIUS		250		1991	1993	R	
M KL 250 SUPER SHERPA		250		2000		R	
M KLE 250 ANHELO		250		1993	1999	R	
M KLR 250 all models		250		1984	2000	F	
M KLX 250 H1 SUPER SHERPA		250		1998	1998	R	
M KMX 250		250		1989		F	
M KMX 250		250		1989		R	
M KX 250 C1 - C2		250		1983	1985	F	
M KX 250		250		1986	1986	F	
M KX 250		250		1986	1986	R	
M KX 250 E1 - F1		250		1987	1988	R	
M ZXR 250		250		1989		R	
M ZZR 250 (EX 250 H)		250		1990	1993	R	
M GPZ 305 A1		305		1983	1996	F	
M GPZ 305 BELT DRIVE		305		1983	1996	F	
M GPZ 305 B2 - B3		305		1983	1996	F	
M EX 4 400		400		1995		R	
S GPX 400		400		1985		F	
M GPZ 400		400		1985	1987	F	

M = MOTORCYCLE
S = SCOOTER
A = ATV
Sn = SNOWMOBILE



		CC	KW	FROM	TO	FRONT / REAR	LEFT / RIGHT
	M KLE 400	400		1991		R	
	M LX 400 ELIMINATOR - SE	400		1990		F	
	M XANTUS 400	400		1992		R	
	M Z 400 F2	400		1985	1987	F	
	M ZR 400 A1 - F	400		1983		F	
	M ZX 400 C2	400		1985		F	
	M GPZ 500 S	500		1988		F	
	M GPZ 500 S	500		1989	1992	F	
	M GPZ 500 S	500		1994	1997	R	
	M KLE 500	500		1991		R	
	M KX 500	500		1986		F	
	M KX 500	500		1986		R	
	M KX 500 A1 - A2	500		1983	1985	F	
	M KX 500 C1	500		1987	1988	R	
	M Z 500 F	500		1983		F	
	M ZR 500 A1	500		1983		F	
	M Z 550 F	550		1983	1984	F	
	M Z 550 GT - SPORT	550		1983		F	
	M Z 550 G1 SHAFT	550		1983		F	
	M ZR 550 A1	550		1983	1984	F	
	S KLR 570	570		1988		F	
	M KLE 600	600		1992		R	
	M KLR 600	600		1984	1988	F	
	M KLR 600 ELECTRIC STARTER	600		1985		F	
	M KLR 600 S	600		1992		F	
	M KL 650 TENGAI	650		1989	1992	R	
	M KLR 650	650		1987	1994	R	
	M KLR 650	650		1995	2005	R	
KAWASAKI 3 WHEELERS	A KXT 250 A2 / B1 TECATE	250		1985	1986	F	
	A KXT 250 A2 / B1 TECATE	250		1985	1986	R	
	A KXT 250 B2 TECATE	250		1987	2000	F	
KAWASAKI ATV	A KLF 300 BAYOU B Series	300		1988	2004	F	
KTM	M 125	125		1989	1990	F	
	M 125	125		1989	1990	R	
	M 250	250		1989	1990	F	
	M 250	250		1989	1990	R	
	M 350	350		1989	1990	F	
	M 350	350		1989	1990	R	
	M GS 350 4 STROKE	350		1993		R	
	M THE DUKE 400	400		1994	1998	R	
	M 500	500		1989	1990	F	
	M 500	500		1989	1990	R	
	M MX 600	600		1992		R	
KYMCO	S VISA R	50		2011	2012	F	
	S VISA R 110	110		2011	2011	F	
	S AGILITY CITY 125 R16	125	7	2008		R	
	S AGILITY CITY E4	125		2008		R	
PEUGEOT	S City Star 125 Blue Line (AC/Carb)	125		2015		R	
	S DJANGO 125 (ALLURE)	125		2014		R	
	S DJANGO 125 (SPORT)	125		2014		R	
	S DJANGO 125 (EVASION)	125		2014		R	
	S DJANGO 150 (ALLURE)	150		2014		R	
	S DJANGO 150 (SPORT)	150		2014		R	
	S DJANGO 150 (EVASION)	150		2014		R	
QUADZILLA	A 300 e XLC Stinger	300		2007	2008	F	



		CC	KW	FROM	TO	FRONT / REAR	LEFT / RIGHT
	A 300 e XLC Stinger	300		2007	2008	R	
	A 300 e XLC	300		2007	2008	F	
	A 300 e XLC	300		2007	2008	R	
	A 300 E Stinger	300		2009	2011	F	
	A 300 E Stinger	300		2009	2011	R	
	A Jow 300	300		2007	2008	F	
	A Jow 300	300		2007	2008	R	
	A RL 300 Buggie	300		2009	2011	F	
	A RL 300 Buggie	300		2009	2011	R	
	A QZ 450 Sport	450		2008	2009	F	
	A QZ 450 Sport	450		2008	2009	R	
	A XLC 500	500		2010	2011	F	
	A XLC 500	500		2010	2011	R	
	A RS 7 4WD	700		2010	2011	R	
	A X7 R	700		2010	2011	R	
	A RS 8	800		2010	2011	R	
SUZUKI	M OR 50	50		1980		F	
	M ZR 50 SKX - SLKX	50		1981	1987	F	
	M 3 E 80	80				F	
	M GT 80 L	80		1981		F	
	M RG 80 GAMMA	80			1987	F	
	M GP 100 C - DEN - N - X	100		1978	1987	F	
	M GN 125 R	125		1994	2001	F	
	M GS 125 ESZ	125		1982		F	
	M GS 125 ESR / ESX	125		1995	2000	F	
	M RG 125 E	125		1982	1984	F	
	M X4 125	125				F	
	M GSX 400 FD	400		1981	1983	F	
	M GSX 400 F (FOUR) FZ	400		1981	1983	F	
	M GS 450 S	450		1987		F	
TGB ATV	A 250Blade/Congo ATV	250		2006	2007	F	
	A Blade325 Quad (4x2)	325		2007	2011	R	
	A Blade325 LE Quad (4x2)	325		2008	2010	R	
	A Blade325 SL Quad (4x2)	325		2011	2012	R	
	A Target325 (4X2)	325		2009	2012	R	
	A Target400 (4X2)	400		2009	2010	R	
	A Target425 (4X4)	425		2009	2011	R	
	A Blade450 SE (4x4)	450		2010	2011	R	
	A Blade460 R Target	460		2012		R	
	A Blade460 SL IRS 4x4	460		2012		R	
	A Target500 (4X2)	500		2009	2010	R	
	A Blade510 LE	510		2011	2012	R	
	A 525SE 4X4	525		2009		R	
	A Blade525 SL 4X4	525		2009	2010	R	
	A Target525 (4X4)	525		2009	2011	R	
	A Blade550 SE 4X4	550		2009	2011	R	
	A Blade550 SL 4X4	550		2009	2010	R	
	A 550IRS Blade LT	550		2010	2012	R	
	A Blade550 LT 4X4	550		2010	2011	R	
	A Blade550 IRS Target	550		2011	2012	R	
TM	M all models 80	80		1990	1993	R	
	M GS / MC 125	125		1990	1993	R	
YAMAHA	M TDR 125 (Italia)	125		1990	1991	R	
YAMAHA ATV	A YFM 90 R Raptor (with Rear Parking Brake)	90		2010	2013	R	

FDB333

53.7 x 69.0 x 6.5 mm

MATERIAL AVAILABILITY

AG	EF	P	PRP	ST	SM	SG	ZR	XRAC	ZRAC	CP1	CPRO
		✓	✓								

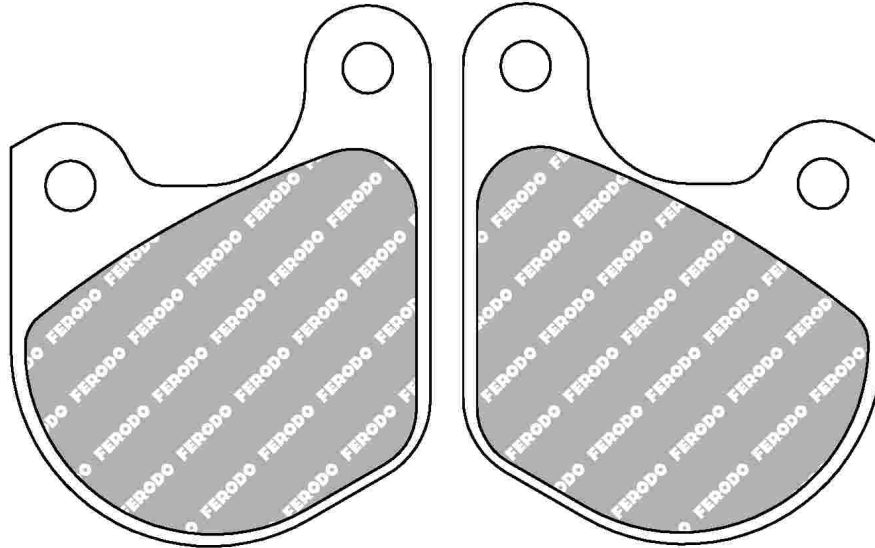

CROSS REFERENCE

BREMBO	07HD02
CL BRAKES	2700
EBC	FA071
GALFER	FD058
LUCAS/TRW	MCB511
NEWFREN	FD0153
SBS	537
VESRAH	VD-908

		CC	KW	FROM	TO	FRONT REAR	LEFT RIGHT
	HARLEY DAVIDSON						
M	XLX	883		1983		F	
M	XLCR 1000 Cafe Racer	1000		1977	1978	F	
M	XLCH 1000 Sportster	1000		1978	1979	F	
M	XLH 1000 Sportster	1000		1978	1981	F	
M	XLH 1000 Sportster	1000		1982	1983	F	
M	XLS 1000 Roadster	1000		1979	1981	F	
M	XLS 1000 Roadster	1000		1982	1983	F	
M	FX Super Glide	1340		1978	1981	F	
M	FXB Sturgis Belt	1340		1977	1981	F	
M	FXB Sturgis Belt	1340		1982		F	
M	FXE Super Glide	1340		1978	1981	F	

		CC	KW	FROM	TO	FRONT REAR	LEFT RIGHT
							
M	FXE Super Glide	1340		1982	1983	F	
M	FXEF Super Glide	1340		1978	1981	F	
M	FXR Super Glide II	1340		1982	1983	F	
M	FXRS Super Glide II	1340		1982	1983	F	
M	FXRT Sport Glide	1340		1983		F	
M	FXS Sturgis	1340		1977	1981	F	
M	FXS Sturgis	1340		1982		F	
M	FXSB Low Rider	1340		1983		F	
M	FXWG Wide Glide	1340		1980	1981	F	
M	FXWG Wide Glide	1340		1982	1983	F	

M = MOTORCYCLE
S = SCOOTER
A = ATV
Sn = SNOWMOBILE

FDB334

71.1 x 89.3 x 6.5 mm

MATERIAL AVAILABILITY											
AG	EF	P	PRP	ST	SM	SG	ZR	XRAC	ZRAC	CP1	CPRO
		✓	✗								

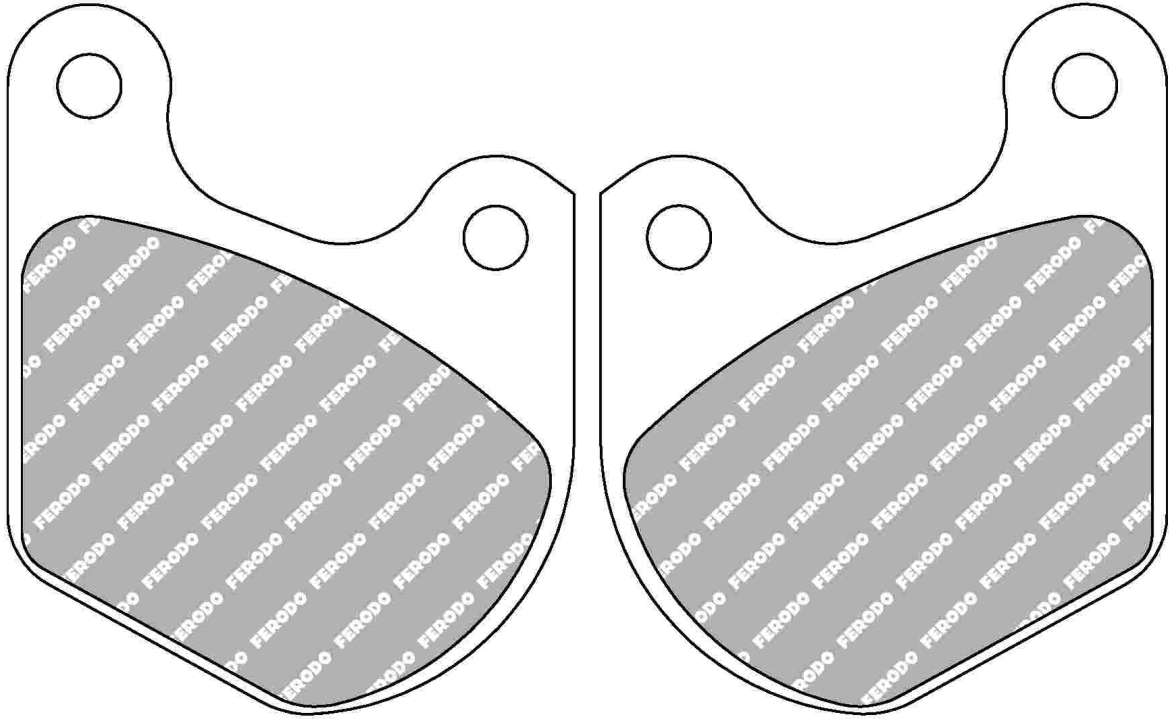

CROSS REFERENCE	
BREMBO	07HD03
CL BRAKES	2718
EBC	FA072
GALFER	FD059
LUCAS/TRW	MCB518
NEWFREN	FD0154
SBS	543
VESRAH	VD-909

		CC	KW	FROM	TO	FRONT / REAR	LEFT / RIGHT
 HARLEY DAVIDSON	M XLCR 1000 Cafe Racer	1000		1977	1978	R	
	M XLCH 1000 Sportster	1000		1978	1979	R	
	M XLH 1000 Sportster	1000		1978	1981	R	

		CC	KW	FROM	TO	FRONT / REAR	LEFT / RIGHT
 M	XL S 1000 Roadster	1000		1979	1981	R	
	FLHT Electra Glide (all models)	1340		1983		F	
	FLT Tour Glide (all models)	1340		1980	1983	F	

FDB335

75.0 x 49.0 x 11.9 mm

MATERIAL AVAILABILITY

AG	EF	P	PRP	ST	SM	SG	ZR	XRAC	ZRAC	CP1	CPRO
		✓	✓								

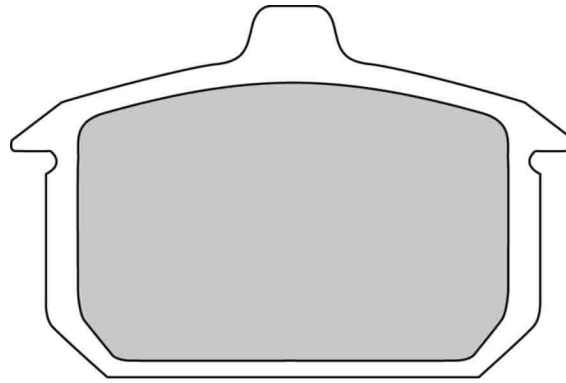

CROSS REFERENCE

BREMBO	07HD04
CL BRAKES	2701
EBC	FA078
GALFER	FD064
LUCAS/TRW	MCB527
NEWFREN	FD0155
SBS	549
VESRAH	VD-918

		CC	KW	FROM	TO	FRONT REAR	LEFT RIGHT
	S XL 883 EVO	883		1986	1987	R	
	M XLX	883		1983		R	
	M XLX	883		1984	1985	R	
	M XLH 1000 Sportster	1000		1982	1983	R	
	M XLH 1000 Sportster	1000		1984	1985	R	
	M XLS 1000 Roadster	1000		1982	1983	R	
	M XLS 1000 Roadster	1000		1984	1985	R	
	M XR 1000	1000		1983	1985	R	
	M XL 1100 EVO	1100		1986		R	
	M FLST Heritage Softail	1340				R	
	M FXB Sturgis Belt	1340		1982		R	
	M FXE Super Glide	1340		1982	1983	R	
	M FXE Super Glide	1340		1984	1985	R	
	M FXEF Super Glide	1340		1984	1985	R	
	M FXLR Low Rider Custom	1340			2000	R	

		CC	KW	FROM	TO	FRONT REAR	LEFT RIGHT
	M FXR Super Glide II	1340		1982	1983	R	
	M FXRS Super Glide II	1340		1982	1983	R	
	M FXRT Sport Glide	1340		1983		R	
	M FXRS Low Glide	1340		1984		R	
	M FXRT Sport Glide	1340		1984		R	
	M FXR Super Glide	1340		1986		R	
	M FXRD Sport Glide Grand Touring	1340		1986		R	
	M FXS Sturgis	1340		1982		R	
	M FXSB Low Rider	1340		1983		R	
	M FXSB Low Rider	1340		1984	1985	R	
	M FXST Softail	1340		1984	1986	R	
	M FXSTC Softail Custom	1340		1986		R	
	M FXWG Wide Glide	1340		1982	1983	R	
	M FXWG Wide Glide	1340		1984	1986	R	

M = MOTORCYCLE
S = SCOOTER
A = ATV
Sn = SNOWMOBILE

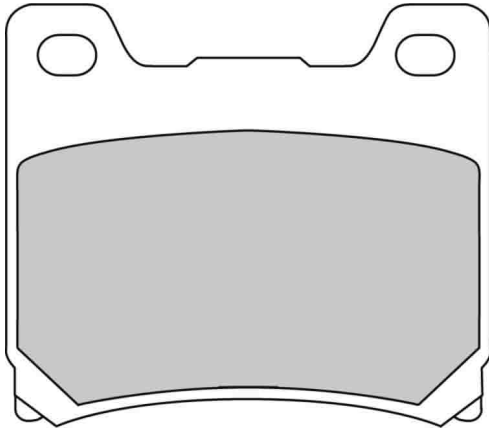

FDB337

63.7 x 54.5 x 9.7 mm



MATERIAL AVAILABILITY											
AG	EF	P	PRP	ST	SM	SG	ZR	XRAC	ZRAC	CP1	CPRO
	✓	✓		✓							

CROSS REFERENCE	
BRAKING	661
BREMBO	07YA11
BRENTA	3053
BRENTA	4053
CL BRAKES	2283
EBC	FA088
GALFER	FD057
GOLD FREN	015
NEWFREN	FD0068
SBS	555
VESRAH	VD-236

		CC	KW	FROM	TO	FRONT REAR	LEFT RIGHT
	NORTON						
	M COMMANDER	580		1990		F	
	M COMMANDER	580		1990		R	
	YAMAHA						
	M 125 BIKAN	125		1991		R	
	M TZR 125	125		1990	1992	F	
	M YD 250 S	250		1991		F	
	M RD 350 YPVS	350		1983	1984	R	
	M FZ 400	400		1986		F	
	M FZR 400 R	400		1987	1990	R	
	M SRX 400	400		1985	1986	F	
	M SRX 400	400		1990	1996	R	
	M XJR 400 R	400		1997		R	
	M RD 500 LC	500		1984	1986	F	
	M RD 500 YPVS LC	500		1984	1987	F	
	M FZ 600	600		1987	1988	F	
	M FZR 600	600		1989		F	
	M FZR 600	600		1989		R	
	M FZR 600 R	600		1990		R	
	M FZR 600 R	600		1991	1995	R	
	M XJ 600 RADIAN	600		1984	1991	F	
	M XJ 600 RADIAN	600		1984	1991	R	
	M YZF 600 R THUNDERCAT	600		1996	2003	R	
	M FZ 750	750		1985	1986	F	
	M FZ 750	750		1985	1986	R	
	M FZ 750 GENESIS	750		1987	1988	F	
	M FZ 750 GENESIS	750		1987	1988	R	
	M FZ 750 GENESIS	750		1989	1992	R	
	M FZR 750 GENESIS	750		1987		R	
	M FZR 750 (O W01)	750		1989	1991	R	
	M FZX 750	750		1987		F	
	M FZX 750	750		1987		R	
	M XJ 750 F	750		1984		F	
	M XJ 750 F	750		1984		R	
M XV 750	750		1989	1993	F		
M XV 750 VIRAGO	750		1992	1993	F		
M YZF 750 RR-SP	750		1993	1998	R		
M TDM 850	850		1991	1995	R		
M TDM 850	850		1996	2001	R		

		CC	KW	FROM	TO	FRONT REAR	LEFT RIGHT
	YAMAHA						
	M TRX 850	850		1995	1999	R	
	M XJ 900	900		1983	1984	F	
	M XJ 900	900		1983	1984	R	
	M XJ 900 SECA DIVERSION	900		1995	2003	R	
	M XJ 900 F	900		1985	1994	F	
	M XJ 900 F	900		1985	1994	R	
	M XJ 900 F DIVERSION	900		1995		R	
	M FZR 1000 GENESIS - EX-UP	1000		1986	1988	R	
	M FZR 1000 R - EX-UP	1000		1989	1990	R	
	M FZR 1000 EX-UP	1000		1991	1993	R	
	M FZR 1000 GENESIS - EX-UP	1000		1994	1995	R	
	M FZR 1000 R	1000		1994	1995	R	
	M GTS 1000	1000		1993	1999	R	
	M XV 1000 VIRAGO	1000		1986	1988	F	
	M YZF 1000 THUNDERACE	1000		1996	2001	R	
	M BT 1100 BULLDOG	1100		2002		R	
	M FJ 1100 J	1100		1984	1985	F	
	M FJ 1100 J	1100		1984	1985	R	
	M XV 1100 VIRAGO	1100		1989	1993	F	
	M XVS 1100 DRAG STAR / CLASSIC	1100		1999		R	
	M FJ 1200	1200		1986	1987	F	
	M FJ 1200	1200		1986	1987	R	
	M FJ 1200	1200		1988	1989	R	
	M FJ 1200 W - WC	1200		1989	1991	R	
	M FJ 1200 ABS	1200		1991	1995	R	
	M FJ 1200	1200		1999		R	
	M XJR 1200	1200		1994		R	
	M XJR 1200	1200		1995	1998	R	
	M XVZ 1200 12 T TD	1200		1985	1987	F	
	M XVZ 1200 12 T TD	1200		1985	1987	R	
M YMX 1200 12N V-MAX	1200			1992	F		
M YMX 1200 12N V-MAX	1200			1992	R		
M YMX 1200 12N V-MAX	1200		1993	2003	R		
M XJR 1300 SP	1300		1999	2001	R		
M XJR 1300 Racer	1300		2015		R		
M XJR 1300	1300		2015		R		

FDB338

53.0 x 53.0 x 9.0 mm

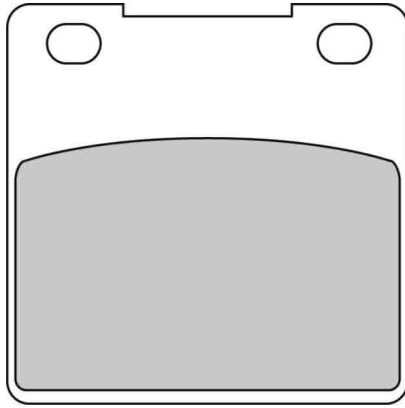

MATERIAL AVAILABILITY											
AG	EF	P	PRP	ST	SM	SG	ZR	XRAC	ZRAC	CP1	CPRO
	✓	✓		✓							

CROSS REFERENCE	
BRAKING	719
BREMBO	07KS05
BRENTA	3052
BRENTA	3054
BRENTA	4052
BRENTA	4054
CL BRAKES	2282
EBC	FA063
EBC	FA161
GALFER	FD111
LUCAS/TRW	MCB531
NEWFREN	FD0134
SBS	556
VESRAH	VD-327
VESRAH	VD-416

		CC	KW	FROM	TO	FRONT / REAR	LEFT / RIGHT
	KAWASAKI						
	M ZX 400 L	400		1992		R	
	M ZXR 400	400		1991		R	
	M ZXR 400 (ZX400-L)	400		1992		R	
	M ZX-7 750 R NINJA	750		1989	1995	R	
	M ZX-7 750 R NINJA	750		1996	2003	R	
	M ZX-7 750 R NINJA (Racing Applications)	750		1996	2003	R	
	M ZXR 750	750		1989	1990	R	
	M ZXR 750 R	750		1993	1995	R	
	M ZR 1100 C1	1100		1997	2000	R	
	M ZRX 1100	1100		1996	2000	R	
	M ZZR 1100 GT (ZX 1100 D)	1100		1993	2001	R	
	M ZRX 1200 R - S	1200		2000		R	
	M ZRX 1200 R - S	1200		2001		R	
	M ZX 12 1200 R	1200		2000	2003	R	
	M ZX 12 1200 R (Racing Applications)	1200		2000	2003	R	
	M ZX-12R 1200	1200		2004		R	
	M ZZR 1200	1200		2002		R	
	SUZUKI						
	M RG 50 GAG - GAMMA	50		1987		F	
	M ACROSS 250	250		1990		R	
	M 250 BANDIT	250		1990		R	
	M COBRA 250	250		1989		R	
	M COBRA 250	250		1990		R	
	M GF 250 S	250		1986		R	
	M GOOSE 250	250		1992		R	
	M GS 250 FW	250		1984		F	
	M GS 250 FW	250		1984		R	
	M GSF 250 BANDIT	250		1990		R	
	M GSX 250 S KATANA	250		1991		R	
	M GSX-R 250	250		1987	1988	R	
	M GSX-R 250 R - R/SP	250		1989		R	
	M RG 250 W GAMMA	250			1983	F	
	M RG 250 W GAMMA	250			1983	R	
	M RG 250 W GAMMA	250		1984	1987	R	

		CC	KW	FROM	TO	FRONT / REAR	LEFT / RIGHT
	SUZUKI						
	M RGV 250 R	250		1988		R	
	M RGV 250 R	250		1989		R	
	M WOLF 250	250		1990		R	
	M GOOSE 350	350		1992		R	
	M GSF 400 S KATANA	400		1989	1990	R	
	M GSF 400 BANDIT	400		1991	1992	R	
	M GSF 400 BANDIT	400		1993	1994	R	
	M GSF 400 BANDIT	400		1995	1997	R	
	M GSX 400 FWS - D - E	400		1983		F	
	M GSX 400 FWS - D - E	400		1983		R	
	M GSX 400 S	400		1983		F	
	M GSX 400 S	400		1983		R	
	M GSX 400 R I/II	400		1985	1986	R	
	M GSX 400 X IMPULSE 400	400		1986	1988	R	
	M GSX 400 KATANA	400		1989	1992	R	
	M GSX 400 IMPULSE	400		1994	1996	R	
	M GSX-R 400 (III-IV)	400			1988	R	
	M GSX-R 400 (JAPAN)	400		1985		F	
	M GSX-R 400 (V)	400		1989	1990	R	
	M GSX-R 400 R	400		1990	1995	R	
	M GSX-R 400	400		1990		R	
	M RF 400 RVC	400		1993		R	
	M RG 400 GAMMA	400		1985		R	
	M GS 450 S	450		1987		R	
	M GS 500 E - K - L - M	500		1989	1993	R	
	M GS 500 E - K - FK	500		1996		R	
	M RG 500 RF GAMMA	500		1985	1987	R	
M GSX 550 ES - ESE	550		1983	1987	F		
M GSX 550 ES - ESE	550		1983	1987	R		
M GSX 550 ESD - ES4	550		1983	1987	F		
M GSX 550 ESD - ES4	550		1983	1987	R		
M GSX 550 EF - EFE	550		1983	1987	F		
M GSX 550 EF - EFE	550		1983	1987	R		

M = MOTORCYCLE
S = SCOOTER
A = ATV
Sn = SNOWMOBILE

		CC	KW	FROM	TO	FRONT / REAR	LEFT / RIGHT
	M GSX 550 ET - EV	550		1987		F	
	M GSX 550 ET - EV	550		1987		R	
	M GSF 600 BANDIT	600		1995	1999	R	
	M GSF 600 BANDIT - KATANA	600		1998		R	
	M GSF 600 BANDIT	600		2000		R	
	M GSX 600 F KATANA	600		1988	1993	R	
	M GSX-R 600 F	600		1994	1995	R	
	M GSX-R 600 V	600		1996	2003	R	
	M RF 600 RR	600		1993	1997	R	
	M SV 650 S (Top Fairing - Non ABS)	650		1999	2002	R	
	M SV 650 (Naked - Non ABS)	650		1999	2002	R	
	M GSX 750 LIMITED EDITION	750		1986		R	
	M GSX 750 EF	750		1987		R	
	M GSX 750 FK/FL/FM/FN/FP/FR/FS/FT/FV	750		1989	1997	R	
	M GSX 750 FW/FX/FY/FK1/FK2	750		1998	2006	R	
	M GSX 750 W/X/Y/K1	750		1998		R	
	M GSX-R 750 LTD Special Edition	750		1987	1988	R	

		CC	KW	FROM	TO	FRONT / REAR	LEFT / RIGHT
	M GSX-R 750	750		1988	1993	R	
	M GSX-R 750 W	750		1994	1999	R	
	M GSX-R 750 W (Racing Applications)	750		1994	1999	R	
	M GSX-R 750 Y	750		2000	2003	R	
	M GT 750 RF	750		1985	1986	R	
	M RF 900 RT - RV	900		1996	1999	R	
	M TL 1000 SV TWIN	1000		1997	2001	R	
	M TL 1000 R	1000		1998	2002	R	
	M GSX 1100 GM	1100		1991	1992	R	
	M GSX-R 1100	1100		1985	1988	R	
	M GSX-R 1100 K - L - M - N	1100		1989	1992	R	
	M GSX-R 1100 W (Racing Applications)	1100		1991	1996	R	
	M GSX-R 1100 W	1100		1993	1996	R	
	M GSF 1200 T-ST-V-SV- BANDIT	1200		1995	2000	R	
	M GSF 1200 K1/SK1 BANDIT	1200		2001		R	
	M GSX 1200	1200		1999	2000	R	
	M GSX-R 1300 HAYABUSA (Racing Applications)	1300		1999	2007	R	

FDB339

111.0 x 51.0 x 9.4 mm / 68.0 x 43.0 x 9.8 mm

MATERIAL AVAILABILITY											
AG	EF	P	PRP	ST	SM	SG	ZR	XRAC	ZRAC	CP1	CPRO
	✓	✓		✓							

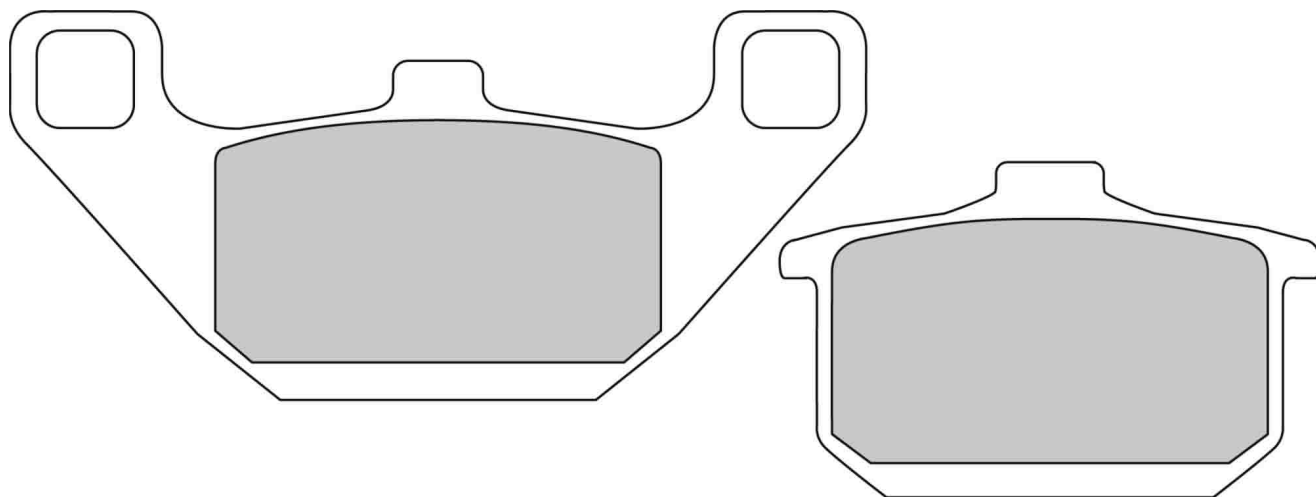

CROSS REFERENCE	
BRAKING	662
BREMBO	07KA08
BRENTA	3061
BRENTA	4061
CL BRAKES	2285
EBC	FA085
GALFER	FD062
GOLD FREN	037
LUCAS/TRW	MCB532
NEWFREN	FD0072
SBS	557
VESRAH	VD-426



		CC	KW	FROM	TO	FRONT / REAR	LEFT / RIGHT
HYOSUNG	M GA 300	300		1998		F	
KAWASAKI	M EL 250 all models	250		1991	1994	F	
	M EX 250 NINJA	250		1986	1987	F	
	M EX 250 NINJA	250		1986	1987	R	
	M GPZ 250	250		1985		R	
	M LX 250 ELIMINATOR - SE	250		1990		F	
	M Z 250 GP BELT DRIVE	250		1983		F	
	M Z 250	250		1983		F	
	S GPX 400	400		1985		R	
	M GPZ 400	400		1985	1987	R	
	M KLE 400 VULCAN	400		1990		F	
	M VN 400 VULCAN	400		1995		F	
	M Z 400 F2	400		1985	1987	R	
	M ZL 400	400		1986	1987	F	
	M ZL 400 ELIMINATOR	400		1988	1992	F	
	M ZL 400 ELIMINATOR	400		1988	1992	R	
	M ZL 400 ELIMINATOR	400		1993		R	
	M ZX 400 C2	400		1985		R	
	M LTD450 (EN450 A1-A5)	454		1986	1989	F	
	M EN 500 all models	500		1990	1993	F	
	M GPZ 500 S	500		1987		F	
	M GPZ 500 S	500		1989	1992	R	
	M GPZ 600 R	600		1985	1989	F	
	M GPZ 600 R	600		1985	1989	R	
	M ZL 600 A1/A2	600		1985	1994	F	
	M 750 BELT DRIVE	750		1985	1987	F	
	M 750 BELT DRIVE	750		1985	1987	R	
	M GPZ 750	750		1985	1986	F	
	M GPZ 750	750		1985	1986	R	
	M GPZ 750 R1	750		1985	1987	F	
	M GPZ 750 R1	750		1985	1987	R	
	M 750 TURBO	750		1985	1987	F	
	M 750 TURBO	750		1985	1987	R	
	M VN 750 TWIN	750		1986	1987	F	
	M VN 750	750		1988	1989	F	
	M VN 750	750		1988	1989	R	
	M VN 750 VULCAN	750		1990	1994	F	
	M 750 VULCAN	750		1989	1993	F	
	M Z 750 GP	750		1983		F	



		CC	KW	FROM	TO	FRONT / REAR	LEFT / RIGHT
	M Z 750 GP	750		1983		R	
	M ZX 750 E1 TURBO	750		1983	1985	F	
	M ZX 750 E1 TURBO	750		1983	1985	R	
	M ZX 750 A1	750		1983	1985	F	
	M ZX 750 A1	750		1983	1985	R	
	M VN 800	800		1995	1998	F	
	M VN 850	850		1995	1999	F	
	M GPZ 900 R (ZX900A or NINJA 900)	900		1984	1989	F	
	M GPZ 900 R (ZX900A or NINJA 900)	900		1984	1989	R	
	M GPZ 1000 RX - RY	1000		1986		F	
	M GPZ 1000 RX - RY	1000		1986		R	
	M GTR 1000	1000		1986	1993	F	
	M GTR 1000	1000		1986	1993	R	
	M VN 1000 VULCAN	1000		1987		F	
	M VN 1000 VULCAN	1000		1987		R	
	M Z 1000 GTR (ZG 1000)	1000		1986	1993	F	
	M Z 1000 GTR (ZG 1000)	1000		1986	1993	R	
	M Z 1000 GTR	1000		1994	2003	R	
	M ZL 1000 all models	1000		1987		F	
	M ZL 1000 all models	1000		1987		R	
	M GPZ 1100 (ZX 1100 A1)	1100		1983	1985	F	
	M GPZ 1100 (ZX 1100 A1)	1100		1983	1985	R	
	M VN 1100	1100		1987		F	
	M VN 1100	1100		1987		R	
	M Z 1100 R1	1100		1984		F	
	M Z 1100 R1	1100		1984		R	
	M ZX 1100 A1	1100		1983	1984	F	
	M ZX 1100 A1	1100		1983	1984	R	
	M KZ 1200	1200		1987		F	
	M KZ 1200	1200		1987		R	
	M ZG 1200 VOYAGER	1200		1986		F	
	M ZG 1200 VOYAGER	1200		1986		R	
	M ZG 1200	1200		1986	1990	F	
	M ZG 1200	1200		1986	1990	R	
	M VN 1500 all models	1500		1987	1993	F	
	M VN 1500 all models	1500		1987	1993	R	
	M VN 1500 D1/D2 CLASSIC	1500		1996	1998	R	
	M VN 1500 CLASSIC TOURER	1500		1999		R	

M = MOTORCYCLE
S = SCOOTER
A = ATV
Sn = SNOWMOBILE

FDB342

59.5 x 51.5 x 10.2 mm

August 2018: CP1 superseded by CPRO

MATERIAL AVAILABILITY											
AG	EF	P	PRP	ST	SM	SG	ZR	XRAC	ZRAC	CP1	CPRO
		✓		✗							✓

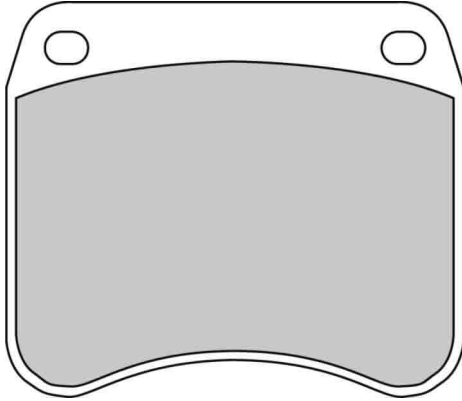

Pinze / Calipers

AP RACING

CP2195 (2 Piston)

CP2696 (2 Piston)

Fontana

2-Piston

Kelgate

2 & 4-Piston

Lockheed

2-Piston

Spondon

Spondon 2 Piston

CROSS REFERENCE

BREMBO	07GR66
EBC	FA016
GALFER	FD008
LUCAS/TRW	MCB99
NEWFREN	FD0008
SBS	523
VESRAH	VD-906

		CC	KW	FROM	TO	FRONT / REAR	LEFT / RIGHT
	DUCATI	M 750 SPORT	750	1974	1976	F	
	TRIUMPH	M BONNEVILLE T 400 V E	400		1981	F	
		M BONNEVILLE T 400 V E	400		1981	R	
		M BONNEVILLE T 400 V E	400	1982	1984	R	
		M TRIDENT TI 500 V	500		1981	F	
		M TRIDENT TI 500 V	500		1981	R	

		CC	KW	FROM	TO	FRONT / REAR	LEFT / RIGHT
	M	TRIDENT TI 500 V	500		1982	1984	R
	M	BONNEVILLE 750 TWIN (Lockheed calipers)	750		1975	1981	F
	M	BONNEVILLE 750 TWIN (Lockheed calipers)	750		1975	1981	R
	M	BONNEVILLE 750 TWIN (Lockheed calipers)	750		1982	1984	R
	M	TIGER 750 TR 7V	750			1975	F
	M	TIGER 750 TR 7V	750		1976	1981	R

FDB352

59.2 x 61.8 x 13.0 mm

December 2019: PRP superseded by P

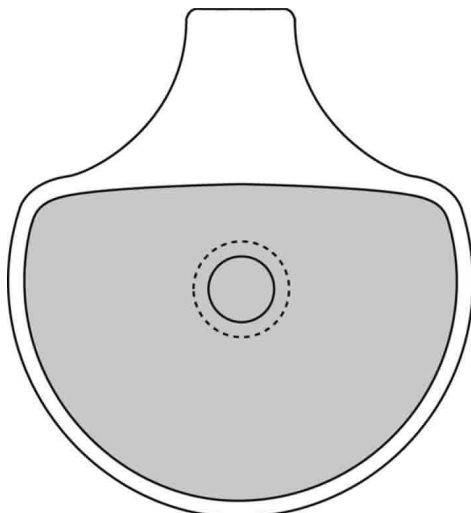

MATERIAL AVAILABILITY											
AG	EF	P	PRP	ST	SM	SG	ZR	XRAC	ZRAC	CP1	CPRO
		✓		✓							

CROSS REFERENCE	
BRAKING	732
BREMBO	07HD06
CL BRAKES	2699
EBC	FA094
GALFER	FD124
LUCAS/TRW	MCB548
NEWFREN	FD0157
SBS	579
VESRAH	VD-919

		CC	KW	FROM	TO	FRONT / REAR	LEFT / RIGHT
	S XL 883 EVO	883		1986	1987	F	
	S XL 883 EVO	883		1987	1999	F	
	M XLH Sportster 883 Hugger	883		1992	1993	F	
	M XLX	883		1984	1985	F	
	M XLH 1000 Sportster	1000		1984	1985	F	
	M XLS 1000 Roadster	1000		1984	1985	F	
	M XR 1000	1000		1983	1985	F	
	M XL 1100 EVO	1100		1986		F	
	M XL 1200 EVO	1200			1999	F	
	M FLHR Road King (all models)	1340		1994	1999	F	
	M FLHS Electra Glide Sport	1340			1993	F	
	M FLHT Electra Glide (all models)	1340		1984	1985	F	
	M FLHT Electra Glide (all models)	1340		1986	1999	F	
	M FLST Heritage Softail	1340				F	
	M FLST Heritage Softail	1340			1990	F	
	M FLSTC Heritage Softail Classic	1340		1987	1999	F	
	S FLSTF Fat Boy	1340		1990	1999	F	
	S FLSTN Heritage Softail	1340		1993	1996	F	
	M FLSTS Heritage Springer Softail	1340		1997	1999	F	
	M FLT Tour Glide (all models)	1340		1984	1985	F	
	M FLT Tour Glide (all models)	1340		1986	1999	F	
	M FLTR Road Glide (all models)	1340		1998	1999	F	
	M FXD Dyna Super Glide	1340		1995	1999	F	
	M FXDB Dyna Street Bob	1340		1991	1992	F	
	M FXDC Dyna Super Glide Custom	1340		1991	1992	F	
	M FXDG Dyna Glide Sturgis	1340		1991		F	
	M FXDL Low Rider	1340		1993	1999	F	
	M FXDS-Conv. / Dyna Convertible	1340		1994	1999	F	
	M FXDWG Wide Glide	1340		1993	1999	F	
	M FXDX Dyna Super Glide Sport	1340		1995	1999	F	

		CC	KW	FROM	TO	FRONT / REAR	LEFT / RIGHT
	M FXE Super Glide	1340		1984	1985	F	
	M FXEF Super Glide	1340		1984	1985	F	
	M FXLR Low Rider Custom	1340			2000	F	
	M FXLR Low Rider Custom	1340			1994	F	
	M FXR Super Glide	1340			1994	F	
	M FXRS Low Glide	1340			1992	F	
	M FXRT Sport Glide	1340			1992	F	
	M FXRS Low Glide	1340		1984		F	
	M FXRT Sport Glide	1340		1984		F	
	M FXR Super Glide	1340		1986		F	
	M FXRD Sport Glide Grand Touring	1340		1986		F	
	M FXSB Low Rider	1340		1984	1985	F	
	M FXST Softail	1340		1984	1986	F	
	M FXST Softail Standard	1340		1999		F	
	M FXSTB Night Train	1340		1999	1999	F	
	M FXSTC Softail Custom	1340			1999	F	
	M FXSTC Softail Custom	1340		1986		F	
	M FXSTS Springer Softail	1340			1999	F	
	M FXSTSB Bad Boy	1340		1995	1997	F	
	M FXWG Wide Glide	1340		1984	1986	F	
M FLSTS/I Heritage Springer	1450		2000	2003	F		
M FLSTSC/FLSTSCi Springer Classic	1450		2005	2007	F		
M FXSTS/FXSTSi Softail Springer	1450		2000	2005	F		
M FXSTS/FXSTSi Softail Springer	1450		2006		F		
M FLSTSC/FLSTSCi Springer Softail Classic	1584		2006	2007	F		
M FLSTSB Softail Cross Bones	1584		2008	2011	F		
PGO							
S G-Max 125	125		2006	2008	F		
S G-Max 125 (Wave disc)	125		2009	2012	F		
S G-Max 250	250		2006	2008	F		

M = MOTORCYCLE
S = SCOOTER
A = ATV
Sn = SNOWMOBILE

FDB381

46.0 x 45.0 x 7.3 mm

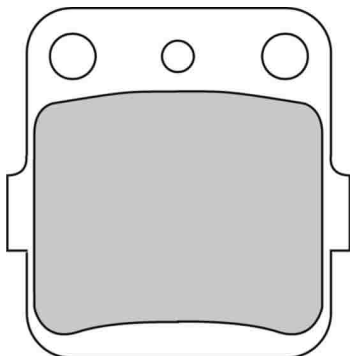

MATERIAL AVAILABILITY											
AG	EF	P	PRP	ST	SM	SG	ZR	XRAC	ZRAC	CP1	CPRO
	✓	✓				✓					

ALSO AVAILABLE

SHAPE	TH. MM	NOTES
FDB661	6.5	

CROSS REFERENCE

BRAKING	686
BREMBO	07HO20
BRENTA	3106
BRENTA	4106
CL BRAKES	2328
EBC	FA084
GALFER	FD076
LUCAS/TRW	MCB561
NEWFREN	FD0078
SBS	562
SBS	592
VESRAH	VD-127/2
VESRAH	VD-127/3
VESRAH	VD-128

		CC	KW	FROM	TO	FRONT / REAR	LEFT / RIGHT
							
ARCTIC CAT	A 400 DVX	400		2004	2008	F	
HONDA	M CR 85 R/RB	85		2003	2007	F	
	M CRF 150 R (Small wheel 17"-14")	150		2007	2015	F	
	M CRF 150 R (Big wheel 19"-16")	150		2007	2015	F	
HONDA 3 WHEELERS	A ATC 200 X (Disc Brake)	200		1983	1987	F	
	A ATC 200 X (Disc Brake)	200		1983	1987	R	
	A ATC 250 R	250		1983	1984	F	
	A ATC 250 R	250		1983	1984	R	
	A ATC 350 X	350		1985	2000	R	
	A ATC 350 X	350		1986	2000	R	
HONDA ATV	A TRX 250 X Fourtrax	250		1987	1992	F	
	A TRX 250 X Fourtrax	250		1987	1992	R	
	A TRX 250 EX	250		2001	2008	F	
	A TRX 250 X	250		2009	2011	F	
	A TRX 300 EX Fourtrax	300		1993	2008	F	
	A TRX 300 EX Fourtrax	300		1993	2008	R	
	A TRX 300 X	300		2009		F	
	A TRX 300 X	300		2009		R	
	A TRX 400 FW / FM Fourtrax Foreman	400		1995	2003	F	
	A TRX 400 EX Fourtrax/Sportrax	400		1999	2008	F	
	A TRX 400 EX Fourtrax/Sportrax	400		1999	2008	R	
	A TRX 400 X	400		2009		F	
	A TRX 400 X	400		2009		R	
	A TRX 420 TM/TE/FE/FM Fourtrax Rancher	420		2007	2010	F	
	A TRX 420 FA/FPA P.S.Fourtrax Rancher	420		2009	2010	F	
	A TRX 420 FPE/FPM Fourtrax Rancher 4x4	420		2009	2010	F	
HUSQVARNA	M WR 250	250		1992	1994	R	
KAWASAKI	M KX 80 R7-T7-W1/2-Y1/2	80		1997	2000	R	
	M KX 80 R3	80		1993	1996	R	
	M KX 80 S1 - V1	80		1988	1991	R	
	M KX 85 / 85-2 A1 / B1	85		2001		R	
	M KX 100	100		1988	1991	R	
	M KX 100 B7 / C1 / C2 / C3	100		1997	2000	R	

		CC	KW	FROM	TO	FRONT / REAR	LEFT / RIGHT
							
KAWASAKI 3 WHEELERS	A KXT 250 B2 TECATE	250		1987	2000	R	
KAWASAKI ATV	A KSF 250 MOJAVE A Series	250		1987	2005	R	
	A KXF 250 Tecate	250		1987	1988	R	
	A KEF 300 LAKOTA A Series, LAKOTA SPORT B Series	300		1995	2003	R	
	A KSF 400 / KFX 400	400		2004	2006	F	
	A KVF 400 PRAIRIE (2x4/4x4)	400		1997	2002	F	
	A KFX 450 R	450		2008	2012	R	
	A KSF 450 / KFX 450	450		2007		F	
KYMCO ATV	M MXU 400 Parking brake	400		2008	2011	F	
SUZUKI	M RM 65	65		2003		R	
SUZUKI ATV	A LT 230 EH/EJ/EK/EL/EM/EN/EP	230		1986	1993	R	
	A LT 230 S QUADSPORT	230		1989		R	
	A LT 250 R	250		1985	1986	R	
	A LT 250 S	250		1989	1990	R	
	A LT-Z 250 K QuadSport	250		2004	2009	F	
	A LT-Z 400 QUADSPORT	400		2003	2012	F	
YAMAHA ATV	A YFS 200 BLASTER	200		2003	2006	R	
	A YFM 250 BEAR TRACKER	250		2001	2004	F	
	A YFM 250 R Raptor	250		2008		R	
	A YFM 250 RSPX Special Edition Custom	250		2008		R	
	A YFM 350 XW-XS WARRIOR	350		1989	2004	R	
	A YFM 350 FX WOLVERINE	350		1995	2007	R	
	A YFM 350 RAPTOR	350		2004	2010	F	
	A YFM 350 RAPTOR	350		2004	2010	R	
	A YFM 350 2x4 Grizzly	350		2007	2010	R	
	A YFZ 350 T/U/W BANSHEE	350		1987	1989	R	
	A YFZ 350 A/B/D/E/F BANSHEE	350		1990	2006	R	
	A YFZ 450	450		2004	2005	R	
	A YFM 600 GRIZZLY (All)	600		1998	2001	F	
	A YFM 660 RAPTOR	660		2001	2005	F	
	A YFM 660 RAPTOR	660		2001	2005	R	
	A YFM 660 GRIZZLY	660		2002	2008	F	
	A YFM 660 Ducks Unlimited Ed.-side by side	660		2006	2007	F	

FDB382

81.0 x 42.0 x 7.3 mm

MATERIAL AVAILABILITY											
AG	EF	P	PRP	ST	SM	SG	ZR	XRAC	ZRAC	CP1	CPRO
		✓				✓					

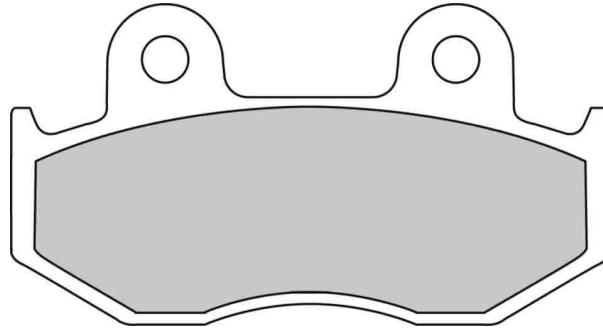

ALSO AVAILABLE		
SHAPE	TH. MM	NOTES
FDB2086	8.3	
FDB2119	9.0	
FDB2132	8.3	pin on the backplate

CROSS REFERENCE	
BRAKING	667
BRAKING	940
BREMBO	07HO15
BREMBO	07HO32
BREMBO	7078
BRENTA	3034B
BRENTA	4044B
CL BRAKES	2451
CL BRAKES	3019
EBC	FA092
EBC	SFA323/2
GALFER	FD063
LUCAS/TRW	MCB534
NEWFREN	FD0067
SBS	558
VESRAH	VD-134
VESRAH	VD-134/2

		CC	KW	FROM	TO	FRONT / REAR	LEFT / RIGHT
	HONDA						
	M CR 50 R	50		1986		F	
	M CR 125 RE	125		1984	1985	F	
	M CR 125 RG	125		1986	1986	F	
	M MTX 125 R2F	125		1985	1995	F	
	M MTX 125 RWF	125		1985	1995	F	
	M MTX 125 RF	125		1985	1995	F	
	M @ 125 NES	125		2001		F	
	M XL 125 R	125		1985	1986	F	
	M XL 125 R PARIS DAKAR	125		1986	1986	F	
	M MTX 200 RW	200		1985	1986	F	
	S CH 250 ELITE/SPACY	250		1985	1986	F	
	S CN 250 HELIX-FUSION	250		1988	1989	F	
	S CN 250 HELIX-FUSION	250		1992	1993	F	
	M CR 250 RE-F	250		1984	1985	F	
	M CR 250 RG	250		1986	1986	F	
	M FTR 250	250		1986		F	
	M FTR 250	250		1986		R	

		CC	KW	FROM	TO	FRONT / REAR	LEFT / RIGHT
	M RX 250 RE	250		1984		F	
	M XLR 250 R	250		1985	1988	F	
	M XR 250 RE - RH	250		1984	1987	F	
	M XL 350 R	350		1985	1985	F	
	M XLX 350	350		1989		F	
	M XR 350 RE - RD	350		1984		F	
	M CR 500 RE-F	500		1984	1985	F	
	M CR 500 RG	500		1986	1986	F	
	M XR 500 R	500		1983	1984	F	
	M XR 500 R	500		1984		F	
	M XL 600 L - PARIS DAKAR	600		1983	1984	F	
	M XL 600 R	600		1983	1984	F	
	M XR 600 R	600		1985	1987	F	
	HONDA 3 WHEELERS						
A ATC 250 R	250		1985	1986	F		
A ATC 250 R	250		1985	1986	R		
A ATC 350 X	350		1985	2000	F		
HONDA ATV							
A TRX 250 R Fourtrax	250		1986	1989	R		

M = MOTORCYCLE
S = SCOOTER
A = ATV
Sn = SNOWMOBILE

FDB383

71.0 x 36.0 x 9.4 mm

July 2016: AG compound superseded by EF

MATERIAL AVAILABILITY											
AG	EF	P	PRP	ST	SM	SG	ZR	XRAC	ZRAC	CP1	CPRO
✗	✓	✓				✓					

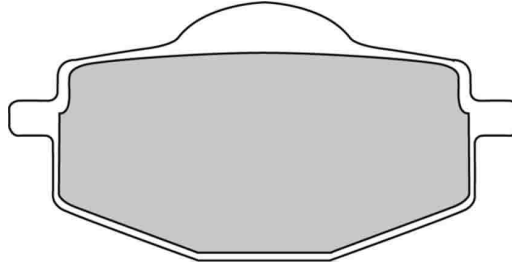

ALSO AVAILABLE		
SHAPE	TH. MM	NOTES
FDB475	8.0	

CROSS REFERENCE	
BRAKING	685
BREMBO	07039
BREMBO	07YA14
BREMBO	7039
BRENTA	3085
BRENTA	4085
CL BRAKES	2284
CL BRAKES	3008
EBC	FA101
LUCAS/TRW	MCB539
NEWFREN	FD0124
SBS	575
VESRAH	VD-239

		CC	KW	FROM	TO	FRONT REAR	LEFT RIGHT
	ADLY	S	Fox 50 / SILVER FOX 50	50	2000		F
	BETA	M	EURO / JONATHAN 350	350	2003	2006	R
	CFMOTO	M	CF 250 T - 5 Custom	250	2011	2012	R
	GILERA	M	APACHE 125	125	1991		R
		M	RC 125 TOP RALLY	125	1989		R
		M	RC 600	600	1989	1990	R
		M	RC 600 TOP RALLY	600	1990		R
		M	RC 600	600	1991		R
		M	RC 600 NORD WEST	600	1991		R
		M	RC 600 R	600	1991		R
	ITALJET	M	MILLENIUUM 100	100	2000	2001	F
		M	MILLENIUUM 125	125	2000	2001	F
		M	MILLENIUUM 150	150	2000	2001	F
	LINHAI	M	LH 50 Prince (Scooter)	50	2007		F
		M	Eggy 125 (Scooter)	125	2007		F
	MALAGUTI	M	CENTRO 125 ie/SL	125	2007	2011	R
		M	CENTRO 160 ie	160	2008		R
	MBK	M	XC 125 FLAME	125	1998		F
		M	XC 125 FLAME R	125	1998		F
	SACHS	M	ROADSTER 650	650	2001		R
	YAMAHA	M	DT 50 R	50	1993	1997	F
		M	50 FLY ONE	50	1992	1995	F
		M	TDR 50	50	1990		F
		M	TDR 50	50	1990		R
		M	TZM 50 R	50	1994		R
		M	TZR 50	50	1990	1996	R
		M	DT 80 LC2	80	1993		F
		M	TZR 80	80	1992		R
		M	DT 125 LC / R	125	1988		R

		CC	KW	FROM	TO	FRONT REAR	LEFT RIGHT
	M	DT 125 R	125	1991	2003	F	
	M	DT 125 R	125	1991	2003	R	
	M	DT 125 RE	125	2004		F	
	M	TD 125 R	125	1993		F	
	M	TD 125 R	125	1993		R	
	M	TDR 125	125	1993	1993	R	
	M	TZR 125	125	1993		R	
	M	XC 125 CYGNUS	125	1996	1997	F	
	M	YBR 125 ED (3D91)	125	2005	2006	F	
	M	YZ 125	125	1988		R	
	M	150 FLY ONE	150	1992		F	
	M	TW 200	200	2001	2003	F	
	M	SEROW 225 XT	225	1985	1992	F	
	M	SEROW 225 XT	225	1993	1995	F	
	M	TT-R 225	225	1999	2002	F	
	M	YZ 250	250	1988		R	
	M	TT 350	350	1991	1995	R	
	M	XT 350	350	1992	1995	F	
	M	400 ARTESIA	400	1991		R	
	M	WR 500 B	500	1991	1992	R	
	M	XT 600 E - K	600	1991	1994	R	
	M	XT 600 E - K	600	1995	2003	R	
	M	XT 600 Z TENERE	600	1991		R	
	M	XTZ 660 TENERE	660	1991	1998	R	
	YAMAHA 3 WHEELERS	A	YTZ 250 N/S	250	1985	1986	F
		A	YTZ 250 N/S	250	1985	1986	R
	YAMAHA ATV	A	YFM 350 XT/XU WARRIOR	350	1987	1988	F
		A	YFZ 350 T/U/W BANSHEE	350	1987	1989	F

FDB384

88.1 x 49.1 x 7.5 mm / 56.1 x 36.1 x 10.0 mm

MATERIAL AVAILABILITY

AG	EF	P	PRP	ST	SM	SG	ZR	XRAC	ZRAC	CP1	CPRO
		✓									

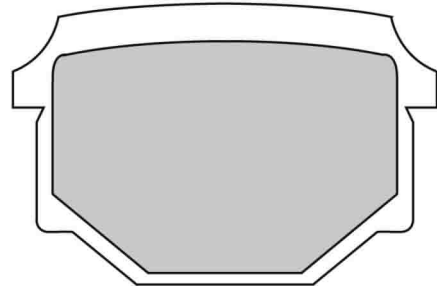
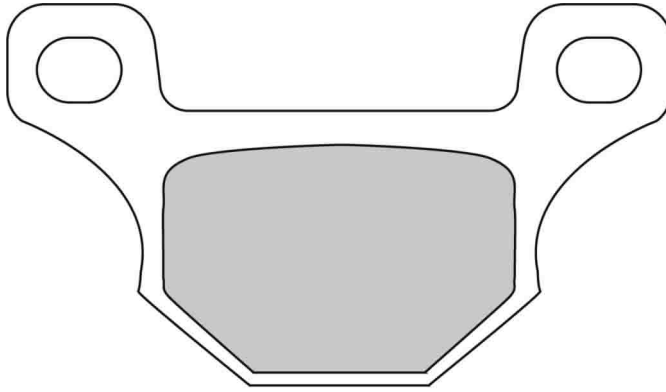

CROSS REFERENCE

BREMBO	07GR09
EBC	FA093
GALFER	FD252
LUCAS/TRW	MCB765
NEWFREN	FD0077
SBS	203
SBS	585
VESRAH	VD-346

		CC	KW	FROM	TO	FRONT REAR	LEFT RIGHT
	AJP	M	PR4 Enduro 125	125	2010	2012	R
		M	PR4 Enduro Pro 125	125	2010	2012	R
		M	PR4 Supermoto 125	125	2010	2012	R
		M	PR4 Supermoto Pro 125	125	2010	2011	R
		M	PR4 200 Supermoto Pro	200	2010	2011	R
		M	PR4 Enduro 200	200	2010	2011	R
		M	PR4 Enduro Pro 200	200	2010	2011	R
		M	PR4 200 Supermoto	200	2010	2011	R
	APRILIA	M	RS4 50 (AJP caliper)	50	2011		R
M		RS4 125 4T (AJP caliper)	125	2011		R	
M		RX 125 (AJP Caliper F&R)	125	2008	2013	R	
CFMOTO	M	CF 150 Leader	150	2010	2012	F	
DERBI	M	GPR 50	50	2010		R	
	M	SENDA DRD Evo 50	50	2008		R	
	M	GPR 125	125	2010		R	
	M	MULHACEN CAFE' 125	125	2008		R	
	M	SENDA DRD 125	125	2010		R	
	M	TERRA 125	125	2007	2008	R	
KEEWAY	M	Speed 125/150	125	2007	2012	F	
	M	Speed 125/150	125	2007	2012	R	
PEUGEOT	S	NK7 (50cc) Naked	50	2009	2012	R	
	S	XPS 50 SM	50	2009		F	
	S	XPS 50 SM	50	2009		R	
	S	XPS 50 Top Road (17? F/Wheel)	50	2010	2012	F	
	S	XPS 50 Track (21? F/Wheel)	50	2011	2012	F	
RIEJU	S	XR7 (50cc) Full Fairing	50	2008	2012	R	
	M	MRT 50	50	2008		F	
	M	MRT 50	50	2008		R	

		CC	KW	FROM	TO	FRONT REAR	LEFT RIGHT
	M	MRT 50 PRO / SUPERMOTARD / Competizione	50	2008		R	
	M	MRT 50 SUPERMOTARD	50	2010		F	
	M	MRT 50 SUPERMOTARD	50	2010		R	
	M	RS2 50 MATRIX / PRO 50 (JJUAN)	50	2007	2008	R	
	M	TANGO 50 Motard	50	2009		F	
	M	MARATHON 125 PRO / SUPERMOTARD	125	2008		R	
	M	MARATHON 125 / MOTARD	125	2008		F	
	M	MARATHON 125 / MOTARD	125	2008		R	
	M	RS2 125 / PRO 125 (JJUAN)	125	2007	2008	R	
	SHERCO	M	SU 50 (2T) Urban Base - Cast wheel model)	50	2010		F
	SINNIS	M	QM 125-2 C Vista 125	125	2008		F
		M	QM 125 GY-2D Trackstar 125 (4T)	125	2010		F
	SUZUKI	M	GN 125	125	1983	1993	F
		M	GS 125 ESD	125	1983	1994	F
		M	GS 125 E - KATANA	125	1990	1994	F
TGB	S	302Sport (50cc)	50	2003	2009	F	
	S	309RS 50	50	2002	2003	F	
	S	R50 X Bullet	50	2006	2010	F	
	S	R50 X Bullet	50	2010		F	
	S	303RHawk/Laser (125cc)	125	2004	2008	F	
	S	303RHawk/Laser (125cc)	125	2009		F	
	S	304Sport (125cc)	125	2003	2009	F	
	S	R125 X Bullet	125	2008	2009	F	
	S	R125 X Bullet	125	2010		F	
	S	Delivery/Express(125cc)	125	2004		F	
S	303RHawk/Laser (150cc)	150	2004	2008	F		
S	303RHawk/Laser (150cc)	150	2009		F		
S	404Executive	404	2003	2004	F		

M = MOTORCYCLE
S = SCOOTER
A = ATV
Sn = SNOWMOBILE

FDB386

66.0 x 56.0 x 8.8 mm

MATERIAL AVAILABILITY											
AG	EF	P	PRP	ST	SM	SG	ZR	XRAC	ZRAC	CP1	CPRO
	✓	✓		✓							

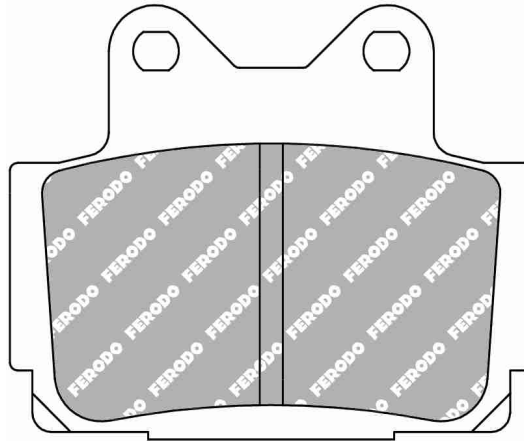

CROSS REFERENCE	
BRAKING	679
BREMBO	07YA12
CL BRAKES	2301
EBC	FA104
GALFER	FD069
GOLD FREN	067
LUCAS/TRW	MCB541
NEWFREN	FD0082
SBS	570
VESRAH	VD-240

		CC	KW	FROM	TO	FRONT REAR	LEFT RIGHT
	M FZR 50	50		1990	1991	R	
	M TZR 80	80			1991	F	
	M 125 BIKAN	125		1991		F	
	M RD 125 LC R	125		1985	1987	F	
	M TZR 125	125		1987	1989	F	
	M TZR 125	125		1990	1992	R	
	M SDR 200	200		1987	1989	F	
	M SDR 200	200		1987	1989	R	
	M FZR 250	250		1986	1988	R	
	M FZR 250 R	250		1989		R	
	M FZX 250 ZEAL	250		1991		R	
	M R1 250 Z	250		1997		R	
	M RZR 250	250		1990		F	
	M RZR 250	250		1990		R	
	M TDR 250	250		1988	1992	R	
	M TZ 250	250		1985	1988	R	
	M TZR 250	250		1985	1989	R	
	M TZR 250 R - SP	250		1989	1992	R	

		CC	KW	FROM	TO	FRONT REAR	LEFT RIGHT
	M RD 350 all models	350		1985	1995	F	
	M RD 350 all models	350		1985	1995	R	
	M FZ 400	400		1986		R	
	M FZR 400 RR - SP	400		1991	1992	R	
	M SRX 400	400		1985	1986	R	
	M SRX 400	400		1987	1989	R	
	M XJ 400 DIVERSION - R	400		1991	1994	R	
	M RD 500 LC	500		1984	1986	R	
	M RD 500 YPVS LC	500		1984	1987	R	
	M 600 DIVERSION	600		1992	1997	R	
	M FZ 600	600		1987	1988	R	
	M FZS 600 FAZER	600		1999	2003	R	
	M SRX 600	600		1985	1987	F	
	M SRX 600	600		1985	1987	R	
	M SRX 600	600		1988	1990	R	
	M XJ 600 S	600		1992	1997	R	
M XJ 600 S	600		1998	2003	R		

FDB389

58.0 x 54.0 x 8.7 mm

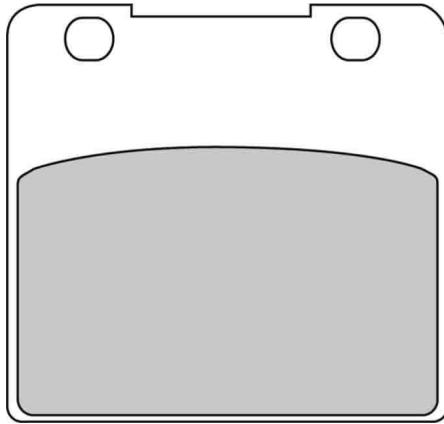

MATERIAL AVAILABILITY											
AG	EF	P	PRP	ST	SM	SG	ZR	XRAC	ZRAC	CP1	CPRO
		✓		✓							

CROSS REFERENCE	
BRAKING	680
BREMBO	07SU06
CL BRAKES	2280
EBC	FA103
GALFER	FD066
GALFER	FD078
LUCAS/TRW	MCB542
NEWFREN	FD0083
SBS	577
VESRAH	VD-331

		CC	KW	FROM	TO	FRONT / REAR	LEFT / RIGHT
	SUZUKI						
M	GSX-R 250	250		1987	1988	F	
M	GSX 400 X IMPULSE 400	400		1986	1988	F	
M	GSX-R 400 (III-IV)	400			1988	F	
M	RG 400 GAMMA	400		1985		F	
M	RG 500 RF GAMMA	500		1985	1987	F	
M	VS 600 GL INTRUDER	600		1997	1999	F	
M	VS 700 GL INTRUDER	700		1985		F	
M	GSX 750 LIMITED EDITION	750		1986		F	
M	GSX 750 EF	750		1987		F	
M	GSX-R 750 LTD Special Edition	750		1987	1988	F	
M	GT 750 RF	750		1985	1986	F	
M	VS 750 INTRUDER (All Models)	750		1985	1991	F	
M	VS 800 GL INTRUDER (VS52B)	800		1992	1999	F	

		CC	KW	FROM	TO	FRONT / REAR	LEFT / RIGHT
							
M	GSX 1100 E - EF - ES	1100		1984	1986	F	
M	GSX 1100 E - EF - ES	1100		1984	1986	R	
M	GSX-R 1100	1100		1985	1988	F	
M	GV 1400 GD	1400		1985	1986	F	
M	GV 1400 GD	1400		1985	1986	R	
M	GV 1400	1400		1985	1986	F	
M	VS 1400 Intruder (VX51L)	1400		1987	1995	F	
M	VS 1400 Intruder (VX51L)	1400		1987	1995	R	
M	VS 1400 GLP Intruder (VX51L/T)	1400		1996	2003	F	
M	VS 1400 GLP Intruder (VX51L/T)	1400		1996	2003	R	
M	VL 1500	1500		1998	2001	F	
M	VL 1500	1500		1998	2001	R	

M = MOTORCYCLE
S = SCOOTER
A = ATV
Sn = SNOWMOBILE

FDB390

58.0 x 47.9 x 8.8 mm

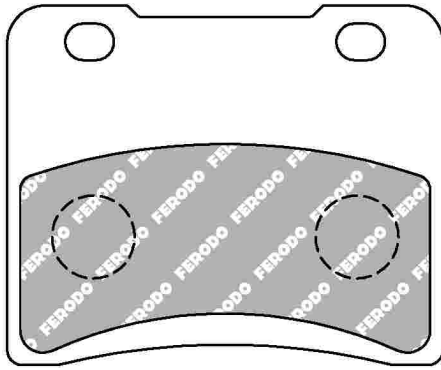

MATERIAL AVAILABILITY											
AG	EF	P	PRP	ST	SM	SG	ZR	XRAC	ZRAC	CP1	CPRO
		✓									

CROSS REFERENCE	
BREMBO	07SU07
EBC	FA102
GALFER	FD083
LUCAS/TRW	MCB547
NEWFREN	FD0119
SBS	578
VESRAH	VD-328

		CC	KW	FROM	TO	FRONT / REAR	LEFT / RIGHT
SUZUKI	M GF 250 S	250		1986		F	
	M RG 250 W GAMMA	250		1984	1987	F	

		CC	KW	FROM	TO	FRONT / REAR	LEFT / RIGHT
M	GSX 400 R I/II	400		1985	1986	F	
	GSX-R 400 (JAPAN)	400		1985		R	

FDB404

77.0 x 54.0 x 7.1 mm

MATERIAL AVAILABILITY											
AG	EF	P	PRP	ST	SM	SG	ZR	XRAC	ZRAC	CP1	CPRO
		✓									

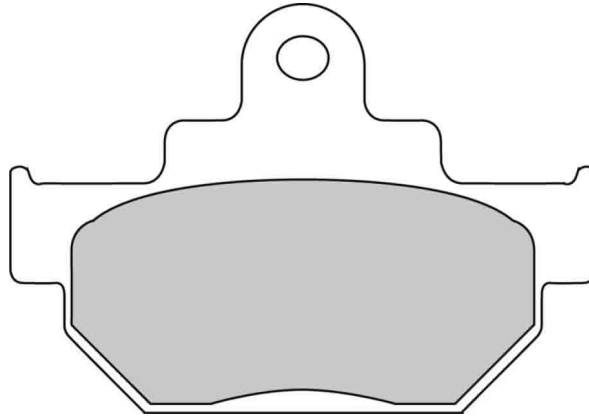

ALSO AVAILABLE		
SHAPE	TH. MM	NOTES
FDB673	9.4	

CROSS REFERENCE	
BRAKING	817
BREMBO	07SU09
CL BRAKES	2387
EBC	FA106
GALFER	FD209
GOLD FREN	030
LUCAS/TRW	MCB550
NEWFREN	FD0092
SBS	581
VESRAH	VD-329
VESRAH	VD-392/2

		CC	KW	FROM	TO	FRONT REAR	LEFT RIGHT
	MAICO						
	M 250 CROSS	250		1986		F	
	M 250 CROSS	250		1986		R	
	M 250 ENDURO	250		1986		F	
	M 250 ENDURO	250		1986		R	
	M GP 250	250		1987		F	
	M GP 250	250		1987		R	
	M GP 400	400		1987		F	
	M GP 400	400		1987		R	
	M 500 CROSS	500		1986		F	
	M 500 CROSS	500		1986		R	
	M 500 ENDURO	500		1986		F	
	M 500 ENDURO	500		1986		R	
	M GP 500	500		1987		F	
	M GP 500	500		1987		R	

		CC	KW	FROM	TO	FRONT REAR	LEFT RIGHT
							
	M GPE 500	500		1987		F	
	M GPE 500	500		1987		R	
	SUZUKI						
	M GZ 125 MARAUDER	125		1998	2011	F	
	M RM 125 F - G	125		1985	1986	F	
	M VL 125 INTRUDER	125		2000		F	
	M AN 150	150		1997	2000	F	
	M GZ 250 MARAUDER	250		2000		F	
	M RM 250 F - IG - G	250		1985	1986	F	
	M TU 250 X	250		1997	2000	F	
	M VL 250 INTRUDER	250		2000	2001	F	
	M VOLTY 250	250		1995	2000	F	
	M RM 500 F	500		1985	1986	F	
	M LS 650 SAVAGE	650		1987	1999	F	

M = MOTORCYCLE
S = SCOOTER
A = ATV
Sn = SNOWMOBILE

FDB411

91.0 x 30.0 x 8.4 mm

MATERIAL AVAILABILITY											
AG	EF	P	PRP	ST	SM	SG	ZR	XRAC	ZRAC	CP1	CPRO
		✓									

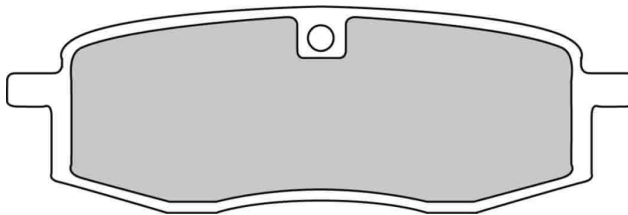

CROSS REFERENCE	
BRAKING	687
BREMBO	07YA13
CL BRAKES	2792
EBC	FA105
GALFER	FD080
NEWFREN	FD0089
SBS	580
VESRAH	VD-241

		CC	KW	FROM	TO	FRONT / REAR	LEFT / RIGHT
 YAMAHA	M	YZ 125	125	1985	1987	F	
	M	YZ 125	125	1988		F	
	M	TT 250 S	250	1987	1992	F	
	M	YZ 250	250	1985	1987	F	
	M	YZ 250	250	1988		F	

		CC	KW	FROM	TO	FRONT / REAR	LEFT / RIGHT
 	M	TT 350	350	1986	1990	F	
	M	TT 350	350	1991	1995	F	
	M	YZ 490	490	1985	1987	F	
	M	TT 600 N	600	1985	2000	F	

FDB436

31.5 x 52.0 x 5.5 mm

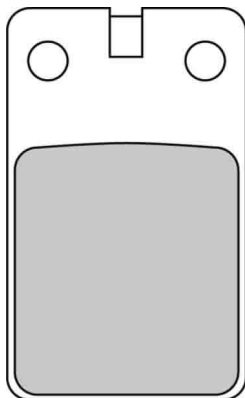



MATERIAL AVAILABILITY											
AG	EF	P	PRP	ST	SM	SG	ZR	XRAC	ZRAC	CP1	CPR0
		✓									







Pinze / Calipers

Grimeca

2-Piston, Twin Pin: 1005T

CROSS REFERENCE	
BRAKING	671
BREMBO	07.008
BRENTA	3013
BRENTA	4013
CL BRAKES	3034
EBC	FA099
GALFER	FD071
LUCAS/TRW	MCB564
NEWFREN	FD0074
SBS	595
VESRAH	VD-932

		CC	KW	FROM	TO	FRONT REAR	LEFT RIGHT
	BENELLI	M	DEVIL 50	50	1992	R	
	M	MASTER 4 50	50	1995	F		
	M	SPRING 50	50	1992	R		
	BETA	M	DEVIL 80	80	1995	R	
	M	ALP 50	50	1991	F		
	M	FOUR 50 S	50	1987	F		
	M	FOUR 50 AE	50	1987	F		
	M	FOUR TWIN 50	50	1988	F		
	M	TR 32 125	125	1986	F		
	M	TR 33 125	125	1987	F		
	M	TR 34 125	125	1988	F		
	M	ALP 240	240	1991	1995	F	
	M	TR 33 240	240	1986	1988	F	
	M	TR 33 TREKKING 240	240	1988	F		
	M	TR 34 250	250	1986	1988	F	
	M	TR 34 250 (SPAIN)	250	1989	F		
	M	TR 34 250 (SPAIN)	250	1989	R		
	M	TR 34 250 PROFESSIONAL	250	1989	F		
M	ALP 260	260	1990	F			
M	TR 34 260	260	1987	1988	F		
M	TR 35 260	260	1989	1991	F		
	CIMATTI	M	Gringo 50	50	1985	F	
	FANTIC	M	TRIAL 50 .1 (FM.268)	50	1986	F	
M	TRIAL 50 .1 H2O	50	1987	F			
M	TRIAL 125 .1 Progress 2	125	1986	F			
M	TRIAL 125 .1 Progress 1	125	1986	1986	F		
M	TRIAL 125 .3 PROFESSIONAL (FM 361)	125	1987	F			
M	TRIAL 125 .3 PROFESSIONAL (FM 361)	125	1987	R			
M	TRIAL 200 Progress 1	200	1986	F			
M	TRIAL 201 Progress2	201	1986	F			
M	TRIAL 240 (FM 363)	240	1987	F			
M	TRIAL 240 (FM 363)	240	1987	R			
M	TRIAL 241 PROFESSIONAL	241	1986	F			

		CC	KW	FROM	TO	FRONT REAR	LEFT RIGHT
	M	TRIAL 301 Progress 1 (FM. 266)	301	1985	F		
	M	TRIAL 301 Progress 2	301	1986	F		
	M	TRIAL 303 (FM 364)	303	1987	F		
	M	TRIAL 303 (FM 364)	303	1987	R		
	GARELLI	M	TIGER 50 XLE	50	1986	R	
	GASGAS	M	HALLEY 325 PCX	325	1987	F	
	M	HALLEY 325 PCX	325	1987	R		
	GILERA	M	503 50	50	1991	F	
	M	503 50	50	1991	R		
	M	BULLIT 50	50	1990	F		
	MALAGUTI	M	CR1 50 CROSSER	50	1995	F	
	M	DUNE 50 ENDURO	50	1987	F		
	M	DUNE 50 ENDURO	50	1987	R		
	M	F 12 50 PHANTOM (liquid cooled)	50	1995	1997	F	
	M	F 15 50 FIREFOX	50	1996	1997	F	
	M	FIFTY 50 FULL (all models)	50	1983	F		
	M	FIFTY 50 TOP	50	1985	F		
	M	Mopeds 50 (all models)	50		1983	F	
	M	MR4 50 ENDURO	50	1987	F		
	M	MR4 50 ENDURO	50	1987	R		
	M	RCX-W 50 ENDURO	50	1983	F		
	M	RGT 50 STRADA	50	1983	F		
	M	RGT 50 SPORT	50	1985	F		
	M	RST 50 SPORT tutti i tipi	50	1987	F		
	M	RST 50 SPORT tutti i tipi	50	1987	R		
	M	SAHIB 50 ENDURO	50	1983	F		
	MONTESA	M	MKS 50	50	1987	F	
	M	COTA 304	304	1987	F		
	TOMOS	M	N 50 AT BT	50	1991	2000	F
	TRE SOLDI	M	CR 80	80	1985	R	
	ZUNDAPP	M	KS 80 TOURING K	80	1982	F	
	M	KS 80 TOURING L	80	1982	F		

M = MOTORCYCLE
S = SCOOTER
A = ATV
Sn = SNOWMOBILE

FDB437

53.0 x 44.0 x 7.0 mm

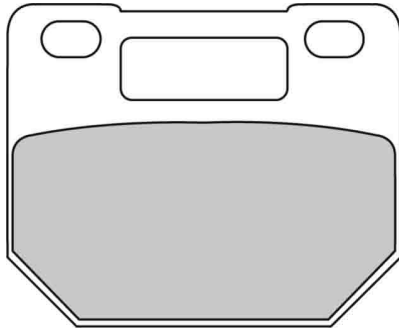

MATERIAL AVAILABILITY											
AG	EF	P	PRP	ST	SM	SG	ZR	XRAC	ZRAC	CP1	CPRO
		✓									

CROSS REFERENCE	
BREMBO	07SU10
BRENTA	3134
BRENTA	4134
EBC	FA110
GALFER	FD081
LUCAS/TRW	MCB556
NEWFREN	FD0100
SBS	587
VESRAH	VD-335

		CC	KW	FROM	TO	FRONT REAR	LEFT RIGHT
	M RG 80 GAMMA	80		1988	1993	F	

		CC	KW	FROM	TO	FRONT REAR	LEFT RIGHT
	M RG 125 W GAMMA	125		1985	1991	F	

FDB438

79.0 x 47.0 x 7.4 mm

July 2016: AG compound superseded by EF

MATERIAL AVAILABILITY											
AG	EF	P	PRP	ST	SM	SG	ZR	XRAC	ZRAC	CP1	CPR0
✗	✓	✓									

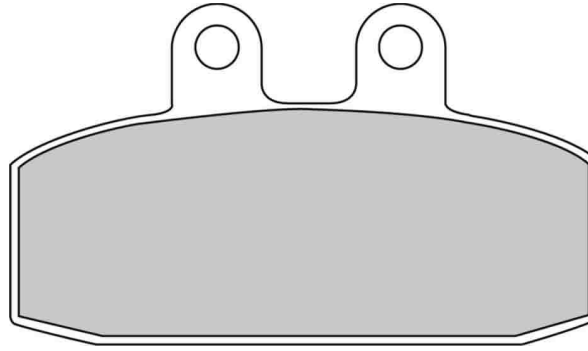

ALSO AVAILABLE		
SHAPE	TH. MM	NOTES
FDB2060		Material swept depth different

CROSS REFERENCE	
BRAKING	684
BREMBO	07006
BREMBO	7006
BRENTA	3026
BRENTA	4026
CL BRAKES	2794
EBC	FA256
EBC	Old FA113
GALFER	FD074
LUCAS/TRW	MCB557
NEWFREN	FD0091
SBS	108
SBS	588
VESRAH	VD-152

		CC	KW	FROM	TO	FRONT REAR	LEFT RIGHT
	M TUAREG 50 HPC SYSTEM	50		1987		F	
	M ETX 125	125		1986	1997	F	
	M RED ROSE 125	125		1989	1989	F	
	M RX 125	125		1985	1989	F	
	S SCARABEO 125	125		1998	2006	F	
	S SCARABEO 125 GT	125		2002	2003	F	
	M SPORTCITY 125 ie	125		2004		F	
	M TUAREG 125 RALLY	125		1986		F	
	M TUAREG 125 RALLY (Mozzi Rimoldi)	125		1986		F	
	M TUAREG 125	125		1986		F	
	M TUAREG 125	125		1987		F	
	S SCARABEO 150	150		1998		F	
	S SCARABEO 200	200		2001	2007	F	
	S SCARABEO 200 GT	200		2002		F	
	M SPORTCITY 200	200		2004		F	
	M LEONARDO 250	250		1999		F	
	M SPORTCITY 250 ie	250		2007		F	
	M TUAREG 250 RALLY (Mozzi Rimoldi)	250		1986		F	
	M TUAREG 250 RALLY	250		1986		F	
	M LEONARDO 300	300		2004		F	
M SPORTCITY 300 / Cube Black line	300		2008		F		
M ETX 350	350		1986		F		
M ETX 350 AE	350		1987		F		
M TUAREG 350	350		1987		F		
M TUAREG 350 WIND	350		1987	1988	F		
S SCARABEO 400 ie	400		2007		F		

		CC	KW	FROM	TO	FRONT REAR	LEFT RIGHT	
	S ATLANTIC (ARECIFE) 500	500		2001		F	left	
	S SCARABEO 500	500		2008		F		
	S SCARABEO 500 Class	500		2010		F		
	M ETX 600	600		1986		F		
	CAGIVA	M BLUES 50	50		1989		F	
		M MITO 50	50		1998		F	
		M BLUES 125	125		1988	1992	F	
		M BLUES 125	125		1993		F	
		M ROADSTER 125	125		1994		F	
		M ROADSTER 200	200		1996		F	
	M ALA AZZURRA 650 GT	650		1987		F		
	FANTIC	M RAIDER 250 (FM. 259)	250		1985		F	
		M TIGER 125 XLE	125		1986	1986	F	
	GARELLI	M EC ROOKIE 50	50		2001		F	
		M CROSS 125	125		1994		R	
	GILERA	M TT 125 ENDURCROSS	125		1993		R	
		M ARIZONA HAWK 125	125		1986		F	
		M CMM APTS 125	125		1987		F	
		M ER 125	125		1987		F	
		M FAST BIKE 125	125		1987		F	
M KK 125 APTS		125		1987		F		
M KZ 125		125		1986		F		
M KZ 125 ENDURANCE		125		1988		F		
M R1 125 S		125		1988		F		
M RC 125 RALLY		125		1987		F		
M RRT 125 NEBRASKA (tubeless tires)	125		1987	2000	F			

M = MOTORCYCLE
S = SCOOTER
A = ATV
Sn = SNOWMOBILE



		CC	KW	FROM	TO	FRONT / REAR	LEFT / RIGHT
	M RRT 125 NEBRASKA	125		1987		F	
	M RTX 125	125				F	
	M RV 125 ES	125		1987		F	
	M XR1 125	125		1988		F	
	M XR2 125	125		1989		F	
	M ARIZONA HAWK 200	200		1986		F	
	M ER 200	200		1987		F	
	M FAST BIKE 200	200		1987		F	
	M RTX 200	200		1986		F	
	M RV 200 ES	200		1987		F	
	M RC 250 RALLY	250		1987		F	
	M DAKOTA 350	350		1986		F	
	M ER 350	350		1987		F	
	M XRT 350	350		1990		F	
	M DAKOTA 500	500		1987		F	
	M ER 500	500		1987		F	
	M XRT 600	600		1988		F	
HONDA	M CLR 125 CITY FLY	125		1998	2003	F	
	M CRM 125 (Italy)	125		1990	1999	F	
	M MTX 125 R	125		1987	1988	F	
	M MTX 125 RII	125		1989		F	
	M NS 125 F	125		1985	1987	F	
	M NS 125 R	125		1987	1990	F	
	M NSR 125 R - F	125		1988	1990	F	
	M NSR 125 FII	125		1991	1993	F	
	M NSR 125 R	125		1991	2001	F	
	M NSR 125 F RAIDEN	125		1994	1996	F	
	M NX 125 (ITALY)	125		1990		F	



		CC	KW	FROM	TO	FRONT / REAR	LEFT / RIGHT
	M XL 125 R	125		1987	1988	F	
	M XL 125 PARIS DAKAR	125		1989		F	
	M XL 125 L PARIS DAKAR	125		1989		F	
	M MTX 200 R	200		1987		F	
	M XL 200 R	200		1985		F	
HONDA-HM ITALIA	M DT 125	125		1987		F	
	M MTX 125 R	125		1986		F	
	M MTX 125 RALLY SPORT	125		1988		F	
	M NS 125 F	125		1985		F	
	M NS 125 R SUPER SPORT	125		1987		F	
	M NSR 125 R	125		1989		F	
	M XL 125 L PARIS DAKAR	125		1985		F	
	M XL 125 R2	125		1987		F	
	M XL 200 L	200		1985		F	
	M XL 200 L PARIS DAKAR	200		1987		F	
	M XL 200 R2	200		1987		F	
MALAGUTI	M SPIDER MAX RS 500/ GT	500		2004		F	
MOTO MORINI	M CAMEL 501	50		1987		F	
	M EXCALIBUR 501	50		1986	1986	F	
	M EXCALIBUR 501	50		1987	1988	F	
	M BLUES 125	125		1993		F	
	M EXCALIBUR 350	350		1986	1989	F	
	M KANGURO 350	350		1987		F	
MOTORHISPANIA	M RX 50 RACING	50		2000		F	
PUCH	M 125	125		1987		F	
YAMAHA	M DT 125 (Italia)	125		1986	1987	F	
	M DT 125 TENERE (Italia)	125		1987		F	

FDB449

74.9 x 54.8 x 10.7 mm

MATERIAL AVAILABILITY											
AG	EF	P	PRP	ST	SM	SG	ZR	XRAC	ZRAC	CP1	CPRO
		✓		✓							

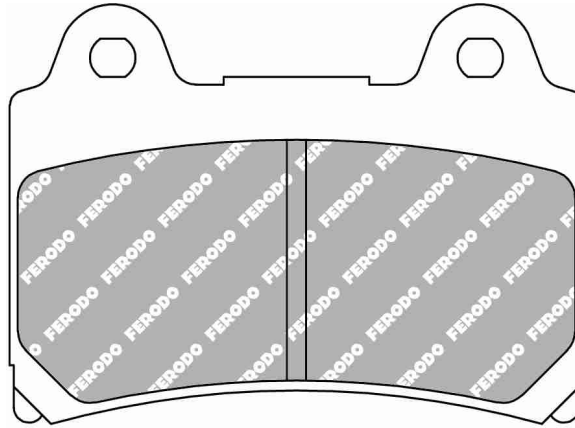

ALSO AVAILABLE		
SHAPE	TH. MM	NOTES
FDB662	8.8	

Pinze / Calipers

FLORIDA Caliper

4-Piston (Th. 10.7mm)

CROSS REFERENCE	
BREMBO	07YA17
BRENTA	4135
CL BRAKES	2305
CL BRAKES	2311
EBC	FA123
LUCAS/TRW	MCB559
NEWFREN	FD0104
SBS	590
VESRAH	VD-242
VESRAH	VD-242/2

		CC	KW	FROM	TO	FRONT REAR	LEFT RIGHT
	YAMAHA	M	FZR 250	250	1986	1988	F
		M	R1 250 Z	250	1997		F
		M	TDR 250	250	1988	1992	F
		M	TZ 250	250	1985	1988	F
		M	TZR 250	250	1985	1989	F
		M	FZR 400 R	400	1987	1990	F
		M	SRX 400	400	1987	1989	F
		M	SRX 600	600	1988	1990	F
		M	FZ 750 GENESIS	750	1989	1992	F

		CC	KW	FROM	TO	FRONT REAR	LEFT RIGHT
		M	FZR 750 GENESIS	750	1987		F
		M	TDM 850	850	1991	1995	F
		M	TRX 850	850	1995	1999	F
		M	FZR 1000 GENESIS - EX-UP	1000	1986	1988	F
		M	FJ 1200 W - WC	1200	1989	1991	F
		M	XVZ 1300 AH/ATH ROYAL STAR	1300	1996	2001	R
		M	XVZ 1300 TF VENTURE STAR	1300	1999	2001	R
		M	XV 1600 A WILD STAR	1600	1999		R

M = MOTORCYCLE
S = SCOOTER
A = ATV
Sn = SNOWMOBILE

FDB452

88.1 x 46.1 x 8.5 mm

MATERIAL AVAILABILITY											
AG	EF	P	PRP	ST	SM	SG	ZR	XRAC	ZRAC	CP1	CPRO
		✓		✓							

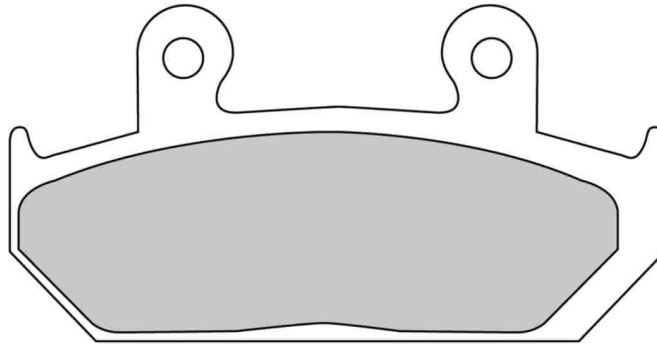

ALSO AVAILABLE		
SHAPE	TH. MM	NOTES
FDB663	9.8	
FDB2173	8.5	pin on the backplate

CROSS REFERENCE	
BREMBO	07HO23
BRENTA	3104
BRENTA	3143
BRENTA	4104
BRENTA	4143
CL BRAKES	2310
EBC	FA124
GALFER	FD401
LUCAS/TRW	MCB571
NEWFREN	FD0188
SBS	600
VESRAH	VD-143

		CC	KW	FROM	TO	FRONT / REAR	LEFT / RIGHT
	HONDA						
	M	RS 125 R	125	1987	1990	F	
	M	CB 250	250	1988	1991	F	
	M	VTZ 250	250	1988		F	
M	TRANSALP 400	400	1992		F		

		CC	KW	FROM	TO	FRONT / REAR	LEFT / RIGHT
	M	NX 650 DOMINATOR	650	1993	1994	F	
	M	VFR 700 F/F2 INTERCEPTOR	700	1986	1987	F	
	M	CBR 1000 F	1000	1987	1988	F	
	M	CBR 1000 R HURRICANE	1000	1987	1988	F	

FDB462

81.2 x 42.0 x 8.0 mm

MATERIAL AVAILABILITY											
AG	EF	P	PRP	ST	SM	SG	ZR	XRAC	ZRAC	CP1	CPRO
		✓		✓							

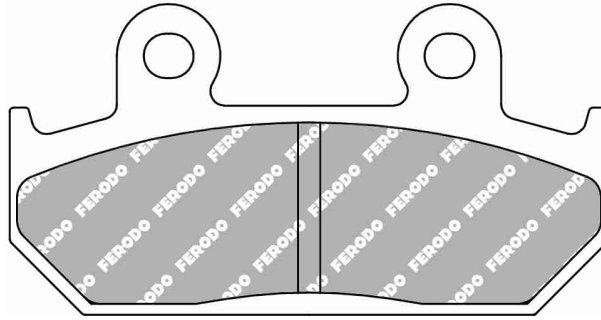

ALSO AVAILABLE		
SHAPE	TH. MM	NOTES
FDB2113	9.5	

CROSS REFERENCE	
BRAKING	704
BREMBO	07HO21
CL BRAKES	2252
EBC	FA121
GALFER	FD096
GOLD FREN	025
LUCAS/TRW	MCB562
NEWFREN	FD0106
SBS	593
VESRAH	VD-141
VESRAH	VD-142

		CC	KW	FROM	TO	FRONT / REAR	LEFT / RIGHT
 HONDA	M CBR 250 F	250		2004		F	
	M CBR 250 R HURRICANE	250		1986	1988	F	
	M NSR 250	250		1986		F	
	M NSR 250 R	250		1986	1987	F	
	M VT 250 F INTEGRA	250		1987		F	
	M CB 350 SG	350		1986		F	
	M CBR 400 RH-YA (NC23) 101	400		1986	1986	F	
	M CBR 400 RG (NC23) 100	400		1986	1986	F	

		CC	KW	FROM	TO	FRONT / REAR	LEFT / RIGHT
 HONDA	M VFR 400 R	400		1986	1987	F	
	M VFR 400 R	400		1987	1989	F	
	M CBX 450 S	450		1987		F	
	M CBR 500	500		1987	1990	F	
	M CBR 600 F/R HURRICANE	600		1987	1990	F	
	M XRV 750 AFRICA TWIN (RD04)	750	37	1990	1993	F	
	M XRV 750 AFRICA TWIN (RD04)	750	43	1990	1993	F	

M = MOTORCYCLE
S = SCOOTER
A = ATV
Sn = SNOWMOBILE

FDB475

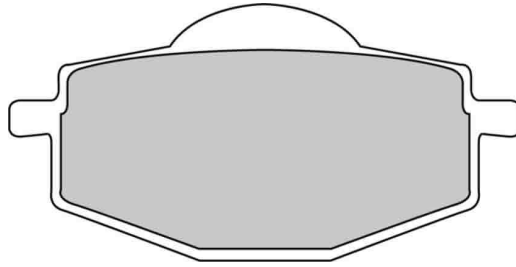

71.0 x 36.0 x 8.0 mm

MATERIAL AVAILABILITY											
AG	EF	P	PRP	ST	SM	SG	ZR	XRAC	ZRAC	CP1	CPRO
✓											



ALSO AVAILABLE		
SHAPE	TH. MM	NOTES
FDB383	9.4	

CROSS REFERENCE	
BREMBO	07YA14
CL BRAKES	2284
EBC	FA101
GALFER	FD079
LUCAS/TRW	MCB539
NEWFREN	FD0090
SBS	575
VESRAH	VD-239
VESRAH	VD-239/2

		CC	KW	FROM	TO	FRONT / REAR	LEFT / RIGHT
	HONDA-HM ITALIA						
	M CRE 50 (up to frame nr.1000)	50				R	
	YAMAHA						
	M YSR 50	50		1986	1987	F	
	M YSR 60	60		1986	1987	F	
	M DT 80 LC - LC II - N	80		1985		F	
	M TDR 80	80		1989		F	
	M TDR 80	80		1989		R	
	M YSR 80	80		1986		F	
	M DT 125 LC - R	125		1985	1986	F	
	M DT 125 LC / R	125		1988		F	

		CC	KW	FROM	TO	FRONT / REAR	LEFT / RIGHT
	HONDA						
	M TDR 125 R	125		1993	2003	R	
	M XC 125 TR CYGNUS R	125		1998	2003	F	
	M RT 180 G	180		1995	2000	F	
	M DT 200 R	200		1988	1991	F	
	M DT 200 R	200		1988	1991	R	
	M XT 350 4 VALVES	350		1986	1987	F	
	M TT 600	600		1987	1992	F	
	M XT 600 4 VALVES	600		1987	1989	R	
	M XT 600 Z TENERE	600		1988	1990	R	

FDB481

95.0 x 35.0 x 8.8 mm / 141.0 x 42.0 x 8.3 mm

MATERIAL AVAILABILITY

AG	EF	P	PRP	ST	SM	SG	ZR	XRAC	ZRAC	CP1	CPR0
	✓	✓		✓							

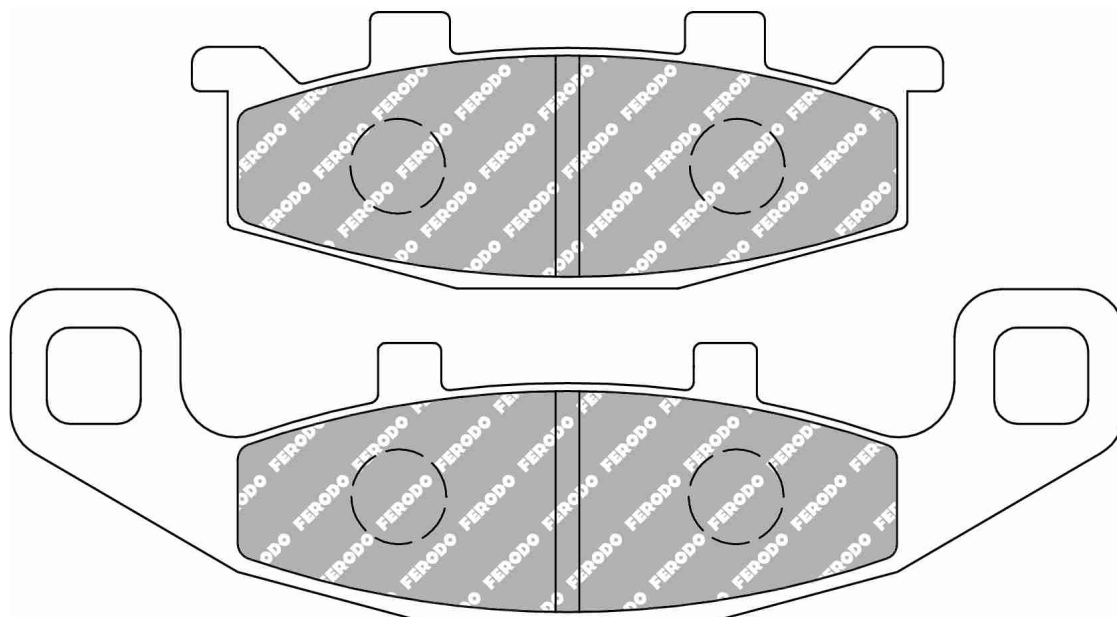

CROSS REFERENCE

BRAKING	698
BREMBO	07KA09
CL BRAKES	2304
EBC	FA129
GALFER	FD090
GOLD FREN	013
LUCAS/TRW	MCB569
NEWFREN	FD0108
SBS	597
VESRAH	VD-427

		CC	KW	FROM TO		FRONT REAR	LEFT RIGHT
	KAWASAKI						
M	EX 250 H1 - H2	250		1990		F	
M	GPX 250 R NINJA	250		1987	1995	F	
M	KDX 250 BALIUS	250		1991	1993	F	
M	KLE 250 ANHELO	250		1993	1999	F	
M	KLE 250 ANHELO	250		2000	2002	F	
M	KR-1 250	250		1988		F	
M	ZZR 250 (EX 250 H)	250		1990	1993	F	
M	EX 4 400	400		1995		F	
M	GPX 400 R	400		1987		R	
M	GPZ 400 R	400		1990		R	
M	KLE 400	400		1991		F	
M	ZL 400 ELIMINATOR	400		1993		F	
M	ZR 400 ZEPHYR	400		1993	1995	F	
M	ZR 400 ZEPHYR (ZR-C)	400		1989	1992	F	
M	ZXR 400	400		1994		F	
M	ZZR 400	400		1990	1992	R	
M	ER-5 500 (ER)	500		1997	2000	F	
M	EX 500 all models	500		1987	1991	F	
M	GPZ 500 S	500		1993		R	
M	GPZ 500 S	500		1994	1997	F	
M	KLE 500	500		1991		F	
M	ZZ-R 500	500		1990		R	
M	ZEPHYR 550	550		1991		F	
S	ZR 550 ZEPHYR	550		1990	1992	F	
S	ZR 550 ZEPHYR	550		1993	1999	F	
S	GPX 600 R (ZX)	600		1988	1996	F	
S	GPX 600 R (ZX)	600		1988	1996	R	
M	GPX 600 R WARBIRD	600		1988	1996	F	
M	GPX 600 R WARBIRD	600		1988	1996	R	
M	KLE 600	600		1992		F	
M	ZL 600 B1 ELIMINATOR	600		1995	1997	F	

		CC	KW	FROM TO		FRONT REAR	LEFT RIGHT
							
M	ZX 6R 600 D1-D2 (DX 6)	600		1990	1993	R	
M	ZZR 600	600		1990	1992	R	
M	KL 650 TENGAI	650		1989	1992	F	
M	GPX 750 BLACKBIRD	750		1988	1989	F	
M	GPX 750 BLACKBIRD	750		1988	1989	R	
M	GPX 750 WARBIRD	750		1988	1989	F	
M	GPX 750 WARBIRD	750		1988	1989	R	
M	GPZ 750 R - G2-3	750		1987		F	
M	GPZ 750 R - G2-3	750		1987		R	
M	ZR 750	750		1991	1995	F	
M	ZR 750	750		1991	1995	R	
M	ZR 750 ZEPHYR	750		1991	1993	F	
M	ZR 750 ZEPHYR	750		1996		R	
M	ZX 750 F2 NINJA	750		1988		F	
M	ZX 750 F2 NINJA	750		1988		R	
M	GPZ 900 R	900		1990	1996	R	
M	GPX 1000 R	1000		1988	1990	F	
M	GPX 1000 R	1000		1988	1990	R	
M	Z 1000 GTR	1000		1994	2003	F	
M	ZX 1000 ELIMINATOR	1000		1988	1990	F	
M	ZX 1000 ELIMINATOR	1000		1988	1990	R	
M	ZX 1000 RX NINJA - TOMCAT	1000		1988	1990	F	
M	ZX 1000 RX NINJA - TOMCAT	1000		1988	1990	R	
M	ZX10 1000 TOMCAT B1-3	1000		1988	1990	F	
M	ZX10 1000 TOMCAT B1-3	1000		1988	1990	R	
M	ZZR 1000	1000		1991		R	
M	ZR 1100 ZEPHYR (ZR 1100 A)	1100		1992	1996	R	
M	ZR 1100 ZEPHYR	1100		1996	1997	R	
M	ZR 1100 ZEPHYR	1100		1997	2000	R	
M	ZX 1100	1100		1993		R	
M	ZZR 1100 GT (ZX 1100 C)	1100		1990	1992	R	

M = MOTORCYCLE
S = SCOOTER
A = ATV
Sn = SNOWMOBILE

		CC	KW	FROM	TO	FRONT / REAR	LEFT / RIGHT
	M ZRX 1200 R - S	1200		2000		F	
SUZUKI	M RG 125 U WOLF	125		1992	1994	F	
	M RG 200 WOLF	200		1993	1994	F	
	M ACROSS 250	250		1990		F	
	M 250 BANDIT	250		1990		F	
	M GSF 250 BANDIT	250		1990		F	
	M GSX 250 S KATANA	250		1991		F	

		CC	KW	FROM	TO	FRONT / REAR	LEFT / RIGHT
	M SW1 250	250		1992		F	
	M GSF 400 BANDIT	400		1991	1992	F	
	M GS 500 E - K - L - M	500		1989	1993	F	
	M DR 800 BIG all models	800		1991		F	
	M VX 800	800		1990	1994	F	
	M GSX 1100 GM	1100		1991	1992	F	
	M GSX 1100 G	1100		1993	1996	F	

FDB485

104.0 x 62.0 x 12.4 mm

December 2019: PRP superseded by P

MATERIAL AVAILABILITY											
AG	EF	P	PRP	ST	SM	SG	ZR	XRAC	ZRAC	CP1	CPR0
		✓	✗								

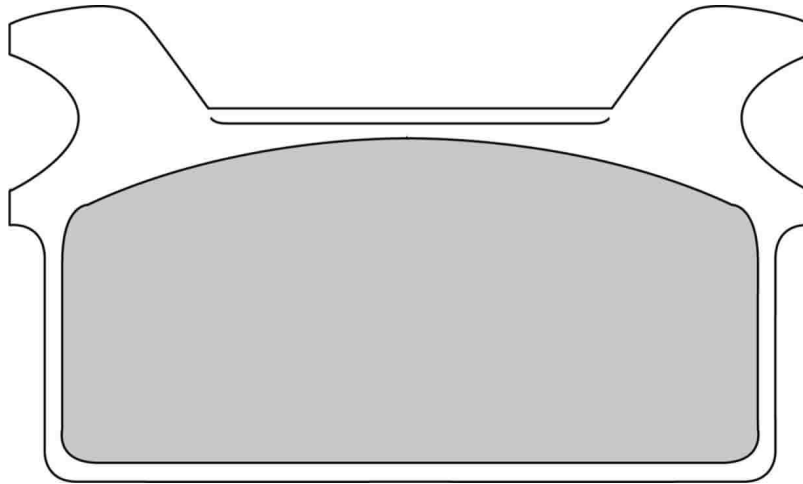

CROSS REFERENCE	
BREMBO	07HD09
CL BRAKES	2342
EBC	FA138
EBC	FA201
GALFER	FD125
NEWFREN	FD0149
SBS	609
VESRAH	VD-956

		CC	KW	FROM	TO	FRONT / REAR	LEFT / RIGHT
HARLEY DAVIDSON	M FLHR Road King (all models)	1340		1994	1999	R	
	M FLHS Electra Glide Sport	1340			1993	R	
	M FLHT Electra Glide (all models)	1340		1986	1999	R	
	M FLT Tour Glide (all models)	1340		1986	1999	R	
	M FLTR Road Glide (all models)	1340		1998	1999	R	

		CC	KW	FROM	TO	FRONT / REAR	LEFT / RIGHT
HONDA	M CB 100 N	100		1978		F	
	M CB 125 T	125		1978		F	
	M CB 125 J	125		1979		F	
	M CB 125 T2 - TA - TB	125		1979		F	

FDB494

73.0 x 49.0 x 6.6 mm / 61.0 x 63.0 x 8.9 mm

MATERIAL AVAILABILITY											
AG	EF	P	PRP	ST	SM	SG	ZR	XRAC	ZRAC	CP1	CPRO
		✓									

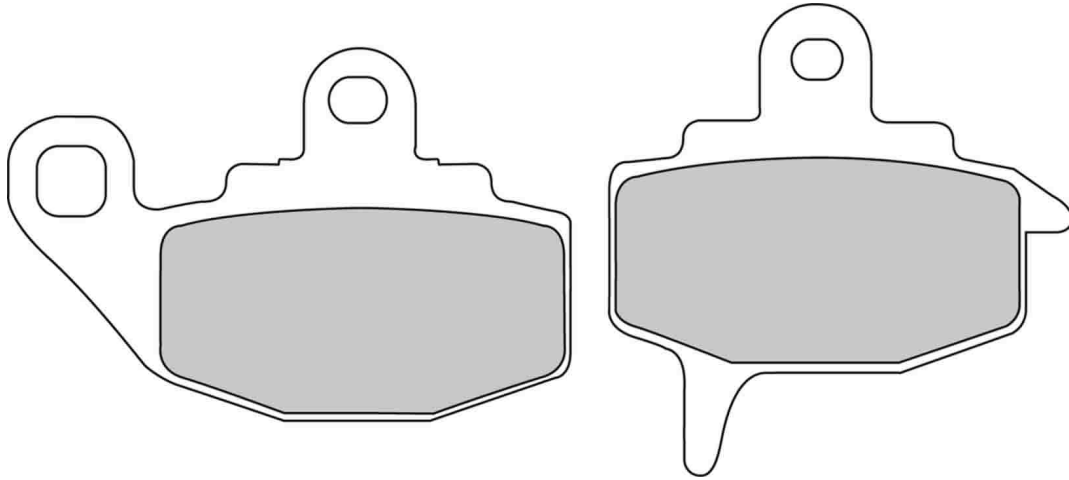

CROSS REFERENCE	
BREMBO	07KA10
EBC	FA130
GALFER	FD091
LUCAS/TRW	MCB573
NEWFREN	FD0116
SBS	602
VESRAH	VD-428

		CC	KW	FROM	TO	FRONT REAR	LEFT RIGHT
 KAWASAKI	M	KX 60 B9	60	1993	2004	F	
	M	KX 125 E2 - D1 - E2	125	1987	1988	F	
	M	KX 250 E1 - F1	250	1987	1988	F	

		CC	KW	FROM	TO	FRONT REAR	LEFT RIGHT
 KAWASAKI	M	KX 500 C1	500	1987	1988	F	
	M	KLR 650	650	1987	1994	F	

M = MOTORCYCLE
S = SCOOTER
A = ATV
Sn = SNOWMOBILE

FDB495

94.5 x 32.1 x 7.1 mm

MATERIAL AVAILABILITY											
AG	EF	P	PRP	ST	SM	SG	ZR	XRAC	ZRAC	CP1	CPRO
		✓				✓					

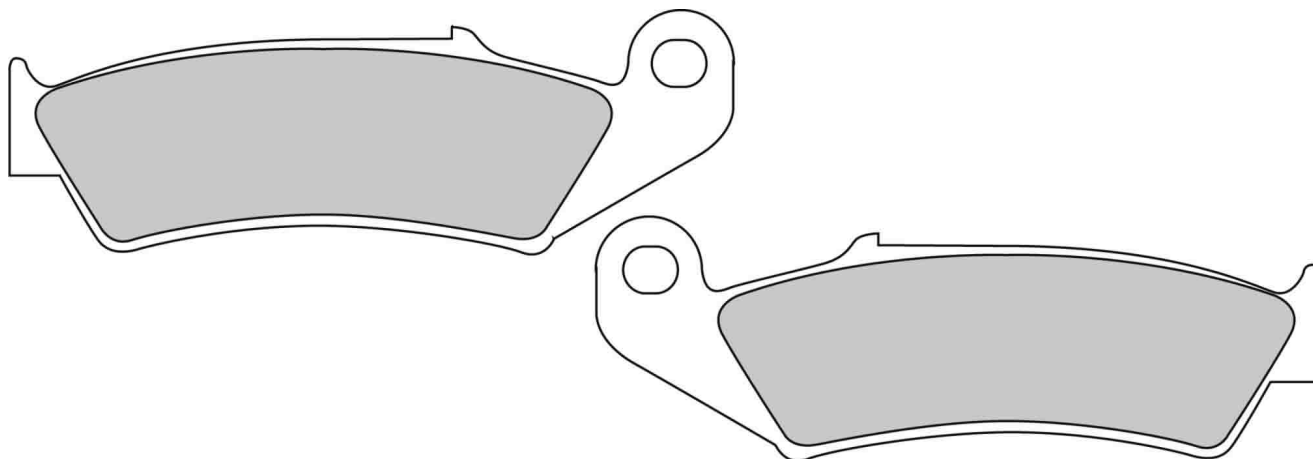

ALSO AVAILABLE		
SHAPE	TH. MM	NOTES
FDB496	10.5	

CROSS REFERENCE	
BRAKING	700
BREMBO	07HO25
BREMBO	07HO29
CL BRAKES	2300
CL BRAKES	2302
COBREQ	N-917
EBC	FA125
FRAS-LE	PD/860
GALFER	FD092
LUCAS/TRW	MCB574
LUCAS/TRW	MCB594
NEWFREN	FD0120
SBS	603
SBS	623
VESRAH	VD-139

		CC	KW	FROM	TO	FRONT / REAR	LEFT / RIGHT
	HONDA						
M	CRM 75	75		1990	1994	F	
M	CRM 75 R	75		1990	1994	F	
M	CR 125 RH - J - K - L	125		1987	1994	F	
M	CRM 125	125		1990	1999	F	
M	NX 125 TRANSCITY	125		1989	1997	F	
M	AX 1 250	250		1988		F	
M	CR 250 R	250		1987	1994	F	
M	CRM 250 R	250		1989	1990	F	
M	NX 250	250		1988	1990	F	
M	NX 250 DOMINATOR	250		1988	1990	F	
M	XL 250	250		1990	1990	F	

		CC	KW	FROM	TO	FRONT / REAR	LEFT / RIGHT
							
M	XL 250	250		1991		F	
M	XLR 250 R BAJA	250		1988	1990	F	
M	XR 250 R	250		1988	1993	F	
M	CR 500 R	500		1987	1992	F	
M	XR 600 R	600		1988	1990	F	
M	XR 600 R	600		1991	1993	F	
M	XR 650 L	650		1993	1995	F	
HONDA 3 WHEELERS	A	ATC 350 X	350	1987	2000	F	
HONDA ATV	A	TRX 250 R Fourtrax	250	1986	1989	F	
HONDA-HM ITALIA	M	CRE 260	260	1990		F	

FDB496

94.5 x 32.1 x 10.6 mm

MATERIAL AVAILABILITY											
AG	EF	P	PRP	ST	SM	SG	ZR	XRAC	ZRAC	CP1	CPRO
		✓									

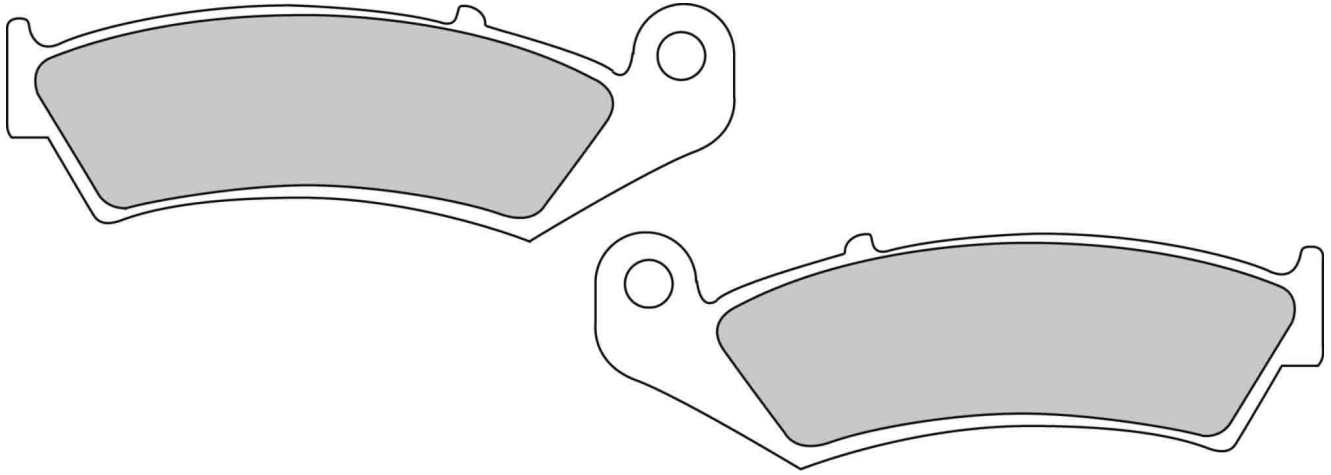

ALSO AVAILABLE		
SHAPE	TH. MM	NOTES
FDB495	7.0	

CROSS REFERENCE	
CL BRAKES	2385
DP (Dunlop) BRAKE	DP113
EBC	FA143
GALFER	FD110
NEWFREN	FD0141
VESRAH	VD-139/2

		CC	KW	FROM	TO	FRONT / REAR	LEFT / RIGHT
 HONDA	M	NSR 250 R SP	250	1994	1996	R	
	M	NSR 250 R SE	250	1994	1996	R	
	M	RVF 400	400	1994		R	
	M	VTR 400 R (NC 30)	400	1989	1991	R	

		CC	KW	FROM	TO	FRONT / REAR	LEFT / RIGHT
 KAWASAKI	M	NR 750	750	1992		R	
	M	RVF 750 RR (RC 45)	750	1994		R	
	M	VFR 750 R (RC-30)	750	1988	1993	R	
	M	ZXR 750 R STINGER / NINJA	750	1991	1992	R	

FDB497

96.8 x 42.2 x 7.6 mm / 76.5 x 42.2 x 7.6 mm

June 2017: AG superseded by EF

MATERIAL AVAILABILITY											
AG	EF	P	PRP	ST	SM	SG	ZR	XRAC	ZRAC	CP1	CPRO
X	✓	✓		✓	✓	✓					

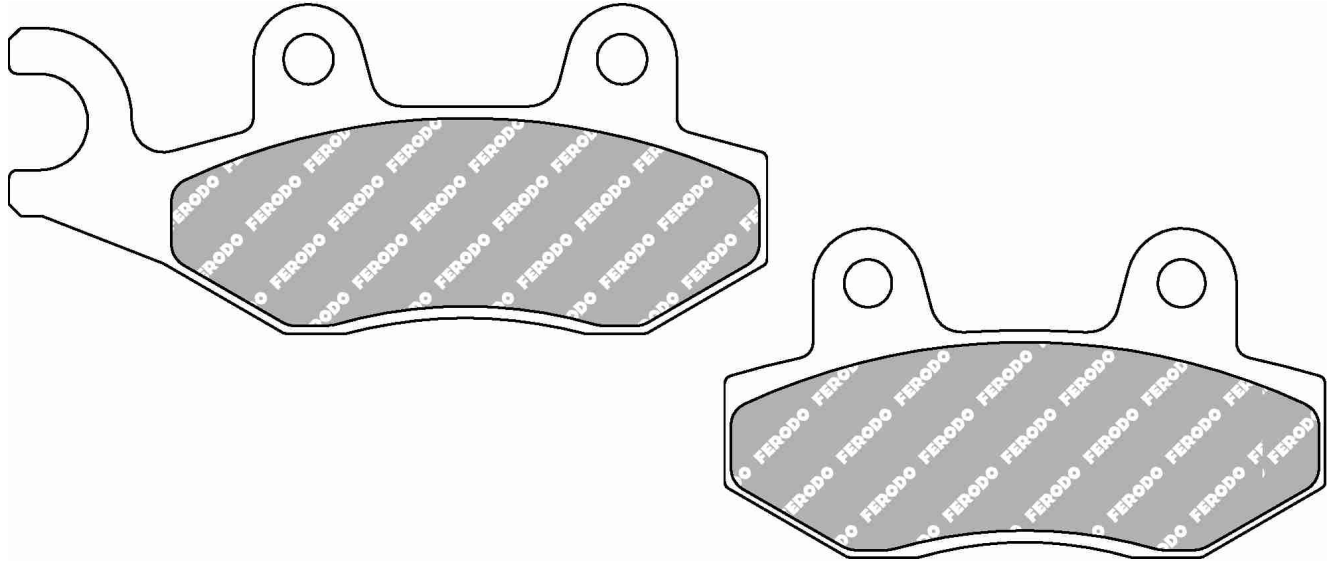

ALSO AVAILABLE		
SHAPE	TH. MM	NOTES
FDB631		Coupled set
FDB2305	9	

CROSS REFERENCE	
BRAKING	696
BRAKING	795
BREMBO	07035
BREMBO	07SU12
BREMBO	7035
BREMBO	7076
BRENTA	3063
BRENTA	3070
BRENTA	4063
BRENTA	4070
CL BRAKES	2288
CL BRAKES	3031
EBC	FA135
EBC	FA202
EBC	FA214
EBC	FA228
FRAS-LE	PD/865
GALFER	FD086
GOLD FREN	002
GOLD FREN	334
LUCAS/TRW	MCB582
NEWFREN	FD0122
SBS	163
SBS	197
SBS	611
SBS	713
VESRAH	VD-340
VESRAH	VD-340/2



		CC	KW	FROM	TO	FRONT REAR	LEFT RIGHT	
AKT	M AK 125 EVO	125				F		
	M TTR 125	125				F		
	M AK 150 EVO	150				F		
	M RTX 150	150				F		
	M TTR 150	150				F		
	M XM	180				F		
M XM		200				F		
	M SX 50 Ltd.	50		2014		F		
M RX 125	125		2019		F			
ATK (USA)	M all models 1994-95			1994	1995	F		
	M all models 1994-95			1994	1995	R		
BENELLI	S Caffè Nero 125	125		2011		F		
	S Caffè Nero 125	125		2011		R		
	M Hobby 125 (4T)	125		2013	2013	R		
	M Hobby 125 (4T)	125		2013	2013	F		
	S Macis 125	125		2010		F		
	S Macis 125	125		2010		R		
	S X 125	125		2012	2014	R		
	S X 125	125		2012	2014	F		
	S Caffè Nero 150	150		2011	2012	F		
	S Caffè Nero 150	150		2011	2012	R		
	S Macis 150	150		2010	2012	F		
	S Macis 150	150		2010	2012	R		
	M Caffè Nero 250	250		2008	2011	F	right	
	CAGIVA	M WR 125	125		1993		F	
		M CANYON 500	500		1995		F	
CFMOTO	S CF 125 T-22 Glory	125		2010	2011	F		
	S CF 125 T-21A E-CharM	125		2010	2012	F		
	S CF 150 T-6A Glory	150		2010	2011	F		
	S CF 150 T-5i E-CharM	150		2010	2012	F		
	A CF 500-5 (Rancher 500 UTV)	500		2010	2012	F	left	
	A CF 500 (Terracross)	500		2011	2012	F	right	
	A CF 500 UU-A UForce - side by side	550		2015	2015	F	left	
	A CF 600 ZForce / ZForce EX - side by side	600		2013	2015	F	left	
	A CF 625-3 (Z6 Terracross)	625		2011	2012	F	right	
A CF 800 UU-A UForce - side by side	800		2013	2015	F	left		
A CF 800 EX ZForce - side by side	800		2015		F	left		
DERBI	M RUNNER 50 2T Blacksoul	50		2011		F		
	M SENDA DRD Racing 50	50		2011		F		
	M SENDA Racing 50 SM	50		2018		F		
M FUOCO 500 ie		500		2011		F		
	HONDA	M CA 125 REBEL	125		1995	1997	F	
		M NSR 150	150		2001	2003	R	
M CMX 250 C REBEL		250		1996	2000	F		
HONDA-HM ITALIA		M CRE 50 Baja	50		2011		F	
	M CRM 50 Derapage	50		2011		F		
	M CRE Baja HM 125 4T	125		2011		F		
	M CRM 125 4T Derapage HM	125		2011		F		
HUSQVARNA	M 125 ALL MODELS 1992	125		1992	1992	F		
	M 125 ALL MODELS 1993	125		1993	1993	F		
	M 250 ALL MODELS 1992	250		1992	1992	F		
	M 250 ALL MODELS 1993	250		1993	1993	F		
	M TC 610 CROSS	610		1991		F		
	M TE 610	610		1991		F		
HYOSUNG	M MS3 125	125		2006		F	left	
	M MS3 250	250		2006		F	left	
KAWASAKI	M KLX 125 D (D-Tracker)	125		2010		F		
	M KLX 125 C	125		2010		F		
	M KX 125	125		1989	1994	F		
	M KDX 200 SR	200		1990	1993	F		
	M KDX 250 SR-D	250		1991	1993	F		
	M KLX 250 S	250	16	2009		F		
	M KX 250	250		1989	1993	F		
	M KR 500 ES	500		1993		F		
	M KX 500	500		1989	1994	F		
	M KLR 650	650		2008		F		
	M Ninja H2 SX	998	147	2018		R		
	M Ninja H2 SX SE	998	147	2018		R		
	M Ninja H2 SX SE+	998	147	2019		R		
	KAWASAKI ATV	A KLF 300 BAYOU 4x4 C Series (left)	300		1989	2004	F	
		A KLF 400 BAYOU 4x4 B Series (left)	400		1993	1999	F	
A KVF 650 Brute Force 4X4i All models		650		2007	2008	F	left	
A KRF 750 Teryx 4x4 All mod.-side by side		750		2008		F	left	
A KVF 750 BRUTE FORCE All Models		750		2005	2010	F	left	
KEEWAY	S Partner 110	110		2006	2007	F		
	S Cityblade 125	125		2013		F		
	S 125 Logik	125		2013		F		
	S 125 Logik	125		2013		R		
	S Outlook 125/150	125		2007	2010	F		
S Outlook 125/150	125		2007	2010	R			



		CC	KW	FROM	TO	FRONT REAR	LEFT RIGHT
M Superlight 125		125		2007		F	
	S Cityblade 150	150		2013		F	
S 150 Logik		150		2013		F	
	S 150 Logik	150		2013		R	
M Superlight 150	150		2007	2012	F		
M 250 Blackster	250		2014		F		
M Cruiser 250i	250		2009		F		
S 350i Index	350		2013		F		
KSR MOTO BY GENERIC	S Inox 125 (4T)	125		2012		F	
	S Zion 125/150 (Rear Drum Model)	125		2008	2010	F	
	S Zion 125/150 (Rear Disc Model)	125		2011	2012	F	
KYMCO	S Like 125 EV		3	2020		F	left
	S Agility City + 50 i (4T)	50	2	2019		F	
	M FILLY LX 50	50		2000		F	
	S LIKE LX 50 2T/4T	50		2010		F	
	S NEWSENTO 50i (4T)	50		2017		F	
	S VITALITY 50 (2T & 4T)	50		2004	2009	F	
	M YUP 50	50		2001	2006	F	
	M COBRA 100 RACER	100		1999	2003	F	
	S Capture 125	125		2010		F	
	S LIKE LX 125 4T	125		2010		F	
	S MOVIE 125	125		1998	2000	F	
	S PEOPLE S 125 4T (4V)	125		2017		F	
	M STRYKER 125	125		2001	2006	F	
	M VIVIO 125	125		2000	2003	F	
	M PEOPLE S 150 4T (4V)	150	10	2018		F	
S LIKE LX 200 i	200		2010		F		
M PEOPLE 250 S	250		2006	2008	F	left	
S PEOPLE S 300 i	300		2008	2010	F	left	
PEUGEOT	S e - Satelis			2011		F	
	S e - Satelis			2011		R	
	S e - Vivacity (Electric)			2011	2012	F	
	S DJANGO 50 2T (HERITAGE)	50		2015		F	
	S DJANGO 50 4T (HERITAGE)	50		2015		F	
	S City Star 125 (AC/Carb)	125		2011		F	
	S City Star 125 i (LC)	125		2013		F	
	S City Star 125 Blue Line (AC/Carb)	125		2015		F	
	S DJANGO 125 (HERITAGE)	125		2014		F	
	S Geo RS 125 (Nissin Calipers)	125		2007	2012	F	
	S Geo RS 125 (Nissin Calipers)	125		2007	2012	R	
	S Geopolis 125 Premium (Nissin Caliper/Non ABS)	125		2007	2012	F	
	S Geopolis 125 Premium (Nissin Caliper/Non ABS)	125		2007	2012	R	
	S Satelis 125 Avenue (Nissin Calipers)	125		2008	2009	F	
	S Satelis 125 Avenue (Nissin Calipers)	125		2008	2009	R	
	S SATELIS 125 RS (4T)	125		2013		F	
	S Vivacity 125 (4T)	125		2010	2012	F	
	S Vivacity Sixties 125 (4T)	125		2011	2012	F	
S City Star 151 (AC/Carb)	150		2011		F		
S DJANGO 150 (HERITAGE)	150		2014		F		
S City Star 200 i	200		2012		F		
S Geo 250 (Nissin Caliper)	250		2007	2011	F		
S Geo 250 (Nissin Caliper)	250		2007	2011	R		
S Geopolis 250 Premium (Nissin caliper/ Non ABS)	250		2007	2011	F		
S Geopolis 250 Premium (Nissin caliper/ Non ABS)	250		2007	2011	R		
S Satelis 250 Premium (Nissin Calipers)	250		2007	2012	F		
S Satelis 250 Premium (Nissin Calipers)	250		2007	2012	R		
S Satelis 250 RS (Nissin Calipers)	250		2007	2012	F		
S Satelis 250 RS (Nissin Calipers)	250		2007	2012	R		
S Geopolis 300 RS (Nissin Calipers)	300		2010	2013	F		
S Geopolis 300 RS (Nissin Calipers)	300		2010	2013	R		
S Geopolis 300 (Nissin Calipers/Non ABS)	300		2010	2013	F		
S Geopolis 300 (Nissin Calipers/Non ABS)	300		2010	2013	R		
S Geopolis 300 Style (Nissin Calipers)	300		2010	2013	F		
S Geopolis 300 Style (Nissin Calipers)	300		2010	2013	R		
S Geo RS 400 (Nissin Calipers)	400		2008	2012	F		
S Geo RS 400 (Nissin Calipers)	400		2008	2012	R		
S Geopolis 400 Premium (Nissin Caliper/ Non ABS)	400		2007	2012	F		
S Geopolis 400 Premium (Nissin Caliper/ Non ABS)	400		2007	2012	R		
S Satelis 400 Premium (Nissin Calipers)	400		2008	2013	R		
S Satelis 400 RS (Nissin Calipers)	400		2008	2013	R		
S Satelis 400 Urban (Nissin Calipers)	400		2008	2012	R		
S Geopolis 500	500		2008	2011	R		
S Satelis 500	500		2007	2012	R		
S Satelis 500 RS (Nissin Calipers)	500		2008	2012	R		
PIAGGIO	S VESPA 946 Special - 125 (4T/3V)	125		2013		F	
	S Vespa Sei giorni HPE ABS II ed.	300		2020		F	
QUADZILLA	A RS 6 4WD Left	600		2010	2011	F	
	ROYAL ENFIELD	M Bullet 350	346	14	2009		F
M Thunderbird 350		346	15	2014		F	
M Thunderbird		350		2012		F	

M = MOTORCYCLE
S = SCOOTER
A = ATV
Sn = SNOWMOBILE



		CC	KW	FROM	TO	FRONT / REAR	LEFT / RIGHT
M	BulletElectra X (All disc models/Dual Seat)	500		2005	2014	F	
M	Bullet500 (Efi / Dual Seat)	500		2009	2014	F	
M	BulletClassic 500 (Efi / Single Seat)	500		2009	2014	F	
M	BulletClassic Chrome 500 (Efi / Single Seat)	500		2009	2014	F	
M	BulletBattle Green 500 (Efi / Single Seat)	500		2009	2014	F	
M	BulletDesert Storm 500 (Efi / Single Seat)	500		2012	2014	F	
M	Clubman500 EFi	500		2009	2012	F	
M	Electra500 EFi	500		2009	2014	F	
M	Fury500 (Efi)	500		2011	2012	F	
M	Trials500 EFi	500		2009	2012	F	
M	Woodsmen500 EFi	500		2009	2012	F	
SINNIS	S QM 50 10A (B) Hawk	50		2008	2010	F	
S	QM 50 T-10R Eagle 50	50		2010	2012	F	
M	QM 125- 2 D Stealth 125	125		2008	2010	F	left
M	QM 125 GY Apache 125 (Rear drum model)	125		2009	2010	F	
M	QM 125 GY-2B (A) Apache 125 (Rear disc model)	125		2009	2010	F	
M	QM 125 GY-2B Blade 125	125		2009	2010	F	
SUZUKI	M RM 125 H	125		1987		F	
M	RM 125 J	125		1988		F	
M	RM 125 K - L - M	125		1989	1995	F	
M	TS 125	125		1990	1996	F	
M	TS 200 R	200		1990	1994	F	
M	AN 250 Skywave Type M (BA-CJ45A)	250		2007	2008	F	left
M	AN 250 Skywave Type S (BA-CJ44A)	250		2007	2008	F	left
M	AN 250 8 Skywave SS	250		2008		F	left
M	DJEBEL 250	250		1993		F	
M	DR 250 S	250		1990	2000	F	
M	RM 250	250		1991	1992	F	
M	RM 250 H	250		1987	1988	F	
M	RM 250 K - L - M	250		1989	1994	F	
M	RM 250 R-S	250		1993	1995	F	
M	RMX 250 RP	250		1989	1995	F	
M	DR 350	350		1990		F	
M	DR 350 S-SH-SE	350		1993	1997	F	
M	AN 400 BURGMAN/SKYWAVE ABS	400		2007		F	left
M	AN 400 BURGMAN/SKYWAVE NO ABS	400		2007		F	left
S	BURGMAN 400 ABS	400		2017		F	left
M	RM 500	500		1987		F	
SUZUKI ATV	A LT-F 300 KING QUAD	300		2002		F	left
A	LT-R 450 K/Z	450		2006		F	left
A	LT-A 500 F QUADMASTER	500		2000	2001	F	left
A	LT-F 500 FW/FX/F1 QUADRUNNER (left)	500		1998	2002	F	
SYM	S RS 150	150		2006		R	
TRIUMPH	M BONNEVILLE 800 / T100	100		2001		R	
M	SPEED FOUR 600	600		2002		R	
M	TRIDENT 750	750		1992	1998	F	left
M	AMERICA 865	865		2007		R	
M	AMERICA 865 (12 Spoke Cast wheel)	865		2010		R	
M	AMERICA LT 865	865		2014		R	
M	BONNEVILLE T100 865	865		2005		R	
M	BONNEVILLE California Street Racer 865	865		2008		R	
M	BONNEVILLE T100 BLACK	865		2012		R	
M	BONNEVILLE T100 SE	865		2012		R	
M	BONNEVILLE Newchurch	865		2015		R	
M	BONNEVILLE Spirit	865		2015		R	
M	BONNEVILLE T214	865		2015		R	
M	SCRAMBLER 865	865		2006		R	
M	SPEEDMASTER 865	865		2004		R	
M	SPEEDMASTER	865		2010		R	
M	DAYTONA SPRINT 900	900		1993		F	left
M	SCRAMBLER 900	900		2010		R	
M	STREET CUP	900		2017		R	
M	STREET SCRAMBLER	900		2017		R	
M	STREET TWIN (DP01)	900	40	2016		R	



		CC	KW	FROM	TO	FRONT / REAR	LEFT / RIGHT
M	THRUXTON 900	900		2004	2007	R	
M	THRUXTON 900	900		2008		R	
M	THRUXTON 900 (Front Brembo caliper)	900		2008		R	
M	THRUXTON 900 ACE	900		2015		R	
M	TIGER 900	900		1993	1998	F	left
M	TRIDENT 900 SPRINTER	900		1993	1998	F	left
M	TROPHY 900	900		1993	1995	F	left
M	DAYTONA 955i	955		1997	2000	R	
M	SPEED TRIPLE 955	955		2002		R	
M	SPRINT RS 955 double sided swing arm	955		2003	2004	R	
M	SPRINT RS 955 single sided swing arm	955		2003	2004	R	
M	SPRINT ST 955	955		1999	2004	R	
M	SPEED TRIPLE 1050	1050		2004	2007	R	
M	SPEED TRIPLE 1050	1050		2007	2012	R	
M	SPEED TRIPLE R 1050	1050		2012		R	
M	SPEED TRIPLE R	1050		2016		R	
M	SPEED TRIPLE S	1050		2016		R	
M	Speed Triple RS	1050	110	2019		R	
M	SPRINT GT 1050	1050		2011		R	
M	SPRINT ST 1050 / ABS	1050		2004		R	
M	BONNEVILLE T120 (DU01)	1200	59	2016		R	
M	BONNEVILLE T120 BLACK (DU01)	1200	59	2016		R	
M	Speed twin	1200	71	2020		R	
M	THRUXTON	1200		2016		R	
M	THRUXTON R+	1200		2019		R	
M	ThruXton RS	1200	77	2020		R	
M	ThruXton TFC	1200		2020		R	
M	TROPHY 1200	1200		1993	1995	F	left
M	TIGER EXPLORER 1200	1215		2012		R	
M	TIGER EXPLORER XC 1200	1215		2013		R	
M	TIGER EXPLORER Xc	1215		2016		R	
M	TIGER EXPLORER Xca	1215		2016		R	
M	TIGER EXPLORER Xcx	1215		2016		R	
M	TIGER EXPLORER XR	1215		2016		R	
M	TIGER EXPLORER XRt	1215		2016		R	
M	TIGER EXPLORER XRx	1215		2016		R	
M	TROPHY SE	1215		2012		R	
YAMAHA	M FZR 50	50		1992		F	
M	WR 125	125		1990		F	
M	WR 125	125		1991	1992	F	
M	YBR 125 ED (5HHB/F/H)	125		2006	2008	F	
M	YZ 125	125		1989		F	
M	YZ 125 all models	125		1990	1997	F	
M	DT 200 WR	200		1991		F	
M	WR 200 B	200		1991	1994	F	
M	TT 250 R	250		1993	1999	F	
M	TT-R 250	250		2000		F	
M	WR 250 (Z 2T)	250		1991	1997	F	
M	YZ 250	250		1989		F	
M	YZ 250 A - B	250		1990	1992	F	
M	YZ 250	250		1990	1997	F	
M	YZ 250	250		1995	1997	F	
M	YZ 360	360		1989		F	
M	WR 500 B	500		1991	1992	F	
M	WR 500 ZD - ZE	500		1992	1993	F	
M	XTZ 750 SUPER TENERE	750		1989		F	left
YAMAHA ATV	A YFZ 450	450		2004	2005	F	left
A	YFZ 450 - All models	450		2006		F	left
A	YXR 450 RHINO - side by side	450		2004	2009	F	left
A	YXR 660 RHINO - side by side	660		2004	2007	F	left
A	YFM 700 RAPTOR - All Models	700		2006		F	left
A	YXR 700 RHINO - side by side	700		2008		F	right
A	YXR 700 RHINO - side by side	700		2008		R	right

FDB498

67.6 x 50.9 x 7.1 mm

MATERIAL AVAILABILITY											
AG	EF	P	PRP	ST	SM	SG	ZR	XRAC	ZRAC	CP1	CPRO
		✓		✓				✓			

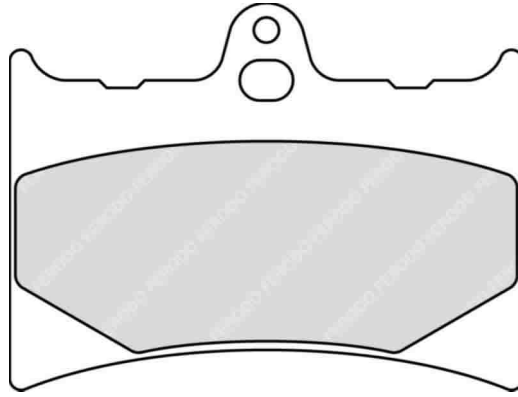

CROSS REFERENCE	
BRAKING	726
BREMBO	07GR56
BRENTA	3031
BRENTA	4031
CL BRAKES	2398
EBC	FA126
GALFER	FD085
GALFER	FD118
GOLD FREN	019
LUCAS/TRW	MCB572
NEWFREN	FD0115
SBS	601
VESRAH	VD-943

		CC	KW	FROM	TO	FRONT / REAR	LEFT / RIGHT
	ALFER						
	M MC 125	125		1988		F	
	M GR 250 ENDURO	250		1988		F	
	M MC 250	250		1988		F	
	M GR 300 ENDURO	300		1989		R	
APRILIA	M AF1 125 REPLICA	125		1989	1991	F	
	M AF1 125 SINTESI	125		1989	1991	F	
	M AF1 125 FUTURA	125		1990	1991	F	
	M AF1 125 EUROPA	125		1990	1991	F	
	M AF1 FUTURA SPORT PRO 125	125		1993	2003	F	
	M RS 125 EXTREMA - REPLICA	125		1993	1997	F	
	M RS 125	125		2000	2003	F	
	M RS 125	125		2004	2006	F	
	M TUONO 125 2T	125		2003	2004	F	
	M AF1 250 REPLICA	250		1990		F	
ATK (USA)	M all models 1988			1988		F	
	M all models 1989-93			1989	1993	F	
BENELLI	M DEVIL 50	50		1992		F	
	M SPRING 50	50		1992		F	
	M DEVIL 80	80		1995		F	
	M 125 JARNO	125		1989		F	
GILERA	M CRONO 125	125		1991		F	
	M CX 125	125		1991		F	
	M GFR 125	125		1993		F	
	M MX 1 125	125		1988		F	
	M MX R 125	125		1990		F	
	M SP 01 125	125		1989		F	

		CC	KW	FROM	TO	FRONT / REAR	LEFT / RIGHT
	KTM						
	M SP 02 125	125		1990		F	
	M CHRONO 50 SCOOTER	50		1994		F	
	M GS 125 XC ENDURO SPORT	125		1986	1987	F	
	M GS 125 XC ENDURO SPORT	125		1986	1987	R	
	M MX 125 VC CROSS	125		1986	1987	F	
	M MX 125 VC CROSS	125		1986	1987	R	
	M GS 250 XC ENDURO SPORT	250		1986	1987	F	
	M GS 250 XC ENDURO SPORT	250		1986	1987	R	
	M MX 250 VC CROSS	250		1986	1987	F	
	M MX 250 VC CROSS	250		1986	1987	R	
	M GS 300 XC ENDURO SPORT	300		1986	1987	F	
	M GS 300 XC ENDURO SPORT	300		1986	1987	R	
	M MX 500 CROSS	500		1986	1987	F	
	M MX 500 CROSS	500		1986	1987	R	
	M GXE 550	550		1986	1987	F	
	M GXE 550	550		1986	1987	R	
	M MX 550 LC4	550		1987		F	
	M MX 550 LC4	550		1987		R	
	M ENDURO 600 all models	600		1986	1987	F	
M ENDURO 600 all models	600		1986	1987	R		
MOTO GUZZI	M QUOTA 1000	1000		1993	1995	F	
MZ	M SKORPION CUP / SPORT / TOUR / TRAVELLER	660		1995		F	
SACHS	M XTC 125 SUPERSPORT	125		2000		F	
	M ROADSTER 650	650		2001		F	
	M ROADSTER 800	800		2001		F	

M = MOTORCYCLE
S = SCOOTER
A = ATV
Sn = SNOWMOBILE

FDB499

100.0 x 47.0 x 8.5 mm

MATERIAL AVAILABILITY

AG	EF	P	PRP	ST	SM	SG	ZR	XRAC	ZRAC	CP1	CPRO
		✓									

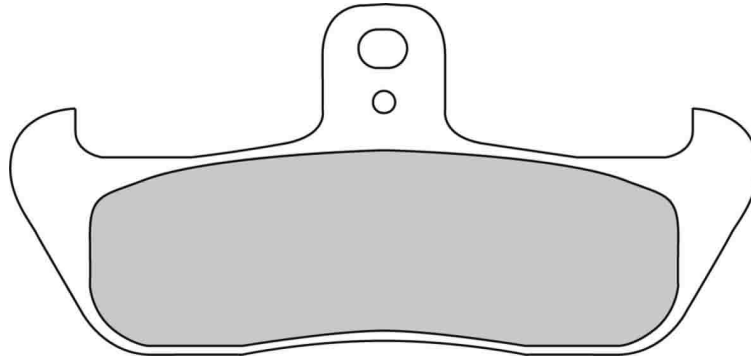

CROSS REFERENCE

BREMBO	07BB09
CL BRAKES	2400
EBC	FA134
GALFER	FD089
LUCAS/TRW	MCB579
NEWFREN	FD0113
SBS	608
VESRAH	VD-942



		CC	KW	FROM	TO	FRONT / REAR	LEFT / RIGHT
ALFER	M AR 250	250		1992	1992	F	
	M GR 300 ENDURO	300		1989		F	
APRILIA	M AF1 125	125		1987		F	
	M TUAREG 350 WIND	350		1989		F	
CAGIVA	M WMX 50	50		1989		F	
	M N 90 ENDURO	90		1990		F	
	M CRUISER 125	125		1987		F	
	M FRECCIA 125	125		1987		F	
	M FRECCIA 125 C9	125		1988		F	
	M WMX 125 CROSS	125		1987		F	
	M WMX 250 CROSS	250		1987		F	
	M ELEFANT 750 BIFARO	750		1990		F	
GILERA	M APACHE 125	125		1991		F	
	M RC 125 TOP RALLY	125		1989		F	
	M RC 600	600		1989	1990	F	
	M RC 600 TOP RALLY	600		1990		F	
HONDA-HM ITALIA	M CRE 50 (up to frame nr.1000)	50				F	
HUSABERG	M MC 350	350		1991	1993	F	
	M MC 350	350		1994		F	
	M 500 all models	500		1991	1992	F	
	M 501 ENDURO	500		1992	1993	F	
	M 600 ENDURO	600		1992	1993	F	
HUSQVARNA	M CR 125 CROSS	125		1991	1995	F	
	M WR 125	125		1987	1990	F	
	M WR 125	125		1991	1997	F	
	M WRE 125	125		1988		F	
	M WRE 125	125		1989	1994	F	
	M CR 240	240		1987		F	
	M WR 240	240		1987	1990	F	
	M WR 240	240		1991		F	
	M WRK 240	240		1988		F	
	M CR 250 CROSS	250		1991	1995	F	
	M WR 250	250		1987	1989	F	
	M WR 250	250		1990	1991	F	
	M WR 250	250		1992	1994	F	



		CC	KW	FROM	TO	FRONT / REAR	LEFT / RIGHT	
	M XC 250	250		1987		F		
	M WR 260	260		1991		F		
	M WRK 260	260		1988		F		
	M TE 350	350		1990	1995	F		
	M WR 400	400		1987		F		
	M AE 430	430		1988		F		
	M AUTO 430	430		1987		F		
	M CR 430	430		1987		F		
	M WR AE 430	430		1987		F		
	M XC 430	430		1987		F		
	M XC 500	500		1987		F		
	M TC 510	510		1988		F		
	M TE - AC - LC 510	510		1987		F		
	M TE 510	510		1988	1990	F		
	M WRK 600	600		1989		F		
	KRAM IT	M ER 125 RV 3	125		1988		F	
		M ER 250 RV 3	250				F	
	M ER 300 RV 3	300		1988		F		
LAVERDA	M CR 600 CRUISER	600		1987		F		
MOTO MORINI	M EXCALIBUR 501	50		1989		F		
	M NEW YORK 501	50		1989		F		
	M COGAURO 350	350		1990		F		
	M DART 350	350		1988	1989	F		
	M EXCALIBUR RLX 350	350		1990		F		
	M NEW YORK 350	350		1989		F		
	TM	M all models 80	80		1990	1993	F	
	M GS 80	80		1986	1989	F		
	M MC 80	80		1986	1989	F		
	M GS 125	125		1986	1989	F		
	M GS / MC 125	125		1990	1993	F		
	M MC 125	125		1986	1989	F		
	YAMAHA	M DT 80 LC (Espana)	80		1989		F	
		M DT 125 CHESTERFIELD SCOUT	125		1989		F	
M TDR 125 (Italia)		125		1990	1991	F		
	M TDR 125	125		1992		F		

FDB508

106.0 x 39.0 x 8.3 mm / 76.0 x 27.0 x 9.7 mm

MATERIAL AVAILABILITY											
AG	EF	P	PRP	ST	SM	SG	ZR	XRAC	ZRAC	CP1	CPRO
		✓									

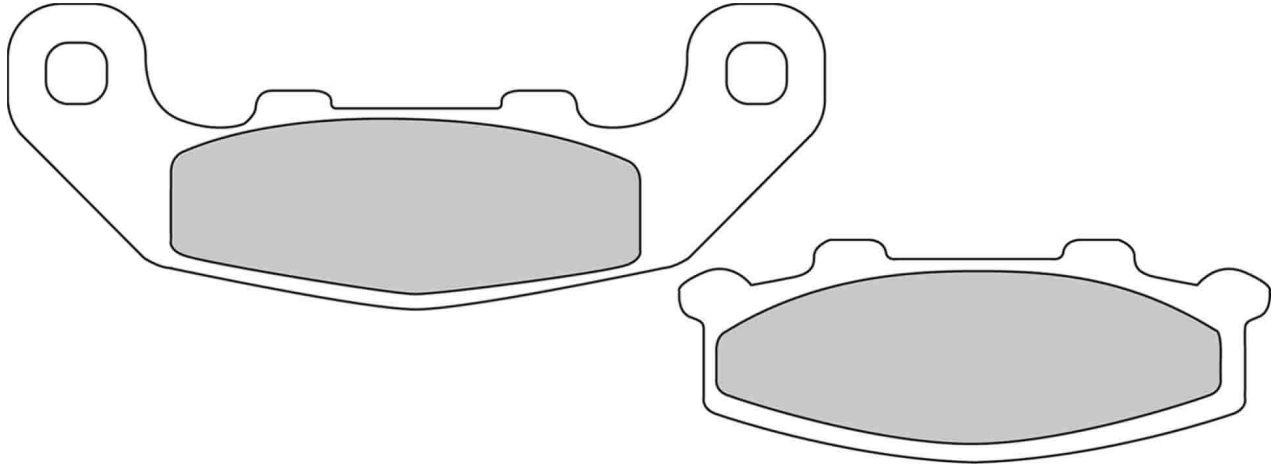

CROSS REFERENCE	
BRAKING	712
BREMBO	07KA11
CL BRAKES	2389
EBC	FA141
GALFER	FD104
LUCAS/TRW	MCB586
NEWFREN	FD0138
SBS	615
VESRAH	VD-430

		CC	KW	FROM	TO	FRONT / REAR	LEFT / RIGHT
	KAWASAKI						
	M	GPX 250 R NINJA	250		1987 1995	R	
	M	KR-1 250	250		1988	R	
	M	KR-1 250	250		1989	F	
	M	KR-1 250	250		1989	R	
	M	KR-1 250 C1 - C3	250		1990 1992	R	
	M	ZXR 250	250		1989	F	
	M	GPX 400 R	400		1987	F	
	M	GPX 400 R	400		1988	F	
	M	GPX 400 R	400		1988	R	
	M	GPZ 400 R	400		1990	F	
	M	XANTUS 400	400		1992	F	
M	ZR 400 ZEPHYR (ZR-C)	400		1989 1992	R		

		CC	KW	FROM	TO	FRONT / REAR	LEFT / RIGHT	
								
	M	ZX 4 400	400		1988	F		
	M	ZX 4 400	400		1988	R		
	M	ZEPHYR 550	550		1991	R		
	S	ZR 550 ZEPHYR	550		1990 1992	R		
	M	ZR 750 ZEPHYR	750		1991 1993	R		
	M	KR 1250	1250		1989	F		
	M	KR 1250	1250		1989	R		
	SUZUKI	M	RGV 250 R	250		1990 1992	R	
	M	RGV 250	250		1994 1996	R		
M	RGV 500 GAMMA	500		1990	R			
M	GSX 1100 G	1100		1993 1996	R			

M = MOTORCYCLE
S = SCOOTER
A = ATV
Sn = SNOWMOBILE

FDB529

100.0 x 52.0 x 7.8 mm

MATERIAL AVAILABILITY



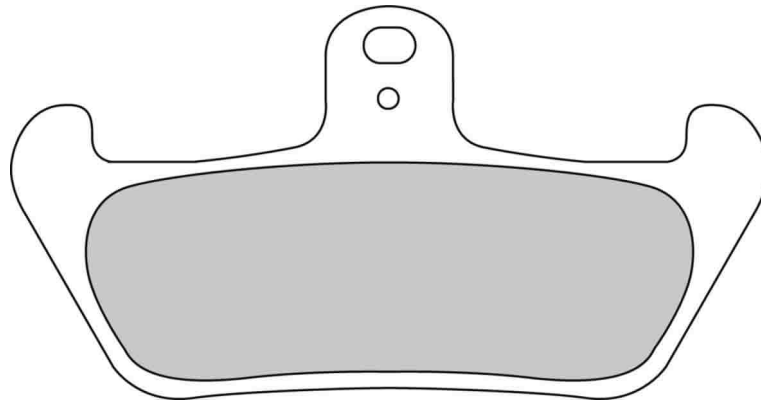

AG	EF	P	PRP	ST	SM	SG	ZR	XRAC	ZRAC	CP1	CPRO
		✓									



CROSS REFERENCE

BREMBO	07BB16
EBC	FA163
GALFER	FD119
LUCAS/TRW	MCB618
NEWFREN	FD0158
SBS	641
VESRAH	VD-927
VESRAH	VD-929

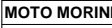
		CC	KW	FROM	TO	FRONT REAR	LEFT RIGHT
	M TUAREG 125 WIND	125		1990		F	
	M TUAREG 350 WIND	350		1990		F	
	M TUAREG 600 WIND	600	34	1988	1990	F	
	M TUAREG 600 WIND PARIS-DAKAR	600	34	1989	1989	F	
	M SUPERCITY 50	50		1993		F	
	M SUPERCITY 80	80		1994		F	
	M FRECCIA 125 C10 R	125		1988		F	
	M FRECCIA 125 C10	125		1988		F	
	M FRECCIA 125 C10 ANNIVERSARIO	125		1989		F	
	M FRECCIA 125 C12 R	125		1989	1990	F	
	M FRECCIA 125 C12 R	125		1991		F	
	M K7 125 ENDURO	125		1991		F	
	M MITO 125	125		1991	1992	F	
	M N 125	125		1991		F	

		CC	KW	FROM	TO	FRONT REAR	LEFT RIGHT	
	M SUPERCITY 125	125		1994		F		
	M TAMANACO 125	125		1989		F		
	M W8 125 PRO ACTION	125		1992	1995	F		
	M W8 125 PRO ACTION	125		1996		F		
	M W 12 350	350		1992		F		
	M W 16 650	650		1993		F		
	M ELEFANT 750	750		1988	1989	R		
		M RC 600	600		1991		F	
		M RC 600 NORD WEST	600		1991		F	
		M RC 600 R	600		1991		F	
	M COGUARO 501	50		1989		F		
	M DART 350	350		1990		F		
	M DART 400	400		1990		F		
	M WOLF 250	250		1990		F		

FDB531

86.2 x 40.5 x 10.6 mm

MATERIAL AVAILABILITY											
AG	EF	P	PRP	ST	SM	SG	ZR	XRAC	ZRAC	CP1	CPR0
	✓	✓		✓							

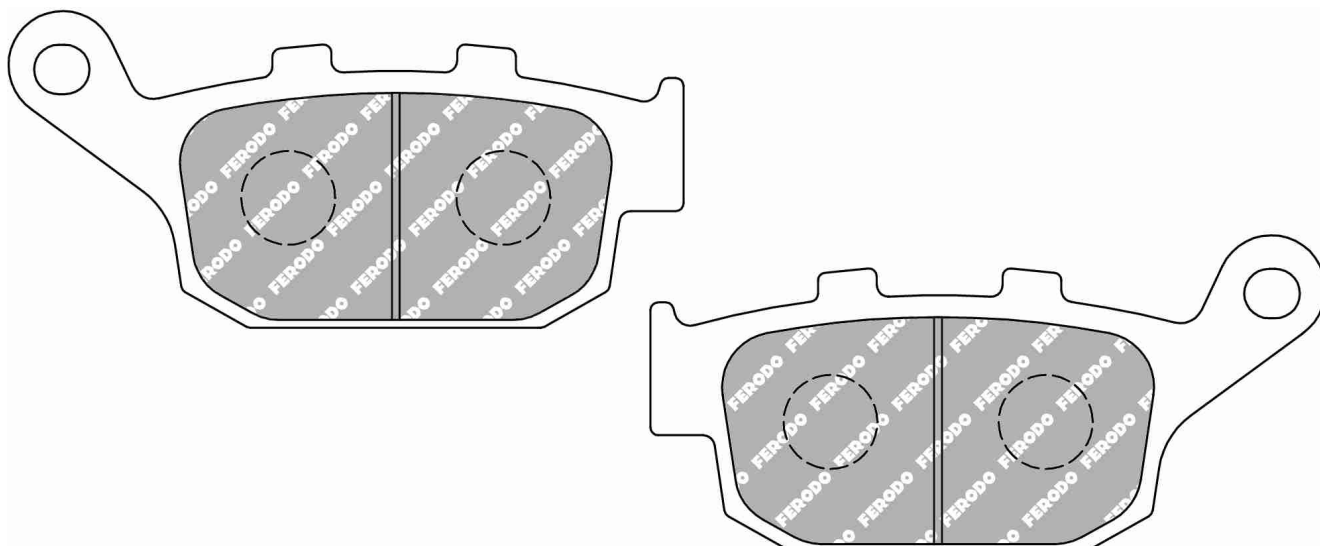

ALSO AVAILABLE		
SHAPE	TH. MM	NOTES
FDB2258	8.9	

CROSS REFERENCE	
BRAKING	711
BREMBO	07HO27
BREMBO	7029
BRENTA	3073
BRENTA	4073
CL BRAKES	2298
EBC	FA140
GALFER	FD103
GOLD FREN	020
LUCAS/TRW	MCB585
NEWFREN	FD0136
SBS	161
SBS	614
VESRAH	VD-147

		CC	KW	FROM	TO	FRONT / REAR	LEFT / RIGHT
	BUELL						
	M S1 Lightning-Whitelighting			1998	2002	R	
	M S3-S3T Thunderbolt			1998	2002	R	
	M X1			1998	2002	R	
	M X1 Lightning			2000	2005	R	
	M Blast 500	500		2000	2007	R	
	M Firebolt XB9R	984		2002	2007	R	
	M XB9S Lightning	984		2003	2004	R	
	M XB9SX Lightning CityX	984		2005	2009	R	
	M XB9 SX Lightning	984		2008	2010	R	
	M M2 Cyclone	1200		1998	2002	R	
	M M2 Cyclone	1200		2000	2005	R	
	M XB12 R Firebolt	1200		2004	2008	R	
	M XB12 R Firebolt	1200		2009	2010	R	
	M XB12 STT Lightning	1200			2008	R	
	M XB12 S Lightning	1200		2004	2008	R	
M XB12 SCG Lightning	1200		2006	2008	R		
M XB12 Ss Lightning Long	1200		2006	2008	R		
M XB12 S Lightning	1200		2009	2010	R		

		CC	KW	FROM	TO	FRONT / REAR	LEFT / RIGHT
	HONDA						
	M XB12 SCG Lightning	1200		2009	2010	R	
	M XB12 Ss Lightning Long	1200		2009	2010	R	
	M XB12 X Ulysses	1200		2006	2010	R	
	M XB12 XT Ulysses	1200		2008	2010	R	
	S FES 150 PANTHEON	150		2003	2006	R	
	M CB 250 JADE	250		1991		R	
	M CB 250 F/HORNET	250		1996	2001	R	
	M CBR 250 R HURRICANE	250		1986	1988	R	
	M CBR 250 R - RR	250		1990	1994	R	
	S FES 250 FORESIGHT	250		1999		R	
	M NSR 250 R	250		1988	1993	R	
	M NSR 250 R SP	250		1988	1993	R	
	M RS 250 R	250		1991		R	
	M VT 250 SPADA	250		1988		R	
	M VTR 250 (MC33)	250		1998	2009	R	
M CB 400 SUPER FOUR	400		1992		R		
M CB 400 SUPER FOUR S	400		1997	1998	R		
M CB-1 400 F	400		1989		R		

M = MOTORCYCLE
S = SCOOTER
A = ATV
Sn = SNOWMOBILE

		CC	KW	FROM	TO	FRONT / REAR	LEFT / RIGHT
M	CB 400 FK (CB-1)	400		1990		R	
M	CBR 400 RRJ/RRK (NC23) Tri-Arm (102/109)	400		1987	1989	R	
M	CBR 400 RRL/RRN/RRR (NC29) Gull Arm	400		1990	1994	R	
M	NTV 400 BROS	400		1988		R	
M	TRANSALP 400	400		1992		R	
M	VFR 400 R	400		1987	1989	R	
M	CMX 500 Rebel S	471	34	2020		R	
M	CB 500 F	500	35	2019		R	
M	CB 500 F (PC45)	500	35	2013		R	
M	CB 500 X (PC46)	500	35	2013		R	
M	CBR 500 R	500	35	2013	2015	R	
M	CBR 500 R	500	35	2016		R	
M	CMX 500 Rebel	500	34	2019		R	
M	NX 500 DOMINATOR	500		1988	1996	R	
M	NTV 600 BROSS	600		1988	1992	R	
M	NTV 600 REVERE - HAWK	600		1990	1992	R	
M	XL 600 V TRANSALP	600		1991	1993	R	
M	XL 600 V TRANSALP	600		1994	1996	R	
M	XL 600 V TRANSALP	600		1997	1999	R	
M	FMX 650	650		2007		R	
M	NT 650 HAWK GT	650		1988	1990	R	
M	NT 650 V DEAUVILLE	650		1998	2001	R	
M	NTV 650 REVERE	650		1988	1993	R	
M	NTV 650 BROS - I	650		1990	1993	R	
M	NTV 650	650		1994	1997	R	
M	NX 650 DOMINATOR	650		1988	1992	R	
M	NX 650 DOMINATOR	650		1993	1994	R	
M	NX 650 DOMINATOR	650		1995	1997	R	
M	XL 650 V TRANSALP	650		2000		R	
M	XRV 650 AFRICA TWIN (RD03)	650	37	1988	1990	R	
M	XL 700 V TRANSALP (No ABS Front)	680	44	2007		R	
M	NC 700 S,X (man.gearbox - No ABS)	700		2012		R	
M	XRV 750 AFRICA TWIN (RD04)	750	37	1990	1993	R	

		CC	KW	FROM	TO	FRONT / REAR	LEFT / RIGHT
M	XRV 750 AFRICA TWIN (RD04)	750	43	1990	1993	R	
M	XRV 750 AFRICA TWIN (RD07)	750	37	1994	2003	R	
M	XRV 750 AFRICA TWIN (RD07)	750	44	1994	2003	R	
PEUGEOT	M SV 250	250		2001		R	
SINNIS	M QM 125- 2 D Stealth 125	125		2008	2010	R	
TRIUMPH	M TT 600	600		2000	2003	R	
M	DAYTONA 675	675		2009	2012	R	
M	DAYTONA 675 R	675		2011	2012	R	
M	DAYTONA 675 / Special Edition / Triple	675		2006	2008	R	
M	STREET TRIPLE 675	675		2007	2012	R	
M	STREET TRIPLE 675 R	675		2009	2012	R	
M	BONNEVILLE 800 (USA version)	800		2001		R	
M	TIGER 800	800	70	2011	2014	R	
M	TIGER 800 XC (A08)	800	70	2011	2014	R	
M	TIGER 800 XC (A082)	800	70	2015	2017	R	
M	TIGER 800 XCx (A082)	800	70	2015	2017	R	
M	TIGER 800 XR (A082)	800	70	2015	2017	R	
M	TIGER 800 XRx (A082)	800		2015	2017	R	
M	TIGER 800 Xca	800		2015	2017	R	
M	TIGER 800 XRT	800		2017	2017	R	
M	TIGER 800 XRx Low	800		2018		R	
M	TIGER 800 Xca	800		2018		R	
M	TIGER 800 XCx (A082)	800	70	2018		R	
M	TIGER 800 XRT	800		2018		R	
M	DAYTONA 955i	955		2001	2004	R	
M	TIGER XC	1050		2011		R	
M	BONNEVILLE BOBBER	1200	57	2017		R	
M	BONNEVILLE BOBBER BLACK	1200	57	2017		R	
YAMAHA	S X-Max 250 Momodesign (SG22)	250	15	2015		R	
M	FZ6R 600	600		2009		R	
M	XJ6-F Diversion 600 (Non ABS&ABS models)	600		2010	2013	R	
M	XJ6-N Diversion 600 (Non ABS&ABS models)	600		2009	2013	R	
M	XJ6-S Diversion 600 (Non ABS&ABS models)	600		2009	2013	R	

FDB533

68.1 x 53.8 x 8.7 mm

MATERIAL AVAILABILITY											
AG	EF	P	PRP	ST	SM	SG	ZR	XRAC	ZRAC	CP1	CPRO
		✓		✓				✓		✓	

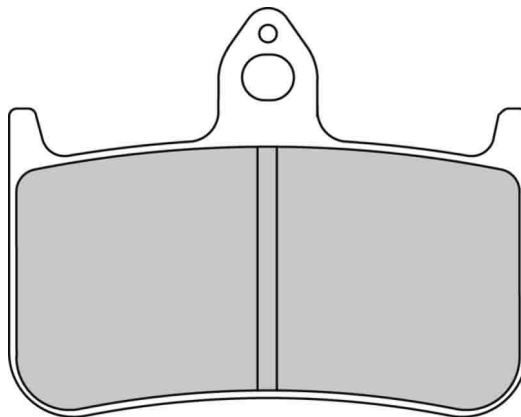

Pinze / Calipers

Honda

Honda 4 Piston, Nissin

CROSS REFERENCE

BREMBO	07HO28
CL BRAKES	2245
EBC	FA187
GALFER	FD100
GALFER	FD148
LUCAS/TRW	MCB593
NEWFREN	FD0131
SBS	622
VESRAH	VD-154

4084

FERODO

RACING

Updated on November 2020

M = MOTORCYCLE
S = SCOOTER
A = ATV
Sn = SNOWMOBILE

		CC	KW	FROM	TO	FRONT / REAR	LEFT / RIGHT
HONDA	M CB 250 F/HORNET	250		1996	2001	F	
	M CBR 250 R - RR	250		1990	1994	F	
	M NSR 250 R	250		1988	1993	F	
	M NSR 250 R SP	250		1988	1993	F	
	M RS 250 R	250		1991		F	
	M NTV 400 BROS	400		1988		F	
	M VTR 400 R (NC 30)	400		1989	1991	F	
	M NTV 600 BROSS	600		1988	1992	F	
	M NTV 650 BROS - I	650		1990	1993	F	

		CC	KW	FROM	TO	FRONT / REAR	LEFT / RIGHT
M	NR 750	750		1992		F	
M	VFR 750 R (RC-30)	750		1988	1993	F	
M	CB 900 HORNET	900		2002		F	
M	CBR 900 RR-FIREBLADE (SC28)	900		1992	1995	F	
M	CB 1000 SF	1000		1993	1997	F	
M	CBR 1000 BIG ONE	1000		1993	1997	F	
M	VTR 1000 FV FIRESTORM - SUPERHAWK	1000		1997	2000	F	
M	CB 1300 X4	1300		1997	2000	F	

FDB538

90.0 x 49.0 x 9.0 mm

MATERIAL AVAILABILITY											
AG	EF	P	PRP	ST	SM	SG	ZR	XRAC	ZRAC	CP1	CPO
		✓									

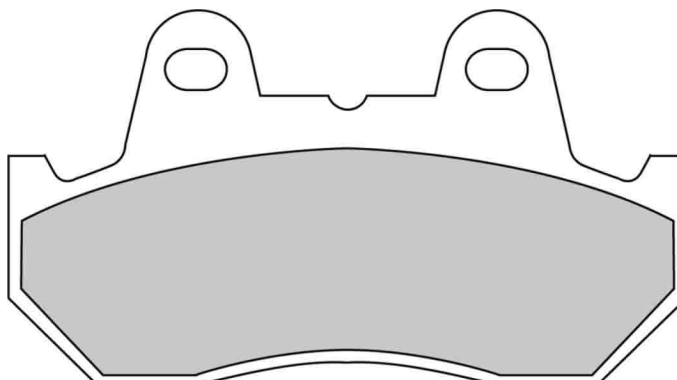

ALSO AVAILABLE		
SHAPE	TH. MM	NOTES
FDB244	10.5	
FDB665	11.0	

CROSS REFERENCE	
BREMBO	07HO18
BREMBO	7025
CL BRAKES	2382
CL BRAKES	3017
COBREQ	N-912
EBC	FA069/2
FRAS-LE	PD/854
GALFER	FD054
LUCAS/TRW	MCB544
NEWFREN	FD0058
SBS	572
VESRAH	VD-123/2

		CC	KW	FROM	TO	FRONT / REAR	LEFT / RIGHT
HONDA	S CN 250 HELIX-FUSION	250		1990	1992	F	
	S CN 250 HELIX-FUSION	250		1993	2000	F	
	M VT 250 F-II	250		1982	1982	F	
	M CB 400 N/F	400		1983		F	
	M CBX 400 C	400		1983		F	
	M NS 400 RF - RG	400		1985		F	
	M VF 400 F INTEGRA	400		1982		F	
	M VF 700 F INTERCEPTOR	700		1984	1985	R	
	M VFR 700 F/F2 INTERCEPTOR	700		1986	1987	R	
	M CBR 750 F HURRICANE	750		1987	1988	R	

		CC	KW	FROM	TO	FRONT / REAR	LEFT / RIGHT
M	VF 750 CH	750		1987	1989	F	
M	VFR 750 C V45 MAGNA	750		1988		F	
M	CBR 1000 F	1000		1987	1988	R	
M	CBR 1000 R HURRICANE	1000		1987	1988	R	
M	CB 1100 RC ventilated discs	1100		1980	1983	F	
M	CB 1100 RC ventilated discs	1100		1980	1983	R	
M	CB 1100 RC	1100		1980	1983	F	
M	CB 1100 RC	1100		1980	1983	R	
M	CBX 1100 F	1100		1982	1985	F	

M = MOTORCYCLE
S = SCOOTER
A = ATV
Sn = SNOWMOBILE

FDB539

75.1 x 36.1 x 9.7 mm

MATERIAL AVAILABILITY											
AG	EF	P	PRP	ST	SM	SG	ZR	XRAC	ZRAC	CP1	CPRO
	✓	✓				✓					

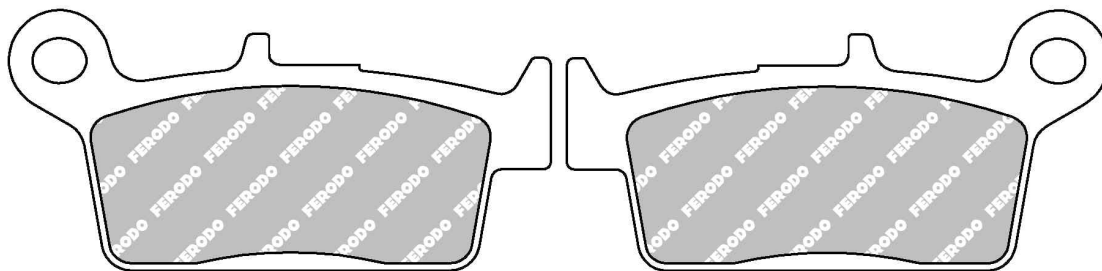

ALSO AVAILABLE		
SHAPE	TH. MM	NOTES
FDB672	9.1	
FDB783	7.6	

CROSS REFERENCE	
BRAKING	701
BREMBO	07HO26
BRENTA	3087
BRENTA	4087
CL BRAKES	2314
EBC	FA131
GALFER	FD093
GOLD FREN	003
LUCAS/TRW	MCB575
NEWFREN	FD0114
SBS	604
VESRAH	VD-144

		CC	KW	FROM	TO	FRONT / REAR	LEFT / RIGHT
AJP	M PR5 250 Enduro	250		2009	2009	R	
	M PR5 250 Supermoto	250		2009	2009	R	
DERBI	M GPR 50 NAKED	50		2004	2006	R	
	M GPR 80 CUP	80		2004	2007	R	
GASGAS	M EC / MC 125	125		2000		R	
	M EC 200	200		2001		R	
	M EC / MC 250	250		2000		R	
	M EC / MC 300	300		2000		R	
	M EC 400	400		2001		R	
	M FSE 450 SM	450		2003		R	
	M FSE 450	450		2004		R	
	M CRM 50	50		1993	1996	R	
HONDA	M NSR 50 (Spain)	50				R	
	M CRM 75	75		1990	1994	R	
	M CRM 75 R	75		1990	1994	R	
	M YUPY 75	75		1991		F	
	M CR 80 R	80		1992	1995	R	
	M CR 80 R/RB	80		1996	2002	R	
	M CRM 80	80		1993		R	
	M NSR 80 R	80		1987	1992	R	
	M NSR 80 R	80		1993	1998	R	
	M CR 85 R/RB	85		2003	2007	R	
	M CR 125 RH - J - K - L	125		1987	1994	R	
	M CR 125 RW - RX - RY - R1	125		1996	2001	R	
	M CRM 125	125		1990	1999	R	
	M XLR 125	125		1993		R	
	M XLR 200 R	200		1993		R	
	M CRF 230 F	230		2008		R	
	M EASY 230 Enduro /SM	230		2008		R	
	M CR 250 R	250		1987	1994	R	
	M CR 250 R	250		1996	2001	R	
	M CRM 250 R	250		1989	1990	R	
M CRM 250 R	250		1991		R		

		CC	KW	FROM	TO	FRONT / REAR	LEFT / RIGHT	
	M XL 250	250		1990	1990	R		
	M XLR 250 R BAJA	250		1988	1990	R		
	M XLR 250 R	250		1991		R		
	M XLR 250 R BAJA	250		1991		R		
	M XR 250 R	250		1988	1993	R		
	M XR 250 L	250		1991	1995	R		
	M XR 250 R	250		1994		R		
	M XR 400 R (All Models)	400		1996		R		
	M XR 400 SUPERMOTARD	400		2000		R		
	M XR 440 R (DALL'ARA)	440		1999		R		
	M CR 500 R	500		1987	1992	R		
	M CR 500 R	500		1993	1994	R		
	M CR 500 R	500		1995	2001	R		
	M XR 600 R	600		1991	1993	R		
	M XR 600 L - R	600		1994	2002	R		
	M XR 650 L	650		1993	1995	R		
	M XR 650 L	650		1996		R		
	M XR 650 R	650		1999		R		
	HONDA-HM ITALIA	M CRE 260	260		1990		R	
	HUSQVARNA	M TE 125	125		2007	2010	R	
		M WXE 125	125		2007		R	
	KAWASAKI	M KX 125	125		1996	2002	R	
		M KX 125	125		2003		R	
		M KDX 250 K2-K4	250		1995		R	
M KLX 250 D-Tracker		250		1998	2003	R		
M KLX 250 S		250		2006	2007	R		
M KLX 250 S		250	16	2009		R		
M KX 250		250		1996	2002	R		
M KX 250		250		2003		R		
M KLX 300 R		300		1997	2003	R		
M KX 500 E8/E9		500		1996		R		
KYMCO	M SUPER 9 50	50		1999	2000	F		
PEUGEOT	M SV 80 EXECUTIVE	80		1996		F		

		CC	KW	FROM	TO	FRONT / REAR	LEFT / RIGHT	
SUZUKI	M RM 125 T- U - V	125		1996	1998	R		
	M RM 125 X - Y - K1	125		1999	2008	R		
	M RM 250 T/V	250		1996	1999	R		
	M RM 250	250		2000	2008	R		
	M DR-Z 400 S	400		2000		R		
	M DR-Z 400 E	400		2000		R		
	M DR-Z 400 SM	400		2005		R		
	SYM	M SR 100 SUNRISE	100		1998		F	
	TM	M MX 85 (Big Wheel)	85		2002	2004	R	
		M MX 85 JR (Small Wheel)	85		2002	2004	R	
		M Enduro EN 125 (2T)	125		2001	2004	R	
		M Enduro EN 125 (2T)	125		2005		R	
		M MX 125 (2T)	125			2004	R	
		M Enduro EN 250 (2T)	250		2001	2004	R	
M MX 250 (2T)		250		2001	2004	R		
M MX 250 (4T) Cross		250		2002	2004	R		
M SM 250		250		2002		R		
M SME 250 (4T)		250		2004		R		
M Enduro EN 300 (2T)		300		2001	2004	R		
M MX 300 (2T)		300		2001	2004	R		
M 400 (4T) MX Cross		400		2002	2003	R		
M SM 400		400		2002	2003	R		

		CC	KW	FROM	TO	FRONT / REAR	LEFT / RIGHT	
	M SME 400 (4T)	400		2004		R		
	M EN 450 F (4T)	450			2004	R		
	M MX 450 F (4T)	450			2004	R		
	M MX 450 F - USA version	450		2005	2008	R		
	M SMX 450 F Competition (4T)	450		2005	2008	R		
	M 530 (4T) Cross	530		2002	2003	R		
	M EN 530 F (4T)	530			2004	R		
	M MX 530 F	530			2004	R		
	M SM 530	530		2002	2003	R		
	M SME 530 (4T)	530		2004		R		
	M SMX 660 F	660			2004	R		
	YAMAHA	M YZ 125 all models	125		1998	2002	R	
	M TT-R 250	250		2000		R		
	M WR 250 (ZK 2T - FN&FT 4T)	250		1998	2002	R		
M YZ 250 K/L/M	250		1998	2000	R			
M YZ 250 N-P (2T)	250		2001	2002	R			
M YZ 250 FN-FP (4T)	250		2001	2002	R			
M WR 400 F	400		1999	2001	R			
M YZ 400 F	400			1998	R			
M WR 426 FN	426		2001	2002	R			
M YZ 426 FM / FN	426		2000	2002	R			

FDB557

70.0 x 56.0 x 8.8 mm

MATERIAL AVAILABILITY											
AG	EF	P	PRP	ST	SM	SG	ZR	XRAC	ZRAC	CP1	CPR0
	✓	✓		✓				✓		✓	

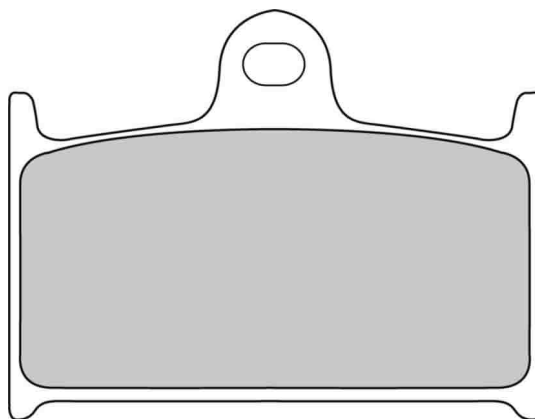

CROSS REFERENCE	
BRAKING	707
BREMBO	07SU14
BREMBO	07SU22
BRENTA	3127
BRENTA	4127
CL BRAKES	2246
CL BRAKES	2961
EBC	FA145
EBC	FA236
GALFER	FD099
GOLD FREN	017
LUCAS/TRW	MCB595
NEWFREN	FD0129
SBS	624
SBS	714
VESRAH	VD-343
VESRAH	VD-343/2

M = MOTORCYCLE
S = SCOOTER
A = ATV
Sn = SNOWMOBILE

		CC	KW	FROM	TO	FRONT	LEFT	
						REAR	RIGHT	
SUZUKI	M RGV 250 R	250		1988		F		
	M GSX-R 400 R	400		1990	1995	F		
	M GSX-R 750	750		1988	1993	F		
	M RF 900 RR	900		1994	1995	F		
	M RF 900 RT - RV	900		1996	1999	F		
	M GSX-R 1100 K - L - M - N	1100		1989	1992	F		
	M GSF 1200 T-ST-V-SV- BANDIT	1200		1995	2000	F		
	TRIUMPH	M BABY SPEED 600	600		2004		F	
	M DAYTONA 600	600		2003		F		
	M SPEED FOUR 600	600		2002		F		
M TT 600	600		2000	2003	F			
M DAYTONA 750 SPORT	750		1991	1992	F			
M DAYTONA 900	900		1993	1996	F			
M DAYTONA SPRINT 900	900		1994	1998	F			
M SPEED TRIPLE 900	900		1994		F			
M TROPHY 900	900		1996	1998	F			
M DAYTONA 955i	955		1997	2000	F			
M DAYTONA 955i	955		2001	2004	F			
M SPEED TRIPLE 955	955		2002		F			
M SPRINT RS 955 double sided swing arm	955		1999	2002	F			
M SPRINT RS 955 double sided swing arm	955		2003	2004	F			

		CC	KW	FROM	TO	FRONT	LEFT
						REAR	RIGHT
	M SPRINT RS 955 single sided swing arm	955		2003	2004	F	
	M SPRINT ST 955	955		1999	2004	F	
	M DAYTONA 1000 SPORT	1000		1991	1992	F	
	M SPRINT GT 1050	1050		2011		F	
	M SPRINT ST 1050 / ABS	1050		2004		F	
	M DAYTONA 1200	1200		1993	1998	F	
	M TROPHY 1200	1200		1996	2001	F	
	M TIGER EXPLORER 1200	1215		2012		F	
	M TIGER EXPLORER XC 1200	1215		2013		F	
	M THUNDERBIRD 1600	1600		2009		F	
	M THUNDERBIRD STORM 1700	1700		2011		F	
	M THUNDERBIRD COMANDER	1700		2014		F	
	M THUNDERBIRD LT	1700		2014		F	
	M THUNDERBIRD NIGHT STORM	1700		2015		F	
	M ROCKET III ROADSTER	2294		2010		F	
	M ROCKET X	2294		2015		F	
	M ROCKET 2300 /Rocket III Classic/Touring/Roadster	2300		2004		F	
YAMAHA	M TZ 125	125		1997		F	
	M TZ 250	250		1989	2001	F	
	M TZR 250 R - SP	250		1989	1992	F	
	M FZR 750 (O W01)	750		1989	1991	F	

FDB569

59.1 x 57.0 x 8.9 mm

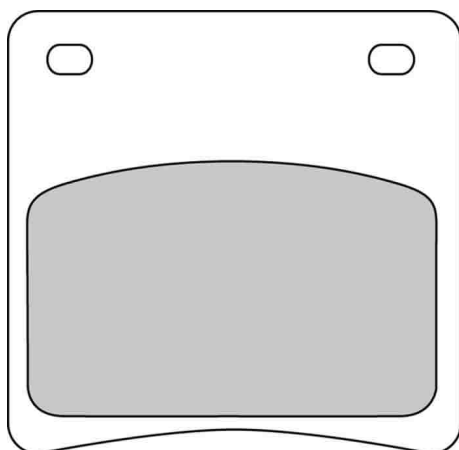

MATERIAL AVAILABILITY											
AG	EF	P	PRP	ST	SM	SG	ZR	XRAC	ZRAC	CP1	CPRO
		✓		✓							

CROSS REFERENCE	
BRAKING	717
BREMBO	07SU13
CL BRAKES	2281
EBC	FA146
GALFER	FD109
LUCAS/TRW	MCB591
NEWFREN	FD0147
SBS	620
VESRAH	VD-345/2

		CC	KW	FROM	TO	FRONT	LEFT
						REAR	RIGHT
SUZUKI	M GSX 600 F KATANA	600		1988	1993	F	
	M GSX 750 FK/FL/FM/FN/FP/FR/FS/FT/FV	750		1989	1997	F	
	M VX 800	800		1990	1994	R	
	M VX 800	800		1995		R	

		CC	KW	FROM	TO	FRONT	LEFT
						REAR	RIGHT
	M GSX 1100 FK - L - M - N - R	1100		1988	1993	F	
	M GSX 1100 FK - L - M - N - R	1100		1988	1993	R	
	M GV 1400 CAVALCADE	1400		1987	1988	F	

FDB570

102.0 x 39.0 x 8.3 mm

MATERIAL AVAILABILITY											
AG	EF	P	PRP	ST	SM	SG	ZR	XRAC	ZRAC	CP1	CPRO
	✓	✓		✓	✓			✓			🔄

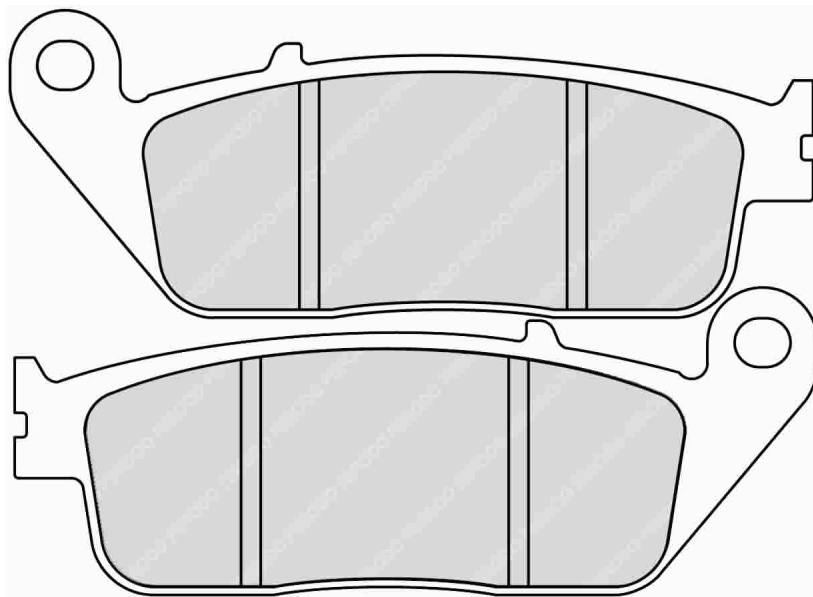

ALSO AVAILABLE		
SHAPE	TH. MM	NOTES
FDB664	9.8	
FDB2225	10.3	
FDB2288	10.5	With Pin

CROSS REFERENCE	
BRAKING	716
BREMBO	07098
BREMBO	07HO30
BREMBO	7074
BREMBO	7075
BREMBO	7098
BRENTA	3059
BRENTA	4059
CL BRAKES	2256
CL BRAKES	3003
CL BRAKES	3065
COBREQ	N-930
EBC	FA142
EBC	FA226
FRAS-LE	PD/870
GALFER	FD266
GOLD FREN	022
LUCAS/TRW	MCB598
LUCAS/TRW	MCB764
LUCAS/TRW	MCB845
NEWFREN	FD0132
NEWFREN	FD0325
SBS	183
SBS	184
SBS	627
VESRAH	VD-156

M = MOTORCYCLE
S = SCOOTER
A = ATV
Sn = SNOWMOBILE

		CC	KW	FROM	TO	FRONT / REAR	LEFT / RIGHT
	M RF 600 RR	600		1993	1997	F	
	S AN 650 BURGMAN Std/Skywave No ABS	650		2003		F	
	S AN 650 BURGMAN Executive/Skywave ABS	650		2004		F	
	M INTRUDER C1500 BT-T	1500		2013		F	
SWM	M Gran Milano	440		2015		F	
	M Silver Vase	440		2015		F	
SYM	M Cevalo B9A (125cc -4T)	125		2010	2010	F	
TRIUMPH	M STREET TRIPLE 675	675		2007	2012	F	
	M STREET TRIPLE 675	675		2013		F	
	M STREET TRIPLE 765 S	765		2017		F	
	M BONNEVILLE 800 (USA version)	800		2001		F	
	M TIGER 800	800	70	2011	2014	F	
	M TIGER 800 XC (A08)	800	70	2011	2014	F	
	M TIGER 800 XC (A082)	800	70	2015	2017	F	
	M TIGER 800 XCx (A082)	800	70	2015	2017	F	
	M TIGER 800 XR (A082)	800	70	2015	2017	F	
	M TIGER 800 XRx (A082)	800		2015	2017	F	

		CC	KW	FROM	TO	FRONT / REAR	LEFT / RIGHT
	M TIGER 800 Xca	800		2015	2017	F	
	M TIGER 800 XRT	800		2017	2017	F	
	M AMERICA LT 865	865		2014		F	
	M SPEEDMASTER 865	865		2004		F	
	M ADVENTURER 900	900		1996	2001	F	
	M ADVENTURER 900	900		1996	2001	R	
	M LEGEND 900 TT	900		1999	2001	F	
	M LEGEND 900 TT	900		1999	2001	R	
	M THRUXTON 900	900		2004	2007	F	
	M THUNDERBIRD 900 / SPORT	900		1995		F	
	M THUNDERBIRD 900 / SPORT	900		1995		R	
	M TIGER 955i	955	77	2001	2006	F	
YAMAHA	M WR 125 R	125		2009	2013	F	
	M WR 125 X (Supermoto)	125		2009		F	
	M WR 250 X (Supermotard) (32D2/4)	250		2008	2010	F	
	M MT-01	1670		2005	2006	R	
	M MT-01	1670		2007		R	

FDB574

69.9 x 46.1 x 8.3 mm

MATERIAL AVAILABILITY											
AG	EF	P	PRP	ST	SM	SG	ZR	XRAC	ZRAC	CP1	CPRO
	✓	✓	✗	✓				✓	✓	✓	

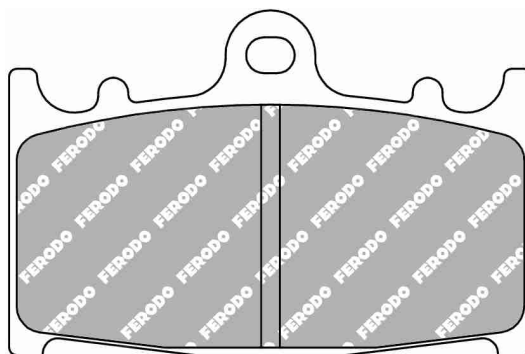

Pinze / Calipers

BERINGER

4 Piston

Moto-Master

4-Piston

Pro-One

Pro-One 4-Piston - New

CROSS REFERENCE

BRAKING	715
BREMBO	07KA13
BRENTA	3062
BRENTA	4062
CL BRAKES	2251
EBC	FA158
GALFER	FD107
GOLD FREN	032
LUCAS/TRW	MCB602
NEWFREN	FD0143
SBS	631
VESRAH	VD-344

		CC	KW	FROM	TO	FRONT / REAR	LEFT / RIGHT
KAWASAKI	M VN 200	200		2007		F	
	M KR-1 250 C1 - C3	250		1990	1992	F	
	M ZXR 400	400		1991		F	
	M ZZR 400	400		1990	1992	F	
	M ZZR 400	400		1993		F	
	M GPZ 500 S	500		1993		F	
	M ZZ-R 500	500		1990		F	
	M ZX 6R 600 D1-D2 (DX 6)	600		1990	1993	F	
	M ZX 6R 600 NINJA	600		1994	1997	F	
	M ZZR 600	600		1990	1992	F	
	M ZZR 600	600		1993		F	
	M ZX-7 750 R NINJA	750		1989	1995	F	
	M ZXR 750	750		1989	1990	F	

		CC	KW	FROM	TO	FRONT / REAR	LEFT / RIGHT
	M ZXR 750 R STINGER / NINJA	750		1991	1992	F	
	M ZXR 750 R	750		1993	1995	F	
	M GPZ 900 R	900		1990	1996	F	
	M X-9 R 900 NINJA	900		1994	1995	F	
	M ZX-9R 900 R NINJA (B1 - B2)	900		1994	1995	F	
	M KLZ VERSYS 1000	1000		2012		F	
	M KLZ VERSYS 1000	1000		2015		F	
	M ZZR 1000	1000		1991		F	
	M ZR 1100 ZEPHYR (ZR 1100 A)	1100		1992	1996	F	
	M ZX 1100	1100		1993		F	
	M ZZR 1100 GT (ZX 1100 C)	1100		1990	1992	F	
	M ZZR 1100 GT (ZX 1100 D)	1100		1993	2001	F	
	M ZZR 1200	1200		2002		F	

M = MOTORCYCLE
S = SCOOTER
A = ATV
Sn = SNOWMOBILE

		CC	KW	FROM	TO	FRONT / REAR	LEFT / RIGHT
	M VN 1700 Voyager (B/BA)	1700		2009		F	
	M VN 1700 Classic&Classic Tourer ABS	1700		2010		F	
	M VN 1700 Voyager Custom (KB)	1700		2011		F	
	M VN 2000 VULCAN / CLASSIC	2000		2004		F	
SUZUKI	M RG 125 T - FV	125		1992	1996	F	
	M RG 200 GAMMA	200		1993	1994	F	
	M COBRA 250	250		1989		F	
	M COBRA 250	250		1990		F	
	M GOOSE 250	250		1992		F	
	M GSX-R 250 R - R/SP	250		1989		F	
	M RGV 250 R	250		1989		F	
	M RGV 250 R	250		1990	1992	F	
	M RGV 250	250		1993		F	
	M RGV 250	250		1994	1996	F	
	M GOOSE 350	350		1992		F	
	M GSF 400 S KATANA	400		1989	1990	F	
	M GSF 400 BANDIT	400		1993	1994	F	
	M GSX 400 KATANA	400		1989	1992	F	
	M GSX-R 400 (V)	400		1989	1990	F	

		CC	KW	FROM	TO	FRONT / REAR	LEFT / RIGHT
	M RGV 500 GAMMA	500		1990		F	
	M GSR 600 /A / ABS	600		2006	2008	F	
	M GSX-R 600 V	600		1996	2003	F	
	M GSF 650 (Naked Bandit Non ABS)	650		2007	2011	F	
	M GSF 650 A (Naked Bandit ABS)	650		2007	2011	F	
	M GSF 650 S (Faired Bandit Non ABS)	650		2007	2011	F	
	M GSF 650 SA (Faired Bandit ABS)	650		2007		F	
	M GSX 650F (NO ABS)	650		2008	2011	F	
	M GSX 650F (ABS)	650		2008		F	
	M GSX-R 750 Y	750		2000	2003	F	
	M SV 1000 K3/SK3	1000		2003		F	
	M TL 1000 SV TWIN	1000		1997	2001	F	
	M GSF 1250 (Naked Bandit - Non ABS)	1250		2007	2011	F	
	M GSF 1250 A (Naked Bandit - ABS)	1250		2007	2010	F	
	M GSF 1250 S (Faired Bandit - Non ABS)	1250		2007	2010	F	
	M GSF 1250 SA (Faired Bandit - ABS)	1250		2007	2012	F	
	M GSF 1250 SA (Faired Bandit - ABS)	1250		2015		F	
	M GSX 1250 FA	1250		2010		F	
	M GSX 1250 FA ST (Sport Touring)	1250		2010		F	

FDB583

71.2 x 39.0 x 9.8 mm

MATERIAL AVAILABILITY

AG	EF	P	PRP	ST	SM	SG	ZR	XRAC	ZRAC	CP1	CPO
		✓									

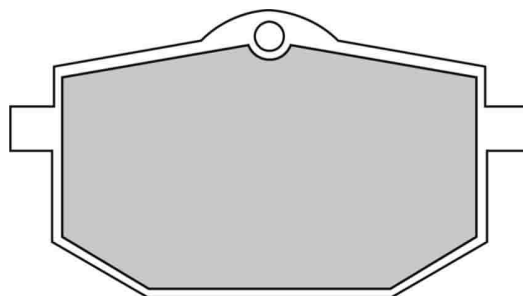

CROSS REFERENCE

BRAKING	683
BREMBO	07YA18
CL BRAKES	2393
COBREQ	N-913
EBC	FA118
FRAS-LE	PD/853
GALFER	FD072
LUCAS/TRW	MCB568
NEWFREN	FD0097
SBS	596
VESRAH	VD-245

		CC	KW	FROM	TO	FRONT / REAR	LEFT / RIGHT
MOTO GUZZI	M NTX 750	750		1990		F	
YAMAHA	M RT 180	180		1990	1992	F	
	M RT 180	180		1993	1994	F	
	M XT 350	350		1988	1990	F	
	M XT 350	350		1991		F	

		CC	KW	FROM	TO	FRONT / REAR	LEFT / RIGHT
	M XT 600 4 VALVES	600		1986	1986	F	
	M XT 600 4 VALVES	600		1987	1989	F	
	M XT 600 Z TENERE	600		1985	1987	F	
	M XT 600 Z TENERE	600		1988	1990	F	

FDB591

80.0 x 42.0 x 10.0 mm

MATERIAL AVAILABILITY											
AG	EF	P	PRP	ST	SM	SG	ZR	XRAC	ZRAC	CP1	CPRO
		✓									

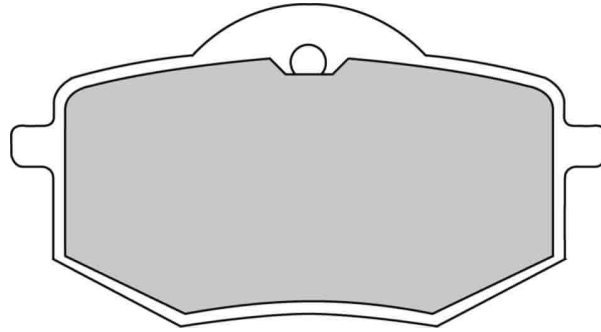

CROSS REFERENCE	
BRAKING	735
BREMBO	07YA19
CL BRAKES	2392
EBC	FA136
GALFER	FD127
LUCAS/TRW	MCB587
NEWFREN	FD0135
SBS	616
VESRAH	VD-246

		CC	KW	FROM	TO	FRONT / REAR	LEFT / RIGHT
	YAMAHA	M	XV 400 VIRAGO	400	1988	F	

		CC	KW	FROM	TO	FRONT / REAR	LEFT / RIGHT
	M	XV 535 VIRAGO	535	1987	1994	F	

FDB592

120.1 x 52.5 x 8.0 mm

MATERIAL AVAILABILITY											
AG	EF	P	PRP	ST	SM	SG	ZR	XRAC	ZRAC	CP1	CPRO
		✓									

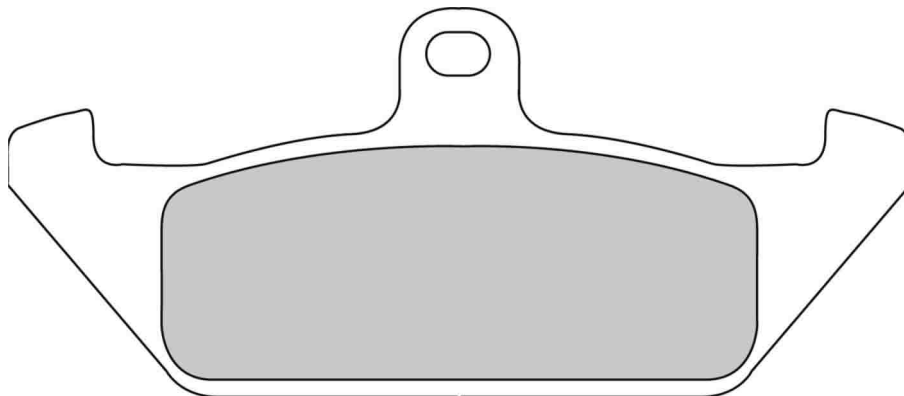

CROSS REFERENCE	
BREMBO	07BB06
CL BRAKES	2801
EBC	FA120
GALFER	FD098
LUCAS/TRW	MCB563
NEWFREN	FD0096
SBS	594
VESRAH	VD-924

M = MOTORCYCLE
S = SCOOTER
A = ATV
Sn = SNOWMOBILE

		CC	KW	FROM	TO	FRONT REAR	LEFT RIGHT
	M ALA AZZURRA 350 GT	350		1987		R	
	M ELEFANT 350	350		1985		F	
	M ELEFANT 650	650		1985		F	
	M DAKAR 750	750		1987		F	
	M ELEFANT 750	750		1987		F	
DUCATI	M ELEFANT 750	750		1988	1989	F	
	M 350 INDIANA	350		1987		F	

		CC	KW	FROM	TO	FRONT REAR	LEFT RIGHT
	M 650 INDIANA	650		1987		F	
	M OR 600	600		1986		R	
MOTO GUZZI	M OR 600 ATLAS	600		1987		F	
	M VT 650 TT BAJA	650		1986		F	
MOTO MORINI	M WS 350 PRO ACTION	350		1993		F	
YAMAHA	M DT 125 CHESTERFIELD SCOUT	125		1988		F	
	M DT 125 LC TENERE	125		1988		F	

FDB605

69.1 x 50.9 x 9.4 mm

MATERIAL AVAILABILITY											
AG	EF	P	PRP	ST	SM	SG	ZR	XRAC	ZRAC	CP1	CPRO
	✓	✓		✓	✓			✓	✓		✓

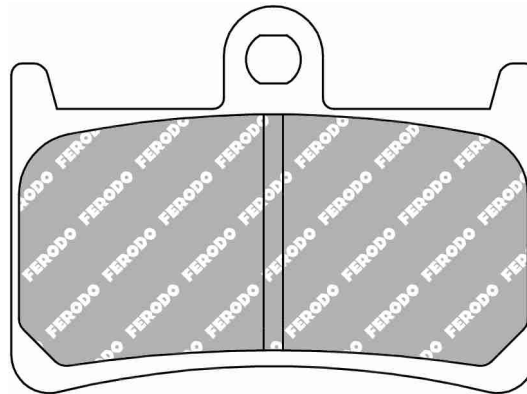

CROSS REFERENCE	
BRAKING	786
BREMBO	07YA23
BRENTA	3094
BRENTA	4094
CL BRAKES	2361
CL BRAKES	3091
EBC	FA252
EBC	FA380HH
EBC	Old FA168
GALFER	FD178
GOLD FREN	070
LUCAS/TRW	MCB611
NEWFREN	FD0190
SBS	198
SBS	634
SBS	639
VESRAH	VD-248
VESRAH	VD-249

		CC	KW	FROM	TO	FRONT REAR	LEFT RIGHT
	M GSX-R 400	400		1990		F	
	M FZR 250 R	250		1989		F	
YAMAHA	M FZR 400 RR - SP	400		1991	1992	F	
	S TMAX 500 (SJ05)	500	32	2008	2011	F	
	S TMAX 500 SV (Tech Max)	500		2011		F	
	S TMAX 500 SV ABS (Tech Max)	500		2011		F	
	M TMAX 530	530		2012		F	
	M TMAX 530 ABS	530		2012		F	
	M TMAX 530 IRON MAX /ABS	530		2015		F	
	S TMAX 530 LUX MAX /ABS	530		2016		F	
	S TMAX 530 DX ABS	530		2017		F	
	S TMAX 530 SX ABS	530		2018		F	
	S TMAX 530 SX ABS SPORT EDITION	530		2018		F	
	S TMAX 560	560		2020		F	

		CC	KW	FROM	TO	FRONT REAR	LEFT RIGHT
	S TMAX 560 Tech	560		2020		F	
	M FZ6 600 S2 / FZ6 600 FAZER S2 ABS	600		2007	2009	F	
	M FZS 600 FAZER	600		1999	2003	F	
	M YZF 600 R THUNDERCAT	600		1996	2003	F	
	M YZF 600 R6	600		1999	2002	F	
	M YZF 600 R6	600		2003	2004	F	
	M YZF 600 R6	600		2005	2016	F	
	M YZF 600 R6	600		2017	2019	F	
	M Tracer 700 ABS	689	55	2018		F	
	M MT-07 (RM04)	700	34	2014		F	
	M MT-07 (RM04)	700	55	2014		F	
	M MT-07 Motocage ABS	700		2015		F	
	M Tracer 700 GT	700	55	2019		F	
	M Tracer 700	700		2020		F	

4094

FERODO
RACING
Updated on November 2020

M = MOTORCYCLE
S = SCOOTER
A = ATV
Sn = SNOWMOBILE



		CC	KW	FROM	TO	FRONT / REAR	LEFT / RIGHT
M	XSR 700 ABS (RM11)	700	55	2016		F	
M	XSR 700 ABS (RM11)	700	35	2016		F	
M	XSR 700 Xtribute	700	55	2019		F	
M	YZF 750 R7 (OW02)	750		1999	2001	F	
M	FAZER 8 (NO ABS/ABS)	800		2011		F	
M	FZ8 NO ABS	800		2011		F	
M	FZ8 ABS	800		2011		F	
M	MT-09 SP ABS	847	85	2018		F	
M	Niken	847	85	2018		F	
M	Niken GT	847	85	2019		F	
M	Tracer 900 ABS	847	85	2018		F	
M	Tracer 900 GT	847	85	2018		F	
M	XSR 900 Abarth ABS	847	85	2018		F	
M	MT-09 (RN29)	850	85	2014		F	
M	MT-09 SR ABS	850		2014		F	
M	MT-09 Sport Tracker ABS	850		2015		F	
M	MT-09 Tracer ABS	850	85	2016	2017	F	
M	MT-09 Street Rally / ABS	850		2016		F	
M	TDM 900	900		2002		F	
M	XSR 900 ABS	900	85	2016		F	
M	MT-10 Tourer ed. ABS	998	118	2018		F	
M	FZ1 1000 (NO ABS/ABS)	1000		2006		F	
M	FZ1 1000 Fazer (NO ABS/ ABS)	1000		2006		F	
M	FZS 1000 FAZER	1000		2001	2005	F	
M	MT-10	1000		2016		F	



		CC	KW	FROM	TO	FRONT / REAR	LEFT / RIGHT
M	MT-10 SP	1000		2017		F	
M	YZF 1000 THUNDERACE	1000		1996	2001	F	
M	YZF 1000 R1	1000		1998	2001	F	
M	YZF 1000 R1	1000		2002	2003	F	
M	YZF 1000 R1	1000		2004	2006	F	
M	YZF 1000 R1	1000		2015		F	
M	YZF 1000 R1M	1000		2015		F	
M	YZF 1000 R1 60th Anniversary	1000		2016		F	
M	BT 1100 BULLDOG	1100		2002		F	
M	XT 1200 ZE Super Tenere' Raid ed.	1199	82	2018		F	
M	XT 1200 ZE ABS (Supertenere)	1200		2014		F	
M	XT 1200 ZE ABS Worldcrosser (Supertenere)	1200		2016		F	
M	XT 1200 Z Super Tenere' (DP01) ABS	1200	81	2010	2013	F	
M	XT 1200 Z Super Tenere' ABS	1200	82	2014		F	
M	XT 1200 Z Super Tenere' ABS Worldcrosser	1200		2016		F	
M	FJR 1300	1300		2001	2002	F	
M	FJR 1300/FJR 1300 A	1300		2003	2005	F	
M	XJR 1300 SP	1300		1999	2001	F	
M	XJR 1300	1300		2001		F	
M	XJR1300 Racer	1300		2015		F	
M	XJR 1300	1300		2015		F	
M	MT-01	1670		2005	2006	F	
M	XV 1700 ROYAL STAR WARRIOR	1700		2002		F	
M	XV 1900 A Midnight Star	1900		2006	2012	F	

M = MOTORCYCLE
S = SCOOTER
A = ATV
Sn = SNOWMOBILE

FDB606

117.0 x 47.0 x 8.6 mm / 97.0 x 57.0 x 11.0 mm

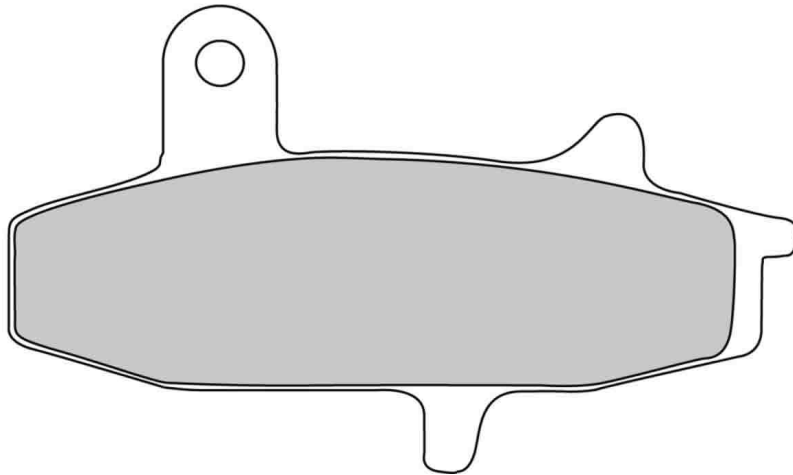
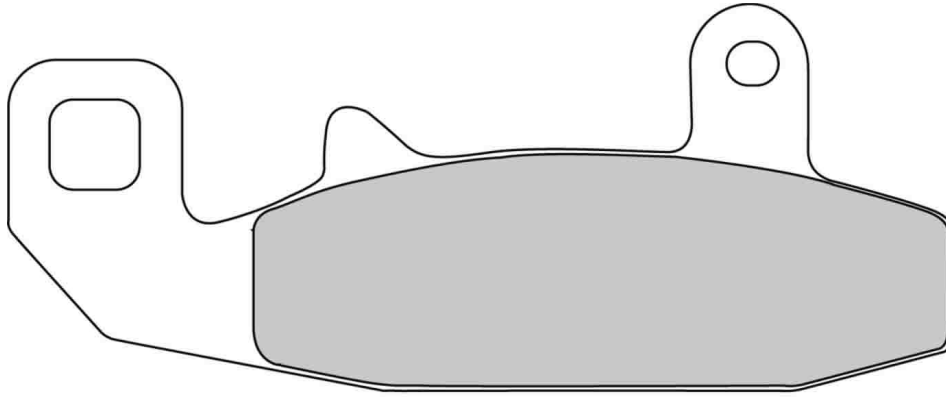

MATERIAL AVAILABILITY

AG	EF	P	PRP	ST	SM	SG	ZR	XRAC	ZRAC	CP1	CPRO
		✓									



CROSS REFERENCE

BRAKING	709
BREMBO	07SU15
CL BRAKES	2308
EBC	FA147
GALFER	FD101
LUCAS/TRW	MCB597
NEWFREN	FD0140
SBS	626
VESRAH	VD-347

		CC	KW	FROM	TO	FRONT REAR	LEFT RIGHT
	HONDA	M	VTZ 250 XELVIS	250		1992	R
	SUZUKI	M	DR 650 R-RS-RSE-DJEBEL-DAKAR	650		1991 1995	F
		M	DR 750 S BIG	750		1988	F

		CC	KW	FROM	TO	FRONT REAR	LEFT RIGHT
		M	DR 750 S BIG	750		1989	F
		M	DR 800 Z	800		1988 1989	F
		M	DR 800 BIG S - SU	800		1990	F

FDB607

99.0 x 44.0 x 7.4 mm / 84.0 x 47.0 x 9.8 mm

MATERIAL AVAILABILITY

AG	EF	P	PRP	ST	SM	SG	ZR	XRAC	ZRAC	CP1	CPRO
		✓									

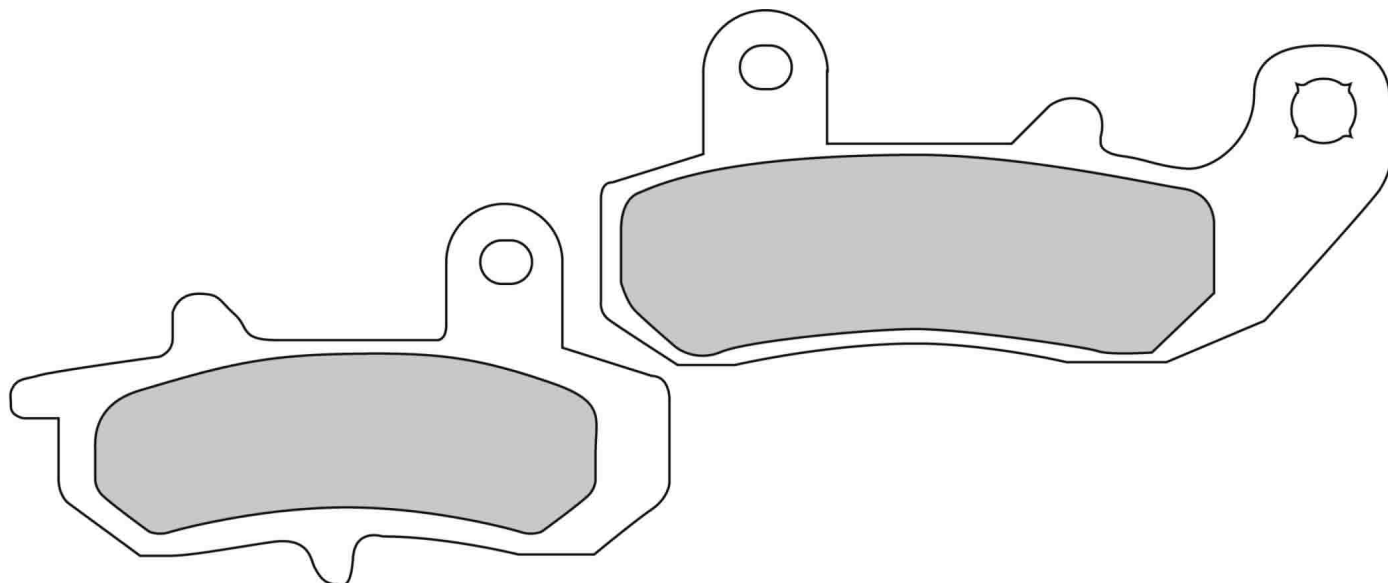

CROSS REFERENCE

BRAKING	728
BREMBO	07SU17
CL BRAKES	2388
EBC	FA157
GALFER	FD120
LUCAS/TRW	MCB612
NEWFREN	FD0164
SBS	635
VESRAH	VD-348

		CC	KW	FROM	TO	FRONT / REAR	LEFT / RIGHT
	SUZUKI						
M	RG 125 U WOLF	125		1992	1994	R	
M	RG 125 T - FV	125		1992	1996	R	
M	RG 200 GAMMA	200		1993	1994	R	
M	RG 200 WOLF	200		1993	1994	R	
M	RGV 250	250		1993		R	

		CC	KW	FROM	TO	FRONT / REAR	LEFT / RIGHT
							
M	DR 600 DJEBEL - DAKAR	600		1989		R	
M	DR 650 RS-R DAKAR	650		1990		R	
M	DR 650 R-RS-RSE-DJEBEL-DAKAR	650		1991	1995	R	
M	DR 750 S BIG	750		1989		R	
M	DR 800 BIG S - SU	800		1990		R	

M = MOTORCYCLE
S = SCOOTER
A = ATV
Sn = SNOWMOBILE

FDB624

35.3 x 51.7 x 7.1 mm

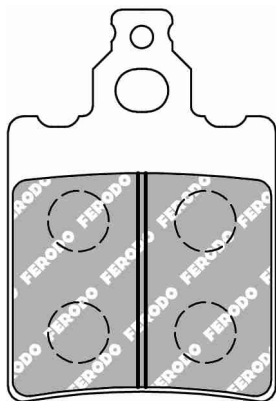



MATERIAL AVAILABILITY											
AG	EF	P	PRP	ST	SM	SG	ZR	XRAC	ZRAC	CP1	CPRO
✓											



ALSO AVAILABLE

SHAPE	TH. MM	NOTES
FDB694	6.1	

CROSS REFERENCE

BREMBO	07GR13
EBC	FA060
EBC	FA127
NEWFREN	FD0103
SBS	574

		CC	KW	FROM	TO	FRONT / RÉAR	LEFT / RIGHT
	APRILIA	M	RX 50	50	1992	1995	R
		M	RX 50	50	1996	1998	R
		M	TUAREG 50	50	1987		R
	BETA	M	KR 50 ADVENTURE	50	1987		R
		M	KR 50	50	1987		R
	FANTIC	M	OASIS 50 .1	50	1986		R
		M	OASIS 50 .1 E.S.	50	1987		R

		CC	KW	FROM	TO	FRONT / RÉAR	LEFT / RIGHT
	GARELLI	M	SPORT 125 HP1 (FM.265)	125	1985		F
		M	TIGER 125 XLE	125	1986	1986	R
	KEEWAY	M	TX50	50	2010	2012	R
	KSR MOTO BY GENERIC	S	Toxic 50	50	2007	2008	R
		M	Trigger 125 SM	125	2008	2009	R
	M	Trigger 125 X	125	2008	2009	R	

FDB625

41.0 x 43.0 x 7.7 mm

February 2017: AG superseded by EF

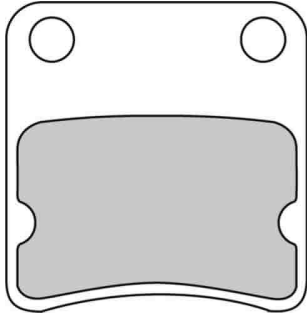

MATERIAL AVAILABILITY											
AG	EF	P	PRP	ST	SM	SG	ZR	XRAC	ZRAC	CP1	CPRO
X	✓										

CROSS REFERENCE	
BRAKING	757
BREMBO	07032
BREMBO	07HO38
BREMBO	7032
BRENTA	3132
BRENTA	4132
CL BRAKES	2408
CL BRAKES	3018
CL BRAKES	3038
EBC	Old FA178
EBC	SFA257
GALFER	FD149
LUCAS/TRW	MCB647
NEWFREN	FD0173
SBS	115
SBS	670
VESRAH	VD-162

		CC	KW	FROM	TO	FRONT REAR	LEFT RIGHT
	BS VILLA	M	ZX 50	50	1993		F
	CAGIVA	M	CITY 50	50	1992	1994	F
	HONDA	M	GP 50 DIO	50	1991	1995	F
		M	SR 50 DIO	50	1990		F
		M	SR 50 LIFE DIO	50	1994		F
		M	SUPER DIO 50 SR	50	1991	1992	F
		M	SUPER DIO 50 ZX	50	1992		F
		M	XR 50 DIO BAJA	50	1994		F
		M	YUPY 50	50	1992		F
		M	ZX 50 LIFE DIO	50	1994		F
		M	ZX DIO 50	50	1995		F
		M	TUR/ML 125 (Brasil)	125			F

		CC	KW	FROM	TO	FRONT REAR	LEFT RIGHT
		M	CBX 200 STRADA	200	13		F
HSC	M	HSC 01 50	50	1992			F
	M	SR 50 DIO	50	1992			F
	M	ZR 50	50	1992			F
	M	ZX 50 DIO	50	1992			F
SYM	M	CITY HOPPER 50	50	1999	2002		F
	M	DD 50 CITY TREK	50	2002			F
	S	Orbit 50	50	2008	2009		F
	M	SUPER FANCY 50	50	1996	2002		F
	M	CINDERELLA 50 / 100	100	1999	2000		F
	S	Orbit 125	125	2008	2009		F

M = MOTORCYCLE
S = SCOOTER
A = ATV
Sn = SNOWMOBILE

FDB631

96.8 x 42.2 x 7.6 mm / 76.5 x 42.2 x 7.6 mm

May 2020: CP1 Out of range

MATERIAL AVAILABILITY											
AG	EF	P	PRP	ST	SM	SG	ZR	XRAC	ZRAC	CP1	CPRO
✓	✓	✓		✓	✓	✓					

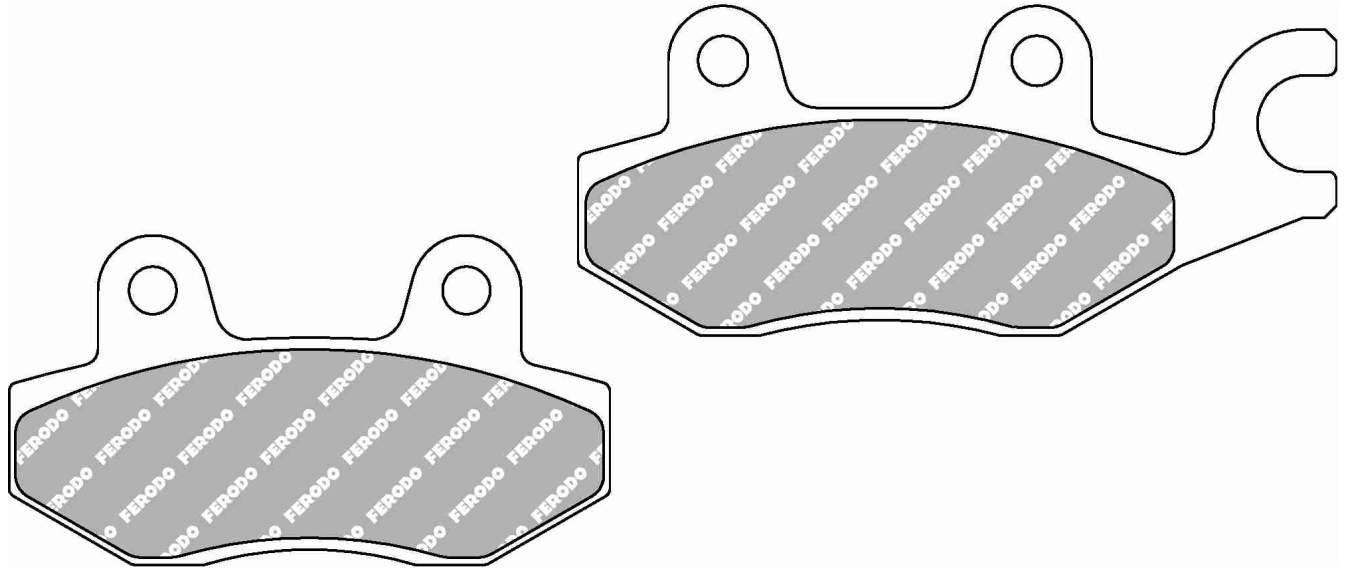

ALSO AVAILABLE		
SHAPE	TH. MM	NOTES
FDB497		Coupled set
FDB2087	8.8	with slot

CROSS REFERENCE	
BRAKING	725
BREMBO	07YA20
BREMBO	07YA22
BREMBO	7071
BRENTA	3064
BRENTA	4064
CL BRAKES	2326
CL BRAKES	3036
CL BRAKES	3086
COBREQ	N-940
EBC	FA165
FRAS-LE	PD/861
GALFER	FD117
GOLD FREN	009
GOLD FREN	088
LUCAS/TRW	MCB615
NEWFREN	FD0163
SBS	134
SBS	633
SBS	638
SBS	688
VESRAH	VD-250



		CC	KW	FROM	TO	FRONT / REAR	LEFT / RIGHT
BENELLI	M Caffe Nero 250	250		2008	2011	F	left
CAGIVA	M CANYON 500	500		1995		R	
	M CANYON 600	600		1996	1997	R	
	M CANYON 900 I.E.	900		1997		R	
	M ELEFANT 900 I.E.- GT - AC	900		1991		R	
	M GRAN CANYON 900	900		1999		R	
	M ELEFANT 906	906		1990		R	
	M NAVIGATOR / NAVIGATOR T	1000		2000	2005	R	
	M NAVIGATOR 1000	1000		2001		R	
CFMOTO	A CF 500-5 (Rancher 500 UTV)	500		2010	2012	F	right
	A CF 500 (Terracross)	500		2011	2012	F	left
	A CF 500 UU-A UForce - side by side	550		2015	2015	F	right
	A CF 600 ZForce / ZForce EX - side by side	600		2013	2015	F	right
	A CF 625-3 (Z6 Terracross)	625		2011	2012	F	left
	A CF 800 UU-A UForce - side by side	800		2013	2015	F	right
	A CF 800 EX ZForce - side by side	800		2015		F	right
CPI ATV	A 250 XS	250		2006		R	
DAELIM	M ROADWIN 125	125		2004		R	
E-TON ATV	A CXL 150 Yukon II/Challenger	150		2002	2009	R	
	A RXL 150 Viper R	150		2005	2009	R	
	A RXL 150 Viper	150		2005	2006	R	
HONDA	M NSR 50	50		1994	2000	F	
	M NSR 80 R	80		1993	1998	F	
	M SUPRA 100	100		1999		F	
	M CB 125 F	125	7	2015	2016	F	
	M VT 125 SHADOW	125		1999		F	
	M XL 125 VARADERO	125		2001		F	
	M NSR 150	150		2001	2003	F	
	M TA 200	200		2003	2004	F	
	M TA 200	200		2003	2004	R	
HYOSUNG	M Electric GEM 4.0			2010		F	
	M Electric GEM 4.0			2010		R	
	M MS3 125	125		2006		F	right
	M MS3 125	125		2006		R	
	M MS3 250	250		2006		F	right
	M MS3 250	250		2006		R	
JONWAY	S YY 125	125		2008	2009	F	
	S YY 125	125		2008	2009	R	
	S YY 150	150		2008	2009	F	
	S YY 150	150		2008	2009	R	
	S YY 250/250 A	250		2008	2009	F	
	S YY 250/250 A	250		2008	2009	R	
KAWASAKI	M KAZER 115 R	115		1998	1999	F	
	M BN 125 A3/A4 ELIMINATOR	125		2000		F	
	M Ninja	125	11	2019		F	
	M Ninja	125	11	2019		R	
	M Z 125	125	11	2019		F	
	M Z 125	125	11	2019		R	
	M NINJA 250R (EX250K)	250		2008	2012	F	
	M NINJA 250R (EX250K)	250		2008	2012	R	
	M NINJA 250SL (BX250A)	250		2015		F	
	M NINJA 250SL (BX250A)	250		2015		R	
	M Z250SL (BR250E)	250		2015		F	
	M Z250SL (BR250E)	250		2015		R	
	M NINJA 300 (EX300A)	300		2013		F	
	M NINJA 300 (EX300A)	300		2013		R	
	M Versys-x	300		2017		R	
	M Z300	300		2015		F	
	M Z300	300		2015		R	
	M Ninja 400	399	33	2018		F	
	M Ninja 400	399	33	2018		R	
	M Z 400	399	33	2019		F	
	M Z 400	399	33	2019		R	
	M KLR 650	650		2008		R	



		CC	KW	FROM	TO	FRONT / REAR	LEFT / RIGHT
KAWASAKI ATV	A KLF 300 BAYOU 4x4 C Series (right)	300		1989	2004	F	
	A KLF 400 BAYOU 4x4 B Series (right)	400		1993	1999	F	
	A KVF 650 Brute Force 4X4i All models	650		2007	2008	F	right
	A KRF 750 Teryx 4x4 All mod.-side by side	750		2008		F	right
	A KVF 750 BRUTE FORCE All Models	750		2005	2010	F	right
KEEWAY	M 250 Blackster	250		2014		R	
KYMCO	S LIKE LX 125 4T	125		2010		R	
	S LIKE LX 200 i	200		2010		R	
	M PEOPLE 250 S	250		2006	2008	F	right
	S PEOPLE S 300 i	300		2008	2010	R	
	S PEOPLE S 300 i	300		2008	2010	F	right
MODENAS	M KRISS 115	115		1999		F	
QUADZILLA	A RS 6 4WD Right	600		2010	2011	F	
SUZUKI	S UH 125 BURGMAN ABS	125		2014		F	
	S UH 200 BURGMAN ABS	200		2014		F	
	M AN 250 Skywave Type M (BA-CJ45A)	250		2007	2008	F	right
	M AN 250 Skywave Type S (BA-CJ44A)	250		2007	2008	F	right
	M AN 250 8 Skywave SS	250		2008		F	right
	M AN 400 BURGMAN/SKYWAVE NO ABS	400		2007		F	right
	M AN 400 BURGMAN/SKYWAVE ABS	400		2007		F	right
	S BURGMAN 400 ABS	400		2017		F	right
	M DR 800 BIG all models	800		1991		R	
SUZUKI ATV	A LT-F 300 KING QUAD	300		2002		F	right
	A LT-R 450 K/Z	450		2006		F	right
	A LT-A 500 F QUADMASTER	500		2000	2001	F	right
	A LT-F 500 FW/FX/F1 QUADRUNNER (right)	500		1998	2002	F	
TRIUMPH	M DAYTONA 750 SPORT	750		1991	1992	R	
	M TRIDENT 750	750		1992	1998	R	
	M TRIDENT 750	750		1992	1998	F	right
	M DAYTONA 900	900		1993	1996	R	
	M DAYTONA SPRINT 900	900		1993		F	right
	M DAYTONA SPRINT 900	900		1993		R	
	M DAYTONA SPRINT 900	900		1994	1998	R	
	M DAYTONA SUPER III 900	900		1994	1997	R	
	M SPEED TRIPLE 900	900		1994		R	
	M TIGER 900	900		1993	1998	R	
	M TIGER 900	900		1993	1998	F	right
	M TRIDENT 900 SPRINTER	900		1993	1998	R	
	M TRIDENT 900 SPRINTER	900		1993	1998	F	right
	M TROPHY 900	900		1993	1995	F	right
	M TROPHY 900	900		1993	1995	R	
	M TROPHY 900	900		1996	1998	R	
	M SPRINT RS 955 double sided swing arm	955		1999	2002	R	
	M TIGER 955i	955	77	2001	2006	R	
	M DAYTONA 1000 SPORT	1000		1991	1992	R	
	M TIGER SE ABS 1050	1050		2008		R	
	M TIGER SPORT	1050		2013		R	
	M DAYTONA 1200	1200		1993	1998	R	
	M TROPHY 1200	1200		1993	1995	F	right
	M TROPHY 1200	1200		1993	1995	R	
	M TROPHY 1200	1200		1996	2001	R	
YAMAHA	M FZR 50	50		1990	1991	F	
	M TZR 50	50		1997	2003	F	
	M YBR 250	250	15	2006	2013	F	
	M XTZ 750 SUPER TENERE	750		1989		F	right
	M XTZ 750 SUPER TENERE	750		1989		R	
YAMAHA ATV	A YFZ 450	450		2004	2005	F	right
	A YFZ 450 - All models	450		2006		F	right
	A YXR 450 RHINO - side by side	450		2004	2009	F	right
	A YXR 660 RHINO - side by side	660		2004	2007	F	right
	A YFM 700 RAPTOR - All Models	700		2006		F	right
	A YXR 700 RHINO - side by side	700		2008		F	left
	A YXR 700 RHINO - side by side	700		2008		R	left

M = MOTORCYCLE
S = SCOOTER
A = ATV
Sn = SNOWMOBILE

FDB636

61.0 x 27.0 x 7.3 mm

July 2016:AG superseded by EF

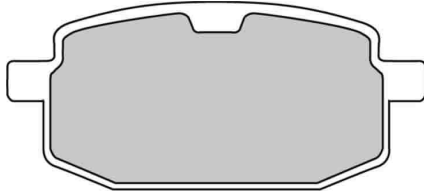

MATERIAL AVAILABILITY											
AG	EF	P	PRP	ST	SM	SG	ZR	XRAC	ZRAC	CP1	CPRO
X	✓	✓									

CROSS REFERENCE	
BRAKING	744
BREMBO	07041
BREMBO	07YA30
BREMBO	7041
BRENTA	3076
BRENTA	4076
CL BRAKES	2696
CL BRAKES	3029
CL BRAKES	3030
EBC	FA169
EBC	SFA169
GALFER	FD136
LUCAS/TRW	MCB590
NEWFREN	FD0175
SBS	111
SBS	619
VESRAH	VD-247

		CC	KW	FROM	TO	FRONT / REAR	LEFT / RIGHT
	ADLY	S	Jet 50	50	1996	F	
		S	Pista 50	50	1996	F	
		S	Predator 50	50	2000	F	
		S	Jet 100	100	1996	F	
		S	Predator 100	100	2000	F	
	BETA	M	R 125 4T (Pit Bike)	125	2008	F	
BS VILLA	M	AX 50	50	1993	F		
	M	GZ 50	50	1993	F		
FANTIC	M	BIG WHEEL 50	50	1994	F		
	M	GRINTA 50	50	1995	F		
	M	LEADER 50	50	1995	F		
	M	PONY 50 SR	50	1993	F		
	M	QUEENIE 50	50	1995	F		
GARELLI	M	BIG WHEEL 50	50	1993	1994	F	
	M	BIP RACING 50	50	1994	F		
	M	GRINTA	50	1995	F		
	M	PONY 50 SR	50	1992	1995	F	
	M	QUEENIE	50	1995	F		
ITALJET	M	BAZOOKA 2 50	50	1992	1997	F	
	M	CRUISE 50	50	1995	1998	F	
	M	PISTA 2 50	50	1992	1996	F	
	M	SCOOP 50	50	1993	F		
	M	YANKEE 8 50	50	1994	F		
MALAGUTI	M	BLOG 125	125	2008	R		
	M	BLOG 160	160	2008	R		

		CC	KW	FROM	TO	FRONT / REAR	LEFT / RIGHT
	MBK	M	TARGET 50	50	1992	F	
		M	BOOSTER 100	100	2000	2002	F
	PEUGEOT	S	V-Clic 50 (4T)	50	2008	2011	F
PGO	M	BIG MAX 50	50	1995	2004	F	
	S	EPS	50	1997	F		
	S	Tornado 50	50	1997	F		
	S	Tornado 125	125	1997	F		
SINNIS	S	QM 50 QT-2T Falcon	50	2008	2010	F	
	S	QM 50 QT-6A Jet 50	50	2008	2010	F	
YAMAHA	M	50 AXIS	50	1993	F		
	M	50 AXIS PROFOOT	50	1994	F		
	M	CR 50 TARGET	50	1991	F		
	M	CR 50 Z	50	1992	F		
	M	JOG 50 (Espana)	50	1988	F		
	M	JOG 50 (Italia)	50	1993	F		
	M	RS 50 CHAMP	50	1988	F		
	M	50 TRUNK	50	1994	F		
	M	TZM 50 R	50	1994	F		
	M	TZR 50	50	1990	1996	F	
M	TZR 80	80	1992	F			
	M	90 AXIS (Brasil)	90		F		
	M	CR 90 TARGET	90	1991	F		
	M	JOG 90 (Brasil)	90		F		
	M	JOG 90	90	1990	1994	F	
	M	BW' S 100	100	2000	2002	F	

FDB637

74.8 x 55.0 x 10.9 mm

MATERIAL AVAILABILITY

AG	EF	P	PRP	ST	SM	SG	ZR	XRAC	ZRAC	CP1	CPRO
		✓		✓							

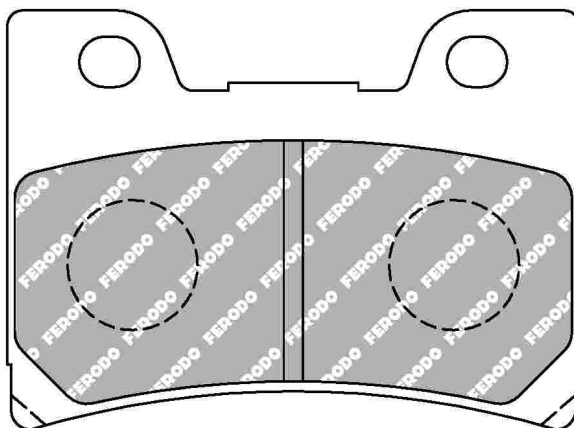

ALSO AVAILABLE

SHAPE	TH. MM	NOTES
FDB666		5 mm Pin Holes

CROSS REFERENCE

BRAKING	751
BREMBO	07YA26
CL BRAKES	2309
EBC	FA182
GALFER	FD143
LUCAS/TRW	MCB642
NEWFREN	FD0176
SBS	665
VESRAH	VD-257



YAMAHA | M | FZR 600 R

CC KW FROM TO FRONT REAR LEFT RIGHT
600 | | 1991 | 1995 | F |



M | FZR 1000 EX-UP

CC KW FROM TO FRONT REAR LEFT RIGHT
1000 | | 1991 | 1993 | F |

FDB659

62.1 x 40.9 x 9.4 mm

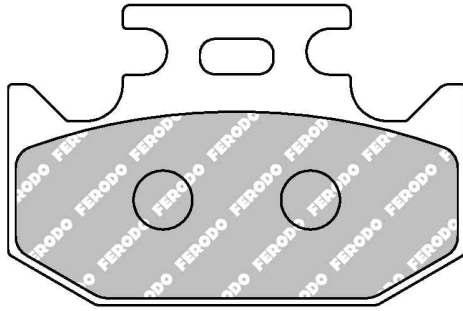



MATERIAL AVAILABILITY											
AG	EF	P	PRP	ST	SM	SG	ZR	XRAC	ZRAC	CP1	CPR0
	✓	✓				✓					

ALSO AVAILABLE

SHAPE	TH. MM	NOTES
FDB2270	7.1	

CROSS REFERENCE

BRAKING	722
BREMBO	07KA12
BREMBO	07SU18
BRENTA	3086
BRENTA	4086
CL BRAKES	2299
EBC	FA152
GALFER	FD114
GOLD FREN	001
LUCAS/TRW	MCB625
NEWFREN	FD0144
SBS	632
SBS	648
VESRAH	VD-432
VESRAH	VD-432/2

		CC	KW	FROM	TO	FRONT REAR	LEFT RIGHT
	CANNONDALE						
	M MX 400	400		2000	2002	R	
	M 440 (All Enduro / MX Models)	440		2003		R	
	M S 440 SUPERMOTO	440		2003		R	
	KAWASAKI						
	M KDX 125 A1	125		1990	1994	R	
	M KX 125	125		1989	1994	R	
	M KX 125 K2-K4	125		1995	1997	R	
	M KDX 200 E1	200		1989		R	
	M KDX 200 SR	200		1990	1993	R	
	M KDX 200 E6 / H1 - H3	200		1994	2003	R	
	M KDX 220 RA4	220		1997	2003	R	
	M KDX 250 SR-D	250		1991	1993	R	
	M KLX 250	250		1993	1997	R	
	M KX 250	250		1989	1993	R	
	M KX 250	250		1994	1995	R	
	M KR 500 ES	500		1993		R	
	M KX 500	500		1989	1994	R	
	M KX 500	500		1994	1995	R	
	M KLX 600 R	600		1993		R	
	M KLX 650 R	650		1993	1997	R	
	SUZUKI						
	M RM 125 K - L - M	125		1989	1995	R	
	M TS 125 RK	125		1989		R	
	M TS 200 R	200		1990	1994	R	
	M DJEBEL 250	250		1993		R	
	M DR 250 S	250		1990	2000	R	
	M RM 250	250		1991	1992	R	
M RM 250 K - L - M	250		1989	1994	R		
M RM 250 R-S	250		1993	1995	R		

		CC	KW	FROM	TO	FRONT REAR	LEFT RIGHT
	YAMAHA						
	M RMX 250 RP	250		1989	1995	R	
	M RMX 250 T/V	250		1996	1998	R	
	M RMX 250	250		2000	2002	R	
	M DR 350	350		1990		R	
	M DR 350 S-SH-SE	350		1993	1997	R	
	M DR 650 SE	650		1996		R	
	M FZR 50	50		1992		R	
	M MT-125	125		2020		R	
	M WR 125	125		1990		R	
	M WR 125	125		1991	1992	R	
	M YZ 125 all models	125		1990	1997	R	
	M YZF-R 125	125		2019		R	
	M DT 200 WR	200		1991		R	
	M WR 200 B	200		1991	1994	R	
	M SEROW 225 XT	225		1993	1995	R	
	M SEROW 250 (3C51/52)	250		2005		R	
M TT 250 R	250		1993	1999	R		
M TY 250 Z SCOTTISH	250		1996		R		
M WR 250 (Z 2T)	250		1991	1997	R		
M XG 250 TRICKER (5XT1)	250		2004	2006	R		
M XT 250 X	250		2006	2008	R		
M YZ 250 A - B	250		1990	1992	R		
M YZ 250	250		1990	1997	R		
M WR 400 F	400		1998		R		
M WR 500 ZD - ZE	500		1992	1993	R		
M TT 600	600		1993		R		
M TT 600 R (SPORTKIT)	600		1994	1997	R		

FDB661

46.0 x 45.0 x 6.5 mm

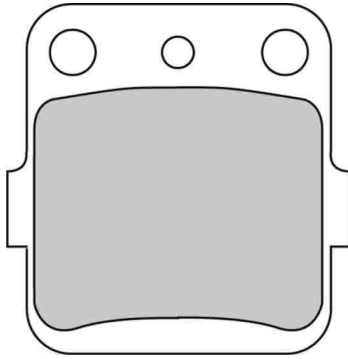





MATERIAL AVAILABILITY											
AG	EF	P	PRP	ST	SM	SG	ZR	XRAC	ZRAC	CP1	CPRO
		✓				✓					



ALSO AVAILABLE

SHAPE	TH. MM	NOTES
FDB381	7.3	

CROSS REFERENCE

BREMBO	07HO22
CL BRAKES	2328
EBC	FA084/3
GALFER	FD299
LUCAS/TRW	MCB554
NEWFREN	FD0123
SBS	584
VESRAH	VD-127

		CC	KW	FROM	TO	FRONT / REAR	LEFT / RIGHT
	HONDA						
	M CR 80 R	80		1986	1991	F	
	M CR 80 R	80		1992	1995	F	
	M CR 80 R/RB	80		1996	2002	F	
	HUSQVARNA						
	M 125 ALL MODELS 1993	125		1993	1993	R	
	M 250 ALL MODELS 1993	250		1993	1993	R	
	KAWASAKI						
	M KX 80 S1 - V1	80		1992		F	
	KAWASAKI ATV						
	A KSF 250 A8 - A9	250		1994	1995	R	
	SUZUKI						
	M RM 125 J	125		1988		R	
	M TS 240 X	240		1988	1990	F	
	M RM 250 H	250		1987	1988	R	
	M RM 500	500		1987		R	

		CC	KW	FROM	TO	FRONT / REAR	LEFT / RIGHT
	SUZUKI						
	M DR 800 Z	800		1988	1989	R	
	SUZUKI ATV						
	A LT 230 S QUADSPORT	230		1985	1988	R	
	TM						
	M 80 Minicross/Junior	80		1996	2000	R	
	M 85 Minicross/Junior	85		1996	2000	R	
	YAMAHA						
	M YZ 65	65		2018		R	
	M YZ 80	80		1993	2001	R	
	M YZ 85 LW	85		2002		R	
	M YZ 125	125		1989		R	
	M YZ 250	250		1989		R	
	M YZ 360	360		1989		R	

M = MOTORCYCLE
S = SCOOTER
A = ATV
Sn = SNOWMOBILE

FDB662

74.9 x 54.8 x 8.8 mm

MATERIAL AVAILABILITY

AG	EF	P	PRP	ST	SM	SG	ZR	XRAC	ZRAC	CP1	CPRO
		✓		✗							

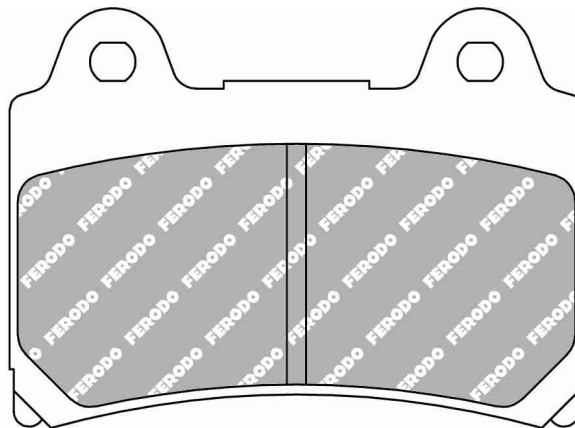

ALSO AVAILABLE

SHAPE	TH. MM	NOTES
FDB449	10.7	

Pinze / Calipers

FLORIDA Caliper

4-Piston (Th. 8.8mm)

CROSS REFERENCE

BRAKING	692
BREMBO	07YA35
CL BRAKES	2253
GALFER	FD087
LUCAS/TRW	MCB584
NEWFREN	FD0177
SBS	613
VESRAH	VD-242/3
VESRAH	VD-257

		CC	KW	FROM	TO	FRONT REAR	LEFT RIGHT
	M XJ 900 F DIVERSION	900		1995		F	
	M FJ 1200	1200		1988	1989	F	
	M FJ 1200 ABS	1200		1991	1995	F	

		CC	KW	FROM	TO	FRONT REAR	LEFT RIGHT
	M XJR 1200	1200		1994		F	
	M XVZ 1300 AH/ATH ROYAL STAR	1300		1996	2001	F	

FDB663

88.1 x 46.1 x 9.8 mm

MATERIAL AVAILABILITY											
AG	EF	P	PRP	ST	SM	SG	ZR	XRAC	ZRAC	CP1	CPRO
	✓	✓		✓							

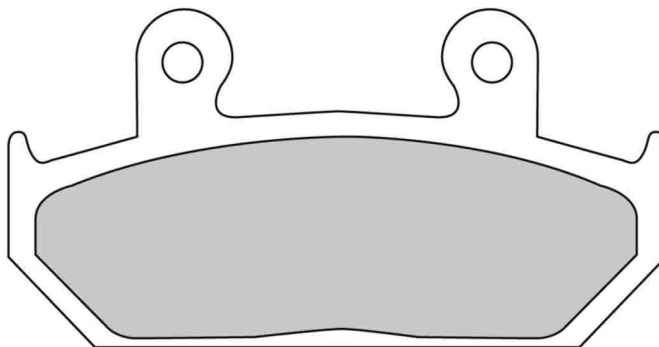

ALSO AVAILABLE		
SHAPE	TH. MM	NOTES
FDB452	8.5	
FDB2173	8.5	pin on the backplate

CROSS REFERENCE	
BRAKING	690
BREMBO	07HO35
CL BRAKES	2248
EBC	FA124/2
GOLD FREN	024
LUCAS/TRW	MCB624
NEWFREN	FD0105
SBS	647
VESRAH	VD-143/2

		CC	KW	FROM	TO	FRONT REAR	LEFT RIGHT
	M CANYON 600	600		1996	1997	F	
	M ELEFANT 750	750		1994		F	
	M CANYON 900 I.E.	900		1997		F	
	M ELEFANT 900 I.E.- GT - AC	900		1991		F	
	M ELEFANT 906	906		1990		F	
HONDA	M CB 125 TT	125		1990		F	
	M CD 250	250		1988	1992	F	
	M NV 400 CUSTOM	400		1988		F	
	M NX 500 DOMINATOR	500		1988	1996	F	
	M NV 600 C	600		1988		F	
	M VLX 600 SHADOW	600		1988	1991	F	

		CC	KW	FROM	TO	FRONT REAR	LEFT RIGHT
	M VT 600 C SHADOW	600		1988	1993	F	
	M XL 600 V TRANSALP	600		1991	1993	F	
	M NX 650 DOMINATOR	650		1988	1992	F	
	M XRV 650 AFRICA TWIN (RD03)	650	37	1988	1990	F	
	M CBR 750 SUPER AERO	750		1988	1989	F	
	M CBR 750 F HURRICANE	750		1987	1988	F	
	M VFR 750 F INTERCEPTOR	750		1986	1987	F	
	M GL 1520 / 6 GOLD WING	1500		1988	1991	F	
	M GL 1500 GOLD-ASPENCADE	1500		1992		F	
	M GL 1500 SE GOLD WING	1500		1993	2000	F	

M = MOTORCYCLE
S = SCOOTER
A = ATV
Sn = SNOWMOBILE

FDB664

102.1 x 39.1 x 9.8 mm

replacing FDB2131

MATERIAL AVAILABILITY											
AG	EF	P	PRP	ST	SM	SG	ZR	XRAC	ZRAC	CP1	CPRO
	✓	✓		✓							

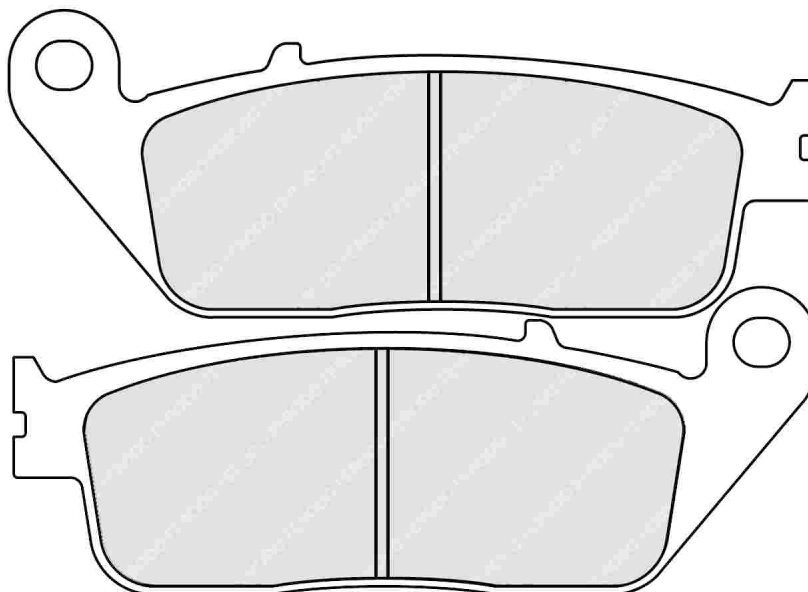

ALSO AVAILABLE		
SHAPE	TH. MM	NOTES
FDB570	8.3	
FDB2225	10.3	
FDB2288	10.5	With Pin

CROSS REFERENCE	
BRAKING	720
BREMBO	07HO31
BREMBO	07HO41
BRENTA	3071
BRENTA	3140
BRENTA	4071
BRENTA	4140
CL BRAKES	2313
CL BRAKES	3059
COBREQ	N-915
EBC	FA196
FRAS-LE	PD/855
GALFER	FD140
GOLD FREN	014
LUCAS/TRW	MCB599
LUCAS/TRW	MCB677
NEWFREN	FD0130
SBS	630
SBS	700

		CC	KW	FROM	TO	FRONT / REAR	LEFT / RIGHT
	BUELL	M	Blast 500	500	2000	2007	F
	CAGIVA	M	900 CAT	900	1993		R
		M	NAVIGATOR 1000	1000	2001		F
	DAELIM	M	ROADWIN 125	125	2004		F
		M	ROCKET 125	125	1999	2001	F
		M	VL 125 DAYSTAR	125	2003		F
		M	VS 125 CUSTOM	125	2001		F
		M	VT 125 MAGNA	125	1997		F
	HONDA	M	VTR 250 (MC33)	250	1998	2009	F

		CC	KW	FROM	TO	FRONT / REAR	LEFT / RIGHT
		M	CBR300R	300	2014		F
		M	CBF 500	500	2004		F
		M	CBR 500 R	500	35	2016	F
		M	CBF 600 S/ABS	600	2011		F
		M	CBR 600 F3	600	1995	1998	F
		M	CBR 600 F / ABS	600	2011		F
		M	CBR 650 F	650	2014		F
		M	FMX 650	650	2005	2006	F
		M	FMX 650	650	2007		F



		CC	KW	FROM	TO	FRONT / REAR	LEFT / RIGHT
M	CTX700	700		2014		F	
M	CTX700N	700		2014		F	
M	NC 700 S,X (man.gearbox - No ABS)	700		2012		F	
M	NC 750 X Travel Edition	745	40	2018		F	
M	750 BLACK WIDOW	750		2001		F	
M	CB 750 NIGHTHAWK	750		1991		F	
M	NC 750 S DCT	750		2014		F	
M	NC 750 X (RC72)	750	35	2014	2015	F	
M	NC 750 X (RC72)	750	40	2014	2015	F	
M	NC 750 X (RC90)	750	40	2016		F	
M	VFR 750 F INTERCEPTOR	750		1988	1989	F	
M	VFR 750 F INTERCEPTOR	750		1988	1989	R	
M	VFR 750 F	750		1990	1993	R	
M	VFR 750 F	750		1994	1997	R	
M	VT 750 C SHADOW	750		1997	2009	F	
M	VT 750 AMERICAN CLASSIC EDITION	750		1998	1998	F	
M	VT 750 DC Black Widow	750		2001	2004	F	
M	VT 750 DC Shadow Spirit	750		2007	2009	F	
M	VT 750 C2 SHADOW BLACK SPIRIT	750		2010		F	
M	VT 750 S	750		2010	2012	F	
M	VFR 950 F CARAT	950		1992		R	
M	CB 1000 SUPERFOUR (BIG FOUR)	1000		1992		R	
M	VT 1300 CX	1300		2010		F	
INDIAN	Chief Classic	1811	55	2014	2016	R	
	Chief Vintage	1811	55	2014		R	
	Chief Dark Horse	1811	55	2015		R	
	Chief Vintage	1811	62	2018		R	
	Chieftain	1811	55	2014	2016	R	
	Chieftain	1811	62	2018		R	
	Chieftain Classic	1811	62	2018		R	
	Chieftain Dark Horse	1811	62	2018		R	
	Chieftain Limited	1811	62	2018		R	
	Roadmaster	1811	55	2015	2016	R	
	Roadmaster	1811	62	2018		R	
	Springfield Dark Horse	1811		2018		R	
KYMCO	VENOX 250	250		2000		F	
TRIUMPH	BONNEVILLE 800 / T100	100		2001		F	
	AMERICA 865	865		2007		F	
	AMERICA 865 (12 Spoke Cast wheel)	865		2010		F	
	BONNEVILLE T100 865	865		2005		F	
	BONNEVILLE California Street Racer 865	865		2008		F	
	BONNEVILLE T100 BLACK	865		2012		F	
	BONNEVILLE T100 SE	865		2012		F	
	BONNEVILLE Newchurch	865		2015		F	
	BONNEVILLE Spirit	865		2015		F	
	BONNEVILLE T214	865		2015		F	
	SCRAMBLER 865	865		2006		F	



		CC	KW	FROM	TO	FRONT / REAR	LEFT / RIGHT
M	SPEEDMASTER	865		2010		F	
M	SCRAMBLER 900	900		2010		F	
M	STREET CUP	900		2017		F	
M	STREET SCRAMBLER	900		2017		F	
M	STREET TWIN (DP01)	900	40	2016		F	
M	THRUXTON 900	900		2008		F	
M	THRUXTON 900 ACE	900		2015		F	
M	TIGER XC	1050		2011		F	
M	BONNEVILLE T120 (DU01)	1200	59	2016		F	
M	BONNEVILLE T120 BLACK (DU01)	1200	59	2016		F	
M	BONNEVILLE BOBBER	1200	57	2017		F	
M	BONNEVILLE BOBBER BLACK	1200	57	2017		F	
M	Bonneville Speedmaster	1200	57	2019		F	
M	THRUXTON	1200		2016		F	
VICTORY	Cross Country			2010	2014	R	
	Cross Country Tour			2012	2015	R	
	Cross Country 8-Ball			2015		R	
	Cross Roads			2010	2012	R	
	Cross Roads Classic (Spoke Wheel)			2013	2014	R	
	Cross Roads 8 - Ball (Cast Wheel)			2014		R	
	Cross Touring			2013	2014	R	
	Gunner			2015		R	
	Hammer			2008	2011	R	
	Hammer S			2008	2015	R	
	Hammer 8 Ball			2010	2015	R	
	Hard Ball			2012	2013	R	
	Highball (Cast & Spoke Wheel)			2012		R	
	Jackpot			2010	2014	R	
	Judge			2013		R	
	King Pin			2008	2012	R	
	Kingpin Tour			2008	2009	R	
	Kingpin 8-Ball			2008	2011	R	
	King Pin Low			2009	2009	R	
	Magnum			2015		R	
	Magnum X-1			2015		R	
	Cory Ness Jackpot			2008	2010	R	
	Zach Ness Vegas			2008	2012	R	
	Arlen Ness Victory Vision			2010	2012	R	
	Cory Ness Cross Country			2011	2012	R	
	Broadwalk			2013	2015	R	
	Vegas 8-Ball			2008	2015	R	
	Vegas			2008		R	
	Vegas Low			2008	2009	R	
	Vegas Jackpot			2008	2009	R	
	Vision Street			2008	2009	R	
	Vision Tour (All models)			2008	2015	R	
	Vision 8 Ball			2010	2011	R	

M = MOTORCYCLE
S = SCOOTER
A = ATV
Sn = SNOWMOBILE

FDB665

90.0 x 49.0 x 11.5 mm

MATERIAL AVAILABILITY											
AG	EF	P	PRP	ST	SM	SG	ZR	XRAC	ZRAC	CP1	CPRO
		✓		✓							

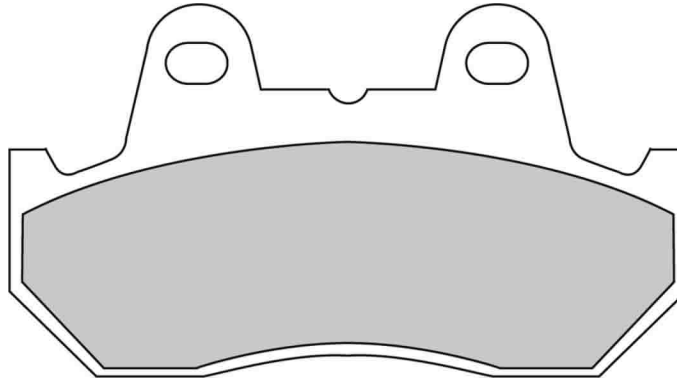

ALSO AVAILABLE		
SHAPE	TH. MM	NOTES
FDB244	10.0	
FDB538	9.0	

CROSS REFERENCE	
BREMBO	07HO10
CL BRAKES	2289
EBC	FA069/3
LUCAS/TRW	MCB512
NEWFREN	FD0084
SBS	542
VESRAH	VD-123
VESRAH	VD-123/3
VESRAH	VD-132

		CC	KW	FROM	TO	FRONT REAR	LEFT RIGHT
	HONDA						
	M NV 400 CUSTOM	400		1988		R	
	M CBR 500	500		1987	1990	R	
	M VF 500 FE - F2E	500		1984		R	
	M VF 500 FF - F2F	500		1984		R	
	M CBR 600 F/R HURRICANE	600		1987	1990	R	
	M CBX 750 FE	750		1983	1984	R	
M VF 750 F-FD-FE-MAGNA-SABRE-INT	750		1982		R		

		CC	KW	FROM	TO	FRONT REAR	LEFT RIGHT
	M VFR 750 F INTERCEPTOR	750		1986	1987	R	
	M VF 1000 BOL D'OR	1000		1984	1986	R	
	M VF 1000 - 2	1000		1984	1986	R	
	M VF 1000 F - FE	1000		1984	1986	R	
	M GL 1520	1500		1988	1989	F	
	M GL 1520 / 6 GOLD WING	1500		1988	1991	R	

FDB666

74.7 x 55.3 x 9.2 mm

October 2020: thickness change from 10.9 to 9.2mm

MATERIAL AVAILABILITY											
AG	EF	P	PRP	ST	SM	SG	ZR	XRAC	ZRAC	CP1	CPRO
		✓		✓							

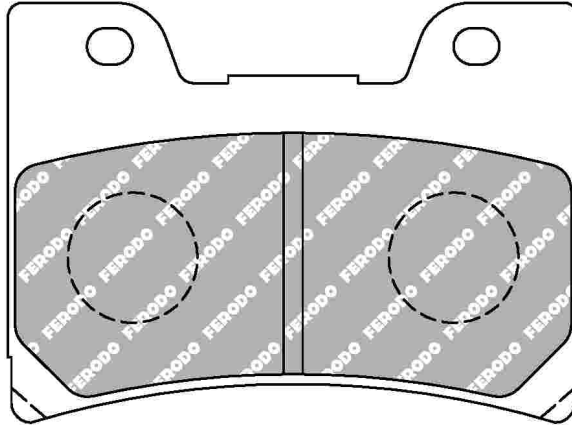

ALSO AVAILABLE		
SHAPE	TH. MM	NOTES
FDB637		6 mm Pin Holes

CROSS REFERENCE	
BRAKING	729
BREMBO	07YA24
BRENTA	4138
CL BRAKES	2311
EBC	FA160
GALFER	FD121
LUCAS/TRW	MCB622
NEWFREN	FD0191
SBS	645
VESRAH	VD-251

		CC	KW	FROM	TO	FRONT REAR	LEFT RIGHT
 YAMAHA	M SRX 400	400		1990	1996	F	
	M FZR 600 R	600		1990		F	
	M TDM 850	850		1996	2001	F	

		CC	KW	FROM	TO	FRONT REAR	LEFT RIGHT
 YAMAHA	M FZR 1000 R - EX-UP	1000		1989	1990	F	
	M YMX 1200 12N V-MAX	1200		1993	2003	F	

FDB672

75.1 x 36.1 x 9.1 mm

February 2019:AG superseded by EF

MATERIAL AVAILABILITY											
AG	EF	P	PRP	ST	SM	SG	ZR	XRAC	ZRAC	CP1	CPRO
	✓										

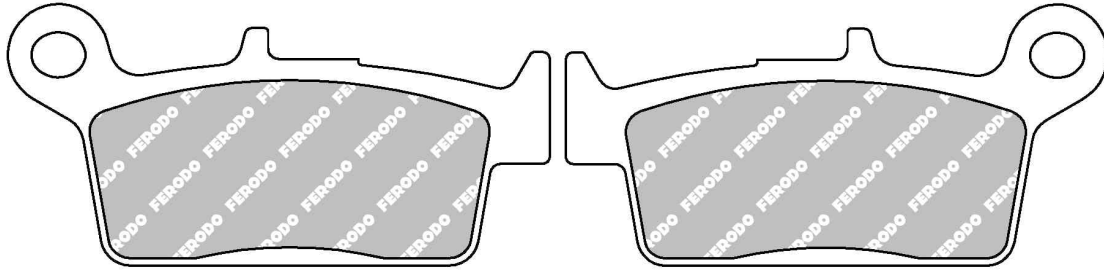

ALSO AVAILABLE		
SHAPE	TH. MM	NOTES
FDB539	9.7	
FDB783	7.6	

CROSS REFERENCE	
BREMBO	07011
BREMBO	7011
BREMBO	7028
CL BRAKES	2314
CL BRAKES	3014
EBC	FA233
EBC	SFA131/3
EBC	SFA233
FRAS-LE	PD/864
GALFER	FD144
GOLD FREN	071
LUCAS/TRW	MCB665
NEWFREN	FD0192
SBS	690
VESRAH	VD-144/2

		CC	KW	FROM	TO	FRONT / REAR	LEFT / RIGHT
	HERCULES (SACHS)	M					
		M	SAMBA SR 80	80	1993		F
	M	SAMBA SR 125	125	1993		F	
HONDA	S	NH 50 LEAD	50	1994		F	
	S	YUPY 90 (NH 90)	90	1990		F	
KYMCO	M	COBRA 50 / RACER & CROSS	50	1999	2006	F	
	M	CURIO 50	50	1994		F	
	M	CX 50 SUPER	50	1994	1997	F	
	M	KB 50	50	1994	2000	F	

		CC	KW	FROM	TO	FRONT / REAR	LEFT / RIGHT
		M	K 12 50	50	1995		F
		M	SCOUT 50	50	1998		F
	M	SNIPER 50 DD	50	1994	1996	F	
	M	TOP BOY 50	50	2000		F	
	M	ZX 50 FEVER	50	1995		F	
	M	ZK 50 SUPERFEVER	50	1999		F	
PEUGEOT	M	SV 50 GEO (all models)	50	1993		F	
	M	SV 125 GEO	125	1993		F	

FDB673

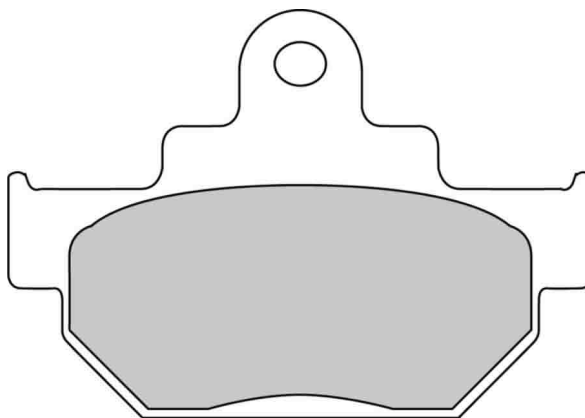

77.0 x 54.0 x 9.4 mm

MATERIAL AVAILABILITY											
AG	EF	P	PRP	ST	SM	SG	ZR	XRAC	ZRAC	CP1	CPRO
		✓									



ALSO AVAILABLE		
SHAPE	TH. MM	NOTES
FDB404	7.1	

CROSS REFERENCE	
BRAKING	681
BREMBO	07SU08
CL BRAKES	2386
EBC	FA106/2
GALFER	FD070
LUCAS/TRW	MCB551
NEWFREN	FD0095
SBS	582
VESRAH	VD-329
VESRAH	VD-329/2

		CC	KW	FROM	TO	FRONT REAR	LEFT RIGHT
	APRILIA						
	M TUAREG 125 RALLY	125		1991		F	
	SUZUKI						
	M DR 250 S	250		1985		F	
	M DR 500 S	500		1989		F	
	M DR 600 S - SU	600		1985	1986	F	
	M DR 600 R DAKAR-DJEBEL	600		1987	1988	F	
	M DR 600 DJEBEL - DAKAR	600		1989		F	

		CC	KW	FROM	TO	FRONT REAR	LEFT RIGHT
	SUZUKI						
	M DR 600 S	600		1989		F	
	M SP 600	600		1985		F	
	M DR 650 RS-R DAKAR	650		1990		F	
	M LS 650 P	650		1993		F	
	M VS 800 S INTRUDER	800		1991	1992	F	

M = MOTORCYCLE
S = SCOOTER
A = ATV
Sn = SNOWMOBILE

FDB677

94.6 x 42.1 x 7.6 mm / 77.1 x 42.1 x 7.6 mm

July 2016: AG superseded by EF

MATERIAL AVAILABILITY											
AG	EF	P	PRP	ST	SM	SG	ZR	XRAC	ZRAC	CP1	CPRO
✗	✓	✓									

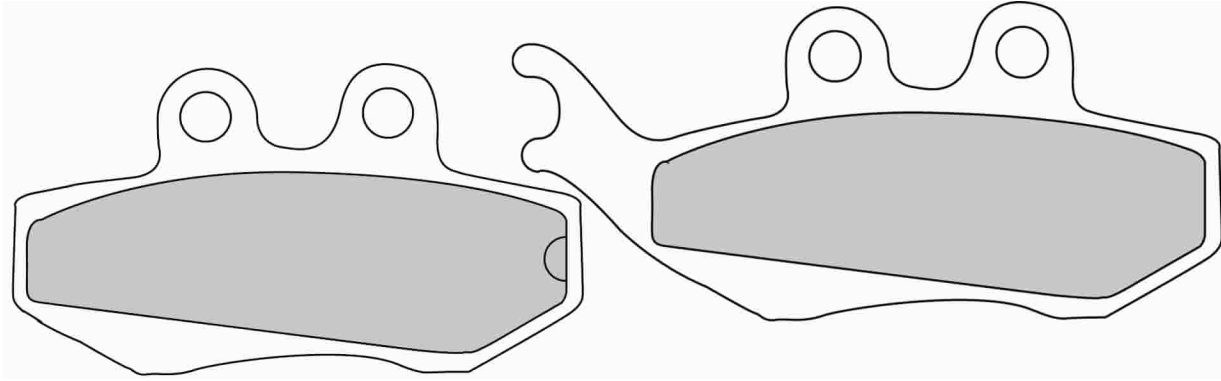

CROSS REFERENCE	
BRAKING	770
BREMBO	07012
BREMBO	7012
BRENTA	3017
BRENTA	4017
CL BRAKES	1146
CL BRAKES	3031
EBC	FA194
GALFER	FD162
LUCAS/TRW	MCB664
LUCAS/TRW	MCB734
NEWFREN	FD0195
NEWFREN	FD0281
SBS	120
SBS	168
SBS	689
SBS	774
VESRAH	VD-9015
VESRAH	VD-967/2

		CC	KW	FROM	TO	FRONT REAR	LEFT RIGHT
	M PR3 125 Enduro	125		2008	2012	F	
	M PR3 125 Enduro Pro	125		2008	2012	F	
	M PR3 125 Supersmoto	125		2008	2012	F	
	M PR3 125 Supersmoto Pro	125		2010	2011	F	
	M PR3 125 Trial	125		2011	2012	F	
	M PR4 Enduro 125	125		2010	2012	F	
	M PR4 Enduro Pro 125	125		2010	2012	F	
	M PR4 Supersmoto 125	125		2010	2012	F	
	M PR4 Supersmoto Pro 125	125		2010	2011	F	
	M PR3 200 Enduro	200		2008	2011	F	
	M PR3 200 Enduro	200		2012	2014	F	
	M PR3 200 Enduro Pro	200		2010	2011	F	
	M PR3 200 Enduro Pro	200		2012	2014	F	
	M PR3 200 M/X	200		2010	2011	F	
	M PR3 200 M/X Pro	200		2010	2011	F	
	M PR3 200 M/X Pro	200		2012	2014	F	
	M PR3 200 Supersmotard Pro	200		2010	2011	F	
	M PR3 200 Supersmoto	200		2008	2011	F	
	M PR3 200 Supersmoto	200		2012	2014	F	
	M PR4 200 Supersmoto Pro	200		2010	2011	F	
M PR4 Enduro 200	200		2010	2011	F		
M PR4 Enduro 200	200		2012	2014	F		
M PR4 Enduro Pro 200	200		2010	2011	F		
M PR4 Enduro Pro 200	200		2012	2014	F		
M PR4 200 Extreme	200		2012	2014	F		
M PR4 200 Supersmoto	200		2010	2011	F		
M PR4 200 Supersmoto	200		2012	2014	F		
APRILIA	M CLASSIC 50	50		1992		F	

		CC	KW	FROM	TO	FRONT REAR	LEFT RIGHT	
	M MX 50	50		2002	2004	F		
	M RS 50	50		1999	2005	F		
	M RX 50	50		1992	1995	F		
	M RX 50 RACING	50		2003	2007	F		
	M SX 50	50		2007	2008	F		
	M SX 50	50		2008	2013	F		
	M TUONO 50	50		2003	2004	F		
	M ETX 125	125		1998		F		
	M PEGASO 125 KAT	125		1994		F		
	M RX 125	125		1992	1994	F		
	S SCARABEO 150 GT	150		2004		F		
	BENELLI	M Velvet 125 (13" Front Wheel/Touring)	125		2008	2012	F	
		M Velvet 150 (13" Front Wheel/Touring)	150		2008	2012	F	
		M VELVET 250	250		1999		F	
	BETA	M RR 50 Enduro	50		2004	2007	F	
	M RR 50 Standard	50		2005	2008	F		
	M RR 50 Enduro	50		2008	2012	F		
	M RR Motard 50 Track (Cast Wheels)	50		2008	2012	F		
	M RR 50 Motard (Spoke Wheel)	50		2009	2012	F		
	M RR 50 Enduro Racing	50		2009	2011	F		
	M RR 50 Motard Skull	50		2011		F		
	M RR 50 Enduro Factory	50		2012		F		
	M ALP 125 4T	125		2005	2012	F		
	M RE 125 4T Enduro	125		2009	2010	F		
	M RR 125 4T Motard (A/C - Spoke Wheel)	125		2008	2012	F		
	M RR 125 4T Enduro (A/C)	125		2009	2011	F		
	M RR 125 4T Enduro (L/C)	125		2011		F		
	M RR 125 4T Motard (L/C - Cast Wheel)	125		2011	2012	F		



		CC	KW	FROM	TO	FRONT / REAR	LEFT / RIGHT
	M Urban 125	125		2008	2012	F	
	M Urban 125 Special	125		2009	2012	F	
	M ALP 200 4T	200		2005	2012	F	
	M URBAN 200	200		2008	2012	F	
	M Urban 200 Special	200		2009	2012	F	
	M ALP 4.0 350	350		2004		F	
	M ALP 4.0 350 4T	350		2005	2012	F	
CPI	M GTS 50 / 125 / 200	125		2002	2003	F	
DERBI	M GP1 50 OPEN	50		2007		F	
	M SENDA DRD RACING R 50	50		2005		F	
	M Cross City 125	125		2007	2008	F	
	M SENDA 125 R 4T	125		2005		F	
	M SENDA BAJA 125 SM	125		2008		F	
GASGAS	M PAMPERA 250	250		2002		F	
GILERA	M DNA 50	50		2001		F	
	M DNA 125	125		2000	2003	F	
	M RUNNER 125	125			1999	F	
	M RUNNER 125 FX - SP	125		2000		F	
	M RUNNER 125 VX 4T	125		2001		F	
	M DNA 180	180		2001	2002	F	
	M RUNNER 180	180			1998	F	
	M RUNNER 180 FXR - SP	180		1999		F	
	M RUNNER 180 VXR 4T	180		2001		F	
	M RUNNER 200 VXR	200		2004		F	
HONDA-HM ITALIA	M CRE 50 (from frame nr.2819)	50				F	
	M CRE 50	50		2006		F	
KEEWAY	M TX50	50		2010	2012	F	
	M X-Ray 50 Supermoto	50		2007	2009	F	
	M TX125	125		2010	2012	F	
	M TX 125 SM (17" F/Wheel)	125		2013		F	
	M TX200 (19" F/Wheel)	200		2013		F	
KSR MOTO BY GENERIC	S Toxic 50	50		2007	2008	F	
	M Trigger 125 SM	125		2008	2009	F	
	M Trigger 125 X	125		2008	2009	F	
MALAGUTI	M XSM 50 SUPERMOTARD	50		2003		F	
	M MADISON 125	125		1999	2003	F	
	M MADISON 3 - 125	125		2006		F	
	M PHANTOM MAX 125	125		2004		F	
	M X3M Motard 125	125		2008		F	
	M MADISON 150	150		1999	2003	F	
	M MADISON 180	180		1999	2003	F	
	M MADISON S 200	200		2004		F	
	M PHANTOM MAX 200	200		2004		F	
	M MADISON 3 250 RS	250		2004		F	
	M PASSWORD 250	250		2005		F	
	M PHANTOM MAX 250	250		2006		F	
PEUGEOT	M ELYSEO 125	125		2003		F	
	S Elystar 125 (5 bolt fixing front disc)	125		2006	2007	F	



		CC	KW	FROM	TO	FRONT / REAR	LEFT / RIGHT
	S Geopolis 125 (AJP Caliper/ABS)	125		2007	2012	F	
	S Geopolis 125 Executive (AJP Caliper/Non ABS)	125		2007	2012	F	
	S Geopolis 125 Urban (AJP Caliper/ ABS)	125		2007	2012	F	
	M SATELIS 125	125		2006		F	
	S Satelis 125 4V Executive/Premium/City	125		2006	2009	F	
	S Satelis 125 Compressor (4T)	125		2006	2011	F	
	S Satelis 125 RS (AJP Caliper)	125		2007	2011	F	
	S Satelis 125 Urban (AJP Caliper/ABS)	125		2007	2011	F	
	S Satelis 125 Blacksat (AJP Calipers)	125		2010	2011	F	
	S Satelis 125 Whitesat (AJP Calipers)	125		2010	2011	F	
	M ELYSEO 150	150		2001		F	
	S Elystar 150 (5 bolt fixing front disc)	150		2006	2007	F	
	S Geopolis 250 Executive (AJP caliper/ Non ABS)	250		2007	2011	F	
	S Geopolis 250 Urban (AJP caliper/ ABS)	250		2007	2011	F	
	S Satelis 250 Urban (AJP Caliper/ABS)	250		2007	2012	F	
	S Geopolis 400 Urban (AJP Caliper/ ABS)	400		2007	2012	F	
PIAGGIO	M Beverly 125 (M28) - Grimeca caliper	125	11	2001	2006	F	
	M Beverly 125 (M28) - Grimeca caliper	125	11	2001	2006	R	
	M HEXAGON 125 LX	125		1998	1999	F	
	M SKIPPER 125 ST 4T	125		1998	1999	F	
	M SKIPPER ST 125 (Grimeca caliper)	125		2000		F	
	M VESPA GRANTURISMO 125 (Grimeca caliper)	125		2003		F	
	M SKIPPER 150 ST 4T	150		1998	1999	F	
	M SKIPPER ST 150 (Grimeca caliper)	150		2000		F	
	M HEXAGON 180 LX	180		1998	1999	F	
	M SUPER HEXAGON 180 GTX	180		2000		F	
	M BEVERLY 200 (Grimeca caliper)	200		2001		F	
	M BEVERLY 200 (Grimeca caliper)	200		2001		R	
	M VESPA GRANTURISMO 200 (Grimeca caliper)	200		2003		F	
	M BEVERLY 250 (Grimeca caliper)	250		2002	2006	F	
	M BEVERLY 250 (Grimeca caliper)	250		2002	2006	R	
	M HEXAGON 250	250		1998	1999	F	
	M SUPER HEXAGON 250 GTX	250		2001	2002	F	
RIEJU	M MRX 50 PRO / TOP	50		2004	2008	F	
	M RS2 NKD	50		2005		F	
	M SMX 50 PRO	50		2004		F	
	M RS2 125 / PRO	125		2009		F	
SACHS	M ZX 125	125		2001		F	
SHERCO	M Enduro 50c (2T)Urban/SU - Spoke wheel models)	50		2008	2013	F	
	M SM 0.5cc Black Panther	50		2008	2010	F	
	M Supermotard 50cc (2T)	50		2008	2013	F	
	M City Corp 125 (All models)	125		2008		F	
	M SE 1.25 F Enduro (4T)	125		2010	2012	F	
	M SM 1.25 i F Black Panther (4T)	125		2010	2012	F	
YAMAHA	M DT 50 R SM	50		2004		F	
	M DT 50 X	50		2008		F	
	M TZR 50 /Race Replica 07	50		2004		F	
	M XT 125 X	125		2008		F	

M = MOTORCYCLE
S = SCOOTER
A = ATV
Sn = SNOWMOBILE

FDB680

39.9 x 49.6 x 7.0 mm

July 2016:AG superseded by EF

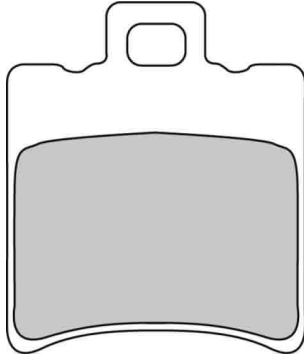

MATERIAL AVAILABILITY											
AG	EF	P	PRP	ST	SM	SG	ZR	XRAC	ZRAC	CP1	CPRO
✗	✓			✓							

CROSS REFERENCE	
BRAKING	761
BREMBO	07003
BREMBO	07BB18
BREMBO	7003
BRENTA	3010
BRENTA	4010
CL BRAKES	2307
CL BRAKES	3013
EBC	SFA193
GALFER	FD153
GOLD FREN	098
LUCAS/TRW	MCB696
NEWFREN	FD0196
SBS	123
SBS	143
SBS	697
SBS	725
SBS	771
VESRAH	VD-948
VESRAH	VD-948/2
VESRAH	VD-980

		CC	KW	FROM	TO	FRONT / RÉAR	LEFT / RIGHT
	APRILIA						
M	AMICO 50 all models	50		1992		F	
M	AREA 51 50	50		1998		F	
M	AREA 51 50	50		1998		R	
M	GULLIVER 50	50		1995	1998	F	
M	HABANA 50 all models	50		1998		F	
M	MOJITO CUSTOM 50	50		1999	2003	F	
M	MOJITO CUSTOM 50	50		2004	2012	F	
M	RALLY 50 air cooled	50		1995	2002	F	
M	RALLY 50 liquid cooled	50		1996	2000	F	
M	RALLY 50 liquid cooled	50		1996	2000	R	
S	SCARABEO 50 / 50 Street 4T-2T	50		1996		F	
S	SCARABEO 50 DELUXE	50		1998		F	
S	SCARABEO 50 DELUXE	50		1998		R	
S	SONIC 50 SPICE	50		1997		F	
S	SONIC 50 GP	50		1997		F	
S	SR 50 WWW - NETSCAPER	50		1997	2001	F	
S	SR 50 WWW - NETSCAPER	50		1997	2001	R	
S	SR 50 STEALTH - RACING	50		1997	1999	F	
S	SR 50 STEALTH - RACING	50		1997	1999	R	
S	SR 50 2000	50		2000		F	
S	SR STREET 50	50		2003		F	
S	SR 50 FACTORY	50		2004		F	
M	LEONARDO 125	125		1995	1996	R	
M	LEONARDO 125	125		1997	1998	R	
M	MOJITO CUSTOM 125	125		2004		F	
M	LEONARDO	150		1997	1998	R	

		CC	KW	FROM	TO	FRONT / RÉAR	LEFT / RIGHT
	ATALA						
M	RS 250	250		1997	1998	R	
M	BYTE 50	50		1996		F	
M	CAROSSELLO 50	50		1997		F	
M	HACKER 50	50			1995	F	
M	HACKER 50	50		1996		F	
M	SHEGGIA 50	50		1998		F	
BENELLI	M 491 50 GT	50		1997		F	
M	K2 50 all models	50		1998	2001	F	
M	NAKED 50	50		1998		F	
M	PEPE 50/50 LX/Classic (7 Spoke Cast Wheel)	50		1999	2013	F	
S	Pepe 50 (5 Spoke Cast Wheel/2T/4T)	50		2010	2012	F	
M	491 50 SPORT - RACING	50		1997		F	
M	491 50 SPORT - RACING	50		1997		R	
M	K2 100 BIPOSTO	100		1999		F	
M	666 125	125		1998		R	
M	ADIVA 125	125		1999		F	
M	VELVET 125	125		1999	2008	F	
M	VELVET 125	125		1999	2008	R	
M	ADIVA 150	150		1999		F	
M	VELVET 150	150		1999	2008	F	
M	VELVET 150	150		1999	2008	R	
BETA	S ARK 50 all models	50		1996		F	
S	ARK 50 all models	50		1996		R	
M	CH 50	50		1996		F	
M	CHRONO 50 13	50		1994		F	
M	CHRONO 50 502	50		1997		F	



		CC	KW	FROM	TO	FRONT / REAR	LEFT / RIGHT	
	M QUADRA 50	50		1995		F		
CAGIVA	M NUVOLA 50	50		2000		F		
	M NUVOLA 125	125		2000		F		
DERBI	M RUNNER 50 2T Blacksoul	50		2011		R		
GILERA	S EASY MOVING 50	50		1995	1996	F		
	M ICE 50	50		2001	2003	F		
	M NRG 50	50		1995	2003	F		
	M RUNNER 50	50		1997	1998	F		
	S RUNNER 50 SP / SKP	50		1999	2005	F		
	M STALKER 50	50		1997		F		
	M STORM 50	50		1994	1995	F		
	M TYPHOON 50	50		1993	1995	F		
	M TYPHOON 50	50		1996		F		
	M TYPHOON 80	80		1995		F		
	M TYPHOON 125	125		1995		F		
	M TYPHOON 125 XR KAT	125		2000		F		
	HERCULES (SACHS)	M GIPSY 50	50		1993		F	
HONDA	S SFX 50	50		1995		F		
	M SH 50 SCOOPY / FIFTY	50		1997	2003	F		
	M SKY 50	50		1997		F		
	M SKY 50 VETRO	50		2000		F		
	S SXR 50	50		1997	1999	F		
	M X8R 50 X	50		1998		F		
	M X8R 50 S	50		1998		F		
	M SH 100 Scoopy	100		1996	2001	F		
	HYOSUNG	M GRAND PRIX 125	125		1998		F	
		M HYPER 125	125		1999		F	
M GRAND PRIX 150		150		1998		F		
ITALJET	M FORMULA 50	50		1994	1996	R		
	M FORMULA 80	80		1994		R		
	M FORMULA 125	125		1994	1996	R		
KEEWAY	S Goccia 50 (2T/4T)	50		2008		F		
KSR MOTO BY GENERIC	S Onyx 50 (2T/All Models)	50		2010	2012	F		
KTM	M KROSS 50	50		1996		F		
MACAL	M 50 FLASH	50		1999		F		
MALAGUTI	M CIAK 50 / CIAK Master 4T 50	50		1999		F		
	M F 10 50 JETLINE /F10 WAP JETLINE	50		1994		F		
	M F 12 50 PHANTOM Twin disk	50		1998		F		
	M F 12 50 PHANTOM Twin disk	50		1998		R		
	M F 15 50 FIREFOX Twin disk	50		1998		R		
	M F 12 50 PHANTOM (liquid cooled)	50		1999		R		
	M F12 R 50 PHANTOM (all liquid cooled models)	50		2007	2011	F		
	M F12 R 50 PHANTOM (all liquid cooled models)	50		2007	2011	R		
	M F12 R 50 PHANTOM (all air cooled models)	50		2007	2011	F		
	M YESTERDAY 50	50		1998		F		
	M CIAK 100	100		1999	2003	F		
	M CIAK 100	100		1999	2003	R		
	M F 12 100 PHANTOM	100		1999	2003	F		
	M F 12 100 PHANTOM	100		1999	2003	R		
	M F 18 WARRIOR 125	125		2001	2003	F		
	M F 18 WARRIOR 125	125		2001	2003	R		
	M F 18 WARRIOR 150	150		2001	2003	F		
	M F 18 WARRIOR 150	150		2001	2003	R		
	MBK	M FLIPPER 50	50		1998		F	
		M STUNT 50	50		2000		F	
M NITRO 100		100		2000	2003	F		
M OVETTO 100		100		2000	2002	F		



		CC	KW	FROM	TO	FRONT / REAR	LEFT / RIGHT
PEUGEOT	M BUXI 50	50		1994	1997	F	
	S Ludix Pro (4T / 14" Wheels/J.Juan Caliper)	50		2011		F	
	M SPEEDAKE 50	50		1995	2001	F	
PGO	S Rodo Show 50	50		2000	2009	F	
PIAGGIO	M FREE 50	50		2002		F	
	M Liberty Sport 50 4T	50		2007	2008	F	
	M Liberty Sport 50 4T	50		2007	2008	R	
	M NRG 50	50		1994	1995	F	
	M NRG 50	50		1996	1997	F	
	M NRG 50 MC2	50		1996	1997	F	
	M NRG 50 MC2 DD	50		1998		F	
	M NRG 50 MC2	50		1998		F	
	M NRG 50 EXTREME (Rear disc model)	50		1999	2001	F	
	M NRG 50 EXTREME (Rear drum model)	50		1999	2001	F	
	M NRG 50 DT MC3 (Rear drum model)	50		2001	2005	F	
	M NRG 50 MC3 DD (Rear disc model)	50		2001	2005	F	
	M NTT 50	50			1995	F	
	M NTT 50	50		1996		F	
	M TPH 50 X-R	50		2005		F	
	M TYPHOON 50	50		1993	1999	F	
	M TYPHOON XR 50	50		2000	2007	F	
M XR 50	50		2000		F		
M ZIP 50 FAST RIDER	50		1993	1997	F		
M ZIP 50 BASE (Disc)	50		1995	1996	F		
M ZIP 50 Electric	50		2002		F		
M TYPHOON 80	80		1993	1996	F		
M FREE 100	100		2002		F		
M HEXAGON 125	125		1994	1997	F		
M TYPHOON 125 / XR 125	125		1995	2000	F		
M TYPHOON 125 / XR 125	125		1999	2003	F		
M HEXAGON 150	150		1994	1999	F		
QUADRO	S 350 D	350		2011	2015	F	
	S 350 S	350		2013	2015	F	
	S 350 4	350		2014	2015	F	
RIZZATO	M ATALA HACKER 50	50		1995		F	
SUZUKI	M AY 50 KATANA (Brembo caliper)	50		1997		F	
YAMAHA	M 50 BREEZE	50		1994	1996	F	
	S BW'S / ZUMA II 50	50		1995		F	
	S BW's NAKED 50	50		2003	2004	F	
	S BW'S 50	50		2004	2004	F	
	S BW's 50	50		2005		F	
	S BW's NAKED 50	50		2009		F	
	S CS 50 Jog R	50		2002	2005	F	
	S CS 50 Z (Jog RR)	50		2003	2005	F	
	S CS 50 Z (Jog RR)	50		2006	2012	F	
	S CS 50 Jog R	50		2006		F	
	S NS 50 F (1GB) AEROX 4 (4T)	50		2013		F	
	S NS 50 AEROX R	50		2013		F	
	S NS 50 AEROX R NAKED	50		2013		F	
	M 50 SPY	50		1996	1998	F	
	S YN 50 R NEO'S	50		1997	2002	F	
S YN 50 NEO'S	50		2002	2006	F		
S YN 50 NEO'S 2T	50		2007		F		
S YN 50 NEO'S 4T	50		2009		F		
M 50 ZUMA	50		1996		F		
M MAXTER 150	150		2001	2003	F		

M = MOTORCYCLE
S = SCOOTER
A = ATV
Sn = SNOWMOBILE

FDB694

35.3 x 51.7 x 6.1 mm

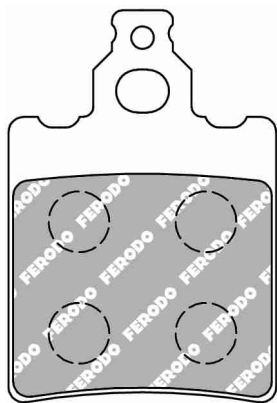

MATERIAL AVAILABILITY											
AG	EF	P	PRP	ST	SM	SG	ZR	XRAC	ZRAC	CP1	CPRO
✓				✓		✗					

ALSO AVAILABLE

SHAPE	TH. MM	NOTES
FDB624	7.1	

Pinze / Calipers

Grimeca

2-Piston, Castle Top: small

CROSS REFERENCE

BRAKING	648
BREMBO	07BB13
CL BRAKES	3037
COBREQ	N-914
EBC	FA060
EBC	FA337
FRAS-LE	PD/857
GALFER	FD048
LUCAS/TRW	MCB552
NEWFREN	FD0048
SBS	574
VESRAH	VD-920

		CC	KW	FROM	TO	FRONT / REAR	LEFT / RIGHT
	APRILIA						
	M AF1 50 AE all models	50		1987		R	
	M AF1 50 FUTURA	50		1990		R	
	M AF1 50 EUROPA	50		1991		R	
	M ET 50 AE	50	4	1987		R	
	M ET 50	50	3	1988		R	
	M MX 50	50		2002	2004	R	
	M RS 50	50		1993	1998	R	
	M RS 50	50		1999	2005	R	
	M RX 50	50		1989	1991	R	
	M RX 50 RACING	50		2003	2007	R	
	M SX 50	50		2007	2008	R	
	M TUAREG 50 RALLY	50		1990		R	
	M CLIMBER 240	240		1989	1990	R	
	M CLIMBER 275	275		1989	1992	R	
BETA	M R 150 (Minicross /4T/49cc)	50		2010	2012	R	
	M ALP 4.0 350	350		2004		R	
CAGIVA	M M4 Supermotard	350		2004	2006	R	
	M BLUES 50	50		1989		R	
	M COCIS 50	50		1988		R	
	M LUCKY EXPLORER 50	50		1988		R	
	M W4 PRO ACTION 50	50		1994		R	
	M COCIS 80	80		1989		R	
	M W4 PRO ACTION 80	80		1994		R	
	M ALETTA 125 ELECTRA	125			1984	F	
	M ALETTA 125 ELECTRA	125		1984		F	
	M ALETTA 125 ORO S2	125		1986		F	
	M ALETTA 125 ORO S2	125		1986		R	
	M ALETTA 125 ELECTRA CLASSIC	125		1987		F	
	M ALETTA 125 ELECTRA CLASSIC	125		1987		R	
	M ALETTA 125 ELECTRA	125		1988		F	
	M BLUES 125	125		1993		R	
M CRUISER 125	125		1987		R		
M DAKAR 125	125		1985		F		
M ELEFANT 125	125			1984	F		
M ELEFANT 125	125		1984		F		
M ELEFANT 125	125		1985	1986	F		
M GP 125 S ALETTA ORO	125		1985		F		

		CC	KW	FROM	TO	FRONT / REAR	LEFT / RIGHT
	DERBI						
	M GP 125 S ALETTA ORO	125		1985		R	
	M N 125	125		1991		R	
	M SST 125 spoke wheel	125				F	
	M SST 125	125		1981		F	
	M SST 125 LOW RIDER	125		1983		F	
	M SXT 125	125		1982		F	
	M TAMANACO 125	125		1989		R	
	M W8 125 PRO ACTION	125		1996		R	
	M WSXT 125 ALETTA ROSSA	125		1983		F	
	M XSST 125	125			1980	F	
	M XSST 125	125		1981		F	
	M ELEFANT 200	200		1985		F	
	M ELEFANT 200 A.E.	200		1986		F	
	M ELEFANT 200	200		1988		F	
FANTIC	M GPR 75 SPORT	75		1990		R	
	M CABALLERO 50 RC	50		1990		R	
	M KOALA 50	50		1987		F	
	M KOALA 50	50		1987		R	
	M RAIDER 125	125		1983		F	
	M RAIDER 125 LC	125		1983		F	
GARELLI	M GTA 125	125		1986	2000	F	
	M GTA 125	125		1986	2000	R	
	M GTA 125	125		1986	1986	F	
GILERA	M NGR 250	250		1985		F	
	HRD	M FORMULA 125 LS	125		1986		F
M FORMULA 125 LS		125		1986		R	
M PLATINO 125 SL		125		1986		F	
	M PLATINO 125 SL	125		1986		R	
	M SILVER 125 HOUSE	125		1986		F	
	M SILVER 125 HOUSE	125		1986		R	
KEEWAY	M X-Ray 50 Supermoto	50		2007	2009	R	
	M TX125	125		2010	2012	R	
KTM	M SX 60 / 65	60		2000	2001	R	
	M SX 65	65		2002	2003	R	
LAVERDA	M 125 (Brembo caliper)	125		1982		F	
	M GS 125 LESMO	125		1990		F	
M GS 125 LESMO	125		1990		R		

		CC	KW	FROM	TO	FRONT / REAR	LEFT / RIGHT
	M	LB 125 UNO	125			F	
	M	LB 125 STRADA	125			F	
	M	LB 125 CUSTOM	125			F	
MALANCA	M	MARK 125	125	1985		F	
	M	OB ONE 125 6M	125	1985		F	

		CC	KW	FROM	TO	FRONT / REAR	LEFT / RIGHT
	M	OB ONE 125 6M	125	1985		R	
	M	OB ONE 125 RACING	125	1985		F	
	M	OB ONE 125 RACING	125	1985		R	
PUCH	M	CROSS 250	250	1986	1986	R	

FDB696

43.6 x 64.6 x 7.0 mm

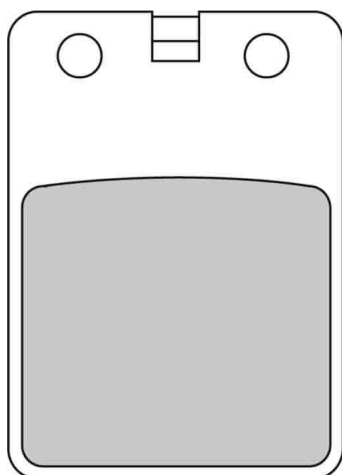

MATERIAL AVAILABILITY											
AG	EF	P	PRP	ST	SM	SG	ZR	XRAC	ZRAC	CP1	CPRO
✓											

Pinze / Calipers

Grimeca

2-Piston, Twin Pin: 1025-2

CROSS REFERENCE

BREMBO	07GR10
EBC	FA098
LUCAS/TRW	MCB576
NEWFREN	FD0069
SBS	605
VESRAH	VD-930

		CC	KW	FROM	TO	FRONT / REAR	LEFT / RIGHT
FANTIC	M	SPORT 125	125		1984	F	
	M	SPORT 125 MK II	125		1984	F	
	M	SPORT 125 MK II (f.a.tel.1706338)	125	1985		F	
	M	STRADA 125 (FM. 4000-A)	125	1983		F	
GARELLI	S	TSR 125	125			F	

		CC	KW	FROM	TO	FRONT / REAR	LEFT / RIGHT
GILERA	M	RV 125	125	1983		F	
	M	RV 200	200	1985		F	
MOTO MORINI	M	K2 350	350	1984		F	
PUCH	M	MAXI 80	80	1988		F	

FDB697

32.0 x 57.0 x 5.5 mm

July 2019: AG superseded by EF

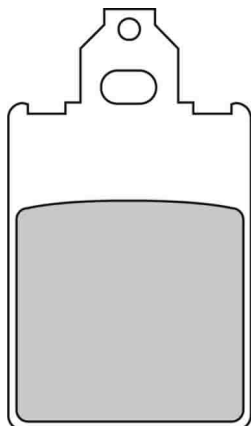

MATERIAL AVAILABILITY											
AG	EF	P	PRP	ST	SM	SG	ZR	XRAC	ZRAC	CP1	CPRO
	✓										

Pinze / Calipers

Grimeca

2-Piston, Castle Top: small

CROSS REFERENCE

BRAKING	694
BREMBO	07009
BREMBO	7009
BRENTA	3012
BRENTA	4012
CL BRAKES	3004
EBC	FA116
GALFER	FD084
GOLD FREN	115
LUCAS/TRW	MCB578
NEWFREN	FD0098
SBS	607
VESRAH	VD-937

		CC	KW	FROM	TO	FRONT REAR	LEFT RIGHT
	ACCOSSATO	M CE 50	50	1987		R	
		M 50 ENDURO CODICE	50	1989		R	
		M KR 80	80	1987		R	
	APRILIA	M AF1 50 AE all models	50	1987		F	
		M AF1 50 FUTURA	50	1990		F	
		M AF1 50 EUROPA	50	1991		F	
		M ET 50 AE	50	4 1987		F	
		M ET 50	50	3 1988		F	
		M ETX 50	50	1986		F	
		M RED ROSE 50	50	1988	1991	F	
		M RED ROSE 50	50	1992		F	
		M RX 50	50	1989	1991	F	
		M TUAREG 50	50	1984	1986	F	
		M TUAREG 50	50	1987		F	
		M TUAREG 50 RALLY	50	1990		F	
		M CLASSIC 80	80	1993		F	
		M CLIMBER 240	240	1989	1990	F	
		M TRX 240 M	240	1989		F	
		M TRX 240 M	240	1989		R	
		M CLIMBER 275	275	1989	1992	F	
	ATK (USA)	M all models 1989-93		1989	1993	R	
	BETA	M ALP 50	50	1991		R	
		M CHRONO 50	50	1992	1994	F	
		M CHRONO 50	50	1994		F	
		M KR 50 ADVENTURE	50	1987		F	
		M KR 50	50	1987		F	
		M TEMPO 50	50	1993		F	
		M TR 34 125	125	1988		R	
		M TR 34 250	250	1986	1988	R	

		CC	KW	FROM	TO	FRONT REAR	LEFT RIGHT
	M TR 34 250 PROFESSIONAL	250		1989		R	
	M TR 34 260	260		1987	1988	R	
	DERBI	M GPR 75 SPORT	75	1990		F	
	FANTIC	M FAST 50	50	1988		F	
		M OASIS 50 .1 RALLY	50	1986		F	
		M OASIS 50 .1	50	1986		F	
		M OASIS 50 .1 E.S.	50	1987		F	
		M OASIS 50 .1 KICK	50	1987		F	
		M OASIS 50 .1 K.S.	50	1987		F	
	GARELLI	M SAHEL 50	50	1991		F	
		M TIGER 50 XLE	50	1986		F	
		M SAHEL 80	80	1989		F	
	GILERA	M EAGLET 50	50	1996		F	
	KTM	M GO 50 SCOOTER	50	1994		F	
	MALAGUTI	M CENTRO 50 SL	50	1993	1999	F	
		M F 12 50 PHANTOM (liquid cooled)	50	1994		F	
		M F 15 50 FIREFOX Twin disk	50	1998		F	
		M F 12 50 PHANTOM (liquid cooled)	50	1999		F	
		M MDX GOLD 50 ENDURO	50	1987		F	
		M MLX 50 ENDURO	50	1987		F	
	MBK	M X-LIMIT 50	50	1998	2003	F	
	PIAGGIO	M FREE 50	50	1996	2000	F	
		M FREE Delivery 50	50	2000	2001	F	
	RIZZATO	M ATALA CAROSELLO 50	50	1997		F	
	TOMOS	M REVIVAL	50	2003		F	
		M STREEMATE	50	2003		F	
	YAMAHA	M DT 50 R	50	1997		F	
		M DT 50 R	50	2002	2007	F	

FDB698

44.1 x 71.6 x 7.6 mm

MATERIAL AVAILABILITY											
AG	EF	P	PRP	ST	SM	SG	ZR	XRAC	ZRAC	CP1	CPRO
		✓									

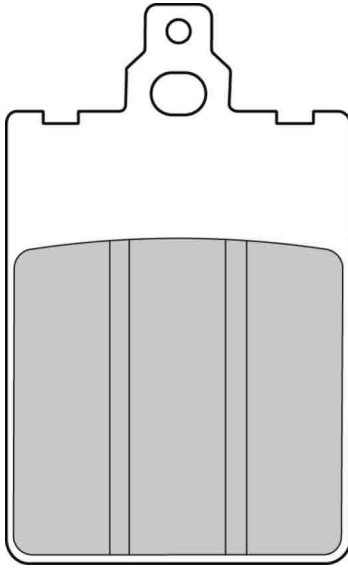

Pinze / Calipers

Grimeca

2-Piston, Castle Top: 1025-1

CROSS REFERENCE	
NEWFREN	FD0099
VESRAH	VD-921

FDB706

77.1 x 42.1 x 7.6 mm

MATERIAL AVAILABILITY											
AG	EF	P	PRP	ST	SM	SG	ZR	XRAC	ZRAC	CP1	CPRO
		✓									

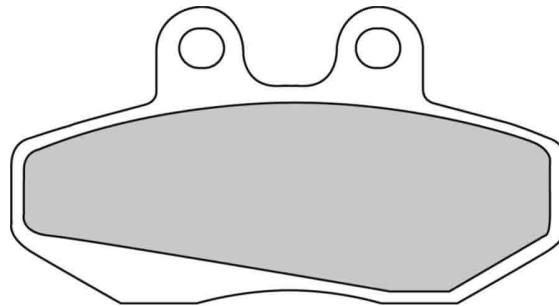

CROSS REFERENCE	
BRAKING	741
BREMBO	07GR14
BRENTA	3055
BRENTA	4055
CL BRAKES	1144
EBC	FA167
FRAS-LE	PD/866
GALFER	FD133
LUCAS/TRW	MCB629
NEWFREN	FD0162
SBS	652
VESRAH	VD-9007

		CC	KW	FROM	TO	FRONT / REAR	LEFT / RIGHT
	AJP	M	PR4 Enduro 125	125	2004	2009	F
		M	PR4 Supermoto 125	125	2004	2009	F
		M	PR4 Enduro 200	200	2004	2009	F
		M	PR4 200 Supermoto	200	2004	2009	F
APRILIA	M	RX 50	50	2003	2014	F	
	M	RX 50 Enduro	50	1995	2003	F	
	M	CLASSIC 125	125	1996		F	
	M	PEGASO 125	125	1989		F	
	M	RED ROSE 125	125	1990		F	
	M	RX 125	125	1990	1991	F	
	M	TUAREG 125 RALLY	125	1989	1990	F	
BETA	M	RR 50 PRO RACE	50	1998		F	
	M	RR 50 all models	50	1999		F	
BULTACO	M	LOBITO 50	50	1998		F	
	M	LOBITO 75	75	1999		F	
CAGIVA	M	ELEFANT 750 BIFARO	750	1990		R	

		CC	KW	FROM	TO	FRONT / REAR	LEFT / RIGHT
	DERBI	M	GPR 50 R/REPLICA	50	1997	2005	F
	HUSQVARNA	M	WXE 125	125	2007		F
PEUGEOT	M	XR 6 50	50	2002		F	
	S	XP 125 Street Evo 2	125	2005		F	
RIEJU	M	XPS 6 SUPERMOTARD	600	2003		F	
	M	MRX 50 CASTROL	50	2001	2002	F	
	M	RR 50 CASTROL	50	2000	2002	F	
	M	RS1 50	50	2001	2004	F	
	M	SPIKE 50 MOTARD	50	2004		F	
	M	MRX 125	125	2002	2008	F	
SACHS	M	SMX 125	125	2002	2003	F	
	M	ROADSTER 125	125	2000	2007	F	
SHERCO	M	Enduro 50cc (2T)	50	2002	2007	F	
	M	Supermotard 50cc (2T)	50	2002	2007	F	
	M	City Corp 125 (All models)	125	2003	2007	F	

FDB731

85.2 x 43.0 x 6.2 mm / 56.0 x 37.3 x 8.5 mm

MATERIAL AVAILABILITY

AG	EF	P	PRP	ST	SM	SG	ZR	XRAC	ZRAC	CP1	CPRO
		✓									

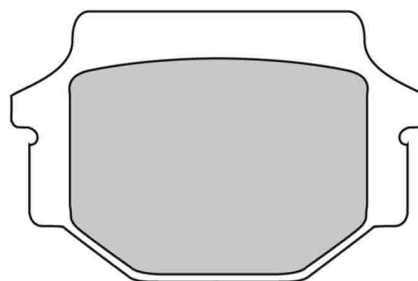
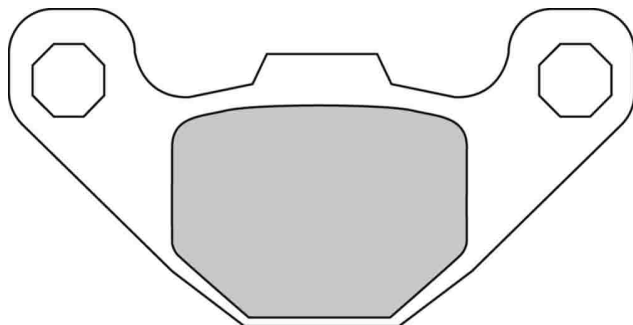

CROSS REFERENCE

CL BRAKES	2466
EBC	FA067/2
LUCAS/TRW	MCB517
NEWFREN	FD0071
SBS	541

		CC	KW	FROM	TO	FRONT / REAR	LEFT / RIGHT
	APRILIA	S	SCARABEO 50 2T Street / 4T 4V	50	2010		F
	DERBI	M	SENDA DRD X-Treme 50 SM	50	2011		F
	M	SENDA DRD X-Treme 50 SM	50	2011		R	
	M	SENDA DRD Racing 50	50	2011		R	
	M	SENDA DRD X-Treme 50 SM Limited	50	2013		F	
	M	SENDA DRD X-Treme 50 SM Limited	50	2013		R	
	M	SENDA Racing 50 SM	50	2018		R	
	M	SENDA X-Treme 50 R	50	2018		F	

		CC	KW	FROM	TO	FRONT / REAR	LEFT / RIGHT
	FANTIC	M	SENDA X-Treme 50 R	50	2018		R
		M	RAIDER 50	50	1981		F
	M	RAIDER 50 .1	50	1986		F	
	M	STRADA 50 (FM. 240)	50	1982		F	
KRAM IT	M	ER 125 RV 3	125	1988		R	
	M	ER 250 RV 3	250			R	
	M	ER 300 RV 3	300	1988		R	
MALAGUTI	M	MEX 50 ENDURO	50	1986		F	

FDB736

57.8 x 53.4 x 9.0 mm

MATERIAL AVAILABILITY											
AG	EF	P	PRP	ST	SM	SG	ZR	XRAC	ZRAC	CP1	CPRO
		✓		✓							

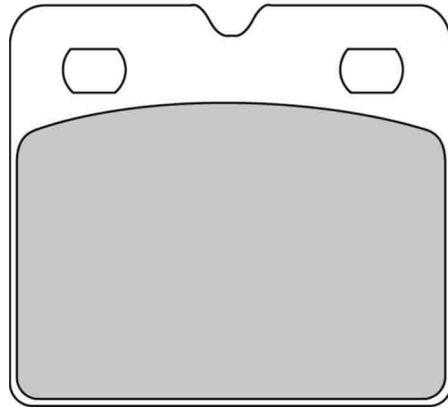

CROSS REFERENCE	
BREMBO	07BB21
CL BRAKES	2258
EBC	FA171
GALFER	FD137
LUCAS/TRW	MCB617
NEWFREN	FD0169
SBS	640
VESRAH	VD-934

		CC	KW	FROM	TO	FRONT REAR	LEFT RIGHT
	BMW						
M	K 75 750	750		1990	1996	F	
M	K 75 750 (ABS caliper)	750		1991	1996	F	
M	K 75 750 RT	750		1991	1993	F	
M	K 75 750 RT	750		1994	2000	F	
M	R 80 800 all models	800		1989	1995	F	
M	R 80 800 R ROADSTER	800		1993	1994	R	
M	K 100 1000 LT	1000		1988	1992	F	
M	K 100 1000 RS	1000		1988	1989	F	

		CC	KW	FROM	TO	FRONT REAR	LEFT RIGHT
							
M	R 100 1000 R ROADSTER - MYSTIC	1000		1993	1996	F	
M	K 1100 LT (ABS)	1100		1992	1997	R	
M	K 1100 RS (ABS and NOT)	1100		1994	1999	R	
M	K 1100 RT (ABS)	1100		1994	1999	R	
M	K 1200 ST	1200		1999	2001	R	
QUADZILLA	A RL 500 Buggie	500		2008	2009	F	
	A RL 500 Buggie	500		2008	2009	R	

M = MOTORCYCLE
S = SCOOTER
A = ATV
Sn = SNOWMOBILE

FDB737

104.1 x 46.0 x 10.0 mm / 88.1 x 46.0 x 10.0 mm

MATERIAL AVAILABILITY											
AG	EF	P	PRP	ST	SM	SG	ZR	XRAC	ZRAC	CP1	CPRO
		✓									

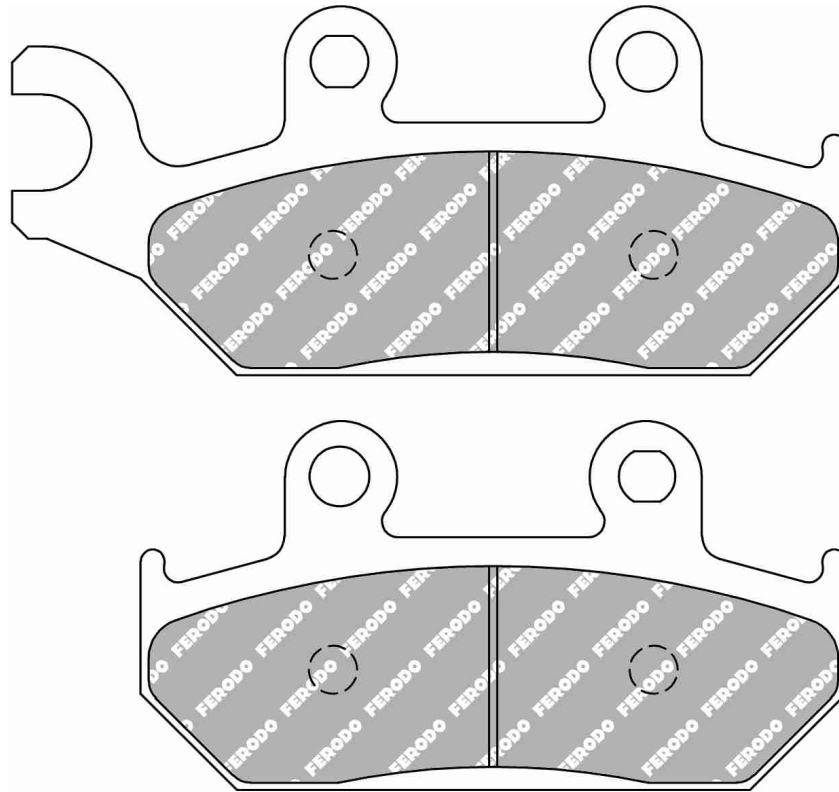

ALSO AVAILABLE		
SHAPE	TH. MM	NOTES
FDB2302	8.25	

CROSS REFERENCE	
BRAKING	737
BREMBO	07YA25
BRENTA	3148
BRENTA	4148
CL BRAKES	2360
EBC	FA172
GALFER	FD129
LUCAS/TRW	MCB627
NEWFREN	FD0167
SBS	650
VESRAH	VD-252

		CC	KW	FROM	TO	FRONT / REAR	LEFT / RIGHT
 YAMAHA	M 400 ARTESIA	400		1991		F	
	M XT 600 E - K	600		1991	1994	F	
	M XT 600 E - K	600		1995	2003	F	

		CC	KW	FROM	TO	FRONT / REAR	LEFT / RIGHT
 YAMAHA	M XT 600 Z TENERE	600		1991		F	
	M XTZ 660 TENERE	660		1991	1998	F	

FDB741

59.0 x 43.0 x 8.0 mm

MATERIAL AVAILABILITY											
AG	EF	P	PRP	ST	SM	SG	ZR	XRAC	ZRAC	CP1	CPRO
		✓									

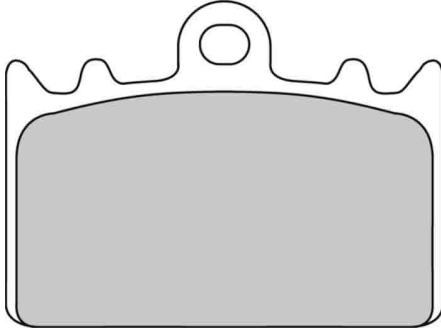

CROSS REFERENCE	
BREMBO	07KA14
CL BRAKES	2363
EBC	FA180
GALFER	FD141
LUCAS/TRW	MCB643
NEWFREN	FD0185
SBS	666
VESRAH	VD-433

		CC	KW	FROM	TO	FRONT REAR	LEFT RIGHT
	KAWASAKI						
M	ZX 400 L	400		1992		F	

		CC	KW	FROM	TO	FRONT REAR	LEFT RIGHT
							
M	ZXR 400 (ZX400-L)	400		1992		F	

M = MOTORCYCLE
S = SCOOTER
A = ATV
Sn = SNOWMOBILE

FDB754

86.1 x 40.2 x 9.3 mm

MATERIAL AVAILABILITY											
AG	EF	P	PRP	ST	SM	SG	ZR	XRAC	ZRAC	CP1	CPRO
	✓	✓		✓							

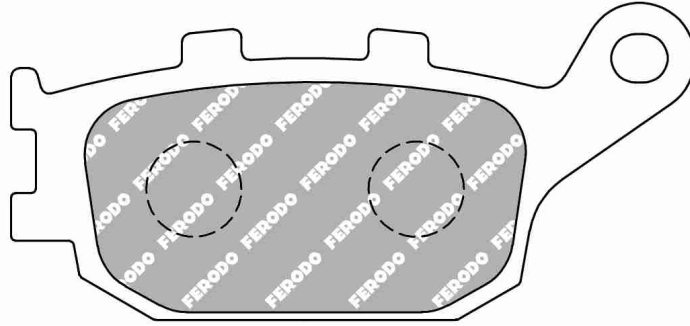
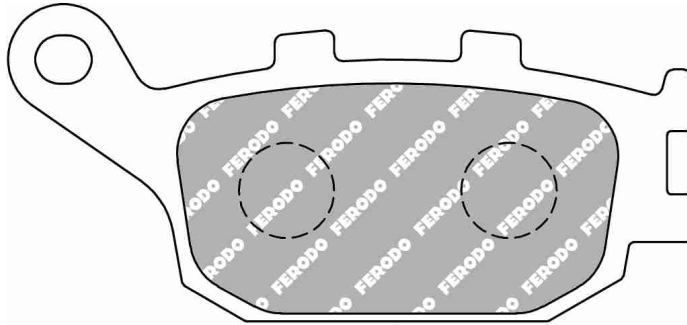

CROSS REFERENCE	
BRAKING	742
BREMBO	07HO36
BRENTA	3072
BRENTA	4072
CL BRAKES	2296
EBC	FA174
GALFER	FD134
GOLD FREN	021
LUCAS/TRW	MCB634
NEWFREN	FD0172
SBS	158
SBS	657
SBS	753
VESRAH	VD-163

HONDA	S	N	SS 250 FORZA (MF04/06)	CC	KW	FROM TO		FRONT	LEFT
						REAR	RIGHT		
	M		CBF 500	500		2004		R	
	M		CBF 500 ABS	500		2004	2007	R	
	M		CB 600 F HORNET (Japan)	600		1998		R	
	M		CB 600 F HORNET (16 wheel)	600		1998	1999	R	
	M		CB 600 F HORNET S (17 wheel)	600		2000	2004	R	
	M		CB 600 F HORNET (17 wheel)	600		2000	2006	R	
	M		CB 600 F HORNET ABS	600		2007		R	
	M		CBF 600 4/A4/Travel	600		2004		R	
	M		CBF 600 N / S / ABS	600		2008		R	
	M		CBF 600 S/ABS	600		2011		R	
	M		CBR 600 F2	600		1991	1994	R	
	M		CBR 600 F3	600		1995	1998	R	
	M		CBR 600 F4 / F4i Sport	600		1999	2004	R	
	M		CBR 600 FX / FY	600		1999	2000	R	
	M		CBR 600 F (Japan)	600		1999	2004	R	
	M		CBR 600 F1 / F2 / FS1 / FS2 Sport	600		2001	2002	R	
	M		CBR 600 F	600		2007		R	
	M		CBR 600 RR	600		2003	2004	R	
	M		CBR 600 RR	600		2005	2006	R	
	M		CBR 600 RR (Racing spec.)	600		2005	2005	R	
	M		FMX 650	650		2005	2006	R	
	M		XL 700 V TRANSALP (ABS)	680	44	2007		R	
	M		NC 700 D Integra (RC62)	700	35	2012	2013	R	

	M	NC 700 D Integra (RC62)	CC	KW	FROM TO		FRONT	LEFT
					REAR	RIGHT		
	M	NC 700 SA, XA (man.gearbox - ABS)	700	38	2012	2013	R	
	M	NC 700 SD, XD (automatic gearbox - ABS)	700		2012		R	
	M	CB 750 N SEVEN FIFTY	750		1992	2002	R	
	M	CB 900 HORNET	900		2002		R	
	M	CBR 900 RR-FIREBLADE (SC28)	900		1992	1995	R	
	M	CBR 900 RR-FIREBLADE (SC33)	900		1998	1999	R	
	M	CBR 900 RR-FIREBLADE (Japan)	900		1998	2003	R	
	M	CBR 900 RR-FIREBLADE (SC44&50)	900		2000	2003	R	
	M	CBR 929 RR-FIREBLADE	929		2000	2001	R	
	M	CRF 1000 L AFRICA TWIN	998	70	2016		R	
	M	CRF 1000 L AFRICA TWIN Adventure Sport-DCT	998	70	2018		R	
	M	CB 1000 SF	1000		1993	1997	R	
	M	CBF 1000	1000		2006		R	
	M	CBF 1000 F ABS	1000		2011		R	
	M	CBR 1000 BIG ONE	1000		1993	1997	R	
	M	CBR 1000 FIREBLADE	1000		2004	2005	R	
	M	CBR 1000 FIREBLADE - Racing Applications	1000		2004	2005	R	
	M	VTR 1000 FV FIRESTORM - SUPERHAWK	1000		1997	2000	R	
	M	VTR 1000 SP-1 (SC45)	1000		2000	2001	R	
	M	VTR 1000 SP-1 (Japan)	1000		2000	2004	R	
	M	VTR 1000 SP-2 (SC45)	1000		2002		R	
	M	CRF 1100L Africa Twin Adventure Sports	1100	75	2020		R	
	M	CRF 1100L Africa Twin DCT	1100	75	2020		R	



		CC	KW	FROM	TO	FRONT / REAR	LEFT / RIGHT
M	1100 AMERICAN CLASSIC EDITION	1100		1995		R	
M	CB 1100	1100		2013		R	
M	CB 1100	1100		2017		R	
M	CB 1100 EX	1100		2015		R	
M	CB 1100 RS	1100	66	2017		R	
M	VT 1100 C2 SHADOW	1100		1995		R	
M	CB 1300	1300		2001		R	
M	CB 1300 S	1300		2011		R	
M	VT 1300 CX	1300		2010		R	
M	VTX 1300 S / C	1300		2003		R	
KAWASAKI	M Vulcan S Cafe	649		2017		R	
M	Ninja 650	650	50	2017		R	
M	Versys 650 ABS (LE650E) FGF	650	51	2015		R	
M	Versys 650 (LE650E) EGF	650	51	2015		R	
M	Vulcan S	650	45	2015		R	
M	Z 750 R	750		2011		R	
M	Z 750 / Z 750 S	750		2007		R	
M	ZH2	998		2020		R	
M	KLZ VERSYS 1000	1000		2012		R	
M	KLZ VERSYS 1000	1000		2015		R	
M	Z 1000	1000		2007	2009	R	
M	Versys 1000	1043	88	2019		R	right
M	Versys 1000 SE	1043	88	2019		R	
SUZUKI	M DL V-STROM 650 XK NO ABS	650		2007	2011	R	
M	DL V-STROM 650 AK ABS	650		2007	2011	R	
M	DL V-STROM 650AK GT Traveller ABS	650		2007	2011	R	
M	DL V-STROM 650AL XP Xpedition ABS	650		2010	2011	R	
M	DL V-STROM 650 AL ABS	650		2012		R	
M	DL V-STROM 650 A XT ABS	650		2015		R	
M	GSF 650 (Naked Bandid Non ABS)	650		2007	2011	R	
M	GSF 650 A (Naked Bandid -ABS)	650		2005	2006	R	
M	GSF 650 A (Naked Bandid ABS)	650		2007	2011	R	
M	GSF 650 S (Faired Bandid Non ABS)	650		2007	2011	R	
M	GSF 650 SA (Faired Bandid -ABS)	650		2005	2006	R	
M	GSF 650 SA (Faired Bandid ABS)	650		2007		R	
M	GSX 650F (NO ABS)	650		2008	2011	R	
M	GSX 650F (ABS)	650		2008		R	
M	SV 650 (Naked - Non ABS)	650		2003	2010	R	
M	SV 650 S (Top Fairing - Non ABS)	650		2003	2012	R	
M	SV 650 A (Naked - ABS)	650		2007	2010	R	
M	SV 650 SA (Top Fairing - ABS)	650		2007	2013	R	
M	V-Strom 650 ABS	650		2016		R	
M	V-Strom 650-XT ABS	650		2016		R	
M	XF 650 FREEWIND	650		1997	2002	R	
M	GSR 750 ABS&NO ABS	750		2011		R	
M	GSX-S 750 ABS	750		2016		R	
M	DL 1000 V-STROM (WVBS)	1000	72	2002	2010	R	
M	GSX-S 1000 F ABS	1000		2015		R	



		CC	KW	FROM	TO	FRONT / REAR	LEFT / RIGHT
M	GSX-S 1000 ABS	1000		2015		R	
M	SV 1000 K3/SK3	1000		2003		R	
M	GSF 1250 (Naked Bandid - Non ABS)	1250		2007	2011	R	
M	GSF 1250 A (Naked Bandid - ABS)	1250		2007	2010	R	
M	GSF 1250 S (Faired Bandid - Non ABS)	1250		2007	2010	R	
M	GSF 1250 SA (Faired Bandid - ABS)	1250		2007	2012	R	
M	GSF 1250 SA (Faired Bandid - ABS)	1250		2015		R	
M	GSX 1250 FA	1250		2010		R	
M	GSX 1250 FA ST (Sport Touring)	1250		2010		R	
TRIUMPH	M BABY SPEED 600	600		2004		R	
M	DAYTONA 600	600		2003		R	
YAMAHA	M FZ6 600 / FZ6 600 FAZER ABS	600		2004	2007	R	
M	FZ6 600 S2 / FZ6 600 FAZER S2 ABS	600		2007	2009	R	
M	XJ6-F Diversion 600 (Non ABS&ABS models)	600		2013		R	
M	XJ6-N Diversion 600 (Non ABS&ABS models)	600		2013		R	
M	XJ6-S Diversion 600 (Non ABS&ABS models)	600		2013		R	
M	XJ6-SP Diversion 600 (NON ABS&ABS models)	600		2013	2013	R	
M	YZF 600 R6	600		2003	2004	R	
M	YZF 600 R6	600		2005	2016	R	
M	Tracer 700 ABS	689	55	2018		R	
M	MT-07 (RM04)	700	34	2014		R	
M	MT-07 (RM04)	700	55	2014		R	
M	MT-07 Motocage ABS	700		2015		R	
M	Tracer 700 GT	700	55	2019		R	
M	Tracer 700	700		2020		R	
M	XSR 700 ABS (RM11)	700	55	2016		R	
M	XSR 700 ABS (RM11)	700	35	2016		R	
M	XSR 700 Xtribute	700	55	2019		R	
M	FAZER 8 (NO ABS/ABS)	800		2011		R	
M	FZ8 NO ABS	800		2011		R	
M	FZ8 ABS	800		2011		R	
M	MT-09 SP ABS	847	85	2018		R	
M	Tracer 900 ABS	847	85	2018		R	
M	Tracer 900 GT	847	85	2018		R	
M	XSR 900 Abarth ABS	847	85	2018		R	
M	MT-09 (RN29)	850	85	2014		R	
M	MT-09 SR ABS	850		2014		R	
M	MT-09 Sport Tracker ABS	850		2015		R	
M	MT-09 Tracer ABS	850	85	2016	2017	R	
M	MT-09 Street Rally / ABS	850		2016		R	
M	XSR 900 ABS	900	85	2016		R	
M	MT-10 Tourer ed. ABS	998	118	2018		R	
M	FZ1 1000 (NO ABS/ABS)	1000		2006		R	
M	FZ1 1000 Fazer (NO ABS/ ABS)	1000		2006		R	
M	MT-10	1000		2016		R	
M	MT-10 SP	1000		2017		R	
M	YZF 1000 R1	1000		2004	2006	R	
M	YZF 1000 R1	1000		2007	2014	R	

M = MOTORCYCLE
S = SCOOTER
A = ATV
Sn = SNOWMOBILE

FDB781

102.0 x 41.0 x 10.0 mm

MATERIAL AVAILABILITY											
AG	EF	P	PRP	ST	SM	SG	ZR	XRAC	ZRAC	CP1	CPRO
	✓	✓		✓							

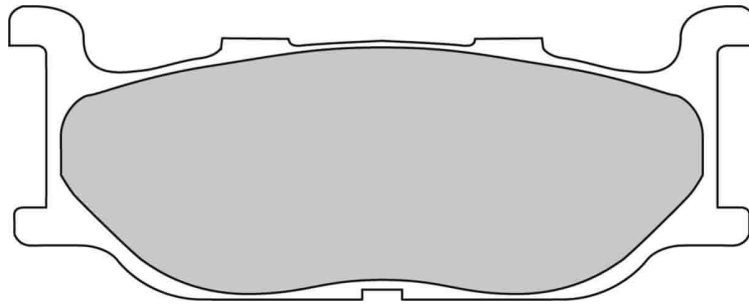

Pinze / Calipers

Pro-One

Pro -One 4-Piston - Old

CROSS REFERENCE

BRAKING	750
BREMBO	07YA27
BREMBO	7073
BRENTA	3057
BRENTA	4057
CL BRAKES	2391
EBC	FA179
GALFER	FD142
GOLD FREN	048
LUCAS/TRW	MCB640
NEWFREN	FD0183
SBS	663
VESRAH	VD-255

		CC	KW	FROM	TO	FRONT REAR	LEFT RIGHT		
	CFMOTO	M	CF 250 T - 5 Custom	250		2011	2012	F	
	SYM	M	SB125 N - Wolf (Carb Model/Drum Rear Brake)	125		2011		F	
	YAMAHA	M	TDR 125 R	125		1993	2003	F	
		M	FZX 250 ZEAL	250		1991		F	
		M	SRV 250 SOULFULTWIN RENAISSA	250		1992	1997	F	
		M	TY 250 Z SCOTTISH	250		1996		F	
		M	SR 400 (BC-RH01J)	400		2001		F	
		M	SR 400 (RH051)	400		2014		F	
		M	XVS 400	400		1998	1999	F	
		S	YP 400 MAJESTY	400		2004	2004	F	
		M	TMAX 500 (5SJ1)	500	29	2001	2003	F	
		M	XV 535 VIRAGO	535		1995	1998	F	
		M	600 DIVERSION	600		1992	1997	F	
		M	XJ 600 S	600		1992	1997	F	
		M	XVS 650 DRAG STAR	650		1997		F	

		CC	KW	FROM	TO	FRONT REAR	LEFT RIGHT
	M	XVS 650 A DRAG STAR CLASSIC	650		1998		F
	M	XV 750 VIRAGO	750		1994	1997	F
	M	XJ 900 SECA DIVERSION	900		1995	2003	F
	M	SCR 950 ABS	950		2017		F
	M	XV 950 (NO ABS&ABS)	950		2014		F
	M	XV 950 R ABS	950		2014		F
	M	XV950 Racer	950		2017		F
	M	XVS 950 A Midnight Star	950		2009	2013	F
	M	XVS 950 (Non ABS/Standard Rear Shocks)	950		2014		F
	M	XVS 950 (1XC1/ABS/Standard Rear Shocks)	950		2014		F
	M	XVS 950 R (2DE/Remote Reservoir Rear Shocks)	950		2014		F
	M	XV 1100 VIRAGO	1100		1994	1998	F
	M	XVS 1300 Custom (VP36)	1300		2014		F
	M	XVZ 1300 TF VENTURE STAR	1300		1999	2001	F
	M	XV 1600 A WILD STAR	1600		1999		F

FDB782

87.4 x 53.1 x 7.6 mm

MATERIAL AVAILABILITY											
AG	EF	P	PRP	ST	SM	SG	ZR	XRAC	ZRAC	CP1	CPRO
		✓									

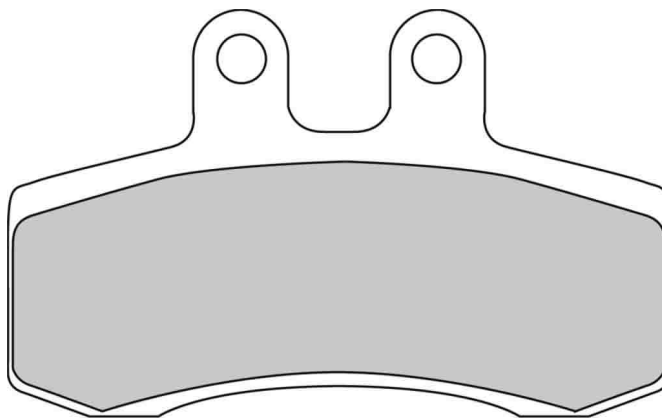

CROSS REFERENCE	
BREMBO	07GR21
EBC	FA177
GALFER	FD132
LUCAS/TRW	MCB652
NEWFREN	FD0171
SBS	681
VESRAH	VD-982

		CC	KW	FROM	TO	FRONT REAR	LEFT RIGHT
	APRILIA						
M	PEGASO 650	650		1991	1995	F	

		CC	KW	FROM	TO	FRONT REAR	LEFT RIGHT
	MZ						
M	BAGHIRA / MASTIFF	660		2000		F	

M = MOTORCYCLE
S = SCOOTER
A = ATV
Sn = SNOWMOBILE

FDB783

75.1 x 36.1 x 7.6 mm

MATERIAL AVAILABILITY											
AG	EF	P	PRP	ST	SM	SG	ZR	XRAC	ZRAC	CP1	CPRO
✓											

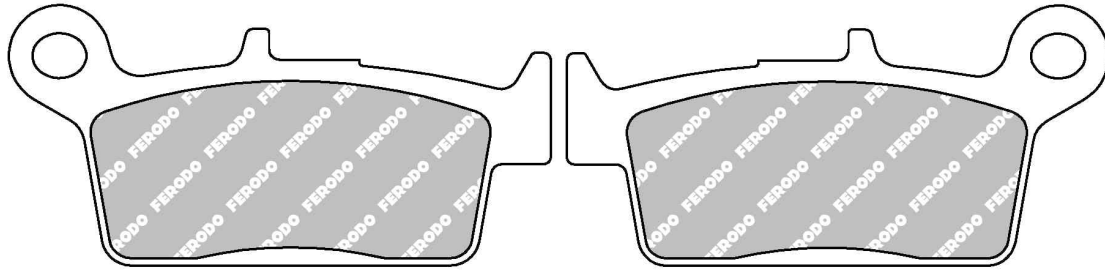

ALSO AVAILABLE		
SHAPE	TH. MM	NOTES
FDB539	9.7	
FDB672	9.1	

CROSS REFERENCE	
BREMBO	07010
BREMBO	7010
EBC	SFA131/2
GALFER	FD147
GOLD FREN	071
LUCAS/TRW	MCB650
NEWFREN	FD0178
SBS	673
VESRAH	VD-144
VESRAH	VD-144/3

		CC	KW	FROM	TO	FRONT / REAR	LEFT / RIGHT		
	HONDA	M	NSR 75 (NS-1)	75		1992	2000	R	
	PEUGEOT	M	SV 50 GEO	50		1992		F	

		CC	KW	FROM	TO	FRONT / REAR	LEFT / RIGHT	
	M	ZENITH 50	50		1994	1995	F	
	M	SV 125 GEO	125		1991	1992	F	

FDB784

31.7 x 51.1 x 5.6 mm

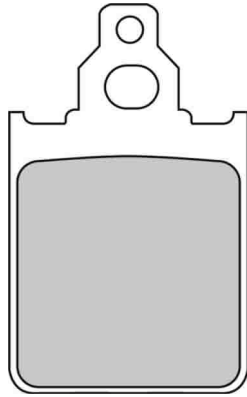

MATERIAL AVAILABILITY											
AG	EF	P	PRP	ST	SM	SG	ZR	XRAC	ZRAC	CP1	CPRO
✓	✓										

ALSO AVAILABLE		
SHAPE	TH. MM	NOTES
FDB2100	6.0	Different friction material area

Pinze / Calipers

GMA

BP Series

Grimeca

6-Piston, Castle Top: 911-755

CROSS REFERENCE

BRAKING	760
BREMBO	07013
BREMBO	7013
BRENTA	3025
CL BRAKES	2260
CL BRAKES	3005
EBC	FA186
EBC	SFA186
GALFER	FD152
LUCAS/TRW	MCB651
NEWFREN	FD0194
SBS	117
SBS	680
VESRAH	VD-949

		CC	KW	FROM	TO	FRONT REAR	LEFT RIGHT
	ITALJET						
	M FORMULA 50	50		1994	1996	F	
	M FORMULA 80	80		1994		F	
	M FORMULA 125	125		1994	1996	F	
LML	S Star Deluxe 125 (2T/Disc model)	125		2001	2003	F	
	S Star 125 (2T) All Models	125		2010	2014	F	
	S Star 125i (4T) All Models	125		2010		F	
	S Star Deluxe 150 (2T/Disc model)	150		2001	2003	F	
	S Star 150 (2T) All Models	150		2010	2014	F	

		CC	KW	FROM	TO	FRONT REAR	LEFT RIGHT
	S Star 150 (4T) All Models	150		2010	2014	F	
	S Star 151i (4T) All Models	151		2010		F	
	S Star 200i (4T) All Models	200		2010		F	
PIAGGIO	M QUARTZ 50	50		1992	1996	F	
	M SKIPPER 80	80		1994	1996	F	
	M SKIPPER 125	125		1993	1997	F	
	M SKIPPER 150	150		1993	1997	F	

M = MOTORCYCLE
S = SCOOTER
A = ATV
Sn = SNOWMOBILE

FDB828

85.0 x 42.7 x 7.5 mm / 56.0 x 34.5 x 9.8 mm

MATERIAL AVAILABILITY

AG	EF	P	PRP	ST	SM	SG	ZR	XRAC	ZRAC	CP1	CPO
		✓		✓							

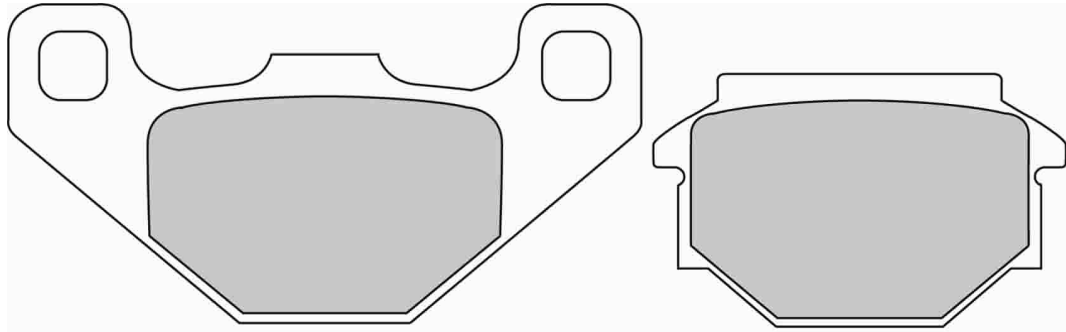

CROSS REFERENCE

BRAKING	743
BREMBO	07014
BREMBO	07015
BREMBO	07GR04
CL BRAKES	2472
CL BRAKES	3012
CL BRAKES	3024
EBC	FA173
EBC	FA372
EBC	FA382
GALFER	FD135
LUCAS/TRW	MCB657
NEWFREN	FD0165
SBS	684

		CC	KW	FROM	TO	FRONT REAR	LEFT RIGHT
	M ETX 125	125		1998		R	
	M MX 125	125		2004	2006	R	
	M PEGASO 125	125		1989		R	
	M PEGASO 125 KAT	125		1994		R	
	M RX 125	125		1990	1991	R	
	M RX 125	125		1992	1994	R	
	M RX 125	125		1995	2002	R	
	M SX 125	125		2008	2017	R	
	M TUAREG 125 RALLY	125		1989	1990	R	
	M TUAREG 125 RALLY	125		1991		R	
	M PEGASO 600	600		1990		R	
	M TUAREG 600 WIND	600	34	1988	1990	R	
	M TUAREG 600 WIND PARIS-DAKAR	600	34	1989	1989	R	
	M MOTO 650 6.5	650		1995	1999	R	
	M PEGASO 650	650		1991	1995	R	
M PEGASO 650	650		1996	2000	R		
CAGIVA	M WMX 50	50		1989		R	
	M N 90 ENDURO	90		1990		R	
FANTIC	M BIG WHEEL 50	50		1994		R	
	M GRINTA 50	50		1995		R	

		CC	KW	FROM	TO	FRONT REAR	LEFT RIGHT
	M LEADER 50	50		1995		R	
	M BIG WHEEL 50	50		1993	1994	R	
GILERA	M EAGLET 50	50		1996		R	
	M RC 50 TOP RALLY	50		1990	1995	F	
	M RC 50 TOP RALLY	50		1990	1995	R	
HONDA-HM ITALIA	M CRE 50 (from frame nr.2819)	50				R	
	M CRE 50 Baja	50		2011		R	
	M CRM 50 Derapage	50		2011		R	
	M CRE Baja HM 125 4T	125		2011		R	
	M CRE Baja RR HM 125 4T	125		2011		R	
	M CRM 125 4T Derapage HM	125		2011		R	
LEM	M FLASH 50	50		1994		F	
MALAGUTI	M F 10 50 JETLINE	50		1992	1993	F	
MZ	M BAGHIRA / MASTIFF	660		2000		R	
RIEJU	M RS2 50 FR / PRO	50		2008		R	
	M RS2 50 PRO	50		2009		R	
	M NKD 125	125		2008		R	
SACHS	M XTC 125 SUPERSPORT	125		2000		R	
	M ZX 125	125		2001		R	
SUZUKI ATV	A LT-A/F 500 FK VINSON 4WD	500		2003	2007	R	

FDB847

111.8 x 56.0 x 11.0 mm

MATERIAL AVAILABILITY											
AG	EF	P	PRP	ST	SM	SG	ZR	XRAC	ZRAC	CP1	CPRO
		✓									

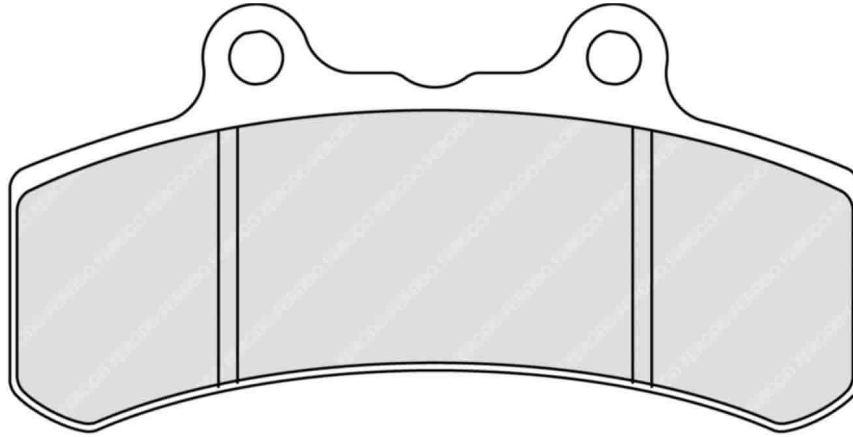

Pinze / Calipers

Performance Machine

137x6 6-Piston

CROSS REFERENCE	
BREMBO	07HD11
CL BRAKES	2369
EBC	FA210
LUCAS/TRW	MCB635
NEWFREN	FD0270
SBS	658
VESRAH	VD-975



	CC	KW	FROM TO		FRONT	LEFT		
			REAR	RIGHT				
BUELL	M	M2 Cyclone, S1 Lightning, S2-S3 Thunderbolt	1200		1994	1997	F	

FDB858

69.8 x 52.5 x 8.7 mm

MATERIAL AVAILABILITY											
AG	EF	P	PRP	ST	SM	SG	ZR	XRAC	ZRAC	CP1	CPRO
				✓						✓	

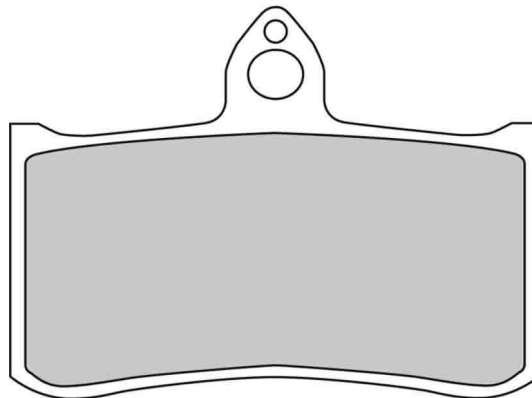

Pinze / Calipers

Honda

Honda 4 Piston, Brembo / Honda RS

Nissin

Nissin 4Pot Axial Mnt Racing/billet

CROSS REFERENCE	
BRAKING	756
BRENTA	4136
EBC	FA239
NEWFREN	FD0198

M = MOTORCYCLE
S = SCOOTER
A = ATV
Sn = SNOWMOBILE

		CC	KW	FROM	TO	FRONT / REAR	LEFT / RIGHT
HONDA	M	RS 125 R	125	1995	2010	F	
	M	NSR 250 R SP	250	1994	1996	F	
	M	NSR 250 R SE	250	1994	1996	F	
	M	RS 250	250	1993	1994	F	

		CC	KW	FROM	TO	FRONT / REAR	LEFT / RIGHT
M	M	RVF 400	400	1994		F	
	M	CBR 750 SUPER AERO	750	1988	1989	R	
	M	RVF 750 RR (RC 45)	750	1994		F	

FDB864

98.9 x 49.7 x 9.9 mm

MATERIAL AVAILABILITY											
AG	EF	P	PRP	ST	SM	SG	ZR	XRAC	ZRAC	CP1	CPRO
		✓	✗	✓							

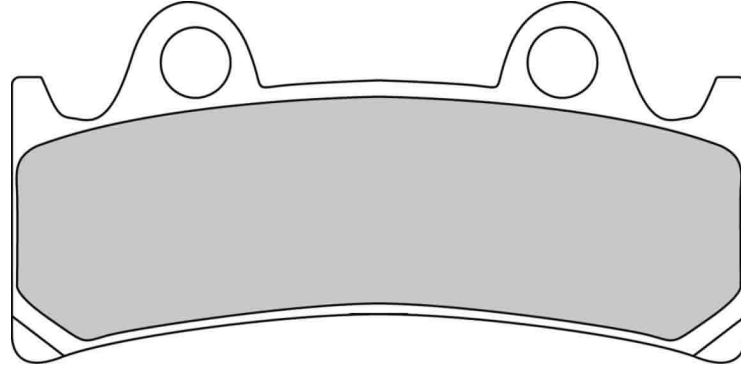

Pinze / Calipers

GMA

S Series (6-Piston)

Performance Machine

125x6 6-Piston

CROSS REFERENCE

BREMBO	07YA32
CL BRAKES	2254
EBC	FA190
GALFER	FD157
LUCAS/TRW	MCB656
NEWFREN	FD0201
SBS	683
VESRAH	VD-258

		CC	KW	FROM	TO	FRONT / REAR	LEFT / RIGHT
TRIUMPH	M	DAYTONA SUPER III 900	900	1994	1997	F	
	M	YZF 750 RR-SP	750	1993	1998	F	

		CC	KW	FROM	TO	FRONT / REAR	LEFT / RIGHT
M	M	FZR 1000 GENESIS - EX-UP	1000	1994	1995	F	
	M	FZR 1000 R	1000	1994	1995	F	

FDB873

90.0 x 52.0 x 8.0 mm

MATERIAL AVAILABILITY											
AG	EF	P	PRP	ST	SM	SG	ZR	XRAC	ZRAC	CP1	CPRO
	✓	✓	✗	✓				✓	✓	⚠	✓

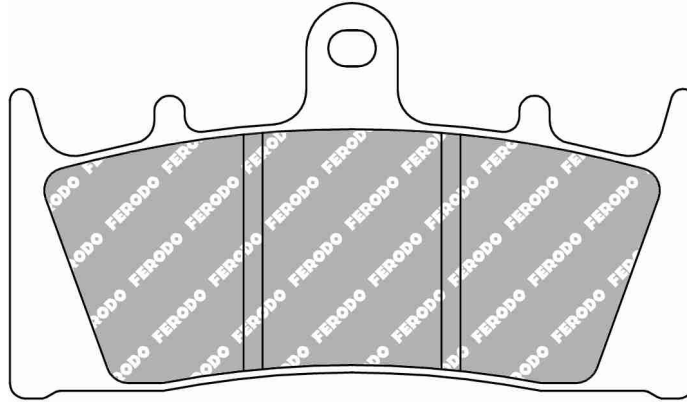

ALSO AVAILABLE		
SHAPE	TH. MM	NOTES
FDB2144	9.9	Racing Applications

Pinze / Calipers

FD (Discacciati)

6-Piston

CROSS REFERENCE	
BRAKING	764
BREMBO	07SU19
BRENTA	3060
BRENTA	4060
CL BRAKES	2255
EBC	FA188
GALFER	FD156
GOLD FREN	039
LUCAS/TRW	MCB659
NEWFREN	FD0199
SBS	686
VESRAH	VD-349

		CC	KW	FROM	TO	FRONT / REAR	LEFT / RIGHT
	KAWASAKI						
	M ZRX 400	400		1998		F	
	M ZX 6R 600 NINJA	600		1998	2001	F	
	M ZX-7 750 R NINJA	750		1996	2003	F	
	M ZX-9R 900 R NINJA (B1 - B2)	900		1996	1997	F	
	M ZX-9R 900 R NINJA (B1 - B2)	900		1998	1999	F	
	M ZX-9R 900 R NINJA (B3 - B4) (C1 - C2) (E1 - E2)	900		2000	2001	F	
	M ZR 1100 C1	1100		1997	2000	F	
M ZRX 1200 R - S	1200		2001		F		
M ZX 12 1200 R	1200		2000	2003	F		

		CC	KW	FROM	TO	FRONT / REAR	LEFT / RIGHT
	SUZUKI						
	M MEAN STREAK 1500	1500		2002	2003	F	
	M VN 1600 MEAN STREAK	1600		2004		F	
	M GSX-R 750 W	750		1994	1999	F	
	M GSX-R 1000	1000		2001	2002	F	
	M TL 1000 R	1000		1998	2002	F	
	M GSX-R 1100 W	1100		1993	1996	F	
	M GSF 1200 K1/SK1 BANDIT	1200		2001		F	
	M GSX 1400	1400		2002		F	
	M VZ 1600 MARAUDER	1600		2004		F	

M = MOTORCYCLE
S = SCOOTER
A = ATV
Sn = SNOWMOBILE

FDB887

117.1 x 58.8 x 8.0 mm

MATERIAL AVAILABILITY											
AG	EF	P	PRP	ST	SM	SG	ZR	XRAC	ZRAC	CP1	CPRO
		✓									

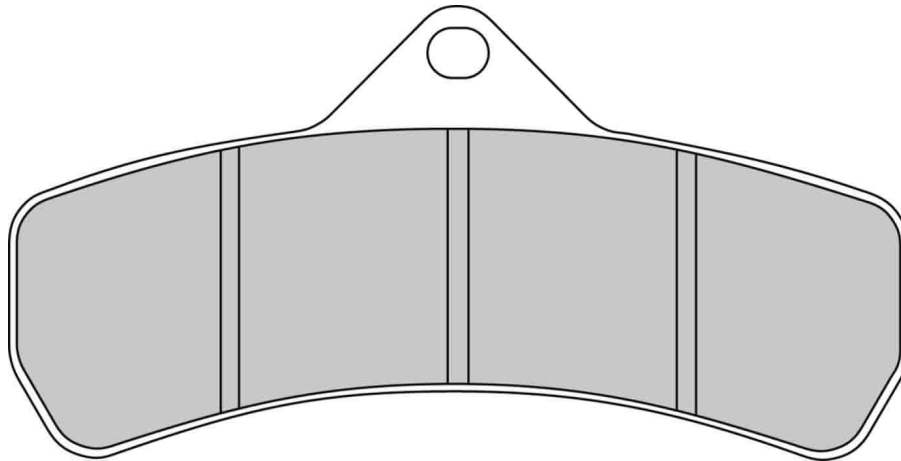

Pinze / Calipers

Spiegler

8-Piston

CROSS REFERENCE	
CL BRAKES	2586
NEWFREN	FD0204

FDB889

39.9 x 54.1 x 6.5 mm

April 2017: AG superseded by EF

MATERIAL AVAILABILITY											
AG	EF	P	PRP	ST	SM	SG	ZR	XRAC	ZRAC	CP1	CPRO
✗	✓			✓							

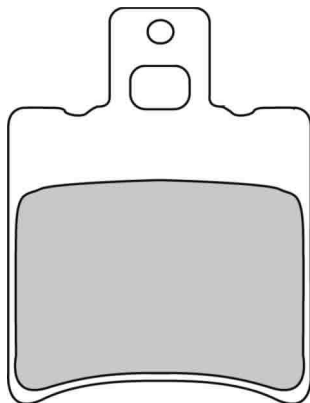



Pinze / Calipers

BREMBO

2-Piston/Small (P30A)

CROSS REFERENCE	
BRAKING	779
BREMBO	07086
BREMBO	07YA29
BREMBO	7086
BRENTA	3011
BRENTA	4011
CL BRAKES	2307
EBC	old FA206
EBC	SFA193
GALFER	FD171
GOLD FREN	107
LUCAS/TRW	MCB644
NEWFREN	FD0197
SBS	114
SBS	667
VESRAH	VD-256

		CC	KW	FROM	TO	FRONT / REAR	LEFT / RIGHT
							
APRILIA	S SR 50 all models	50		1993	1996	F	
DERBI	M VAMOS 50 R	50		1995		F	
MBK	M BOOSTER 50 R	50		1994	1995	F	
	M BOOSTER 50 NEXT GENERATION	50		1996	1998	F	
	M BOOSTER 50 TRACK	50		1996	1998	F	
	M BOOSTER 50 / SPIRIT	50		1996		F	
	M EVOLIS 50	50		1992		F	
	M FIZZ 50	50		1994		F	
	M FORTE 50	50		1995		F	
	M NITRO 50	50		1997		F	
	M OVETTO 50	50		1997		F	
	M ROCKET 50	50		1996	1998	F	
	M EVOLIS 80	80		1994		F	

		CC	KW	FROM	TO	FRONT / REAR	LEFT / RIGHT
							
MONTESA	M COTA 315 R	315		1998		R	
PGO	M MY BUBU 50	50		2003		F	
SUZUKI	M AP 50	50		1995	2002	F	
YAMAHA	M CW 50 RS	50		1995		F	
	M EW 50 SLIDER	50		2000	2003	F	
	M JOG 50 Z (Italia) - R / RR	50		1993		F	
	M YE 50 ZEST	50		1992		F	
	M YE 50 ZEST	50		1993	1995	F	
	M YH 50 WHY	50		1999		F	
	S YQ 50 AEROX / AEROX R	50		1997	2012	F	
	M YN 100 NEO'S	100		2000	2003	F	
	M YQ 100 AEROX	100		2000	2002	F	
	M XN 125 N TEO'S	125		2000	2003	F	

FDB892

94.2 x 34.1 x 7.7 mm

Compound P senza intaglio/P compound without slot; ZR=sintered compound for premium Motocross and Supercross

MATERIAL AVAILABILITY											
AG	EF	P	PRP	ST	SM	SG	ZR	XRAC	ZRAC	CP1	CPRO
	✓	✓				✓	✓				✓

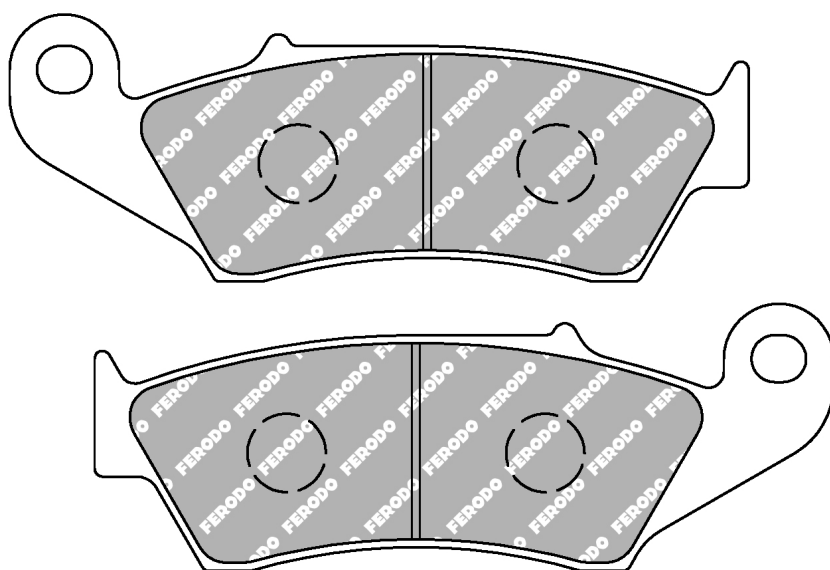

CROSS REFERENCE	
BRAKING	772
BREMBO	07KA17
CL BRAKES	2300
EBC	FA185
GALFER	FD164
LUCAS/TRW	MCB669
NEWFREN	FD0193
SBS	694
VESRAH	VD-161

		CC	KW	FROM	TO	FRONT / REAR	LEFT / RIGHT
							
AJP	M PR5 250 Enduro	250		2009	2009	F	
	M PR5 250 Supermoto	250		2009	2009	F	
APRILIA	M MXV 450	450		2008		F	
	M RXV 450 / Rally / Merriman Replica	450		2005		F	
	M RXV 550	550		2005		F	
BETA	M RR Enduro 125 2T	125		2018		F	
	M RR 250 4T Enduro	250		2005	2007	F	
	M RR 250 2T Enduro	250		2015		F	
	M RR 300 2T Enduro	300		2015		F	
	M XTRAINER 300	300		2015		F	
	M RR 350 4T Enduro	350		2011		F	

		CC	KW	FROM	TO	FRONT / REAR	LEFT / RIGHT
							
	M RR 350 EFI 4T Enduro	350		2015		F	
	M RR 390 4T Enduro	390		2015		F	
	M RR 400 4T Enduro	400		2005		F	
	M RR 430 4T Enduro	430		2015		F	
	M RR 450 4T Enduro	450		2005	2013	F	
	M RR 450 4T Cross Country	450		2012		F	
	M RR 480 4T Enduro	480		2015		F	
	M RR 498 4T Enduro	500		2012		F	
	M RR 520 4T Enduro	520		2010	2011	F	
	M RR 525 4T Enduro	525		2005	2009	F	
CANNONDALE	M MX 400	400		2000	2002	F	

M = MOTORCYCLE
S = SCOOTER
A = ATV
Sn = SNOWMOBILE



		CC	KW	FROM	TO	FRONT / REAR	LEFT / RIGHT
	M 440 (All Enduro / MX Models)	440		2003		F	
	M S 440 SUPERMOTO	440		2003		F	
GASGAS	M EC / MC 125	125		2000		F	
	M EC 200	200		2001		F	
	M EC / MC 250	250		2000		F	
	M EC / MC 300	300		2000		F	
	M EC 400	400		2001		F	
	M FSE 450	450		2004		F	
HONDA	M CR 125 RW - RX - RY - R1	125		1996	2001	F	
	M CR 125 R	125		2002	2007	F	
	M CRF 125 F (Small wheel 17"-14")	125		2014	2016	F	
	M CRF 125 FB (Big wheel 19"-16")	125		2014	2018	F	
	M XLR 125	125		1993		F	
	M CRF 150 F	150		2003	2007	F	
	M NX 150 (Brasil)	150				F	
	M CTX 200	200		2003	2004	F	
	M NX 200 (Brasil)	200				F	
	M XLR 200 R	200		1993		F	
	M XR 200 (Brasil)	200				F	
	M CRF 230 F	230		2003	2007	F	
	M CRF 230 F	230		2008		F	
	M EASY 230 Enduro /SM	230		2008		F	
	M SL 230	230		1997		F	
	M CR 250 R	250		1996	2001	F	
	M CR 250 R	250		2002	2007	F	
	M CRF 250 R	250		2004		F	
	M CRF 250 X	250		2004	2017	F	
	M CRM 250 R	250		1991		F	
	M NX 250 DOMINATOR	250		1991	1993	F	
	M XL 250 DEGREE	250		1991	1997	F	
	M XLR 250 R	250		1991		F	
	M XLR 250 R BAJA	250		1991		F	
	M XR 250 L	250		1991	1995	F	
	M XR 250 R	250		1994		F	
	M NX 350 SAHARA (Brasil)	350			1999	F	
	M XR 400 R (All Models)	400		1996		F	
	M XR 440 R (DALL'ARA)	440		1999		F	
	M CRF 450 SUPERMOTARD	450		2002		F	
	M CRF 450 Rally	450		2013		F	
	M CRF 450 L	450	18	2019		F	
	M CRF 450 R	450		2002		F	
	M CRF 450 R	450		2017		F	
	M CRF 450 RX	450		2017		F	
	M CRF 450 X	450		2005	2013	F	
	M CR 500 R	500		1993	1994	F	
	M CR 500 R	500		1995	2001	F	
	M XL 600 V TRANSALP	600		1997	1999	F	
	M XR 600 L - R	600		1994	2002	F	
	M NX 650 DOMINATOR	650		1995	1997	F	
	M XL 650 V TRANSALP	650		2000		F	
	M XR 650 L	650		1996		F	
	M XR 650 R	650		1999		F	
	M XL 700 V TRANSALP (No ABS Front)	680	44	2007		F	
	M XR V 750 AFRICA TWIN (RD07)	750	37	1994	2003	F	
	M XR V 750 AFRICA TWIN (RD07)	750	44	1994	2003	F	
HONDA ATV	A TRX 450 R/ER	450		2004	2009	F	
	A TRX 700 XX (8/XX9)	700		2008	2009	F	
HONDA-HM ITALIA	M CRE 50 Six Racing	50		2011		F	
	M CRE 125 2T /Six Comp	125		2002		F	
	M CRE 125 4T Six Racing	125		2011		F	
	M CRE 250 / CRE F250 X/R	250		2002		F	
	M CRE F300 X	300		2008		F	
	M CRE F450 X/R	450		2008		F	



		CC	KW	FROM	TO	FRONT / REAR	LEFT / RIGHT
	M CRE F450 R	450		2011		F	
	M CRE F500 X	500		2009		F	
KAWASAKI	M KX 125 K2-K4	125		1995	1997	F	
	M KX 125	125		1996	2002	F	
	M KX 125	125		2003		F	
	M KDX 200 E6 / H1 - H3	200		1994	2003	F	
	M KDX 220 RA4	220		1997	2003	F	
	M KDX 250 K2-K4	250		1995		F	
	M KLX 250	250		1993	1997	F	
	M KLX 250 D-Tracker	250		1998	2003	F	
	M KLX 250 S	250		2006	2007	F	
	M KX 250	250		1994	1995	F	
	M KX 250	250		1996	2002	F	
	M KX 250	250		2003		F	
	M KX 250 F	250		2004		F	
	M KLX 300 R	300		1997	2003	F	
	M KLX 450 R	450		2007		F	
	M KX 450	450		2019		F	
	M KX 450 F	450		2006		F	
	M KX 500	500		1994	1995	F	
	M KX 500 E8/E9	500		1996		F	
	M KLX 600 R	600		1993		F	
	M KLX 650 R	650		1993	1997	F	
SUZUKI	M DR 125 SM	125		2008		F	
	M RM 125 T - U - V	125		1996	1998	F	
	M RM 125 X - Y - K1	125		1999	2008	F	
	M RM 125	125		2009		F	
	M RM 125 E	125		2009		F	
	M SM 125	125		2010		F	
	M RM 250 T/V	250		1996	1999	F	
	M RM 250	250		2000	2008	F	
	M RM 250	250		2009		F	
	M RM-Z 250	250		2004	2018	F	
	M RM-Z 250 / E	250		2009		F	
	M RM-Z 250	250		2019		F	
	M RMX 250 T/V	250		1996	1998	F	
	M RMX 250	250		2000	2002	F	
	M DR-Z 400 S	400		2000		F	
	M DR-Z 400 E	400		2000		F	
	M DR-Z 400 SM	400		2005		F	
	M RM-Z 450	450		2005	2007	F	
	M RM-Z 450 / E	450		2008		F	
	M RMX 450 E	450		2009		F	
	M SM 450X	450		2009		F	
	M DR 650 SE	650		1996		F	
YAMAHA	M YZ 125 all models	125		1998	2002	F	
	M YZ 125	125		2003	2007	F	
	M WR 250 (ZK 2T - FN&FT 4T)	250		1998	2002	F	
	M WR 250 F (4T)	250		2003	2016	F	
	M WR 250 R (32D1/3)	250		2008	2010	F	
	M WR 250 F	250		2017		F	
	M YZ 250 K/L/M	250		1998	2000	F	
	M YZ 250 N-P (2T)	250		2001	2002	F	
	M YZ 250 FN-FP (4T)	250		2001	2002	F	
	M YZ 250 (2T)	250		2003	2007	F	
	M YZ 250 F (4T)	250		2003	2006	F	
	M WR 400 F	400		1998		F	
	M WR 400 F	400		1999	2001	F	
	M YZ 400 F	400		1998		F	
	M WR 426 FN	426		2001	2002	F	
	M YZ 426 FM / FN	426		2000	2002	F	
	M WR 450 F	450		2003		F	
	M YZ 450 F	450		2003	2007	F	

FDB2001

104.0 x 62.0 x 11.2 mm

MATERIAL AVAILABILITY											
AG	EF	P	PRP	ST	SM	SG	ZR	XRAC	ZRAC	CP1	CPRO
		✓	✓			✓					

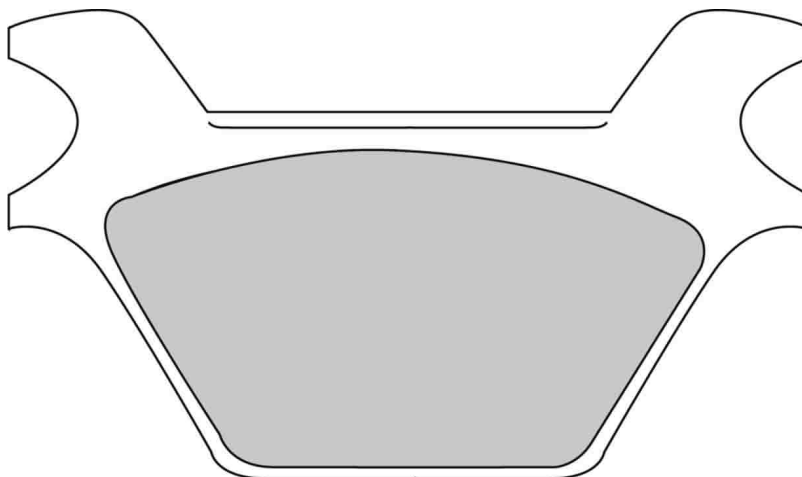

CROSS REFERENCE	
BRAKING	734
BREMBO	07HD10
CL BRAKES	2370
EBC	FA200
EBC	Old FA139
GALFER	FD126
LUCAS/TRW	MCB583
NEWFREN	FD0150
SBS	669
VESRAH	VD-957

		CC	KW	FROM	TO	FRONT REAR	LEFT RIGHT
	HARLEY DAVIDSON						
	S XL 883 EVO	883		1987	1999	R	
	M XLH Sportster 883 Hugger	883		1992	1993	R	
	M XL 1200 EVO	1200			1999	R	
	M FLST Heritage Softail	1340			1990	R	
	M FLSTC Heritage Softail Classic	1340		1987	1999	R	
	S FLSTF Fat Boy	1340		1990	1999	R	
	S FLSTN Heritage Softail	1340		1993	1996	R	
	M FLSTS Heritage Springer Softail	1340		1997	1999	R	
	M FXD Dyna Super Glide	1340		1995	1999	R	
	M FXDB Dyna Street Bob	1340		1991	1992	R	
	M FXDC Dyna Super Glide Custom	1340		1991	1992	R	
	M FXDG Dyna Glide Sturgis	1340		1991		R	
	M FXDL Low Rider	1340		1993	1999	R	
	M FXDS-Conv. / Dyna Convertible	1340		1994	1999	R	
	M FXDWG Wide Glide	1340		1993	1999	R	
	M FXDX Dyna Super Glide Sport	1340		1995	1999	R	
	M FXLR Low Rider Custom	1340			1994	R	
	M FXR Super Glide	1340			1994	R	

		CC	KW	FROM	TO	FRONT REAR	LEFT RIGHT
	POLARIS SNOWMOBILE						
	M FXRS Low Glide	1340			1992	R	
	M FXRT Sport Glide	1340			1992	R	
	M FXST Softail Standard	1340		1999		R	
	M FXSTB Night Train	1340		1999	1999	R	
	M FXSTC Softail Custom	1340			1999	R	
	M FXSTS Springer Softail	1340			1999	R	
	M FXSTSB Bad Boy	1340		1995	1997	R	
	Sn HAYES (all models)				1993	1998	R
	Sn INDY RXL - RMK - SKS				1993	1997	R
	Sn INDY SPORT - TOURING				1993	1998	R
	Sn INDY TRAIL - DE LUXE				1993	1998	R
	Sn INDY XLT (all models)				1993	1998	R
	Sn INDY TRANSPORT				1996	1998	R
	Sn INDY ULTRA (all models)				1996	1998	R
	Sn INDY 440 XCR	440			1993	1999	R
	Sn XCF 440	440			1998	2000	R
	Sn INDY 600 XCR - SP	600			1996	1999	R

M = MOTORCYCLE
S = SCOOTER
A = ATV
Sn = SNOWMOBILE

FDB2002

125.0 x 44.3 x 8.8 mm

MATERIAL AVAILABILITY											
AG	EF	P	PRP	ST	SM	SG	ZR	XRAC	ZRAC	CP1	CPRO
		✓		✓							

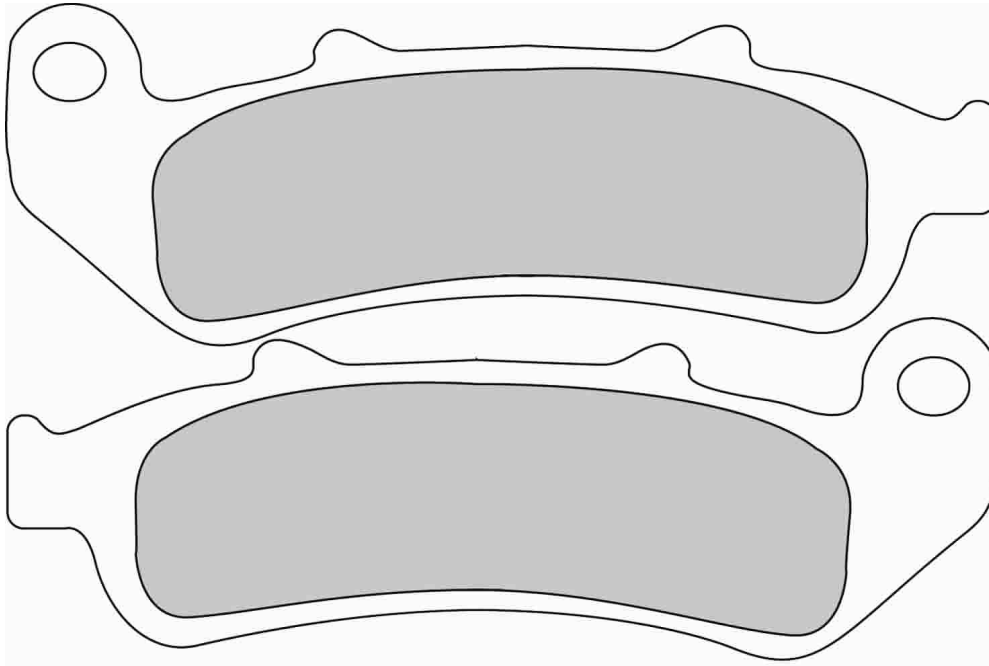

CROSS REFERENCE	
BREMBO	07HO39
CL BRAKES	2257
EBC	FA189
GALFER	FD155
LUCAS/TRW	MCB658
NEWFREN	FD0203
SBS	685
VESRAH	VD-164

HONDA	M	CBR 1000 F-FP	CC	KW	FROM TO		FRONT	LEFT
					REAR	RIGHT		
			1000		1993	1999	F	

HONDA	M	CBR 1000 F-FP	CC	KW	FROM TO		FRONT	LEFT
					REAR	RIGHT		
			1000		1993	1999	R	

FDB2003

94.0 x 41.0 x 10.0 mm

September 2016: AG superseded by EF

MATERIAL AVAILABILITY											
AG	EF	P	PRP	ST	SM	SG	ZR	XRAC	ZRAC	CP1	CPR0
✗	✓	✓		✓	✓						

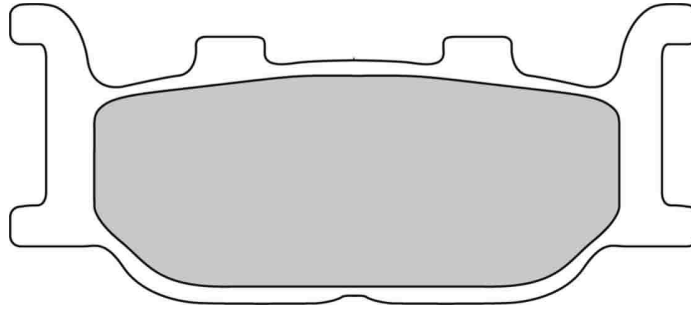

CROSS REFERENCE	
BRAKING	777
BREMBO	07042
BREMBO	07YA34
BREMBO	7042
BRENTA	3019
BRENTA	4019
CL BRAKES	2546
CL BRAKES	3025
EBC	FA199
GALFER	FD169
GOLD FREN	099
LUCAS/TRW	MCB666
NEWFREN	FD0205
SBS	128
SBS	691
VESRAH	VD-260

		CC	KW	FROM	TO	FRONT / REAR	LEFT / RIGHT
	ADIVA	S	AD 125	125	2009	2011	R
		S	AR 125	125	2010	2011	R
		S	AD 200	200	2009	2011	R
		S	AR 200	200	2010	2011	R
ITALJET	M	JUPITER 125	125	2001		F	
	M	JUPITER 125 / 150 / 250	125	2002	2003	F	
	M	JUPITER 250	250	2001		F	
KTM	M	SX 450 SMR	450	2005	2006	R	
	M	SX 525 SMR	525	2005		R	
LINHAI	M	Monarch 125 T	125	2006		F	
	M	Monarch 150 T	150	2006		F	
	M	Main Street 300 (Scooter)	300	2007		F	
MBK	M	SKYLINER 250	250	2000	2002	F	
	S	SKYLINER 400	400	2004		F	
SINNIS	M	QM 125-2 V Max 125	125	2008	2010	F	
YAMAHA	M	SR 125	125	1997	2003	F	
	M	TDR 125	125	1993	1993	F	
	M	TZR 125	125	1993		F	
	M	XV 125 VIRAGO	125	1997	2000	F	
	M	XVS 125 DRAG STAR	125	2000		F	
	S	CP 250 (1B71) Maxam/Morphus	250	2005	2008	F	
	M	XV 250 S VIRAGO	250	1995	2000	F	
M	XVS 250 DRAGSTAR	250	2001	2004	F		

		CC	KW	FROM	TO	FRONT / REAR	LEFT / RIGHT	
	M	YP 250 MAJESTY	250	1996	1997	F		
	M	YP 250 A MAJESTY	250	2000		F		
	M	YP 250 MAJESTY DX - ABS	250	1998	1999	F		
	M	XJ 400 DIVERSION - R	400	1991	1994	F		
	M	XJR 400 R	400	1997		F		
	S	YP 400 MAJESTY (NO ABS)	400	2005		F		
	S	YP 400 MAJESTY (ABS)	400	2007		F		
	S	TMAX 500 (SJ03)	500	33	2004	2007	F	
	M	FZ6 600 / FZ6 600 FAZER ABS	600	2004	2007	F		
	M	FZ6R 600	600	2009		F		
	M	XJ 600 S	600	1998	2003	F		
	M	XJ6-F Diversion 600 (Non ABS&ABS models)	600	2010	2013	F		
	M	XJ6-F Diversion 600 (Non ABS&ABS models)	600	2013		F		
	M	XJ6-N Diversion 600 (Non ABS&ABS models)	600	2009	2013	F		
	M	XJ6-N Diversion 600 (Non ABS&ABS models)	600	2013		F		
	M	XJ6-S Diversion 600 (Non ABS&ABS models)	600	2009	2013	F		
	M	XJ6-S Diversion 600 (Non ABS&ABS models)	600	2013		F		
	M	XJ6-SP Diversion 600 (NON ABS&ABS models)	600	2013	2013	F		
	M	MT-03 660	660	2008		F		
	M	XVS 1100 DRAG STAR / CLASSIC	1100	1999		F		
M	FJ 1200	1200	1999		F			
M	XVS 1300 A Midnight Star (VP26)	1300	2007		F			
M	XVS 1300 A CFD	1300	2014		F			

M = MOTORCYCLE
S = SCOOTER
A = ATV
Sn = SNOWMOBILE

FDB2005

78.3 x 41.3 x 9.15 mm

replacing FDB2019

MATERIAL AVAILABILITY											
AG	EF	P	PRP	ST	SM	SG	ZR	XRAC	ZRAC	CP1	CPRO
	✓	✓		✓		✓					

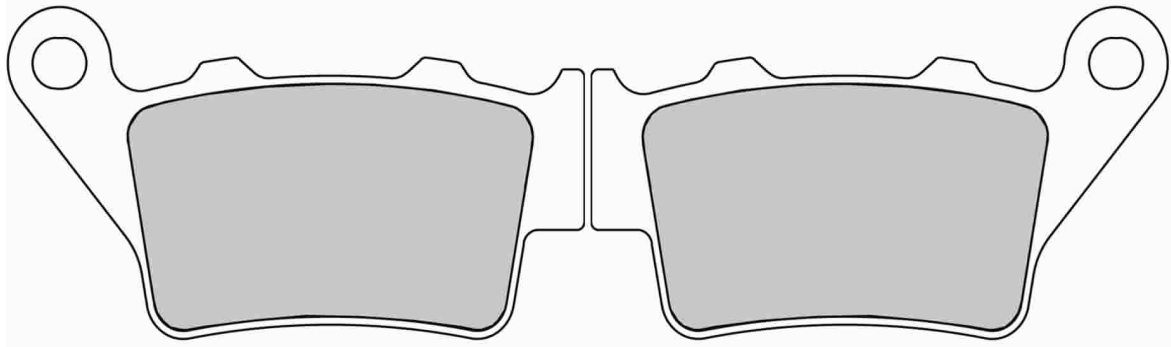

CROSS REFERENCE	
BRAKING	773
BREMBO	07BB02
BRENTA	3088
BRENTA	4088
CL BRAKES	2353
COBREQ	N-932
EBC	FA208
EBC	FA213
FRAS-LE	PD/863
GALFER	FD165
GOLD FREN	023
LUCAS/TRW	MCB672
NEWFREN	FD0206
SBS	675
VESRAH	VD-953

		CC	KW	FROM	TO	FRONT / REAR	LEFT / RIGHT
	ALFER						
	M NO LIMITS 250	250		1995		R	
	M VR 250 ENDURO	250		1995		R	
	M VR 250 MOTOCROSS	250		1995		R	
	M VR 250 SUPERMOTARD	250		1999		R	
APRILIA	M PEGASO 650 / I.E.	650		2001	2004	R	
	M PEGASO 650 STRADA	650		2004		R	
	M PEGASO 650 TRAIL	650		2007		R	
	M PEGASO 650 Factory	650		2008		R	
	M SL 750 SHIVER ABS / GT	750		2008		R	
	M SMV 750 Dorsoduro (NO ABS/ABS)	750		2008		R	
	M SMV 750 Dorsoduro FACTORY	750		2010		R	
	M Dorsoduro	900		2017		R	
	M Shiver	900		2017		R	
	M CAPONORD 1200	1200		2013		R	
	M CAPONORD 1200 Rally	1200		2015		R	
	M DORSODURO 1200 / ABS / ATC	1200		2011		R	
	ATK (USA)	M all models 1996-01			1996	2001	R
M 500 Dirt Track		500		1998	1999	R	
M 600 Dirt Track		600		1998	1999	R	
BAJAJ	M Pulsar 200 NS	199	18	2011		R	
	M Pulsar 200 RS	199	18	2011		R	
	M Pulsar 200 NS	200		2009		R	
BENELLI	M BX Cross (449cc)	449		2007	2012	R	
	M BX 449 Motard	449		2010		R	
	M BX Enduro (505cc)	505		2008	2012	R	
	M BX 570 Motard	570		2008	2010	R	
BETA	M JONATHAN 125	125		1999	2001	R	
	M JONATHAN 125	125		2002	2005	R	
	M EURO 350	350		1999	2001	R	
	M EURO 350	350		2002		R	
BMW	M C1 125 Scooter	125		2000	2003	R	
	M C1 200 Scooter	200		2001	2003	R	
	M G 310 GS	313		2017		R	
	M G 310 R	313		2016		R	

		CC	KW	FROM	TO	FRONT / REAR	LEFT / RIGHT
	S	C400	400		2018		R
	S	C 400 GT	400	25	2019		R
	M	F 650 / 650 ST	650		1994	2000	R
	M	F 650 CS	650		2001		R
	M	F 650 SCARVER	650		2002		R
	M	F 650 GS	650		2001	2008	R
	M	G650 GS	650		2011		R
	M	G 650 X Challenge / X Country	650		2007		R
	M	G 650 X Moto	650		2008		R
	M	F700 GS	700	25	2013		R
	M	F700 GS	700	35	2013		R
	M	F700 GS	700	52	2013		R
	M	F700 GS	700	55	2013		R
	M	F750 GS	750		2018		R
	M	F800 GT	800		2013		R
	M	F800 R	800		2015		R
	M	F 650 GS (K72)	800		2008	2012	R
	M	F800 S / ST / R	800		2007		R
	M	F800 GS	800	35	2008		R
	M	F800 GS	800	61	2008		R
	M	F800 GS	800	63	2008		R
	M	F800 GS Triple Black	800	63	2011		R
	M	F800 GS Trophy	800	63	2011		R
	M	F800 GS Adventure	800		2012		R
	M	F 850 GS Rallye	850	70	2019		R
	M	F850 GS	850		2018		R
	M	F 850 GS Adventure	850		2020		R
	M	R 850 RT	850		1998	2001	R
	M	F 900 R	895	77	2020		R
	M	F 900 XR	895	77	2020		R
	M	HP4 1000 (K42)	1000		2013		R
	M	S1000 R Naked (K47)	1000		2014		R
	M	S1000 RR (K46)	1000		2010	2014	R
	M	S1000 RR	1000	152	2015	2018	R



		CC	KW	FROM	TO	FRONT / RÉAR	LEFT / RIGHT
M	690 DUKE R	690		2010	2012	R	
M	690 DUKE (ABS Std)	690	54	2012		R	
M	690 DUKE R (ABS Std)	690		2014		R	
M	690 ENDURO R	690	46	2008		R	
M	LC4 690 SUPERMOTO Prestige	690		2007		R	
M	690 SM	690		2007		R	
M	690 SMC R (ABS Std)	690	55	2013		R	
M	690 SMR / SMC / DUKE / SupermotoR	690		2008		R	
M	Duke 790 Prototype	790		2017		R	
M	790 DUKE	799	77	2018		R	
M	790 DUKE	799	77	2019		R	
M	890 Duker	890		2020		R	right
M	DUKE 950 / 990 / 990 RC8	950		2003		R	
M	990 SUPERDUKE	990		2005	2011	R	
M	990 SUPERDUKE R	990		2007		R	
MAICO	M 250 CROSS	250		1998		R	
M	500 CROSS	500		1998		R	
ROYAL ENFIELD	M Thunderbird 350	346	15	2014		R	
M	Thunderbird	350		2012		R	
M	Continental GT	535		2014		R	
SWM	M Super Dual	650		2015		R	
TM	M 80 (Big wheel)	80		2002	2004	R	
M	80 Cross	80		1996	2001	R	
M	80 Enduro	80		1996	2000	R	
M	80 Junior Cross (Small wheel)	80		2002	2004	R	
M	85 (Big wheel)	85		2002	2004	R	
M	85 Cross	85		1996	2001	R	
M	85 Junior Cross (Small wheel)	85		2002	2004	R	
M	100 (Big wheel)	100		2002	2004	R	
M	100 Junior Cross (Small wheel)	100		2002	2004	R	



		CC	KW	FROM	TO	FRONT / RÉAR	LEFT / RIGHT
M	125 Cross	125		1995	2000	R	
M	125 Enduro	125		1995	2000	R	
M	250 Cross	250		1995	2000	R	
M	250 Enduro	250		1995	2000	R	
M	300 Cross	300		1995	2000	R	
M	300 Enduro (2T)	300		1995	2000	R	
M	400 Cross (4T)	400		1995	2000	R	
M	530 Cross (4T)	530		1998	2000	R	
TRIUMPH	M DAYTONA 675	675		2013		R	
M	DAYTONA 675 R	675		2013		R	
M	STREET TRIPLE 675	675		2013		R	
M	STREET TRIPLE 675 R	675		2013		R	
M	STREET TRIPLE 675 Rx	675		2015		R	
M	STREET TRIPLE 765 RS	765		2017		R	
M	STREET TRIPLE 765 S	765		2017		R	
M	STREET TRIPLE 765 R	765		2017		R	
M	Street Triple 765 R Low	765		2019		R	
M	Bonneville Speedmaster	1200	57	2019		R	
YAMAHA	M WR 125 R	125		2009	2013	R	
M	WR 125 X (Supermoto)	125		2009		R	
M	TT 600 R	600		1998	1999	R	
M	TT 600 RE	600		2004		R	
M	TT-R 600 R	600		2000	2003	R	
M	MT-03 660	660		2008		R	
M	XT 660 R	660		2004		R	
M	XT 660 X Supermoto	660		2004		R	
M	XT 660 Z TENERE (Non ABS)	660		2008		R	
M	XT 660 ZA TENERE (ABS)	660		2011	2011	R	
M	Tenere 700	689	54	2019		R	
M	Tenere' 700 World Raid Proto	689		2018		R	

FDB2006

108.5 x 40.0 x 7.7 mm

MATERIAL AVAILABILITY

AG	EF	P	PRP	ST	SM	SG	ZR	XRAC	ZRAC	CP1	CPRO
	✓	✓		✓							

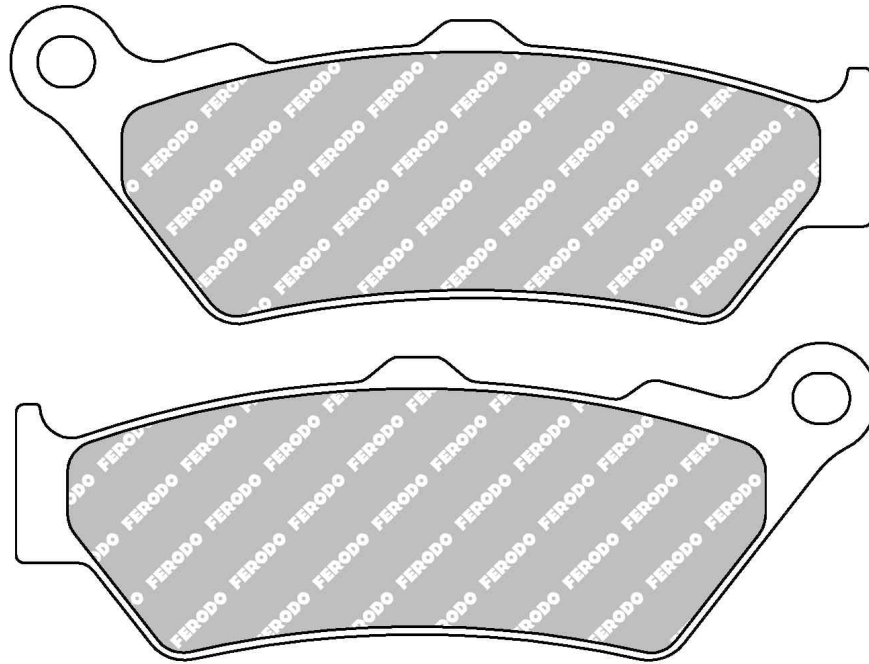

CROSS REFERENCE

BRAKING	780
BREMBO	07BB03
BREMBO	7083
BRENTA	3090
BRENTA	4090
CL BRAKES	2396
COBREQ	N-934
EBC	FA209
EBC	FA209/2
FRAS-LE	PD/862
GALFER	FD172
GOLD FREN	106
LUCAS/TRW	MCB671
NEWFREN	FD0216
SBS	674
VESRAH	VD-958

		CC	KW	FROM	TO	FRONT REAR	LEFT RIGHT
	M RS 125	125		1998	1999	F	
	M PEGASO 600	600		1990		F	
	M MOTO 650 6.5	650		1995	1999	F	
	M PEGASO 650	650		1996	2000	F	
	M PEGASO 650 / I.E.	650		2001	2004	F	
	M PEGASO 650 TRAIL	650		2007		F	
	M ETV 1000 CAPONORD / RALLY RAID	1000		2001	2007	F	
BIMOTA	M DBX	1078		2013		F	
BMW	M C1 125 Scooter	125		2000	2003	F	
	M C1 200 Scooter	200		2001	2003	F	
	M F 650 / 650 ST	650		1994	2000	F	
	M F 650 CS	650		2001		F	
	M F 650 SCARVER	650		2002		F	
	M F 650 GS	650		2001	2008	F	
	M G650 GS	650		2011		F	
	M G 650 X Challenge / X Country	650		2007		F	
	M F700 GS	700	25	2013		F	
	M F700 GS	700	35	2013		F	
	M F700 GS	700	52	2013		F	
M F700 GS	700	55	2013		F		
M F750 GS	750		2018		F		

		CC	KW	FROM	TO	FRONT REAR	LEFT RIGHT
	M F 650 GS (K72)	800		2008	2012	F	
	M F800 GS	800	35	2008		F	
	M F800 GS	800	61	2008		F	
	M F800 GS	800	63	2008		F	
	M F800 GS Triple Black	800	63	2011		F	
	M F800 GS Trophy	800	63	2011		F	
	M F800 GS Adventure	800		2012		F	
	M F 850 GS Rallye	850	70	2019		F	
	M F850 GS	850		2018		F	
	M F 850 GS Adventure	850		2020		F	
	M HP2 Enduro 1200	1200		2004	2006	F	
	M R 1200 RT (K52)	1200		2014		R	
	M R 1200 R (K53)	1200		2015		R	
	M R 1200 RS	1200		2015		R	
	M R 1200 GS Adventure (K51)	1200	81	2013		R	
	M R 1200 GS (K50)	1200	92	2013		R	
	M R 1200 GS (K50)	1200	79	2013		R	
	M R 1200 GS Exclusive	1200		2017		R	
	M R 1200 GS Rallye	1200		2017		R	
	M R 1250 GS Adventure	1250	100	2019		R	
	M R 1250 GS	1250	100	2019		R	

M = MOTORCYCLE
S = SCOOTER
A = ATV
Sn = SNOWMOBILE



		CC	KW	FROM	TO	FRONT / REAR	LEFT / RIGHT
	M R 1250 RT	1250	100	2019		R	
	M R 1250 R	1250	100	2019		R	
	M R 1250 RS	1250	100	2019		R	
	M K 1600 GT	1600		2011		R	
	M K 1600 GTL	1600		2011		R	
	M K 1600 B Grand America	1600		2018		R	
	M K 1600 B	1649		2017		R	
DUCATI	M SCRAMBLER Sixty2 (KA)	399	30	2016		F	
	M Scrambler Sixty2	400	30	2017		F	
	M GT 1000	1000		2006	2007	F	
	M Sportclassic GT 1000 / SPORT 1000S / Touring	1000		2008		F	
	M PAUL SMART 1000 Limited Edition	1000		2007		F	
	M SPORT 1000	1000		2006		F	
	M DIAVEL 1200 (ABS Std)	1198		2011		R	
	M DIAVEL STRADA 1200 (ABS Std)	1198		2014		R	
	M DIAVEL DARK 1200 (ABS Std)	1198		2014		R	
	M DIAVEL CARBON 1200 (ABS Std)	1198		2014		R	
	M DIAVEL TITANIUM 1200 (ABS Std)	1198		2015		R	
	M Diavel Diesel	1198	112	2018		R	
	M Diavel 1260	1262	117	2019		R	
	M Diavel 1260 S	1262	117	2019		R	
	M XDIAVEL	1262		2016		R	
	M XDIAVEL S	1262		2016		R	
HARLEY DAVIDSON	M XG 750A Street Rod	749		2018		F	
	M XG 750 Street	749		2016		F	
HONDA	M CB 500 S	500		1999	2003	F	
	M CB 500 V	500		1997	2003	F	
	M NX 500 DOMINATOR	500		1997	1999	F	
	M NT 650 V DEAUVILLE	650		1998	2001	F	
	M NX 650 DOMINATOR	650		1998	2002	F	
	M SLR 650	650		1997	1998	F	
	M VIGOR 650	650		1999	2002	F	
HUSQVARNA	M BAJA	650		2013		F	
	M Moab	650		2012		F	
	M TR 650 Strada (Cast Wheel)	650		2012	2013	F	
	M TR 650 Terra (Spoke Wheel)	650		2012	2013	F	
KTM	M 690 ENDURO R	690	46	2008		F	
	M ADVENTURE 950	950		2003		F	
	M 950 R SUPERENDURO	950		2006	2008	F	
	M 990 ADVENTURE ABS	990		2008		F	
	M 990 ADVENTURE R	990		2008		F	
MOTO GUZZI	M 940 - Bellagio	940		2007	2012	F	
	M BELLAGIO 1000 / Aquila Nera	1000		2008		F	



		CC	KW	FROM	TO	FRONT / REAR	LEFT / RIGHT
	M CENTAURO 1000	1000		1996	1999	R	
	M CALIFORNIA 1100 EV	1100		1997	2000	R	
	M CALIFORNIA 1100	1100		1997	2001	R	
	M CALIFORNIA (all models)	1100		2001	2006	R	
	M California 1100 Classic Touring	1100		2006	2008	R	
	M California 1100 Vintage	1100		2006	2012	R	
	M California 1100 Aquila Nera	1100		2009	2011	R	
	M California 1100 90	1100		2012	2012	R	
	M CENTAURO 1100 V11 SPORT	1100		1999	2000	R	
	M QUOTA 1100 ES	1100		1999	2001	F	
	M GRAN PASSO 1200 / H83	1200		2010		F	
	M SCRAMBLER 1200	1200		2010		F	
	M Audace	1380		2016		R	
	M Audace Carbon	1380		2017		R	
	M California Touring SE	1380		2016		R	
	M Eldorado	1380		2016		R	
	M California 1400 Custom	1400		2013		R	
	M California 1400 Touring	1400		2013		R	
	M MGX-21 Flying fortress	1400		2016		R	
MOTO MORINI	M Granpasso 1200 / H83	1200		2008		F	
	M Scrambler 1200	1200		2008		F	
ROYAL ENFIELD	M Continental GT	535		2014		F	
TRIUMPH	M Scrambler 1200 XE	1200	66	2019		R	
	M Scrambler 1200 XC	1200	66	2020		R	
	M THUNDERBIRD 1600	1600		2009		R	
	M THUNDERBIRD STORM 1700	1700		2011		R	
	M THUNDERBIRD COMANDER	1700		2014		R	
	M THUNDERBIRD LT	1700		2014		R	
	M THUNDERBIRD NIGHT STORM	1700		2015		R	
	M ROCKET III ROADSTER	2294		2010		R	
	M ROCKET X	2294		2015		R	
	M ROCKET 2300 /Rocket III Classic/Touring/Roadster	2300		2004		R	
VICTORY	M Hammer S				2007	R	
	M Hammer			2005	2007	R	
	M King Pin			2004	2007	R	
	M King Pin Tour			2004	2007	R	
	M Ness Signature Series			2005	2007	R	
	M V92SC			2000	2003	R	
	M Vegas			2003	2007	R	
	M Vegas 8-Ball			2005	2007	R	
	M Vegas Jackpot			2006	2007	R	
	M V92C (All models single front rotor)	1500		1998	2003	R	
YAMAHA	M XT 660 R	660		2004		F	

FDB2007

78.0 x 41.0 x 8.7 mm

MATERIAL AVAILABILITY											
AG	EF	P	PRP	ST	SM	SG	ZR	XRAC	ZRAC	CP1	CPRO
								✗		✓	🔄

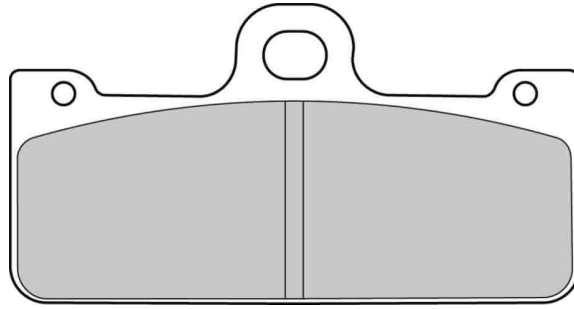

ALSO AVAILABLE		
SHAPE	TH. MM	NOTES
FDB2123	10.0	

Pinze / Calipers

BREMBO

XA93310/11 4-Piston/2 pads; Narrow (GP32/36-2pc), 8.3mm

PVM

4-Piston, 2 piece caliper, 2pad x 8mm

CROSS REFERENCE

BRAKING	776
BREMBO	07BB10
BREMBO	107684820 (Z01)
BREMBO	M028Z04 (Z04)
CL BRAKES	2329
EBC	FA218
GALFER	FD168
GOLD FREN	116
NEWFREN	FD0213
SBS	695
VESRAH	VD-969

		CC	KW	FROM	TO	FRONT / REAR	LEFT / RIGHT		
	APRILIA	M	SXV VDB Replica	450		2007	2007	F	
		M	SXV VDB Replica	550		2007	2007	F	
	DUCATI	M	748 RACING CLIENTI	748		1995	1997	F	

		CC	KW	FROM	TO	FRONT / REAR	LEFT / RIGHT		
	M	880 RACING	880			1994	1995	F	
	M	916 RACING CLIENTI	916			1995	1998	F	

FDB2012

68.0 x 54.5 x 9.8 mm / 90.0 x 51.5 x 8.7 mm

MATERIAL AVAILABILITY

AG	EF	P	PRP	ST	SM	SG	ZR	XRAC	ZRAC	CP1	CPRO
	✓	✓		✓							

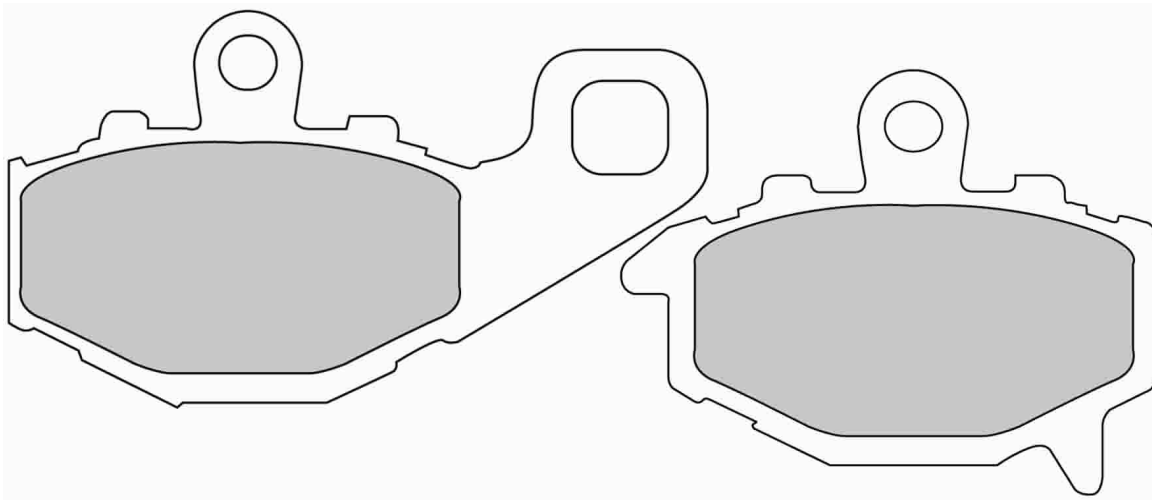

CROSS REFERENCE

BRAKING	775
BREMBO	07KA16
BRENTA	3089
BRENTA	4089
CL BRAKES	2381
EBC	FA192
GALFER	FD167
GOLD FREN	093
LUCAS/TRW	MCB662
NEWFREN	FD0207
SBS	687
VESRAH	VD-434

		CC	KW	FROM	TO	FRONT REAR	LEFT RIGHT
	M 650NK	650		2012	2014	R	
	M 650TR	650		2013	2014	R	
	M 650TK	650		2013	2014	R	
	M ZR 400 ZEPHYR	400		1993	1995	R	
	M ZRX 400	400		1998		R	
	M ZRX 400 (ZR 400 E2)	400		1999	2001	R	
	M ZXR 400	400		1994		R	
	M ZZR 400	400		1993		R	
	S ZR 550 ZEPHYR	550		1993	1999	R	
	M ZX 6RR (ZX 599 B1)	599		2003	2006	R	
	M ZX 6R 600 NINJA	600		1994	1997	R	
	M ZX 6R 600 NINJA	600		1998	2001	R	
	M ZX 6R 600 NINJA (Racing Applications)	600		1998	2001	R	
	M ZX 6R 600 NINJA	600		2007		R	
	M ZZR 600	600		1993		R	
	M ZX 6R (ZX 636 K1)	636		2003	2006	R	
	M ER-6 650 F	650		2005		R	
	M ER-6 650 N (ER650A)	650	53	2005	2008	R	
	M ER-6 650 N ABS (ER650A)	650	53	2005	2008	R	
	M ER-6 650 N (ER650A)	650	25	2006	2008	R	
M ER-6 650 N (ER650C)	650	25	2009	2011	R		
M ER-6 650 N (ER650C)	650	53	2009	2011	R		
M ER-6 650 N ABS	650	53	2011	2011	R		
M ER-6 650 N (ER650E)	650	25	2012		R		
M ER-6 650 N (ER650E)	650	35	2012		R		
M ER-6 650 N (ER650E)	650	53	2012		R		
M ER-6 650 N ABS (ER650E)	650	25	2012		R		
M ER-6 650 N ABS (ER650E)	650	35	2012		R		

		CC	KW	FROM	TO	FRONT REAR	LEFT RIGHT
	M ER-6 650 N ABS (ER650E)	650	53	2012		R	
	M Versys (LE650A)	650	53	2007	2009	R	left
	M Versys (LE650A)	650	47	2007	2009	R	left
	M Versys (LE650A)	650	25	2007	2009	R	left
	M Versys (LE650C)	650	47	2009	2013	R	
	M Versys (LE650C)	650	25	2009	2013	R	
	M Z 750 / Z 750 S	750		2004	2006	R	
	M X-9 R 900 NINJA	900		1994	1995	R	
	M ZX-9R 900 R NINJA (B1 - B2)	900		1994	1995	R	
	M ZX-9R 900 R NINJA (B1 - B2)	900		1996	1997	R	
	M ZX-9R 900 R NINJA (Racing Applications)	900		1996	1997	R	
	M ZX-9R 900 R NINJA (B1 - B2)	900		1998	1999	R	
	M ZX-9R 900 R NINJA (Racing Applications)	900		1998	1999	R	
	M ZX-9R 900 R NINJA (B3 - B4) (C1 - C2) (E1 - E2)	900		2000	2001	R	
	M ZX-9R 900 R NINJA (Racing Applications)	900		2000	2001	R	
	M ZX-9R 900 R NINJA F1-F2	900		2002	2004	R	
	M Z1000 Sugomi Ed.	1000		2016		R	
	M Z 1000 (ZR 1000 A1)	1000		2003	2006	R	
	M Z 1000 R Edition	1000		2017		R	
	M Z 1000 / ABS / SX	1000		2010		R	
	M Z 1000 / SE	1000		2012		R	
	M Z 1000 SX	1000		2012	2016	R	
	M Z 1000 SX	1000		2017		R	
	M ZX-10R 1000	1000	149	2004	2007	R	
	M ZX-10R 1000	1000	149	2008	2010	R	
	M Ninja 1000 SX	1043		2020		R	
	M GPZ 1100	1100		1995	1997	R	

FDB2013

56.0 x 37.0 x 10.3 mm / 85.0 x 36.0 x 7.9 mm

MATERIAL AVAILABILITY											
AG	EF	P	PRP	ST	SM	SG	ZR	XRAC	ZRAC	CP1	CPRO
						✓					

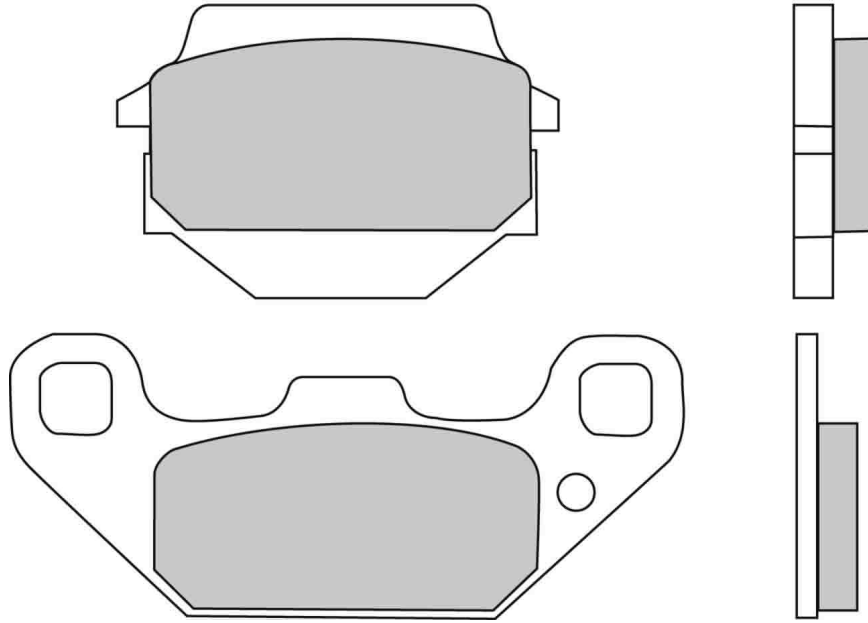

CROSS REFERENCE	
BREMBO	07SU11
CL BRAKES	2799
EBC	FA128
LUCAS/TRW	MCB560
NEWFREN	FD0110
SBS	591
VESRAH	VD-332

		CC	KW	FROM	TO	FRONT REAR	LEFT RIGHT
	A	KSF 250 MOJAVE A Series	250	1987	2005	F	
	A	KSF 250 A8 - A9	250	1994	1995	F	
	A	KXF 250 Tecate	250	1987	1988	F	
	A	KXF 250 Tecate	250	1989		F	
	A	KEF 300 LAKOTA A Series, LAKOTA SPORT B Series	300	1995	2003	F	
SUZUKI ATV	A	LT 230 S QUADSPORT	230	1985	1988	F	

		CC	KW	FROM	TO	FRONT REAR	LEFT RIGHT
	A	LT 230 EH/EJ/EK/EL/EM/EN/EP	230	1986	1993	F	
	A	LT 230 S QUADSPORT	230	1989		F	
	A	LT 250 R	250	1985	1986	F	
	A	LT 250 R	250	1987	1992	F	
	A	LT 250 S	250	1989	1990	F	
	A	LT 500 R	500	1987	1990	F	

M = MOTORCYCLE
S = SCOOTER
A = ATV
Sn = SNOWMOBILE

FDB2014

47.0 x 47.0 x 16.5 mm

MATERIAL AVAILABILITY											
AG	EF	P	PRP	ST	SM	SG	ZR	XRAC	ZRAC	CP1	CPRO
						✓					

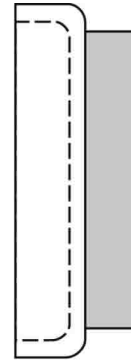
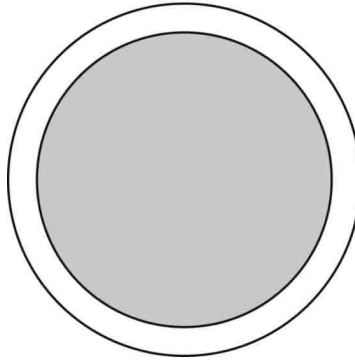

CROSS REFERENCE	
BREMBO	07YA15
EBC	FA021
LUCAS/TRW	MCB567
NEWFREN	FD0278
SBS	576
VESRAH	VD-234

		CC	KW	FROM	TO	FRONT REAR	LEFT RIGHT
YAMAHA 3 WHEELERS	A YT 125 G/H/J/K/L/N	125		1980	1985	R	
	A YT 175 J/K	175		1982	1983	R	
	A YTM 200 K/L/N	200		1983	1985	R	
	A YTM 200 EK/EL	200		1983	1984	R	
	A YTM 200 ERN	200		1985	2000	R	
	A YTM 225 DXK/DXL/DXN	225		1983	1985	R	
	A YTM 225 DRN/DRS	225		1985	1986	R	
YAMAHA ATV	A YFM 200 (Moto 4)	200		1985	1989	R	
	A YFM 225 (Moto 4)	225		1986	1988	R	
	A YFM 250 W/A/B	250		1989	1991	R	
	A YFM 350 ERT/ERU	350		1987	1988	R	
	A YFM 350 FW T/U	350		1987	1988	R	
	A YFM 350 FW T/U BIG BEAR	350		1987	1988	R	
A YFM 350 ER W/A/D	350		1989	1992	R		

		CC	KW	FROM	TO	FRONT REAR	LEFT RIGHT
	A YFM 350 FW W/A/B/D/E/F/G BIG BEAR	350		1989	1995	R	
	A YFM 350 ER E/F/G	350		1993	1995	R	
YAMAHA SNOWMOBILE	Sn EXCEL V			1979	1980	F	
	Sn EXCITER			1976	2000	F	
	Sn GPX (All Models)			1974	1975	F	
	Sn OVATION			1989	1993	F	
	Sn PHAZER			1984	1993	F	
	Sn SNO-SCOOT			1989	1991	F	
	Sn SPV			1980	1991	F	
	Sn SSR			1978	2000	F	
	Sn V-MAX			1983	1991	F	
	Sn XL-V			1985	1990	F	
Sn SS 440	440		1980	1993	F		
Sn VK X 440	440		1989	1991	F		

FDB2015

82.6 x 22.0 x 7.0 mm

MATERIAL AVAILABILITY											
AG	EF	P	PRP	ST	SM	SG	ZR	XRAC	ZRAC	CP1	CPRO
						✓					

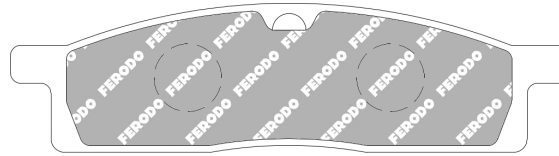

CROSS REFERENCE	
BRAKING	705
BREMBO	07YA16
CL BRAKES	2424
EBC	FA119
GALFER	FD097
LUCAS/TRW	MCB558
NEWFREN	FD0102
SBS	589
VESRAH	VD-244

		CC	KW	FROM	TO	FRONT REAR	LEFT RIGHT		
	KAWASAKI	M	KLE 250 ANHELO	250		2000	2002	R	
	YAMAHA	M	DT 50 LCD	50		1996	1998	F	
		M	YZ 65	65		2018		F	
		M	YZ 80	80		1986	1992	F	

		CC	KW	FROM	TO	FRONT REAR	LEFT RIGHT
	M	YZ 80	80		1993	2001	F
	M	YZ 85 LW	85		2002		F
	M	TT-R 125 LW	125		2000	2012	F

FDB2016

47.0 x 45.0 x 7.3 mm

MATERIAL AVAILABILITY											
AG	EF	P	PRP	ST	SM	SG	ZR	XRAC	ZRAC	CP1	CPRO
						✓					

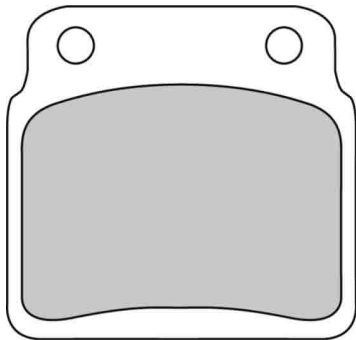

CROSS REFERENCE	
BREMBO	07SU29
EBC	FA137
LUCAS/TRW	MCB626
NEWFREN	FD0145
SBS	649
VESRAH	VD-341

M = MOTORCYCLE
S = SCOOTER
A = ATV
Sn = SNOWMOBILE



			CC	KW	FROM	TO	FRONT / REAR	LEFT / RIGHT
ARCTIC CAT	A	400 DVX	400		2004	2008	R	
HYOSUNG ATV	A	RAPIER 450 /S	450		2008		F	
	A	RAPIER 450 /S	450		2008		R	
KAWASAKI ATV	A	KSF 400 / KFX 400	400		2004	2006	R	
	A	KSF 450 / KFX 450	450		2007		R	
SUZUKI ATV	A	LT 250 R	250		1987	1992	R	
	A	LT-Z 400 QUADSPORT	400		2003	2012	R	
	A	LT-A 450 X KING QUAD 4X4	450		2007	2010	R	



			CC	KW	FROM	TO	FRONT / REAR	LEFT / RIGHT
	A	LT-R 450 K/Z	450		2006		R	
	A	LT-R 450 Z Quad Racer	450		2008		R	
	A	LT 500 R	500		1987	1990	R	
	A	LT-A 500 KING QUAD XP	500		2009	2012	R	
	A	LT-A 500 KING QUAD X	500		2012	2012	R	
	A	LT-A 700 KING QUAD	700		2005	2007	R	
	A	LT-A 750 KING QUAD X	750		2008	2012	R	

FDB2018

93.6 x 36.4 x 7.7 mm



ZR= sintered compound for premium Motocross and Supercross use

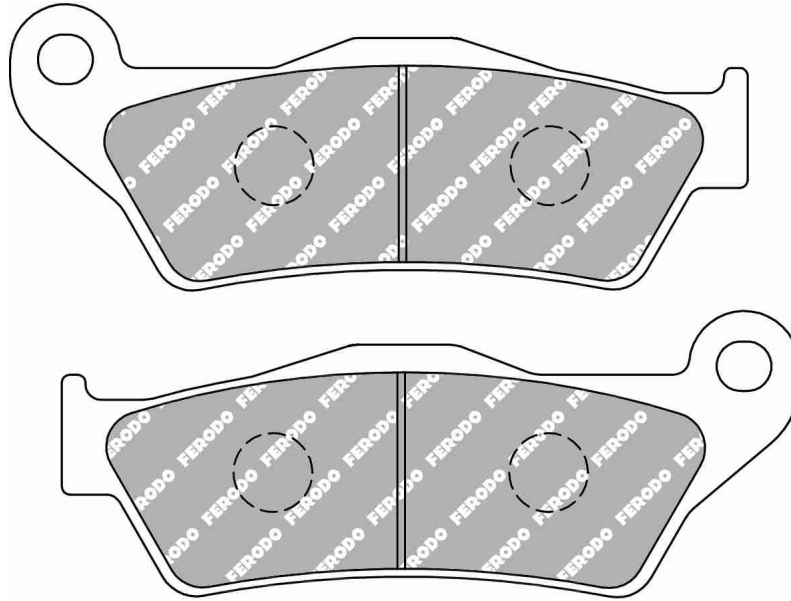

MATERIAL AVAILABILITY											
AG	EF	P	PRP	ST	SM	SG	ZR	XRAC	ZRAC	CP1	CPR0
	✓	✓		✓		✓	✓				



ALSO AVAILABLE		
SHAPE	TH. MM	NOTES
FDB2039	8.6 / 10.1	

CROSS REFERENCE	
BRAKING	746
BREMBO	07BB04
BREMBO	07HD21
BREMBO	7001
BRENTA	3027
BRENTA	4027
BRENTA	4168
CL BRAKES	2352
EBC	FA181
EBC	FA245
EBC	FA643
GALFER	FD138
GOLD FREN	031
LUCAS/TRW	MCB648
NEWFREN	FD0186
SBS	151
SBS	671
VESRAH	VD-947

		CC	KW	FROM	TO	FRONT REAR	LEFT RIGHT
	ALFER	M	AR 250	250	1993	F	
		M	NO LIMITS 250	250	1995	F	
		M	VR 250	250	1994	F	
		M	VR 250 ENDURO	250	1995	F	
		M	VR 250 MOTOCROSS	250	1995	F	
		M	VR 250 SUPERMOTARD	250	1999	F	
	APRILIA	M	MX 125	125	2004	2006	F
		M	RX 125	125	1995	2002	F
		M	RX 125 (AJP Caliper F&R)	125	2008	2013	F
		M	RX 125 (Brembo Front & Grimeca Rear)	125	2008	2013	F

		CC	KW	FROM	TO	FRONT REAR	LEFT RIGHT
		M	SX 125	125	2008	2017	F
		S	SRV 850 ABS ATC	850	2013		F
		M	RST FUTURA 1000	1000	2001		R
		ATK (USA)	M	all models 1996-01		1996	2001
	BAJAJ	M	Discover 125 ST	124	10	2012	F
		M	Discover 125 T	124	10	2013	F
		M	Discover 125 M	124	9	2014	F
		M	Discover 125	125		2005	F
		M	Discover 125	125	8	2016	F
		M	Discover 135	134	10	2008	F

M = MOTORCYCLE
S = SCOOTER
A = ATV
Sn = SNOWMOBILE



		CC	KW	FROM	TO	FRONT REAR	LEFT RIGHT
M	Discover 135 DTS-i	134	9	2010		F	
M	Pulsar 135 DTSi	134	10	2010		F	
M	Pulsar 135 LS	134	10	2011		F	
M	Discover 135	135		2004		F	
M	Pulsar 150 Classic	143	9	2001		F	
M	Discover 150	144	10	2010		F	
M	Discover 150 F	144	15	2016		F	
M	Discover 150 S	144	15	2016		F	
M	Pulsar 150 DTSi UG1	149	10	2003		F	
M	Pulsar 150 DTSi UG2	149	10	2005		F	
M	Pulsar 150 DTSi UG3	149	10	2006		F	
M	Pulsar 150 DTSi UG4	149	11	2006		F	
M	Pulsar 150	149	11	2011		F	
M	Pulsar 150	150		2001		F	
M	Pulsar 150 AS	150	12	2011		F	
M	Eliminator	174	11	2001		F	
M	Pulsar 180 Classic	178	11	2001		F	
M	Pulsar 180 DTSi UG1	178	12	2003		F	
M	Pulsar 180 DTSi UG2	178	12	2005		F	
M	Pulsar 180 DTSi UG3	178	12	2006		F	
M	Pulsar 180 DTSi UG4	178	12	2009		F	
M	Pulsar 180	178	12	2011		F	
M	Avenger 180	180		2005	2007	F	
M	Eliminator 180	180		2001		F	
M	Pulsar 180	180		2001		F	
M	Pulsar 200 DTSi	198	13	2006		F	
M	Pulsar 200 DTSi	198	13	2007		F	
M	Pulsar 200 AS	199	18	2011		F	
M	Pulsar 200 NS	199	18	2011		F	
M	Pulsar 200 NS	200		2009		F	
M	Pulsar 220 DTS Fi	220	15	2006		F	
M	Pulsar 220	220		2007	2009	F	
M	Pulsar 220 S DTSi	220	15	2010		F	
M	Pulsar 220 DTS Fi	220	15	2011		F	
M	Pulsar 220 F	220	15	2011		F	
BENELLI	M BX Motard (250cc)	250		2012		F	
M	BX Cross (449cc)	449		2007	2012	F	
M	BX Enduro (505cc)	505		2008	2012	F	
BIMOTA	M DBX	1078		2013		R	
BMW	M G450 X	450		2008		F	
M	R nineT (R1ST)	1170	81	2014		R	
M	R nineT (R1ST)	1170	79	2014		R	
M	R nineT Scrambler	1170		2016		R	
M	R nineT Pure	1170		2017		R	
M	R nineT Racer	1170		2017		R	
M	R NineT Urban G/S	1170		2017		R	
CAGIVA	M ELEFANT 750	750		1994		R	
CCM	M 604 E 600 SPORT	600		1999		F	
M	604 E 600 SUPERMOTO	600		1999		F	
M	C 25 600	600		1996		F	
M	604 RS ROADSTER	604		2000		F	
DERBI	M GP800	800		2010	2010	F	
M	GP800	800		2011		F	
DUCATI	M MULTISTRADA DARK 620	620		2003	2005	F	
M	MULTISTRADA 620 (twin disc)	620		2005	2006	F	
M	MONSTER 695	695		2006	2008	F	
M	MONSTER S2R 800	800		2007		F	
M	Multistrada 950	937	83	2017		R	
M	Multistrada 950 S	937	83	2019		R	
M	MULTISTRADA 1200S	1198		2015		R	
M	MULTISTRADA 1200S D air	1198		2015		R	
M	MULTISTRADA 1200 ENDURO	1198	112	2016		R	
M	MULTISTRADA 1200 Pikes peak	1198		2016		R	
M	Multistrada 1260	1262	116	2018		R	
M	Multistrada 1260 Pikes peak	1262	116	2018		R	
M	Multistrada 1260 S	1262	116	2018		R	
M	Multistrada 1260 S D air	1262	116	2018		R	
M	Multistrada 1260 Enduro	1262	116	2019		R	
M	Multistrada 1260 S Grantour	1262	116	2020		R	left
GASGAS	M ENDURCROSS 80	80		1994		F	
M	CROSS 125	125		1994		F	
M	EC / MC 125	125		1996	1999	F	
M	ENDURCROSS 125	125		1994		F	
M	TT 125 ENDURCROSS	125		1993		F	
M	TT 125	125		1995		F	
M	CROSS 250	250		1995		F	
M	EC / MC 250	250		1996	1999	F	
M	ENDURCROSS 250	250		1995		F	
M	TT 250	250		1995		F	
M	EC / MC 300	300		1996	1999	F	



		CC	KW	FROM	TO	FRONT REAR	LEFT RIGHT
GASGAS ATV	A WILD HP 50	50		2002	2005	F	
A	WILD HP 50	50		2002	2005	R	
A	HP 125	125		2007	2008	F	
A	HP 125	125		2007	2008	R	
A	HP 200	200		2008		F	
A	HP 200	200		2008		R	
A	WILD HP 240	240		2002	2005	F	
A	WILD HP 240	240		2002	2005	R	
A	WILD HP 250	250		2008		F	
A	WILD HP 250	250		2008		R	
A	HP 300 RV	300		2006		F	
A	HP 300 RV	300		2006		R	
A	WILD HP 300	300		2002	2005	F	
A	WILD HP 300	300		2002	2005	R	
A	WILD HP 450	450		2002	2008	F	
A	WILD HP 450	450		2002	2008	R	
A	WILD HP 515	515		2009		F	
A	WILD HP 515	515		2009		R	
GILERA	M NEXUS 500	500		2004		F	
M	GP800	800		2008		F	
HARLEY DAVIDSON	M XG 500 Street	549		2014		F	
M	XG 500 Street	549		2014		R	
M	XG 750A Street Rod	749		2018		R	
M	XG 750 Street	749		2014	2015	F	
M	XG 750 Street	749		2014	2015	R	
M	XG 750 Street	749		2016		R	
HUSABERG	M FE 350 / 450 / 550 / 650 / E	350		1995		F	
M	FC 400	400		1999		F	
M	FE 400 S - E	400		1998		F	
M	FE 450	450		2003	2006	F	
M	500 all models	500		1993	1995	F	
M	500 all models	500		1996		F	
M	FC 501	500		1998		F	
M	FE 501 S - E	500		1998		F	
M	FC 350 / 450 / 550	550		1995		F	
M	FE 550 E Strada	550		2008		F	
M	FE 570	570		2009		F	
M	FC 600 SUPERMOTARD	600		1998		F	
M	FE 600 S - E - R	600		1998		F	
M	FE 650 E	650		2006	2008	F	
HUSQVARNA	M 125 ALL MODELS 1994-1995	125		1994	1995	F	
M	CR 125	125		1996	2004	F	
M	CR 125	125		2005	2013	F	
M	SM 125 S SUPERMOTARD	125		1998	1999	F	
M	SM 125 S	125		2002	2011	F	
M	SM 125 S (4T)	125		2011		F	
M	TC 125 (2T)	125		2014		F	
M	TE 125	125		2007	2010	F	
M	TE 125 (4T)	125		2011	2013	F	
M	TE 125 (2T)	125		2014		F	
M	TX 125	125		2018		F	
M	WR 125	125		1998	2005	F	
M	WR 125	125		2006	2013	F	
M	ENDURO WR 125	125		2010		F	
M	WRE 125 / DUAL	125		1994	1999	F	
M	WRE 125	125		2000	2013	F	
M	250 ALL MODELS 1994-1995	250		1994	1995	F	
M	CR 250	250		1996		F	
M	CR 250	250		2005	2007	F	
M	FC 250 (4T)	250		2014		F	
M	FE 250 (4T)	250		2014		F	
M	SMS 250	250		2011		F	
M	TC 250	250		2002	2003	F	
M	TC 250	250		2005	2008	F	
M	TC 250 (4T)	250		2009	2013	F	
M	TC 250 R	250		2013		F	
M	TC 250 (2T)	250		2014		F	
M	TE 250 (4T)	250		2002	2005	F	
M	TE 250 (4T)	250		2006	2013	F	
M	TE 250 Meo Replica (4T)	250		2011	2011	F	
M	TE 250 R (4T)	250		2013		F	
M	TE 250 (2T)	250		2014		F	
M	WR 250	250		1995	2008	F	
M	WR 250 (2T)	250		2009	2013	F	
M	TE 300 (2T)	300		2014		F	
M	WR 300 (2T)	300		2009	2013	F	
M	TE 310	310		2010	2013	F	
M	TE 310 R (4T)	310		2013		F	
M	FC 350 (4T)	350		2014		F	
M	FE 350 (4T)	350		2015		F	



		CC	KW	FROM	TO	FRONT / REAR	LEFT / RIGHT
	M TE 350	350		1996		F	
	M WR 360 ENDURO	360		1998	1999	F	
	M TE 400 E DUAL - ENDURO	400		1998		F	
	M TE 410 E	410		2000		F	
	M TC 449	449		2011	2013	F	
	M TE 449	449		2011	2013	F	
	M FC 450 (4T)	450		2014		F	
	M FE 450 (4T)	450		2014		F	
	M TC 450	450		2003	2004	F	
	M TC 450	450		2005	2010	F	
	M TE 450	450		2003	2005	F	
	M TE 450	450		2006	2008	F	
	M TE 450 (4T)	450		2009	2010	F	
	M FE 501 (4T)	501		2014		F	
	M TC 510	510		2004	2004	F	
	M TC 510	510		2005	2009	F	
	M TE 510	510		2002	2005	F	
	M TE 510	510		2006	2010	F	
	M TE 511 (4T)	511		2011	2012	F	
	M TE 570	570			2004	F	
	M LT 600 DUAL	600		1998		R	
	M TE 600	600		1996		F	
	M TE 600 E DUAL - ENDURO	600		1998		F	
	M TC 610	610		1996		F	
	M TE 610 E	610		1995	2000	F	
	M TE 610 E	610		2003	2004	F	
	M TE 610/IE	610		2006	2009	F	
	M TE 630	630		2010	2012	F	
KEEWAY	S Silverblade 125/150/250	125			2007	F	
	M KXM 200	200		2014		F	
	M KXV 200	200		2014		F	
KTM	M 125 all models	125		1992	1993	F	
	M 125 all models	125		1992	1993	R	
	M 125 EXC (2T)	125		1998	2003	F	
	M 125 EXC (2T)	125		2004		F	
	M 125 EXC Six Days (2T)	125		2011		F	
	M EXE 125	125		2000	2003	F	
	M LC2 125	125		1998		F	
	M SX 125	125		1996	2002	F	
	M SX 125	125		2003		F	
	M 125 XC-W (2T)	125		2018		F	
	M SX 150	150		2008		F	
	M EGS 200	200		1998		F	
	M 200 EXC (2T)	200		1998	2003	F	
	M 200 EXC (2T)	200		2004		F	
	M SX 200	200		2003		F	
	M 250 all models	250		1992	1993	F	
	M 250 all models	250		1992	1993	R	
	M 250 all models	250		1994	1995	F	
	M 250 EXC (2T)	250		1998	2003	F	
	M 250 EXC (2T)	250		2004		F	
	M 250 EXC-F (4T)	250		2007		F	
	M 250 EXC Six Days (2T)	250		2011		F	
	M 250 EXC-F Six Days (4T)	250		2011		F	
	M MX 250	250		2003		F	
	M Superenduro 250 - S	250		2008		F	
	M Superenduro 250 - S	250		2008		R	
	M SX 250 (2T)	250		1994	2002	F	
	M SX 250 (2T)	250		2003		F	
	M SX-F 250 (4T)	250		2006		F	
	M 300 all models	300		1994	1995	F	
	M 300 EXC (2T)	300		2000	2003	F	
	M 300 EXC (2T)	300		2004		F	
	M 300 EXC Six Days (2T)	300		2011		F	
	M MX 300	300		2004		F	
	M 350 EXC-F (4T)	350		2011		F	
	M 350 EXC-F Six Days (4T)	350		2012		F	
	M GS 350 4 STROKE	350		1993		F	
	M SX-F 350	350		2011		F	
	M 350 XC-F	350		2011		F	
	M 350 XCF W	350		2011		F	
	M SX 380	380		1998		F	
	M EXC 400	400		2006		F	
	M LC4 400 E	400		1998		F	
	M SXC 400	400		1998		F	
	M SX 400	400		2000		F	
	M 450 EXC (4T)	450		2003	2004	F	
	M 450 EXC (4T)	450		2004		F	
	M 450 EXC Six Days (4T)	450		2011		F	
	M MXC 450	450		2003		F	



		CC	KW	FROM	TO	FRONT / REAR	LEFT / RIGHT
	M SX 450 / F	450		2003		F	
	M SX-F 450	450		2007		F	
	M 500 all models	500		1993	1993	F	
	M 500 all models	500		1993	1993	R	
	M 500 all models	500		1994	1995	F	
	M 500 EXC (4T)	500		1998	2011	F	
	M 500 EXC (4T)	500		2012		F	
	M 500 EXC Six Days (4T)	500		2012		F	
	M 500 XC-W	500		2012		F	
	M SX / MX 525	525		2003		F	
	M SXC 540	540		1998		F	
	M MX 600	600		1992		F	
	M SC 600	600		1998		F	
	M ADVENTURE 620 / 625 / 640 R	620		1998		F	
	M LC4 620 COMPETITION	620		1998		F	
	M DUKE 2 640	640		1998	1999	F	
	M LC4 640 SUPERMOTO	640		1998		F	
	M LC4 640 E	640		1998		F	
	M SXC 650	650		2004		F	
	M 790 Adventure R Rally	799		2020		R	right
	M 790 Adventure	799	70	2019		R	
	M 790 Adventure R	799	70	2019		R	
	M ADVENTURE 950	950		2003		R	
	M 950 R SUPERENDURO	950		2006	2008	R	
	M SUPERMOTO 950	950		2005		R	
	M 990 ADVENTURE ABS	990		2008		R	
	M 990 ADVENTURE R	990		2008		R	
	M 990 SMR	990		2008	2009	R	
	M 990 SMT	990		2009		R	
	M 990 SMR	990		2010		R	
	M 1050 ADVENTURE (ABS Std)	1050		2015		R	
	M 1090 ADVENTURE	1050	92	2017		R	
	M 1090 ADVENTURE R	1050	92	2017		R	
	M 1190 ADVENTURE (ABS Std)	1190		2013		R	
	M 1190 ADVENTURE R (ABS Std)	1190		2013		R	
	M 1290 SUPER ADVENTURE	1300		2015		R	
	M 1290 SUPER ADVENTURE R	1300	118	2017		R	
	M 1290 SUPER ADVENTURE T	1300		2017		R	
	M 1290 SUPER ADVENTURE S	1300	118	2017		R	
MAICO	M 250 CROSS	250		1998		F	
	M 500 CROSS	500		1998		F	
MBK	M DOODO 125	125		2001	2003	F	
	M SKYLINER 01 - 125	125		1998	2000	F	
	M SKYLINER 125 / S.E.	125		2001		F	
	M THUNDER 125	125		2001		F	
	M DOODO 150	150		2001	2003	F	
	M SKYLINER 150	150		2000	2002	F	
	M THUNDER 150	150		2001	2002	F	
	M SKYLINER 180	180		2004		F	
	M KILIBRE 300	300		2003		F	
	M KILIBRE 300	300		2003		R	
MOTO GUZZI	M BREVA V 850	850		2007		R	
	M GRISO 850	850		2007		R	
	M 940 - Bellagio	940		2007	2012	R	
	M BREVA V 1100 (Std/ABS Models)	1100		2005	2007	R	
	M GRISO 1100	1100		2005	2008	R	
	M QUOTA 1100 ES	1100		1999	2001	R	
	M BREVA 1200	1200		2008	2009	R	
	M BREVA 1200 SPORT	1200		2008	2013	R	
	M GRANFERRO 1200	1200		2010		R	
	M GRAN PASSO 1200 / H83	1200		2010		R	
	M GRISO SE 1200 8V	1200		2007	2013	R	
	M NORGE 1200	1200		2006	2008	R	
	M NORGE 1200 GT 8V ABS	1200		2010		R	
	M SCRAMBLER 1200	1200		2010		R	
	M STELVIO 1200	1200		2008	2011	R	
	M STELVIO 1200 NTX ABS	1200		2009	2010	R	
	M STELVIO 1200 8V NTX	1200		2011		R	
	M STELVIO 1200 8V ABS	1200		2011		R	
	M V12 LM	1200		2010		R	
MOTO MORINI	M Granpasso 1200 / H83	1200		2008		R	
	M Scrambler 1200	1200		2008		R	
PIAGGIO	S Beverly 400 i.e.	400		2007	2007	F	
	S X9 500	500		2003		F	
	S X9 500 ie	500		2007		F	
RIEJU	M MARATHON 250	250		2010		F	
	M MARATHON 450	450		2010		F	
SHERCO	M SE-R 125i	125		2017		F	
	M Enduro 2.5i (4T) Inc. SE Models	250		2008	2011	F	
	M SE250 i (2T/Brembo Rear Caliper)	250		2012		F	

M = MOTORCYCLE
S = SCOOTER
A = ATV
Sn = SNOWMOBILE



		CC	KW	FROM	TO	FRONT / REAR	LEFT / RIGHT
M	SE-R 250 (2T)	250		2012		F	
M	SEF 250 (4T)	250		2013		F	
M	SEF-R 250 (4T)	250		2013		F	
M	SM 2.5i Supermotard (4T)	250		2008		F	
M	SX 2.5i F Moto Cross	250		2010		F	
M	Enduro SE 3.0i (4T)	300		2010	2011	F	
M	SE300 i (2T/Brembo Rear Caliper)	300		2012		F	
M	SE-R 300 (2T)	300		2012		F	
M	SEF 300 (4T)	300		2013		F	
M	SEF-R 300 (4T)	300		2013		F	
M	Enduro 4.5i (4T) Inc SE Models	450		2004	2011	F	
M	SE 450 i R (Nissin Rear Caliper)	450		2012	2013	F	
M	SEF-R 450	450		2015		F	
M	SM 4.5i F (Supermotard)	450		2004	2010	F	
M	Enduro 5.1iF Inc SE Models	510		2007	2011	F	
M	SE 510 i R (Nissin Rear Caliper)	510		2012	2013	F	
M	SM 5.1i F Supermotard	510		2007		F	
SUZUKI	S UH 150 BURGMAN (BR11)	150	11	2002	2006	F	
SWM	M RS 300 R (4T)	300		2015		F	
M	RS 500 R	500		2015		F	
TM	M 80 (Big wheel)	80		2002	2004	F	
M	80 Cross	80		1996	2001	F	
M	80 Enduro	80		1996	2000	F	
M	80 Junior Cross (Small wheel)	80		2002	2004	F	
M	80 Junior	80		2005	2007	F	
M	85 (Big wheel)	85		2002	2004	F	
M	85 Cross	85		1996	2001	F	
M	85 Junior Cross (Small wheel)	85		2002	2004	F	
M	85 Junior	85		2005	2007	F	
M	MX 85 (Big Wheel)	85		2002	2004	F	
M	MX 85 JR (Small Wheel)	85		2002	2004	F	
M	MX 85 (Big Wheel)	85		2005		F	
M	MX 85 JR (Small Wheel)	85		2005		F	
M	100 (Big wheel)	100		2002	2004	F	
M	100 Junior Cross (Small wheel)	100		2002	2004	F	
M	100 Junior	100		2005	2007	F	
M	125 Cross	125		1995	2000	F	
M	Enduro EN 125 (2T)	125		2001	2004	F	
M	Enduro EN 125 (2T) - USA VERSION	125		2005	2008	F	
M	Enduro EN 125 (2T)	125		2005		F	
M	125 Enduro	125		1995	2000	F	
M	MX 125 (2T)	125			2004	F	
M	MX 125 (2T)	125		2005		F	
M	EN 144 (2T)	144		2008		F	
M	MX 144 (2T)	144		2008		F	
M	250 Cross	250		1995	2000	F	
M	Enduro EN 250 (2T)	250		2001	2004	F	
M	Enduro EN 250 (2T)	250		2005		F	
M	EN 250 Fi (4T) Enduro	250		2005		F	
M	EN 250 Fi ES	250		2015		F	
M	250 Enduro	250		1995	2000	F	
M	MX 250 (2T)	250		2001	2004	F	
M	MX 250 (4T) Cross	250		2002	2004	F	



		CC	KW	FROM	TO	FRONT / REAR	LEFT / RIGHT
M	MX 250 (4T) Cross	250		2005	2012	F	
M	MX 250 (2T)	250		2005		F	
M	MX 250 Fi (4T)	250		2010		F	
M	300 Cross	300		1995	2000	F	
M	Enduro EN 300 (2T)	300		2001	2004	F	
M	Enduro EN 300 (2T)	300		2005		F	
M	EN 300 Fi (4T)	300		2017		F	
M	300 Enduro (2T)	300		1995	2000	F	
M	MX 300 (2T)	300		2001	2004	F	
M	MX 300 (2T)	300		2005		F	
M	MX 300 Fi (4T)	300		2017		F	
M	400 Cross (4T)	400		1995	2000	F	
M	400 (4T) MX Cross	400		2002	2003	F	
M	EN 450 F (4T)	450			2004	F	
M	EN 450 Fi (4T)	450		2005		F	
M	EN 450 Fi ES	450		2015		F	
M	FLAT TRACK 450 Fi	450		2016		F	
M	MX 450 F (4T)	450			2004	F	
M	MX 450 F - USA versiom	450		2005	2008	F	
M	MX 450 Fi (4T)	450		2005		F	
M	530 Cross (4T)	530		1998	2000	F	
M	EN 530 F (4T)	530			2004	F	
M	EN 530 Fi (4T)	530		2005		F	
M	MX 530 F	530			2004	F	
M	MX 530 F	530		2005		F	
M	MX 530 Fi (4T)	530		2016		F	
TRIUMPH	M TIGER 800 XRx Low	800		2018		F	
M	TIGER 800 Xca	800		2018		F	
M	TIGER 800 XCx (A082)	800	70	2018		F	
M	TIGER 800 XRT	800		2018		F	
YAMAHA	M Enticer	125		2002	2005	F	
M	Fazer	125		2004	2006	F	
M	MAXTER 125	125		2001	2003	F	
M	XQ 125 N MAXSTER	125		2001	2003	F	
M	YP 125 MAJESTY (SE02)	125		1998	2000	F	
M	YP 125 MAJESTY (SE06)	125		2001	2009	F	
M	YZF-R 125	125		2008	2013	F	
M	Fazer	150		2009		F	
M	FZ1	150		2009		F	
M	YP 150 MAJESTY	150		2001	2003	F	
M	FZ 25	249		2018		F	
M	VERSITY 300	300		2004		F	
M	VERSITY 300	300		2004		R	
M	TT 600	600		1993		F	
M	TT 600 R (SPORTKIT)	600		1994	1997	F	
M	TT 600 R	600		1998	1999	F	
M	TT 600 RE	600		2004		F	
M	TT-R 600 R	600		2000	2003	F	
M	XT 660 Z TENERE (Non ABS)	660		2008		F	
M	XT 660 ZA TENERE (ABS)	660		2011	2011	F	
M	Tenere 700	689	54	2019		F	
M	Tenere' 700 World Raid Proto	689		2018		F	

FDB2033

69.6 x 52.0 x 8.0 mm

MATERIAL AVAILABILITY											
AG	EF	P	PRP	ST	SM	SG	ZR	XRAC	ZRAC	CP1	CPRO
		✓									

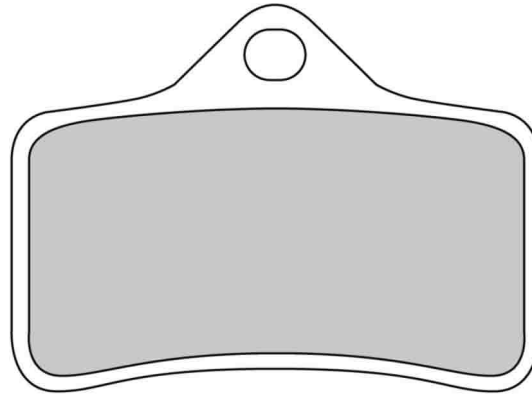

Pinze / Calipers

Spiegler

4-Piston

CROSS REFERENCE	
CL BRAKES	2920
EBC	FA361

FDB2036

91.6 x 51.5 x 8.5 mm

MATERIAL AVAILABILITY											
AG	EF	P	PRP	ST	SM	SG	ZR	XRAC	ZRAC	CP1	CPRO
		✓		✓				⚠			

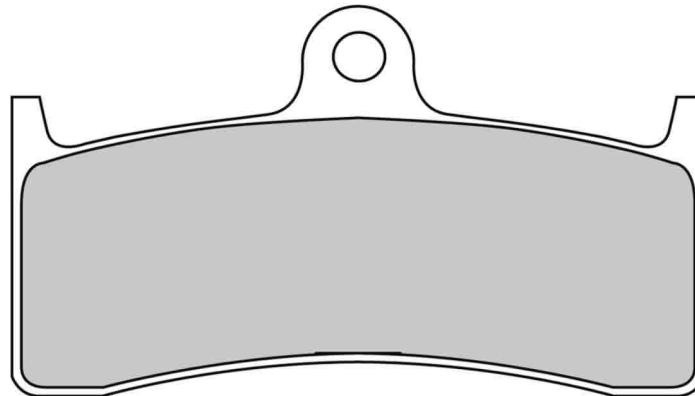

Pinze / Calipers

AMERICAN IRONHORSE

American Ironhorse 6 Pot

BERINGER

6 Piston

Hawg Halters

6 Pot

Nissin

Nissin 6 Piston Racing

Performance Machine

112x6 6-Piston

CROSS REFERENCE	
BRAKING	801
BREMBO	07KA20
CL BRAKES	2404
CL BRAKES	2899
EBC	FA249
EBC	FA424
GALFER	FD193
GALFER	FD246
GALFER	FD393
GOLD FREN	126
LUCAS/TRW	MCB660
NEWFREN	FD0246
SBS	676
SBS	729
VESRAH	VD-437

		CC	KW	FROM	TO	FRONT / REAR	LEFT / RIGHT
	BUPELL	M		1998	2002	F	
		M		1998	2002	F	
		M		1998	2002	F	
		M		2000	2005	F	
		M	1200	1998	2002	F	
	M	1200		2000	2005	F	

		CC	KW	FROM	TO	FRONT / REAR	LEFT / RIGHT	
	HONDA	M		1300		1998	2000	F
	KAWASAKI	M		750		1996	1999	F
		M		1100		1996	2000	F
	MV AGUSTA	M		750		2003	2005	F
		M		910		2007		F
		M		998		2004	2006	F

FDB2037

31.6 x 49.0 x 7.0 mm

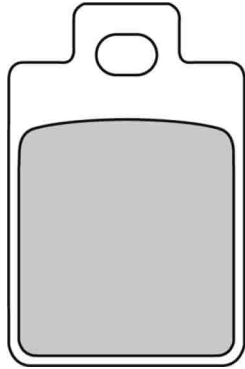

MATERIAL AVAILABILITY											
AG	EF	P	PRP	ST	SM	SG	ZR	XRAC	ZRAC	CP1	CPR0
✓											

CROSS REFERENCE	
BRAKING	805
BREMBO	07017
BREMBO	7017
EBC	FA255
EBC	SFA255
GALFER	FD197
LUCAS/TRW	MCB688
NEWFREN	FD0225
SBS	712
VESRAH	VD-955

		CC	KW	FROM	TO	FRONT / REAR	LEFT / RIGHT	
	PIAGGIO	M		50		1995	1997	F

		CC	KW	FROM	TO	FRONT / REAR	LEFT / RIGHT	
	M			125		1995	1997	F

FDB2039

94.0 x 37.0 x 8.6 mm / 94.0 x 37.0 x 10.1 mm

Pad does not allow fitment of wear indicators for K1200 GT and K1300 GT 2008-> models

MATERIAL AVAILABILITY											
AG	EF	P	PRP	ST	SM	SG	ZR	XRAC	ZRAC	CP1	CPRO
	✓	✓		✓							

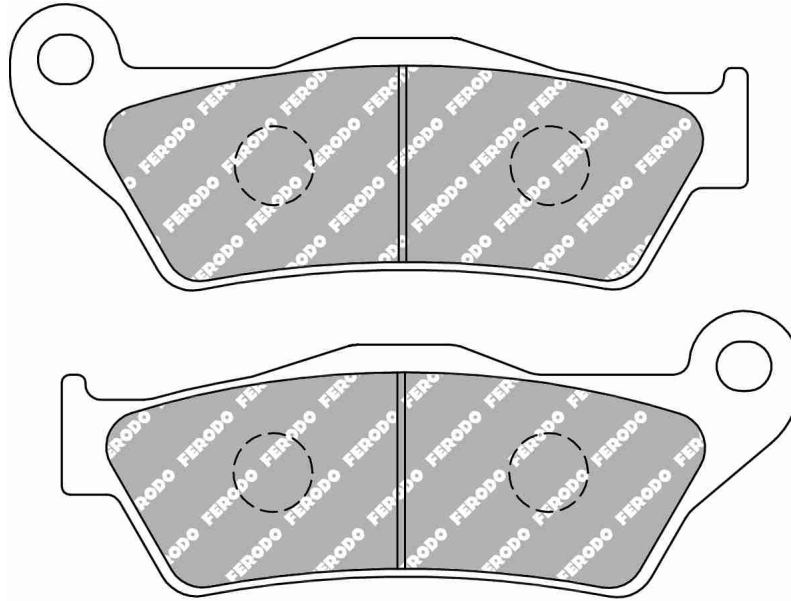

ALSO AVAILABLE		
SHAPE	TH. MM	NOTES
FDB2018	7.7	

CROSS REFERENCE	
BRAKING	794
BREMBO	07BB04
BRENTA	3084
BRENTA	4084
CL BRAKES	2900
EBC	FA363
EBC	FA438
EBC	FA671
GALFER	FD186
GOLD FREN	292
LUCAS/TRW	MCB707
NEWFREN	FD0229
SBS	742
VESRAH	VD-947
VESRAH	VD-947/2
VESRAH	VD-947/3

		CC	KW	FROM	TO	FRONT REAR	LEFT RIGHT
	BMW	M	R	850	1995	2000	R
		M	R	850	1999	2000	R
		M	R	850	1999	2000	R
		M	R	850	2001		R
		M	R	850	2002	2003	R
		M	S	1000	121	2020	R
		M	S	1000	118	2015	R
		M	R	1100	1994	1999	R
		M	R	1100	1995	2001	R
		M	R	1100	1995	2000	R
		M	R	1100	2001		R
		M	R	1100	2001		R

		CC	KW	FROM	TO	FRONT REAR	LEFT RIGHT
	M	R	1150	1998	2001	R	
	M	R	1150	2001		R	
	M	R	1150	2001		R	
	M	R	1150	2001		R	
	M	R	1150	2001		R	
	M	R	1150	2002		R	
	M	R	1150	2003		R	
	M	HP2	1200	2004	2006	R	
	M	HP2	1200	2008		R	
	M	HP2	1200	2008		R	
	M	K	1200	2004		R	

M = MOTORCYCLE
S = SCOOTER
A = ATV
Sn = SNOWMOBILE

		CC	KW	FROM	TO	FRONT / REAR	LEFT / RIGHT
	M K 1200 GT	1200		2007		R	
	M K 1200 RT	1200		2008		R	
	M R 1200 C (259C)	1200		1997	2000	R	
	M R 1200 C CLASSIC	1200		2003		R	
	M R 1200 C MONTAUK	1200		2004		R	
	M R 1200 ST	1200		2005	2007	R	
	M R 1200 RT (K26)	1200	79	2006	2013	R	
	M R 1200 S	1200		2006	2008	R	
	M R 1200 R (R1ST)	1200	80	2006		R	
	M R 1200 R (R1ST)	1200	79	2006		R	
	M R 1200 R (R1ST)	1200	72	2006		R	
	M R 1200 GS (R12)	1200	72	2004	2012	R	

		CC	KW	FROM	TO	FRONT / REAR	LEFT / RIGHT
	M R 1200 GS (R12)	1200	74	2004	2012	R	
	M R 1200 GS Adventure (R12)	1200	74	2004	2012	R	
	M R 1200 GS Adventure (K25)	1200	72	2006	2012	R	
	M R 1200 GS Adventure Triple Black (K25)	1200	81	2006	2012	R	
	M R 1200 GS Adventure (K25)	1200	77	2007	2009	R	
	M R 1200 GS (K25)	1200	77	2008	2009	R	
	M R 1200 GS (K25)	1200	81	2009	2012	R	
	M R 1200 GS Adventure (K25)	1200	81	2009	2012	R	
	M K 1300 GT	1300		2009		R	
	M K 1300 R	1300		2009		R	
	M K 1300 S	1300		2009		R	
	M K 1300 S Motorsport	1300		2015		R	

FDB2040

69.4 x 51.1 x 7.9 mm

MATERIAL AVAILABILITY

AG	EF	P	PRP	ST	SM	SG	ZR	XRAC	ZRAC	CP1	CPRO
		✓	✓	✓							

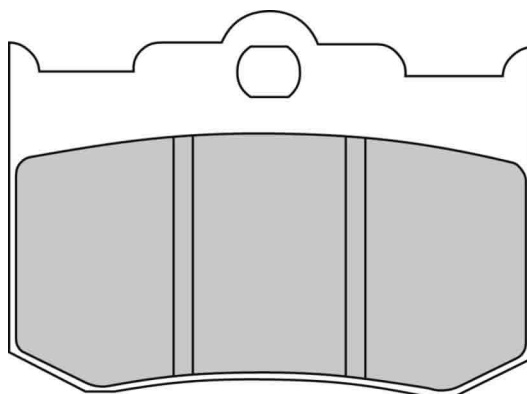

ALSO AVAILABLE

SHAPE	TH. MM	NOTES
FDB2041	11.0	

Pinze / Calipers

AMERICAN IRONHORSE

American Ironhorse PM caliper 4 pot

Hawg Halters

4 Pot

Legends/Nova

4-Piston

Performance Machine

125x4R 4-Piston; 8mm pad

Thunderheart

4-Piston

CROSS REFERENCE

EBC	FA216/3
LUCAS/TRW	MCB653
NEWFREN	FD0297
SBS	678
VESRAH	VD-944

		CC	KW	FROM	TO	FRONT / REAR	LEFT / RIGHT
	INDIAN			2002	2008	F	
	M Chief/Deluxe/Springfield/Roadmaster/Vintage			2002	2008	F	
	M Chief/Deluxe/Springfield/Roadmaster/Vintage			2002	2008	R	
	M Road Master/Vintage			2002	2008	F	
	M Road Master/Vintage			2002	2008	R	

		CC	KW	FROM	TO	FRONT / REAR	LEFT / RIGHT
				2002	2008	F	
	M Scout All models Scout/Deluxe/Springfield			2002	2008	F	
	M Scout All models Scout/Deluxe/Springfield			2002	2008	R	
	M Spirit All models Deluxe/Springfield/Roadblaster			2002	2008	F	
	M Spirit All models Deluxe/Springfield/Roadblaster			2002	2008	R	

4160

FERODO

RACING

Updated on November 2020

M = MOTORCYCLE
S = SCOOTER
A = ATV
Sn = SNOWMOBILE

FDB2041

69.4 x 51.1 x 11.0 mm

MATERIAL AVAILABILITY

AG	EF	P	PRP	ST	SM	SG	ZR	XRAC	ZRAC	CP1	CPRO
		✓									

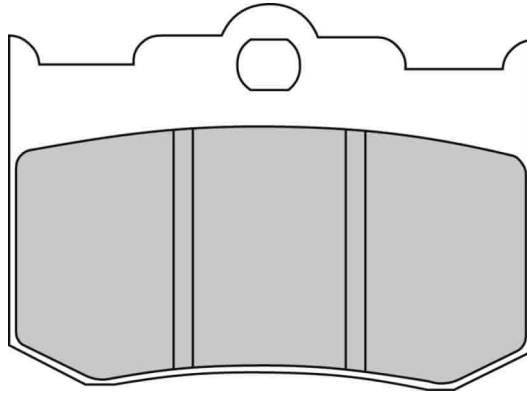

ALSO AVAILABLE

SHAPE	TH. MM	NOTES
FDB2040	7.9	

Pinze / Calipers

EBC

4 Piston

Performance Machine

137x4 4-Piston; 11mm pad

CROSS REFERENCE

EBC	FA216/2
NEWFREN	FD0299
SBS	662
VESRAH	VD-944/2

FDB2042

75.2 x 55.2 x 8.8 mm

MATERIAL AVAILABILITY											
AG	EF	P	PRP	ST	SM	SG	ZR	XRAC	ZRAC	CP1	CPRO
	✓	✓		✓				✓	✓	✗	✓

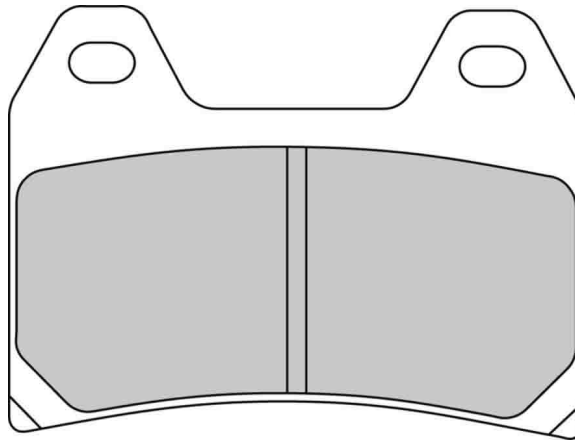

ALSO AVAILABLE		
SHAPE	TH. MM	NOTES
FDB2099	7.6	

Pinze / Calipers

BRAKING

Braking Systems 4 Pot; Twin Pin

BREMBO

220A01610

4-Piston Radial mount Billet HP w/ 108mm centers

4-Piston; Twin Pin Wide Mount 65mm

CROSS REFERENCE

BRAKING	784
BREMBO	07BB19
BREMBO	07HO47
BRENTA	3093
BRENTA	4093
CL BRAKES	2539
EBC	FA244
GALFER	FD176
GOLD FREN	141
LUCAS/TRW	MCB683
NEWFREN	FD0221
SBS	706
VESRAH	VD-262

		CC	KW	FROM	TO	FRONT / REAR	LEFT / RIGHT	
	APRILIA	M RS 250	250	1998		F		
		M PEGASO 650 STRADA	650	2004		F		
		M SMV 750 Dorsoduro FACTORY	750	2010		F		
		M RST FUTURA 1000	1000	2001		F		
		M RSV 1000 MILLE	1000	1997	2000	F		
		M RSV 1000 TUONO	1000	2004		F		
		M RSV 1000 MILLE R / SP	1000	2000	2000	F		
		M SL 1000 FALCO	1000	2000		F		
		M TUONO V4 R	1000	2011	2012	F		
		M TUONO V4 R APRC	1000	2011	2013	F		
		M DORSODURO 1200 / ABS / ATC	1200	2011		F		
		BENELLI	M 666 125	125	1998		F	
			M LEONCINO 500	500	2016		F	
		M TRK 502	500	2016		F		
		M 2 UE 750	750	2009	2010	F		
		M TNT 899	899	2007		F		
		M TNT 899 S	899	2007	2011	F		
		M TRE-K 899	899	2007	2014	F		
		M 900 TORNADO	900	2000		F		
		M TNT 1130 Cafe Racer	1130	2005	2005	F		
		M TNT 1130 Titanium	1130	2005	2005	F		
		M TRE-K 1130	1130	2006		F		
		M TRE-K 1130 Amazonas	1130	2007		F		
BIMOTA		M SB8K Gobert (Suzuki Engine) (996cc)	996		2006		F	

		CC	KW	FROM	TO	FRONT / REAR	LEFT / RIGHT
	BMW	M SB 8 1000 R	1000	1998		F	
		M G 650 X Moto	650	2008		F	
		M F800 GT	800	2013		F	
		M F800 S / ST / R	800	2007		F	
		M R nineT Scrambler	1170	2016		F	
		M R nineT Pure	1170	2017		F	
		M R nineT Racer	1170	2017		F	
		M R NineT Urban G/S	1170	2017		F	
	CAGIVA	M RAPTOR 650 / 650 i.e.	650	2001		F	
		M V RAPTOR 650	650	2001		F	
		M RAPTOR 1000	1000	2000		F	
		S RAPTOR V 1000	1000	2001		F	
		M RAPTOR XTRA 1000	1000	2003		F	
DUCATI	M 400 MONSTER (JAPAN)	400	2000		F		
	M M 600 MONSTER	600	2000	2000	F		
	M M 600 MONSTER	600	2001	2002	F		
	M M 620 MONSTER	620	2002	2003	F		
	M M 620 MONSTER DARK (single/twin disc)	620	2003		F		
	M MULTISTRADA 620 DARK (single disc)	620	2005	2006	F		
	M SPORT 620	620	2003		F		
	M MONSTER 696	696	2008	2013	F		
	M 748 BIPOSTO	748	1998		F		
	M 748 RACING CLIENTI	748	1998		F		
M 748 SPS	748	1998		F			



		CC	KW	FROM	TO	FRONT REAR	LEFT RIGHT
M	750 SUPERSPORT	750		1998	2002	F	
M	750 SPORT	750		2001	2002	F	
M	M 750 MONSTER	750		2000	2000	F	
M	M 750 MONSTER	750		2001	2002	F	
M	HYPERMOTARD 796	796		2010		F	
M	MONSTER 796 (ABS Std)	796		2011	2013	F	
M	800 SUPERSPORT	800		2003		F	
M	MONSTER 800	800		2003	2006	F	
M	848	848		2008		F	
M	Streetfighter 848	849		2014		F	
M	FE 900 SUPERSPORT	900		1998		F	
M	M 900 MONSTER I.E.	900		2000		F	
M	M 900 MONSTER	900		2001		F	
M	916 SUPERSPORT 4	916		1998		F	
M	916 STRADA	916		1998		F	
M	916 ST2	916		2001	2002	F	
M	M 916 MONSTER S4	916		2001	2002	F	
M	944 ST2	944		1997	2002	F	
M	M 944 SUPERSPORT 2	944		1998	2002	F	
M	944 ST4	944		1999		F	
M	ST3 992	992		2004		F	
M	996 SPS / S	996		1998		F	
M	996 BIPOSTO	996		1999		F	
M	ST4 / ST4 ABS 996	996		2001		F	
M	998 BIPOSTO	998		2002		F	
M	998 S	998		2002		F	
M	MONSTER 1000	1000		2003	2006	F	
M	MONSTER S2R 1000	1000		2007	2007	F	
M	MONSTER S2R 1000	1000		2008		F	
M	MONSTER S4R /S4RS 1000	1000		2008		F	
M	MULTISTRADA 1000 / 1000 DS / 1000S DS	1000		2003	2006	F	
M	SUPERSPORT 1000 DS	1000		2003		F	
M	HYPERMOTARD 1100	1100		2007		F	
M	HYPERMOTARD 1100 EVO	1100		2010		F	
M	MONSTER 1100 / 1100 S	1100		2009		F	
M	MULTISTRADA 1100 / 1100 S / S Touring / S Sport	1100		2007		F	
M	MULTISTRADA 1200S Touring (ABS Std)	1198		2010		F	
M	MULTISTRADA 1200S Pikes peak (ABS Std)	1198		2014		F	
M	MULTISTRADA 1200S Gran Turismo (ABS Std)	1198		2014		F	
M	MULTISTRADA 1200	1198	110	2014		F	
M	MULTISTRADA 1200	1198	112	2015		F	
M	MULTISTRADA 1200	1198	73	2015		F	
HONDA	CB 400 SUPER FOUR S	400		1997	1998	F	
HUSQVARNA	LT 600 DUAL	600		1998		F	
	SM 600 SUPERMOTARD	600		1998		F	
	LT 610	610		2000	2000	F	
	SM 610 (6 bolt front disc)	610		1998	1999	F	
	SM 610 R	610		2000	2011	F	
	SM 610/S (4 bolt front disc)	610		2002	2006	F	
	Svartpilen 701	701		2019		F	
	NUDA 900 R	900		2012		F	
	NUDA 900 R ABS	900		2013		F	
KTM	625 SMC LC4	625		2005		F	
	LC4 640 DUKE II	640		2000		F	
	LC4 660 SUPERMOTO	660		2003		F	
	660 SMC	660		2004		F	
	690 DUKE (ABS Std)	690	54	2012		F	
	690 SM	690		2007		F	
	Duke 790 Prototype	790		2017		F	
	790 Adventure R Rally	799		2020		F	
	790 Adventure	799	70	2019		F	
	790 Adventure R	799	70	2019		F	
	790 DUKE	799	77	2018		F	
	790 DUKE	799	77	2019		F	
	1050 ADVENTURE (ABS Std)	1050		2015		F	
	1090 ADVENTURE	1050	92	2017		F	
	1090 ADVENTURE R	1050	92	2017		F	
	1190 ADVENTURE (ABS Std)	1190		2013		F	
	1190 ADVENTURE R (ABS Std)	1190		2013		F	
	1290 SUPER ADVENTURE	1300		2015		F	
	1290 SUPER ADVENTURE R	1300	118	2017		F	
	1290 SUPER ADVENTURE T	1300		2017		F	
	1290 SUPER ADVENTURE S	1300	118	2017		F	
MOTO GUZZI	BREVA 750 IE	750		2003	2011	F	
	SP 750 NEVADA CLUB / CLASSIC I.E. / Aquila Nera	750		2002		F	
	V7 Classic	750		2008	2012	F	
	V7 Cafe Classic	750		2009	2012	F	
	V7 Racer	750		2010	2011	F	
	V7 II Racer	750		2012		F	
	V7 II Special	750		2012		F	



		CC	KW	FROM	TO	FRONT REAR	LEFT RIGHT
M	V7 II Stone	750	25	2012	2014	F	
M	V7 II Stone	750	37	2012		F	
M	V7 II Stornello	750		2016		F	
M	V7 III Anniversario	750		2017		F	
M	V7 III Racer	750		2017		F	
M	V7 III Special	750		2017		F	
M	V7 III Stone	750		2017		F	
M	BREVA V 850	850		2007		F	
M	GRISO 850	850		2007		F	
M	V9 Bobber	850		2016		F	
M	V9 Roamer	850		2016		F	
M	V85 TT	853	59	2020		F	
M	V9	900		2017		F	
M	V9 X-Track	900		2017		F	
M	LE MANS V 11	1064		2001		F	
M	BREVA V 1100	1100		2004		F	
M	BREVA V 1100 (Std/ABS Models)	1100		2005	2007	F	
M	CALIFORNIA (all models)	1100		2001	2006	F	
M	California 1100 Classic Touring	1100		2006	2008	F	
M	California 1100 Vintage	1100		2006	2012	F	
M	California 1100 Aquila Nera	1100		2009	2011	F	
M	California 1100 90	1100		2012	2012	F	
M	GRISO 1100	1100		2005	2008	F	
M	BREVA 1200	1200		2008	2009	F	
M	BREVA 1200 SPORT	1200		2008	2013	F	
M	CORSARO Avio / Veloce	1200		2010		F	
M	GRISO SE 1200 8V	1200		2007	2013	F	
M	1200 GT	1200		2010		F	
M	NORGE 1200	1200		2006	2008	F	
M	NORGE 1200 GT 8V ABS	1200		2010		F	
M	STELVIO 1200	1200		2008	2011	F	
M	STELVIO 1200 NTX ABS	1200		2009	2010	F	
M	STELVIO 1200 8V NTX	1200		2011		F	
M	STELVIO 1200 8V ABS	1200		2011		F	
M	Audace	1380		2016		F	
M	Audace Carbon	1380		2017		F	
M	California Touring SE	1380		2016		F	
M	Eldorado	1380		2016		F	
M	California 1400 Custom	1400		2013		F	
M	California 1400 Touring	1400		2013		F	
M	MGX-21 Flying fortress	1400		2016		F	
MOTO MORINI	9,5	1200		2006		F	
	Corsaro Veloce / Corsaro 1200 / Corsaro Avio	1200		2005		F	
	MM3	1200		2007		F	
	1200 SPORT	1200		2008		F	
MV AGUSTA	BRUTALE 675 (B3)	675		2012		F	
	F3 675	675		2012	2014	F	
	F3 675 CIV	675		2015		F	
	Brutale 800 RR America	798	103	2018		F	
	Brutale 800 RR Pirelli	798	103	2018		F	
	Dragster Rosso	798		2020		F	
	RVS#1 Lim.ed.	798	103	2018		F	
	BRUTALE 800 (B31)	800		2012		F	
	BRUTALE DRAGSTER 800 RR	800		2015		F	
	BRUTALE DRAGSTER 800	800		2015		F	
	BRUTALE 800 (B3)	800		2015		F	
	BRUTALE 800 RR (B3)	800		2015		F	
	BRUTALE DRAGSTER 800 RR LH44	800		2015		F	
	BRUTALE 800 (B11)	800		2016		F	
	BRUTALE DRAGSTER 800 RC	800	103	2017		F	
	BRUTALE 800 RC	800	81	2019		F	
	DRAGSTER 800 RC	800	103	2019		F	
	DRAGSTER 800 RR	800	103	2019		F	
	DRAGSTER 800 RR America	800	103	2019		F	
	DRAGSTER 800 RR LH44	800	103	2019		F	
	DRAGSTER 800 RR Pirelli	800	103	2019		F	
	SUPERVELOCE 800	800		2019		F	
	TURISMO VELOCE 800 Lusso SCS	800	81	2019		F	
	TURISMO VELOCE 800 RC SCS	800	81	2019		F	
	BRUTALE 920 (B53)	920		2011	2012	F	
	BRUTALE 989 R	989		2008	2009	F	
	BRUTALE 990 R	990		2010	2011	F	
	BRUTALE SERIE ORO 1000	1000	152	2019		F	
	BRUTALE 1090 R	1090		2012		F	
	BRUTALE 1090	1090		2013		F	
SCORPA	Raidster 660	660		2007		F	
SUZUKI	GSX 1200	1200		1999	2000	F	
TRIUMPH	THRUXTON 900 (Front Brembo caliper)	900		2008		F	
URAL	RETRO 750	750		2005		F	
VICTORY	Empulse TT			2016		F	

M = MOTORCYCLE
S = SCOOTER
A = ATV
Sn = SNOWMOBILE

	CC	KW	FROM	TO	FRONT		LEFT	
					REAR	RIGHT	REAR	RIGHT
M Hammer S				2007	F			
M Hammer			2005	2007	F			
M King Pin			2004	2007	F			
M King Pin Tour			2004	2007	F			
M Ness Signature Series			2005	2007	F			
M V92SC			2000	2003	F			

	CC	KW	FROM	TO	FRONT		LEFT	
					REAR	RIGHT	REAR	RIGHT
M Vegas			2003	2007	F			
M Vegas 8-Ball			2005	2007	F			
M Vegas Jackpot			2006	2007	F			
M V92C (All models single front rotor)	1500		1998	2003	F			
YAMAHA M XT 660 X Supermoto	660		2004		F			
M XJR 1200	1200		1995	1998	F			

FDB2048

133.6 x 36.5 x 8.4 mm / 109.2 x 44.0 x 8.4 mm

MATERIAL AVAILABILITY											
AG	EF	P	PRP	ST	SM	SG	ZR	XRAC	ZRAC	CP1	CPRO
	✓	✓		✓				✓		✓	

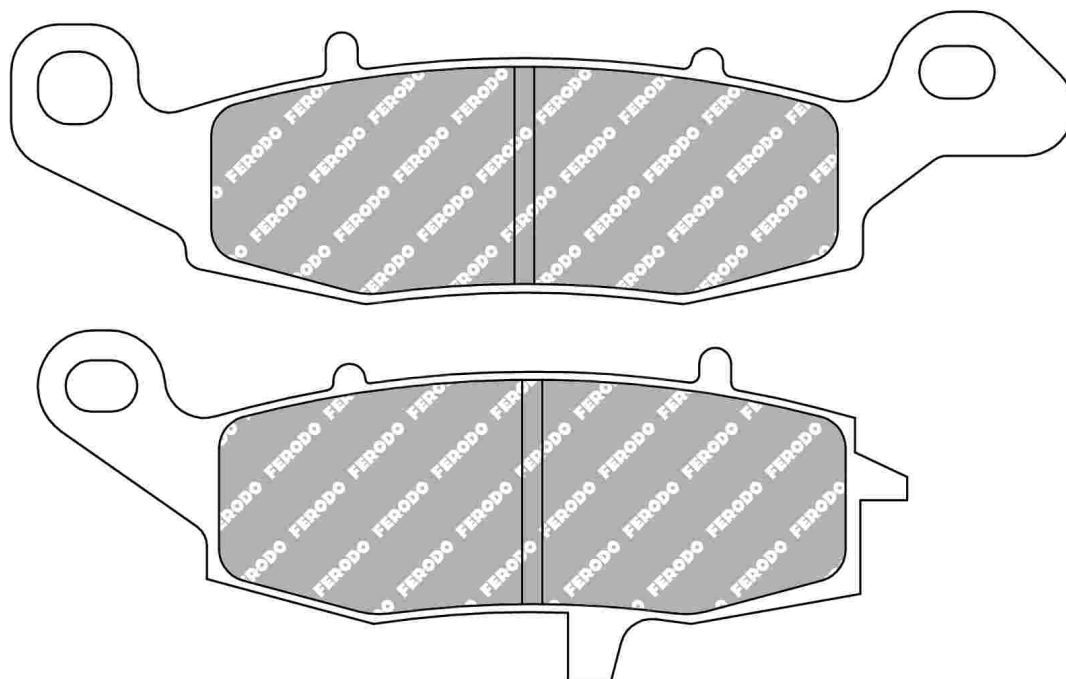

ALSO AVAILABLE		
SHAPE	TH. MM	NOTES
FDB2049		Coupled set

CROSS REFERENCE	
BRAKING	782
BREMBO	07KA19
BRENTA	3092
BRENTA	4092
CL BRAKES	2383
EBC	FA229
EBC	FA237
GALFER	FD174
GOLD FREN	104
LUCAS/TRW	MCB682
NEWFREN	FD0228
SBS	705
VESRAH	VD-352



		CC	KW	FROM	TO	FRONT / REAR	LEFT / RIGHT
CFMOTO	M 650NK	650		2012	2014	F	left
	M 650TK	650		2013	2014	F	left
	M 650TR	650		2013	2014	F	left
KAWASAKI	M VN 400 CLASSIC	400		1999		F	
	M ER-5 500 (ER)	500		2001		F	
	M ER-6 650 F	650		2005		F	left
	M ER-6 650 N (ER650A)	650	53	2005	2008	F	left
	M ER-6 650 N ABS (ER650A)	650	53	2005	2008	F	left
	M ER-6 650 N (ER650A)	650	25	2006	2008	F	left
	M ER-6 650 N (ER650C)	650	25	2009	2011	F	left
	M ER-6 650 N (ER650C)	650	53	2009	2011	F	left
	M ER-6 650 N ABS	650	53	2011	2011	F	left
	M ER-6 650 N (ER650E)	650	25	2012		F	left
	M ER-6 650 N (ER650E)	650	35	2012		F	left
	M ER-6 650 N (ER650E)	650	53	2012		F	left
	M ER-6 650 N ABS (ER650E)	650	25	2012		F	left
	M ER-6 650 N ABS (ER650E)	650	35	2012		F	left
	M ER-6 650 N ABS (ER650E)	650	53	2012		F	left
	M KLR 650	650		1995	2005	F	
	M Versys (LE650A)	650	53	2007	2009	F	left
	M Versys (LE650A)	650	47	2007	2009	F	left
	M Versys (LE650A)	650	25	2007	2009	F	left
	M Versys (LE650C)	650	47	2009	2013	F	left
	M Versys (LE650C)	650	25	2009	2013	F	left
	M Z 750 / Z 750 S	750		2004	2006	F	left
	M ZR 750 ZEPHYR	750		1996		F	
	M ZR-7 750	750		1999		F	left
	M ZR-7S 750	750		2001		F	left
	M VN 800 CLASSIC	800		1996		F	
	M VN 800 DRIFTER	800		1999	2003	F	
	M VN 900 CLASSIC / CUSTOM / LIGHT TOURER	900		2006		F	
	M GPZ 1100	1100		1995	1997	F	left
	M ZR 1100 ZEPHYR	1100		1996	1997	F	left
	M ZR 1100 ZEPHIR	1100		1997	2000	F	
	M VN 1500 D1/D2 CLASSIC	1500		1996	1998	F	
	M VN 1500 CLASSIC TOURER	1500		1999		F	left



		CC	KW	FROM	TO	FRONT / REAR	LEFT / RIGHT
	M VN 1500 DRIFTER	1500		1999	2003	F	
	M VN 1500 CLASSIC FI	1500		1999		F	
	M VN 1600 CLASSIC	1600		2003		F	left
	M VN 1600 CLASSIC TOURER	1600		2005		F	left
	M VN 1700 Classic&Classic Tourer	1700		2009	2009	F	left
SUZUKI	M GSF 600 BANDIT - KATANA	600		1998		F	left
	M GSF 600 BANDIT	600		2000		F	left
	M SV 650 X ABS	645	56	2018		F	left
	M DL V-STROM 650 AK ABS	650		2007	2011	F	left
	M DL V-STROM 650 XK NO ABS	650		2007	2011	F	left
	M DL V-STROM 650AK GT Traveller ABS	650		2007	2011	F	left
	M DL V-STROM 650AL XP Xpedition ABS	650		2011	2011	F	left
	M DL V-STROM 650 AL ABS	650		2012		F	left
	M DL V-STROM 650 A XT ABS	650		2015		F	left
	M GSF 650 (Naked Bandid -Non ABS)	650		2005	2006	F	left
	M GSF 650 A (Naked Bandid -ABS)	650		2005	2006	F	left
	M GSF 650 S (Faired Bandid -Non ABS)	650		2005	2006	F	left
	M GSF 650 SA (Faired Bandid -ABS)	650		2005	2006	F	left
	M SV 650 S (Top Fairing - Non ABS)	650		1999	2002	F	left
	M SV 650 (Naked - Non ABS)	650		1999	2002	F	left
	M SV 650 (Naked - Non ABS)	650		2003	2010	F	left
	M SV 650 S (Top Fairing - Non ABS)	650		2003	2012	F	left
	M SV 650 A (Naked - ABS)	650		2007	2010	F	left
	M SV 650 SA (Top Fairing - ABS)	650		2007	2013	F	left
	M SV 650 ABS	650		2016		F	left
	M SFV GLADIUS 650 NO ABS	650		2009		F	left
	M SFV GLADIUS 650 ABS	650		2009		F	left
	M V-Strom 650 ABS	650		2016		F	left
	M V-Strom 650-XT ABS	650		2016		F	left
	M GSR 750 ABS&NO ABS	750		2011		F	left
	M GSX 750 FW/FX/FY/FK1/FK2	750		1998	2006	F	left
	M GSX 750 W/X/Y/K1	750		1998		F	left
	M VX 800	800		1995		F	
	M DL 1000 V-STROM (WVBS)	1000	72	2002	2010	F	left
	M INTRUDER C1500	1500		2005	2009	F	left
	M VL 1500 K2	1500		2002	2003	F	left

M = MOTORCYCLE
S = SCOOTER
A = ATV
Sn = SNOWMOBILE

FDB2049

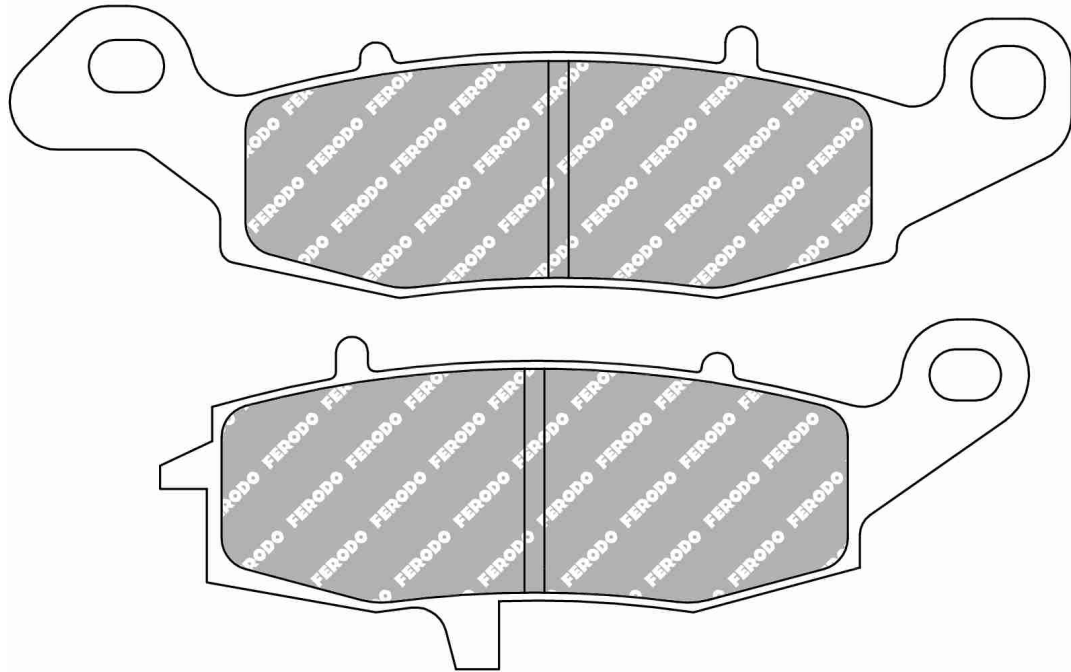

133.6 x 36.5 x 8.4 mm / 109.2 x 44.0 x 8.4 mm

MATERIAL AVAILABILITY											
AG	EF	P	PRP	ST	SM	SG	ZR	XRAC	ZRAC	CP1	CPR0
	✓	✓		✓				✓		✓	



ALSO AVAILABLE		
SHAPE	TH. MM	NOTES
FDB2048		Coupled set

CROSS REFERENCE	
BRAKING	787
BREMBO	07KA15
BREMBO	07KA18
BREMBO	07SU16
BRENTA	3091
BRENTA	4091
CL BRAKES	2384
EBC	FA231
EBC	FA259
GALFER	FD179
GOLD FREN	124
LUCAS/TRW	MCB681
NEWFREN	FD0227
SBS	704
VESRAH	VD-435

		CC	KW	FROM	TO	FRONT / REAR	LEFT / RIGHT
	M 650NK	650		2012	2014	F	right
	M 650TR	650		2013	2014	F	right
	M 650TK	650		2013	2014	F	right
	M VN 200	200		2007		R	
	M BJ 250 F1/F2 (250 TR)	250		2002	2003	F	
	M ER-6 650 F	650		2005		F	right
	M ER-6 650 N (ER650A)	650	53	2005	2008	F	right
	M ER-6 650 N ABS (ER650A)	650	53	2005	2008	F	right
	M ER-6 650 N (ER650A)	650	25	2006	2008	F	right
	M ER-6 650 N (ER650C)	650	25	2009	2011	F	right
	M ER-6 650 N (ER650C)	650	53	2009	2011	F	right
	M ER-6 650 N ABS	650	53	2011	2011	F	right

		CC	KW	FROM	TO	FRONT / REAR	LEFT / RIGHT
	M ER-6 650 N (ER650E)	650	25	2012		F	right
	M ER-6 650 N (ER650E)	650	35	2012		F	right
	M ER-6 650 N (ER650E)	650	53	2012		F	right
	M ER-6 650 N ABS (ER650E)	650	25	2012		F	right
	M ER-6 650 N ABS (ER650E)	650	35	2012		F	right
	M ER-6 650 N ABS (ER650E)	650	53	2012		F	right
	M Versys (LE650A)	650	53	2007	2009	F	right
	M Versys (LE650A)	650	47	2007	2009	F	right
	M Versys (LE650A)	650	25	2007	2009	F	right
	M Versys (LE650C)	650	25	2009	2013	F	right
	M Versys (LE650C)	650	47	2009	2013	F	right
	M W 650	650		1999		F	



		CC	KW	FROM	TO	FRONT / REAR	LEFT / RIGHT
M	Z 750 / Z 750 S	750		2004	2006	F	right
M	ZR-7 750	750		1999		R	
M	ZR-7 750	750		1999		F	right
M	ZR-7S 750	750		2001		R	
M	ZR-7S 750	750		2001		F	right
M	EJ800 (W 800 all model)	800		2011		F	
M	VN 800 DRIFTER	800		1999	2003	R	
M	VN 900 CLASSIC / CUSTOM / LIGHT TOURER	900		2006		R	
M	GPZ 1100	1100		1995	1997	F	right
M	ZR 1100 ZEPHYR	1100		1996	1997	F	right
M	MEAN STREAK 1500	1500		2002	2003	R	
M	VN 1500 DRIFTER	1500		1999	2003	R	
M	VN 1500 CLASSIC FI	1500		1999		R	
M	VN 1500 CLASSIC TOURER	1500		1999		F	right
M	VN 1600 CLASSIC	1600		2003		R	
M	VN 1600 CLASSIC	1600		2003		F	right
M	VN 1600 MEAN STREAK	1600		2004		R	
M	VN 1600 CLASSIC TOURER	1600		2005		R	
M	VN 1600 CLASSIC TOURER	1600		2005		F	right
M	VN 1700 Classic&Classic Tourer	1700		2009	2009	F	right
M	VN 1700 Classic&Classic Tourer	1700		2009	2009	R	
M	VN 1700 Voyager (B/BA)	1700		2009		R	
M	VN 1700 Classic&Classic Tourer ABS	1700		2010		R	
M	VN 1700 Voyager Custom (KB)	1700		2011		R	
M	VN 2000 VULCAN / CLASSIC	2000		2004		R	
SUZUKI	M RV 125 K2/ K3 / K4 VAN VAN	125		2002		F	
M	VAN VAN 125 (RV)	125		2010		F	
M	VAN VAN 200	200		2016		F	
M	GS 500 E - K - FK	500		1996		F	
M	GSF 600 BANDIT - KATANA	600		1998		F	right
M	GSF 600 BANDIT	600		2000		F	right
M	SV 650 X ABS	645	56	2018		F	right
M	DL V-STROM 650 XK NO ABS	650		2007	2011	F	right
M	DL V-STROM 650 AK ABS	650		2007	2011	F	right
M	DL V-STROM 650AK GT Traveller ABS	650		2007	2011	F	right
M	DL V-STROM 650AL XP Xpedition ABS	650		2011	2011	F	right
M	DL V-STROM 650 AL ABS	650		2012		F	right
M	DL V-STROM 650 A XT ABS	650		2015		F	right
M	GSF 650 (Naked Bandid -Non ABS)	650		2005	2006	F	right



		CC	KW	FROM	TO	FRONT / REAR	LEFT / RIGHT
M	GSF 650 A (Naked Bandid -ABS)	650		2005	2006	F	right
M	GSF 650 S (Faired Bandid -Non ABS)	650		2005	2006	F	right
M	GSF 650 SA (Faired Bandid -ABS)	650		2005	2006	F	right
M	SV 650 (Naked - Non ABS)	650		1999	2002	F	right
M	SV 650 S (Top Fairing - Non ABS)	650		1999	2002	F	right
M	SV 650 (Naked - Non ABS)	650		2003	2010	F	right
M	SV 650 S (Top Fairing - Non ABS)	650		2003	2012	F	right
M	SV 650 A (Naked - ABS)	650		2007	2010	F	right
M	SV 650 SA (Top Fairing - ABS)	650		2007	2013	F	right
M	SV 650 ABS	650		2016		F	right
M	SVF GLADIUS 650 NO ABS	650		2009		F	right
M	SVF GLADIUS 650 ABS	650		2009		F	right
M	V-Strom 650 ABS	650		2016		F	right
M	V-Strom 650-XT ABS	650		2016		F	right
M	XF 650 FREEWIND	650		1997	2002	F	
M	GSR 750 ABS&NO ABS	750		2011		F	right
M	GSX 750 FW/FX/FY/FK1/FK2	750		1998	2006	F	right
M	GSX 750 W/X/Y/K1	750		1998		F	right
M	INTRUDER M800 (VZ800)	800		2005	2013	F	
M	INTRUDER C800 - spoke wheel (VL 800)	800		2006	2013	F	
M	INTRUDER C800C - cast wheel (VL 800)	800		2007	2013	F	
M	INTRUDER M800 Z (VZ800)	800		2009	2010	F	
M	INTRUDER C800B - cast wheel (VL 800)	800		2014		F	
M	INTRUDER M800 /T (VZ800)	800		2014		F	
M	VL 800 INTRUDER VOLUSIA	800		2001	2005	F	
M	VZ 800 MARAUDER / K7	800		1997	2003	F	
M	DL 1000 V-STROM (WVBS)	1000	72	2002	2010	F	right
M	INTRUDER C1500	1500		2005	2009	F	right
M	INTRUDER C1500 BT-T	1500		2013		R	
M	M1500 INTRUDER	1500		2008		F	
M	M1500 INTRUDER	1500		2008		R	
M	VL 1500 K2	1500		2002	2003	F	right
M	VZ 1600 MARAUDER	1600		2004		R	
M	M 1800 R INTRUDER (VRZ)	1800		2006	2009	R	
M	M 1800 RZ INTRUDER (VRZ)	1800		2007	2013	R	
M	M 1800 R2 INTRUDER (VRZ)	1800		2008	2009	R	
M	M 1800 RB INTRUDER (VZR)	1800		2014		R	
M	VLR 1800 INTRUDER C1800 R/RT	1800		2008		R	

M = MOTORCYCLE
S = SCOOTER
A = ATV
Sn = SNOWMOBILE

FDB2050

100.1 x 55.9 x 8.4 mm

replacing FDB657

MATERIAL AVAILABILITY											
AG	EF	P	PRP	ST	SM	SG	ZR	XRAC	ZRAC	CP1	CPRO
		✓		✓							

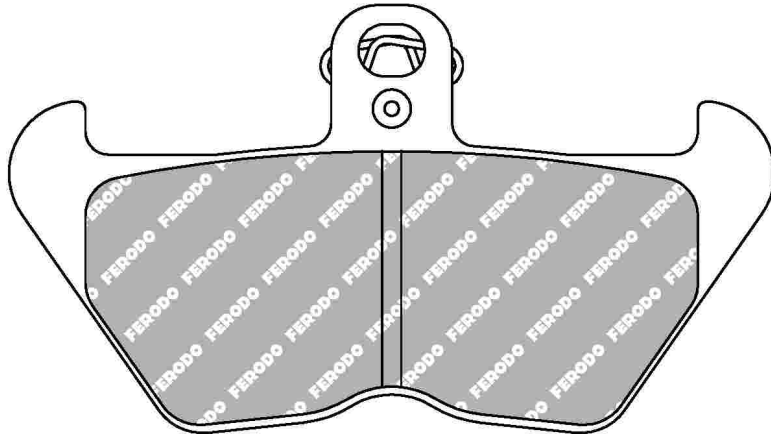

CROSS REFERENCE	
BRAKING	739
BRAKING	806
BREMBO	07BB22
CL BRAKES	2303
CL BRAKES	2430
EBC	FA407
EBC	Old FA170
EBC	Old FA246
GALFER	FD131
GALFER	FD198
GOLD FREN	117
LUCAS/TRW	MCB680
NEWFREN	FD0237
SBS	644
SBS	703
VESRAH	VD-941
VESRAH	VD-959
VESRAH	VD-984

		CC	KW	FROM	TO	FRONT / REAR	LEFT / RIGHT
	M R 80 800 R ROADSTER	800		1993	1994	F	
	M R 850 RT	850		1998	2001	F	
	M R 850 C	850		1999	2000	F	
	M R 850 GS	850		1999	2000	F	
	M K 1 1000	1000		1989	1993	F	
	M K 100 1000 RS 16 VALVES	1000		1990	1992	F	
	M R 100 1000 R	1000		1991	1995	F	
	M K 1100 LT (ABS)	1100		1992	1997	F	
	M K 1100 RS (ABS and NOT)	1100		1994	1999	F	
	M K 1100 RT (ABS)	1100		1994	1999	F	

		CC	KW	FROM	TO	FRONT / REAR	LEFT / RIGHT
	M R 1100 RS (ABS)	1100		1994	2001	F	
	M R 1100 GS (ABS)	1100		1994	1999	F	
	M R 1100 RT (ABS)	1100		1995	2001	F	
	M R 1100 R ROADSTER	1100		1995	2000	F	
	M R 1150 GS	1150		1998	2001	F	
	M R 1150 GS	1150		2001		F	
	M K 1200 LT (K589)	1200	72	1999	2001	F	
	M K 1200 RS	1200		1997	2001	F	
	M K 1200 ST	1200		1999	2001	F	
	M R 1200 C (259C)	1200		1997	2000	F	

FDB2054

73.5 x 43.5 x 7.2 mm

MATERIAL AVAILABILITY											
AG	EF	P	PRP	ST	SM	SG	ZR	XRAC	ZRAC	CP1	CPRO
						✓					

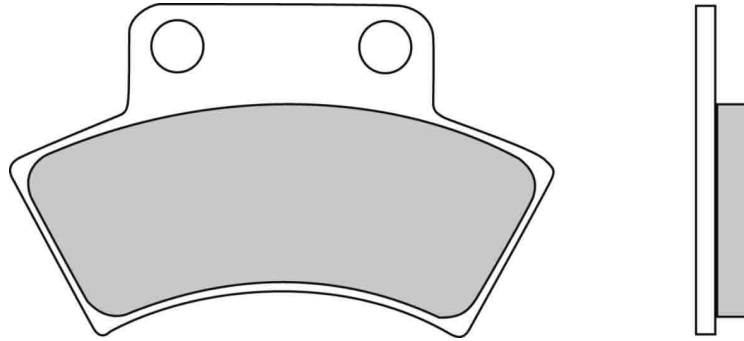

CROSS REFERENCE	
BRAKING	856
BREMBO	07PO03
CL BRAKES	2924
EBC	FA232
GALFER	FD300
LUCAS/TRW	MCB668
NEWFREN	FD0279
SBS	717
VESRAH	VD-950

		CC	KW	FROM	TO	FRONT / REAR	LEFT / RIGHT		
	CFMOTO	A	CF 500 CForce (5B/5C Classic Parking Brake)	500		2014	2015	F	
	PGO ATV	A	500 Bug Parking brake	500		2008	2009	F	
	POLARIS ATV	A	BIG BOSS (All standard models)			1989	1999	R	
		A	SCRAMBLER (All Models)			1995	1997	R	
		A	SPORTSMAN (All Models)			1993	1997	R	
		A	TRAIL BOSS (All Models)			1988	1999	R	
		A	250 2x4/4x4	250		1990	1995	R	
		A	TRAIL BLAZER 250	250		1990	1998	R	
		A	300 2x4/4x4	300		1990	1995	R	
		A	XPLORER 300	300		1996	2000	R	
		A	Xpress L (All models)	300		1996	2000	R	

		CC	KW	FROM	TO	FRONT / REAR	LEFT / RIGHT		
		A	L 350 2x4/4x4	350		1990	1995	R	
		A	Sportsman 350 4x4	350		1993		R	
		A	TRIAL BOSS 350 (All Models)	350		1991	1993	R	
		A	L 400 2x4/4x4	400		1990	1995	R	
		A	Sport 400	400		1994	1998	R	
		A	XPLORER 400	400		1995	1998	R	
		A	MAGNUM 425 (All Models)	425		1995	1998	R	
		A	XPLORER 500	500		1997	2000	R	
	QUADZILLA	A	CUV 500 Side X Side Parking Brake	500		2010	2011	R	
		A	QZ 500 E/ES 4x4 Parking brake	500		2009	2011	F	

M = MOTORCYCLE
S = SCOOTER
A = ATV
Sn = SNOWMOBILE

FDB2055

97.0 x 39.5 x 6.9 mm

MATERIAL AVAILABILITY

AG	EF	P	PRP	ST	SM	SG	ZR	XRAC	ZRAC	CP1	CPRO
						✓					

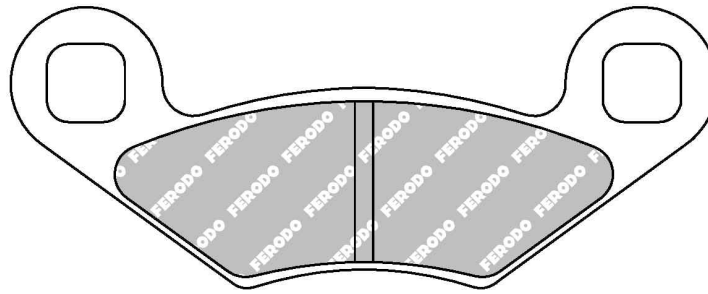
**CROSS REFERENCE**

BRAKING	857
BREMBO	07PO01
BREMBO	7104
BRENTA	4157
BRENTA	4158
CL BRAKES	2927
EBC	FA159
GALFER	FD303
LUCAS/TRW	MCB619
LUCAS/TRW	MCB761
NEWFREN	FD0280
SBS	642
SBS	716
VESRAH	VD-940



		CC	KW	FROM	TO	FRONT / REAR	LEFT / RIGHT
PEUGEOT	S Metropolis RS	400		2014		F	
	S Metropolis RS	400		2014		R	
	S Metropolis SPORT	400		2014		F	
	S Metropolis SPORT	400		2014		R	
	S Metropolis GT Connect	400		2015		F	
	S Metropolis GT Connect	400		2015		R	
POLARIS ATV	A BIG BOSS (All standard models)			1989	1999	F	
	A BIG BOSS (All middle axle brake models)			1989	1999	F	
	A MAGNUM (All models)			1999	2001	F	
	A MAGNUM (All models)			2002	2006	F	
	A SCRAMBLER (All Models)			1995	1997	F	
	A SCRAMBLER (All Models)			1998	2004	F	
	A SPORTSMAN (All Models)			1993	1997	F	
	A TRAIL BOSS (All Models)			1988	1999	F	
	A TRAIL BOSS (All Models)			2000	2004	F	
	A 250 2x4/4x4	250		1990	1995	F	
	A TRAIL BLAZER 250	250		1990	1998	F	
	A TRAIL BLAZER 250	250		1999	2004	F	
	A TRAIL BLAZER 250	250		2005	2006	F	
	A XPLOER 250	250		2000		F	
	A 300 2x4/4x4	300		1990	1995	F	
	A HAWKEYE 300 2x4	300		2006		F	
	A HAWKEYE 300 2x4	300		2006		R	
	A HAWKEYE 300 4x4	300		2007		F	
	A HAWKEYE 300 4x4	300		2007		R	
	A Sportsman 300 4x4	300		2008	2010	F	
	A Sportsman 300 4x4	300		2008	2010	R	
	A XPLOER 300	300		1996	2000	F	
	A Xpress L (All models)	300		1996	2000	F	
	A XPEDITION 325	325		2000	2001	F	
	A XPEDITION 325	325		2002		F	
	A ATP 330	330		2004	2005	F	
	A ATP 330	330		2004	2005	R	
A Trail Blazer 330	330		2008	2010	F		
A TRAIL BOSS 330	330		2005	2010	F		
A SPORTSMAN 335	335		1999	2000	F		
A L 350 2x4/4x4	350		1990	1995	F		
A Sportsman 350 4x4	350		1993		F		
A TRIAL BOSS 350 (All Models)	350		1991	1993	F		



		CC	KW	FROM	TO	FRONT / REAR	LEFT / RIGHT
A	L 400 2x4/4x4	400		1990	1995	F	
	A Sport 400	400		1994	1998	F	
	A Sport 400	400		1999	2000	F	
	A SPORTSMAN 400	400		2001	2002	F	
	A SPORTSMAN 400	400		2003	2005	F	
	A Sportsman 400 HO 4x4	400		2008	2010	F	
	A Sportsman 400 HO 4x4	400		2008	2010	R	
	A XPLOER 400	400		1995	1998	F	
	A XPLOER 400	400		1999	2002	F	
	A MAGNUM 425 (All Models)	425		1995	1998	F	
	A XPEDITION 425	425		2000		F	
	A Outlaw S 450	450		2008		R	
	A Outlaw MXR 450	450		2009	2011	R	
	A Sportsman 450	450		2006		F	
	A DIESEL 455	455		1999	2001	F	
	A ATP 500 H0	500		2004	2005	F	
	A ATP 500 H0	500		2004	2005	R	
	A Outlaw 500	500		2006	2007	F	
	A Outlaw 500	500		2006	2007	R	
	A PREDATOR 500	500		2003	2007	F	
	A PREDATOR 500	500		2003	2007	R	
	A SCRAMBLER 500 (All models)	500		2005	2010	F	
	A SPORTSMAN 500	500		1998	2002	F	
	A SPORTSMAN 500 6x6	500		2000	2008	F	
	A SPORTSMAN 500 HO/EFI/X2/EFI Quad H.O.	500		2003	2010	F	
	A Sportsman 500 X2 EFI	500		2007	2009	F	
	A Sportsman 500 X2 EFI	500		2007	2009	R	
	A Sportsman 500 Touring H.O.	500		2008	2010	F	
	A Sportsman 500 Touring H.O.	500		2008	2010	R	
	A XPLOER 500	500		1997	2000	F	
	A Outlaw S 525	525		2008	2011	R	
	A Outlaw IRS 525	525		2008	2013	R	
	A RZR 570	570		2012	2014	R	
	A SPORTSMAN 600	600		2003	2006	F	
	A SPORTSMAN 700	700		2003	2007	F	
	A Sportsman 700 X2	700		2008		F	
	A Sportsman 700 X2	700		2008		R	
A RZR 800 (EPS Models)	800		2008	2014	R		
A SPORTSMAN 800 EFI/HO	800		2005	2010	F		

4170

FERODO

RACING

Updated on November 2020

M = MOTORCYCLE
S = SCOOTER
A = ATV
Sn = SNOWMOBILE

		CC	KW	FROM	TO	FRONT / REAR	LEFT / RIGHT
	A Sportsman 800 X2 EFI	800		2007	2009	F	
	A Sportsman 800 X2 EFI	800		2007	2009	R	
	A Sportsman 800 Touring/EFI	800		2008	2009	F	

		CC	KW	FROM	TO	FRONT / REAR	LEFT / RIGHT
	A Sportsman 800 Touring/EFI	800		2008	2009	R	
	A Sportsman 800 EFI 6x6 Big Boss	800		2009	2010	F	
	A Sportsman 800 EFI 6x6 Big Boss	800		2009	2010	R	

FDB2057

35.8 x 49.1 x 7.0 mm

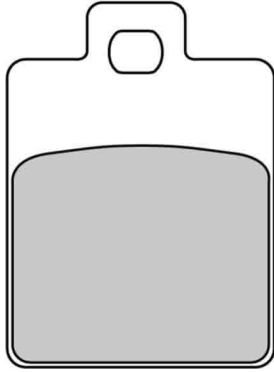

MATERIAL AVAILABILITY											
AG	EF	P	PRP	ST	SM	SG	ZR	XRAC	ZRAC	CP1	CPO
✓	✓										

CROSS REFERENCE	
BRAKING	808
BREMBO	07019
BREMBO	7019
BREMBO	7067
BRENTA	3014
BRENTA	4014
CL BRAKES	3043
EBC	SFA260
GALFER	FD200
GOLD FREN	137
LUCAS/TRW	MCB695
NEWFREN	FD0249
SBS	142
SBS	202

		CC	KW	FROM	TO	FRONT / REAR	LEFT / RIGHT
CPI	M GTR 50	50		2003		R	
	M GTS 50 / 125 / 200	125		2002	2003	R	
DERBI	M SONAR 125 (4T)	125		2010	2011	F	
GILERA	M DNA 50	50		2001		R	
	S RUNNER 50 SP / SKP	50		1999	2005	R	
	S RUNNER 50 SP / SKP	50		2006		R	
	M STALKER 50	50		1997		R	
	M RUNNER 125 FX - SP	125		2000		R	
	M RUNNER 180 FXR - SP	180		1999		R	
KEEWAY	M FUOCO 500 RC/ie	500		2007		F	
	S Cityblade 150	150		2013		R	
PEUGEOT	S Tweet 50 RS (4T/Rear Disc Model)	50		2010	2012	R	
	S Tweet 50 Evo RS	50		2014		R	
	S City Star 125 (AC/Carb)	125		2011		R	
	S City Star 125 i (LC)	125		2013		R	
	S SATELIS 125	125		2013		R	
	S SATELIS 125 RS (4T)	125		2013		R	
	S Tweet 125 Evo RS (4T/Rear Disc Model)	125	6	2011		R	
	S City Star 151 (AC/Carb)	150		2011		R	
	S Tweet 150 RS (4T/Rear Disc Model)	150		2011		R	
	S City Star 200 i	200		2012		R	
PGO	S Tigra125 (4T/4V)	125		2012		R	
PIAGGIO	S Liberty Elettrico			2011	2012	F	
	M LIBERTY 50	50		1997	2003	F	

		CC	KW	FROM	TO	FRONT / REAR	LEFT / RIGHT
	S Liberty Sport 50 2T	50		2007	2008	F	
	M NRG 50 POWER DD / Silver Bullet	50		2005		R	
	M NRG 50 MC2 DD	50		1998		R	
	M NRG 50 EXTREME (Rear disc model)	50		1999	2001	R	
	M NRG 50 MC3 DD (Rear disc model)	50		2001	2005	R	
	M NRG 50 Power Pure Jet	50		2004	2010	R	
	M NRG 50 Power DD	50		2005	2013	R	
	M NRG 50 Silver Bullet	50		2010	2010	R	
	M VESPA 50 ET2	50		1997	1998	F	
	M VESPA 50 ET4	50		1999		F	
	M VESPA LX 50 2T	50		2005		F	
	M VESPA LX 50 4T	50		2005		F	
	S VESPA S 50 (2T)	50		2007	2013	F	
	S Vespa LXV 50	50		2007	2009	F	
	S VESPA S 50 (4T/4V)	50		2008	2013	F	
	M VESPA LX 50 2T TOURING	50		2010		F	
	M VESPA LX 50 4T TOURING	50		2010		F	
	S VESPA S 50 Sport (2T)	50		2011	2013	F	
	S VESPA S 50 Sport (4T/4V)	50		2011	2013	F	
	M ZIP 50 SP	50		1996	2000	F	
	M ZIP 50 RST	50		1996	1997	F	
	M ZIP 50 RST	50		1998	1999	F	
	M ZIP 50 Grimeca/Heng Tong A/C 4T	50		2000	2008	F	
	M ZIP 50 SP	50		2001	2006	F	

M = MOTORCYCLE
S = SCOOTER
A = ATV
Sn = SNOWMOBILE

		CC	KW	FROM	TO	FRONT / REAR	LEFT / RIGHT
S	Zip 100	100		2007		F	
M	Liberty 125 (5 Spoke wheels)(M11)	125	7	1998	2003	F	
S	Liberty 125 4T 2V (10 Spoke Cast Wheels)(M38)	125	8	2004	2012	F	
S	Liberty Sport 125	125		2006	2008	F	
S	Liberty 125 4T 3V i.e. (10 Spoke Cast Wheels)(M73)	125	8	2013		F	
S	MP3 125 ie	125		2006		F	
S	MP3 Hybrid 125	125		2010		F	
M	SFERA 125 (4 stroke)	125		1996		F	
M	VESPA 125 ET4	125		1996		F	
M	VESPA LXV 125 / LX 125 / LXW 125 / Touring	125		2005	2013	F	
S	Vespa S 125 (4T)	125		2007	2013	F	
S	Vespa S 125 Sport (4T)	125		2011	2013	F	
S	125 ie MP3 Yourban	125		2011	2012	F	
M	ZIP 125	125		2000		F	
S	LIBERTY 150 (5 Spoke Wheels)	150	9	2000	2003	F	
S	LIBERTY 150 4T (5 Spoke Wheels)	150		2008	2008	F	
S	Liberty 150 4T (10 Spoke Cast Wheels)(M67)	150	9	2009	2012	F	
S	Liberty 150 i.e. 4T 3V (10 Spoke Cast Wheels)(M73)	150	8	2013		F	
M	VESPA 150 ET4	150		1996		F	
S	VESPA LX 150	150		2005		F	
S	VESPA S 150 (4T)	150		2007	2013	F	
S	VESPA S 150 Sport (4T)	150		2011	2012	F	
S	VESPA LX 150 (Serie Speciali/4T)	150		2012		F	
M	SUPER HEXAGON 180 GTX	180		2000		R	
S	Liberty S 200	200		2007	2008	F	
S	MP3 250	250		2007		F	
S	MP3 LT 300 ie	300		2010	2011	F	

		CC	KW	FROM	TO	FRONT / REAR	LEFT / RIGHT
S	MP3 Hybrid 300 ie 4T 4V	300		2010	2013	F	
S	MP3 Hybrid LT 300 ie 4T 4V	300		2010	2011	F	
S	MP3 MIC 300 ie	300		2010	2011	F	
S	MP3 Touring 300 ie	300		2011	2012	F	
S	MP3 Touring LT 300 ie	300		2011	2012	F	
S	MP3 300 ie LT Sport	300		2011	2013	F	
S	300 ie MP3 Yourban	300		2011	2012	F	
S	300 ie MP3 Yourban LT	300		2011		F	
S	300 ie MP3 Yourban LT Sport	300		2015		F	
S	MP3 400 ie	400		2007	2008	F	
S	MP3 LT 400 ie	400		2009		F	
S	MP3 500 i.e. Bussines	500		2011	2012	F	
S	MP3 500 i.e. LT Bussines	500		2011	2013	F	
S	MP3 500 i.e. LT Sport	500		2011	2013	F	
S	MP3 500 i.e. Sport	500		2012	2012	F	
SYM	Symphony 50 SR (4T/Rear disc model)	50		2010		R	
S	Symphony S 50 (4T/Rear disc model)	50		2010		R	
S	Symphony 50 ST	50		2015		R	
S	Symphony 125 SR (4T/Rear disc model)	125		2010		R	
S	Symphony 125 S (4T/Rear disc model) (AY12W7)	125	7	2010		R	
S	Symphony 125 ST	125		2015		R	
S	Symphony Cargo 125 i	125		2015		R	
S	Symphony 151 SR (4T/Rear disc model)	151		2010		R	
S	Symphony S 151 (4T/Rear disc model)	151		2010		R	
S	Fiddle III 200i (4T)	200		2014		R	
S	Symphony 200ST	200		2015	2018	R	

FDB2058

52.7 x 56.4 x 8.6 mm

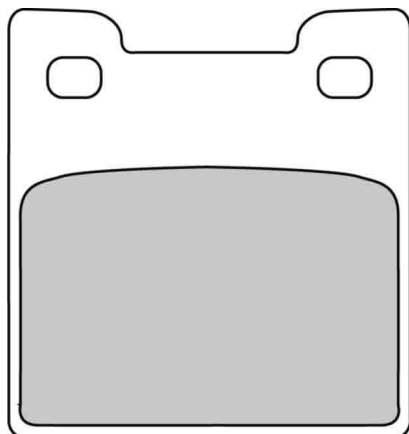

MATERIAL AVAILABILITY

AG	EF	P	PRP	ST	SM	SG	ZR	XRAC	ZRAC	CP1	CPRO
		✓									

CROSS REFERENCE

BREMBO	07SU20
CL BRAKES	2390
EBC	FA222
GALFER	FD189
LUCAS/TRW	MCB678
NEWFREN	FD0217
SBS	701
VESRAH	VD-350



SUZUKI

M RF 900 RR

CC

KW

FROM

TO

FRONT / REAR LEFT / RIGHT

1994 1995

R

FDB2060

79.1 x 47.3 x 7.6 mm

MATERIAL AVAILABILITY

AG	EF	P	PRP	ST	SM	SG	ZR	XRAC	ZRAC	CP1	CPRO
✓		✓									

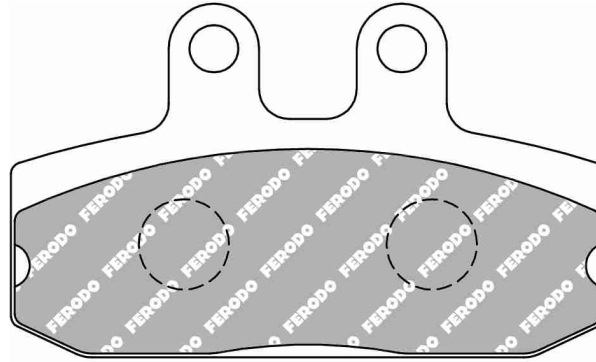

ALSO AVAILABLE		
SHAPE	TH. MM	NOTES
FDB438		Material swept depth different

CROSS REFERENCE

BREMBO	07007
BREMBO	7007
CL BRAKES	3020
EBC	FA256
GALFER	FD195
LUCAS/TRW	MCB673
NEWFREN	FD0238
SBS	124
VESRAH	VD-152



		CC	KW	FROM	TO	FRONT / REAR	LEFT / RIGHT
APRILIA	S Sport City Cube 125	125		2008	2012	F	
	S Sport City Cube 200	200		2008	2009	F	
	S SCARABEO 500	500		2003		F	
HONDA	M NA 850 MANA ABS / GT	850		2008		R	
	M SJ 50 BALI	50		1993	1999	F	
	M SJ 100 BALI - EX	100		1998	1999	F	
MOTO GUZZI	M CA 125 REBEL	125		1998		F	
	M V7 II Racer	750		2012		R	
	M V7 II Special	750		2012		R	
	M V7 II Stone	750	25	2012	2014	R	
	M V7 II Stone	750	37	2012		R	



		CC	KW	FROM	TO	FRONT / REAR	LEFT / RIGHT
	M V7 II Stornello	750		2016		R	
	M V7 III Anniversario	750		2017		R	
	M V7 III Racer	750		2017		R	
	M V7 III Special	750		2017		R	
	M V7 III Stone	750		2017		R	
	M V9 Bobber	850		2016		R	
	M V9 Roamer	850		2016		R	
	M V85 TT	853	59	2020		R	
	M V9	900		2017		R	
	M V9 X-Track	900		2017		R	

M = MOTORCYCLE
S = SCOOTER
A = ATV
Sn = SNOWMOBILE

FDB2062

45.7 x 52.6 x 6.4 mm

August 2016: AG superseded by EF

MATERIAL AVAILABILITY											
AG	EF	P	PRP	ST	SM	SG	ZR	XRAC	ZRAC	CP1	CPRO
X	✓										

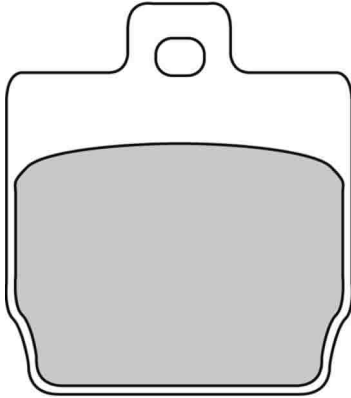

CROSS REFERENCE	
BRAKING	814
BREMBO	07066
BREMBO	07BB08
BREMBO	7066
BRENTA	3016
BRENTA	4016
CL BRAKES	3027
EBC	FA268
EBC	SFA268
GALFER	FD206
GOLD FREN	128
LUCAS/TRW	MCB701
NEWFREN	FD0251
SBS	145
SBS	731
VESRAH	VD-960

		CC	KW	FROM	TO	FRONT / REAR	LEFT / RIGHT
	CPI	M	OLIVER / TNT / STUNT 50	50	2006	F	
	MBK	M	NITRO 50	50	1997	R	
	YAMAHA	S	NS 50 F (1GB) AEROX 4 (4T)	50	2013	R	

		CC	KW	FROM	TO	FRONT / REAR	LEFT / RIGHT
	S		NS 50 AEROX R	50	2013	R	
	S		NS 50 AEROX R NAKED	50	2013	R	
	S		YQ 50 AEROX / AEROX R	50	1997	2012	R

FDB2073

115.6 x 41.0 x 8.0 mm

MATERIAL AVAILABILITY											
AG	EF	P	PRP	ST	SM	SG	ZR	XRAC	ZRAC	CP1	CPRO
	✓	✓		✓	✓						

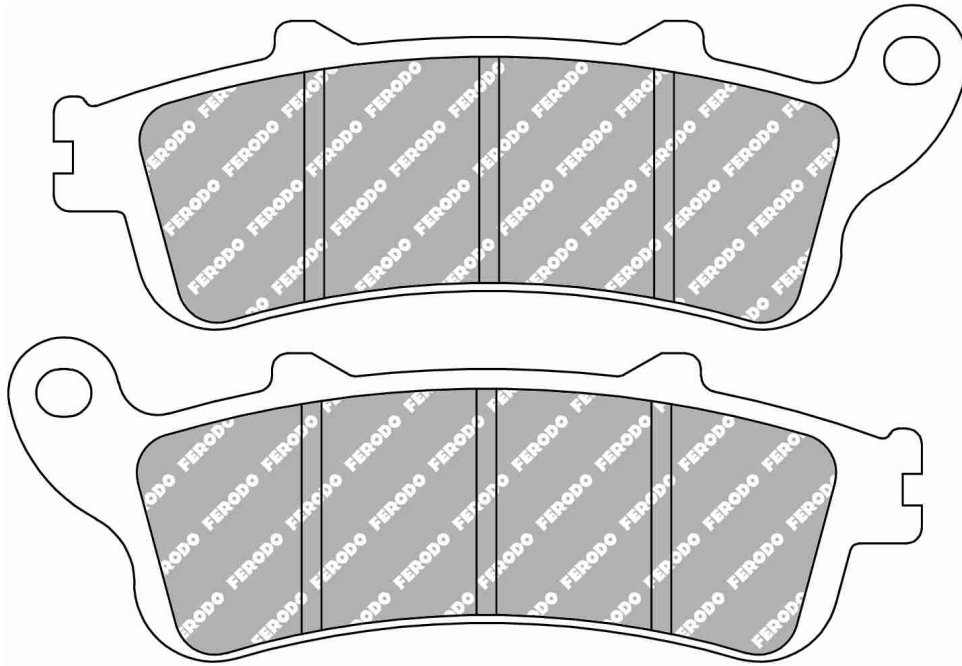

ALSO AVAILABLE		
SHAPE	TH. MM	NOTES
FDB2075	9.4	
FDB2098	8.3	

CROSS REFERENCE	
BRAKING	813
BREMBO	07034
BREMBO	07HO42
BREMBO	7034
BRENTA	3023B
BRENTA	4023B
CL BRAKES	2602
CL BRAKES	3026
EBC	FA261
EBC	FA261HH
GALFER	FD205
GOLD FREN	135
GOLD FREN	178
LUCAS/TRW	MCB692
NEWFREN	FD0253
SBS	147
SBS	721
VESRAH	VD-165/2
VESRAH	VD-165/3

		CC	KW	FROM	TO	FRONT / REAR	LEFT / RIGHT
HONDA	S	FES 125 PANTHEON	125	1998	1999	F	
	S	FES 150 PANTHEON	150	1998	1999	F	
	S	FES 250 FORESIGHT	250	1997	1998	F	
	S	JAZZ 250	250	2001		F	
	S	Silver Wing 400 (FJS400)	400	2002		F	
	S	Silver Wing GT400 (FJS400D)	400	2003	2008	F	
	S	Silver Wing GT400 ABS (FJS400A)	400	2003	2008	F	
	S	SILVERWING 400	400	2006		F	
	S	Silver Wing 600 (FJS600)	600	2001	2002	F	
	S	Silver Wing (FSC600)	600	2002	2007	F	
	S	Silver Wing (FSC600D)	600	2003	2008	F	

		CC	KW	FROM	TO	FRONT / REAR	LEFT / RIGHT	
	S	Silver Wing 600 (FJS600D)	600	2003	2008	F		
	S	Silver Wing GT ABS (FJS600A)	600	2003	2008	F		
	S	Silver Wing GT600 ABS (FSC600A)	600	2009	2017	F		
	S	SILVER WING 600 (FJS)	600	2001	2008	F		
	M	DEAUVILLE TRAVEL	680	2007		R		
	M	CB 1100 HORNET	1100	1999	2000	R		
	M	CBR 1100 XX Superblackbird	1100	1996	1997	F		
	M	X 11 1100	1100	2000	2002	F		
	KAWASAKI	M	Vulcan S Cafe	649	2017		F	
		M	Vulcan S	650	45	2015	F	

FDB2074

51.0 x 54.0 x 7.5 mm

MATERIAL AVAILABILITY											
AG	EF	P	PRP	ST	SM	SG	ZR	XRAC	ZRAC	CP1	CPRO
✓	✓	✓		✓	✓						✉

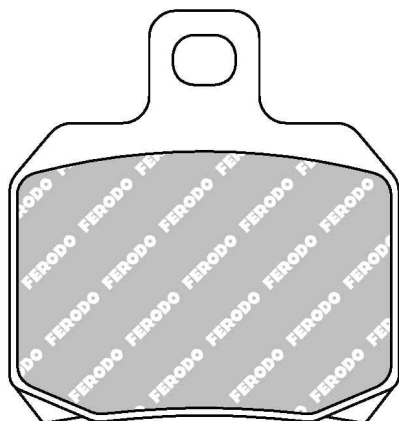

Pinze / Calipers

BREMBO

2-Piston, new for 1997 (P32G)

CROSS REFERENCE	
BRAKING	828
BREMBO	07004
BREMBO	07BB20
BREMBO	07BB32
BREMBO	7004
BRENTA	3035
BRENTA	4035
CL BRAKES	2827
EBC	FA266
GALFER	FD220
GOLD FREN	152
LUCAS/TRW	MCB700
NEWFREN	FD0256
SBS	157
SBS	730
VESRAH	VD-964

		CC	KW	FROM	TO	FRONT / REAR	LEFT / RIGHT
ADIVA	S	AD 400	400	2009	2011	F	
	S	AD 400	400	2009	2011	R	
APRILIA	M	RS 50	50	2006	2011	F	
	M	RS 660	660	2020		R	
	M	Tuono 660	660	2020		R	
	M	ETV 1000 CAPONORD / RALLY RAID	1000	2001	2007	R	
	M	RSV 1000 MILLE	1000	1997	2000	R	
	M	RSV 1000 MILLE	1000	2001		R	
	M	RSV 1000 TUONO	1000	2004		R	
	M	RSV 1000 MILLE TUONO RACING	1000	2004		R	
M	RSV 1000 MILLE R / SP	1000	2000	2000	R		

		CC	KW	FROM	TO	FRONT / REAR	LEFT / RIGHT
	M	RSV 1000 MILLE R	1000	2001	2003	R	
	M	RSV 1000 MILLE R FACTORY	1000	2004		R	
	M	RSV4 Factory /APRC SE /R	1000	2008		R	
	M	RSV4 Factory APRC ABS	1000	2013		R	
	M	RSV4 R APRC ABS	1000	2013		R	
	M	RSV4 RR	1000	2015		R	
	M	RSV4 RF	1000	2016		R	
	M	SL 1000 FALCO	1000	2000		R	
	M	TUONO V4 R	1000	2011	2012	R	
	M	TUONO V4 R APRC	1000	2011	2013	R	
	M	TUONO V4 R APRC ABS	1000	2013		R	

4176



M = MOTORCYCLE
S = SCOOTER
A = ATV
Sn = SNOWMOBILE



		CC	KW	FROM	TO	FRONT / REAR	LEFT / RIGHT
	M TUONO V4 Factory	1078		2015		R	
	M TUONO V4 RR	1078		2015		R	
	M TUONO V4 RR/Factory	1100		2017		R	
BENELLI	M LEONCINO 500	500		2016		R	
	M TRK 502	500		2016		R	
	M BN 600i	600		2014		R	
	M BN 600R	600		2014		R	
	M BN 600GT	600		2015		R	
	M 2 UE 750	750		2009	2010	R	
	M TNT 899	899		2007		R	
	M TNT 899 S	899		2007	2011	R	
	M TNT Cafe Racer 899	899		2010	2012	R	
	M TNT Century Racer 899	899		2011	2012	R	
	M TRE-K 899	899		2007	2014	R	
	M 900 TORNADO	900		2000		R	
	M TORNADO TRE 900	900		2002		R	
	M TORNADO TRE 900 RS	900		2003		R	
	M TNT 1130 Sport/Sport Evo	1130		2004	2009	R	
	M TNT 1130 Cafe Racer	1130		2005	2005	R	
	M TNT 1130 Titanium	1130		2005	2005	R	
	M TNT 1130	1130		2006	2010	R	
	M TNT 1130 Titanium	1130		2006	2006	R	
	M TNT 1130 Cafe Racer	1130		2006	2012	R	
	M TORNADO TRE 1130	1130		2006		R	
	M TNT R 160	1130		2009	2012	R	
	M TNT 1130 Century Racer	1130		2011		R	
	M TNT 1130 R	1130		2011	2013	R	
	M TNT 1130 R	1130		2014		R	
	M TRE-K 1130	1130		2006		R	
	M TRE-K 1130 Amazonas	1130		2007		R	
BIMOTA	M Tesi 3D Race Cafe'	800		2016		R	
	M DB6 Delirio (992cc) Ducati engine	992		2007		R	
	M BB3	1000		2014		R	
	M DB5 (All models)	1000		2006	2007	R	
	M DB5R	1078		2006	2007	R	
	M DB6 Delirio	1078		2006		R	
	M Tesi 3D Naked	1078		2007		R	
	M DB7 (1098cc)	1098		2008		R	
	M DB7 Oronero Millenovantotto	1098		2009		R	
	M DB6 (1100cc)	1100		2008		R	
	M DB6R Delirio (1100cc)	1100		2008		R	
	M DB8 (1198cc)	1198		2010		R	
	M DB8 Oronero	1198		2010		R	
	M DB9 Brivido	1198		2012		R	
	M Impeto	1198		2016		R	
BOMBARDIER ATV	A TRAXTER 500 (4x4/XL/Autoshift)	500		1999	2001	F	
	A TRAXTER 500 (4x4/XL/Autoshift)	500		1999	2001	F	
	A Traxter 650 (XT-4x4/Footshift)	650		2000		F	
	A Traxter 650 (XT-4x4/Footshift)	650		2000		R	
CAGIVA	M RAPTOR 650 / 650 i.e.	650		2001		R	
	M V RAPTOR 650	650		2001		R	
	M RAPTOR 1000	1000		2000		R	
	S RAPTOR V 1000	1000		2001		R	
	M RAPTOR X3 1000	1000		2003		R	
	M RAPTOR XTRA 1000	1000		2003		R	
CFMOTO	S CF 125 T-22 Glory	125		2010	2011	R	
	S CF 125 T-21A E-Charms	125		2010	2012	R	
	S CF 150 T-6A Glory	150		2010	2011	R	
	S CF 150 T-5i E-Charms	150		2010	2012	R	
	S CF 250 T - 6A (Scooter)	250		2012		R	
CPI	M GTR 50	50		2003		F	
	M X-LARGE 125 / 150 / 200	125		2002		F	
	M X-LARGE 125 / 150 / 200	125		2002		R	
DERBI	M GPR 50 NAKED	50		2004	2006	F	
	M GPR 50 Race Replica	50		2008	2009	F	
	M SENDA DRD PRO 50	50		2005	2007	F	
	M SENDA DRD Pro 50 SM	50		2008		F	
	M SENDA DRD Evo 50	50		2008		F	
	M GPR 80 CUP	80		2004	2007	F	
	M GPR 80 CUP Criterium Derbi Malossi	80		2008		F	
	M MULHACEN CAFE' 125	125		2008		F	
	M SENDA DRD 125	125		2010		F	
	M MULHACEN CAFE' 659 Angel Nieto Lim. Ed.	659		2008		R	
DUCATI	M M 600 MONSTER	600		2001	2002	R	
	M M 620 MONSTER	620		2002	2003	R	
	M MULTISTRADA 620 DARK (single disc)	620		2005	2006	R	
	M SPORT 620	620		2003		R	
	M MONSTER 695	695		2006	2008	R	
	M MONSTER 696	696		2008	2013	R	
	M 748 SPS	748		1998		R	



		CC	KW	FROM	TO	FRONT / REAR	LEFT / RIGHT
	M 748 / 748R / 748S	748		2001		R	
	M 749 / 749R / 749S / 749 DARK	749		2003		R	
	M 750 SUPERSPORT	750		1998	2002	R	
	M 750 SPORT	750		2001	2002	R	
	M M 750 MONSTER	750		2001	2002	R	
	M HYPERMOTARD 796	796		2010		R	
	M MONSTER 796 (ABS Std)	796		2011	2013	R	
	M 800 SUPERSPORT	800		2003		R	
	M HYPERMOTARD SP 821 (ABS Std)	821		2013		R	
	M HYPERMOTARD 821 (ABS Std)	821		2013		R	
	M HYPERSTRADA 821 (ABS Std)	821		2013		R	
	M MONSTER 821 (M7)	821	35	2015		R	
	M MONSTER 821 DARK	821		2015		R	
	M MONSTER 821 Stripe	821		2015		R	
	M MONSTER 821 (M6)	821	82	2015		R	
	M Monster 821	821	80	2018		R	
	M 848	848		2008		R	
	M Superbike 848 EVO	848		2011		R	
	M Streetfighter 848	849		2014		R	
	M 899 Panigale (ABS Std)	898		2014		R	
	M FE 900 SUPERSPORT	900		1998		R	
	M M 900 MONSTER	900		2001		R	
	M 916 SUPERSPORT 4	916		1998		R	
	M 916 STRADA	916		1998		R	
	M 916 ST2	916		2001	2002	R	
	M HYPERMOTARD 939 SP	937	83	2016		R	
	M HYPERMOTARD 939 (BA)	937	83	2016		R	
	M Hypermotard 950	937	84	2019		R	
	M Hypermotard 950 SP	937	84	2019		R	
	M HYPERSTRADA 939	937	83	2016		R	
	M Supersport S	937	81	2017		R	
	M Supersport	937	81	2017		R	
	M 944 ST2	944		1997	2002	R	
	M 944 SUPERSPORT 2	944		1998	2002	R	
	M 944 ST4	944		1999		R	
	M 959 Panigale	955	110	2016		R	
	M 959 Panigale Corse	955	110	2018		R	
	M Panigale V2	955	114	2020		R	left
	M ST3 992	992		2004		R	
	M 996 SPS / S	996		1998		R	
	M 996 R TESTA STRETTA	996		2001		R	
	M ST4 / ST4 ABS 996	996		2001		R	
	M 998 BIPOSTO	998		2002		R	
	M Panigale V4R	998	162	2019		R	
	M 999 R / S	999		2003		R	
	M Desmosedici RR (Lim. Ed.)	1000		2008		R	
	M GT 1000	1000		2006	2007	R	
	M MONSTER S2R 1000	1000		2008		R	
	M MONSTER S4R /S4RS 1000	1000		2008		R	
	M MULTISTRADA 1000 / 1000 DS / 1000S DS	1000		2003	2006	R	
	M PAUL SMART 1000 Limited Edition	1000		2007		R	
	M SPORT 1000	1000		2006		R	
	M SUPERSPORT 1000 DS	1000		2003		R	
	M 1098 /1098 S / 1098 R Bayliss Lim. Ed.	1098		2007		R	
	M STREETFIGHTER S	1099		2011		R	
	M HYPERMOTARD 1100	1100		2007		R	
	M HYPERMOTARD 1100S	1100		2007		R	
	M HYPERMOTARD 1100 EVO	1100		2010		R	
	M HYPERMOTARD 1100 SP / EVO SP / Corse ed.	1100		2010		R	
	M MONSTER 1100 / 1100 S	1100		2009		R	
	M MULTISTRADA 1100 / 1100 S / S Touring / S Sport	1100		2007		R	
	M Streetfighter / S	1100		2010		R	
	M Panigale V4S Corse	1103	157	2018		R	
	M Panigale V4	1103	157	2018		R	
	M Panigale V4 S	1103	157	2018		R	
	M Panigale V4 Speciale	1103	157	2018		R	
	M Street fighter V4 S	1103	153	2020		R	left
	M 1199 Panigale S (ABS Std)	1198		2012		R	
	M 1199 Panigale (ABS Std)	1198		2014		R	
	M 1199 Panigale R (ABS Std)	1198		2013	2017	R	
	M MULTISTRADA 1200S Touring (ABS Std)	1198		2010		R	
	M MULTISTRADA 1200S Pikes peak (ABS Std)	1198		2014		R	
	M MULTISTRADA 1200S Granturismo (ABS Std)	1198		2014		R	
	M MULTISTRADA 1200	1198	110	2014		R	
	M MULTISTRADA 1200	1198	112	2015		R	
	M MULTISTRADA 1200	1198	73	2015		R	
	M SUPERBIKE 1198 / S / S Corse / R / SP	1198		2009		R	
	M 1199 Panigale Superleggera	1199		2014		R	
	M MONSTER 1200	1200	108	2014		R	
	M MONSTER 1200S	1200	108	2014		R	

M = MOTORCYCLE
S = SCOOTER
A = ATV
Sn = SNOWMOBILE



		CC	KW	FROM	TO	FRONT / REAR	LEFT / RIGHT
M	MONSTER 1200S Stripe	1200		2015		R	
M	MONSTER 1200R	1200	112	2016		R	
M	1299 Panigale (ABS Std)	1285		2015		R	
M	1299 Panigale S (ABS Std)	1285		2015		R	
M	1299 Panigale R Final Edition	1285	154	2018		R	
M	1299 Superleggera	1299		2017		R	
GILERA	M NEXUS 500	500		2004		R	
HARLEY DAVIDSON	M Livewire			2020		R	
HONDA	M CBR 1000 RR-R Fireblade SP	1000		2020		R	
	M RCV 213	1000		2015		R	
INDIAN	M FTR 1200	1200		2019		R	
KAWASAKI	M Ninja HR2 Carbon	998		2017		R	
	M NINJA H2R	1000	228	2015		R	
	M NINJA H2	1000	170	2015		R	
	M NINJA H2 CARBON	1000	170	2017		R	
KEEWAY	S Silverblade 125/150/250	125			2007	R	
KTM	M 1190 RC8	1190		2008	2011	R	
	M 1190 RC8 R (ABS Std)	1190		2009		R	
	M SUPERDUKE R 1290 SP Ed.	1290		2017		R	
	M SUPERDUKE R 1290 (ABS Std)	1301	130	2014		R	
	M SUPERDUKE GT 1290	1301	127	2016		R	
	M SUPERDUKE SE 1290	1301		2016		R	
LAVERDA	M TTS 800	800		1999		R	
	M SFC 1000	1000		2003		R	
MALAGUTI	M DRAGON 50 NKD	50		2005		F	
	M SPIDER MAX RS 500/ GT	500		2004		R	
MBK	M SKYLINER 125 / S.E.	125		2001		R	
	M THUNDER 125	125		2001		R	
	M THUNDER 150	150		2001	2002	R	
	M SKYLINER 180	180		2004		R	
MOTO GUZZI	M BREVA 750 IE	750		2003	2011	R	
	M SP 750 NEVADA CLUB / CLASSIC I.E. / Aquila Nera	750		2002		R	
	M V7 Classic	750		2008	2012	R	
	M V7 Cafe Classic	750		2009	2012	R	
	M V7 Racer	750		2010	2011	R	
	M BREVA V 1100	1100		2004		R	
	M CORSARO Avio / Veloce	1200		2010		R	
	M 1200 GT	1200		2010		R	
	M MGS - 01 Corsa	1225		2007		R	
MOTO MORINI	M 9,5	1200		2006		R	
	M Corsaro Veloce / Corsaro 1200 / Corsaro Avio	1200		2005		R	
	M MM3	1200		2007		R	
	M 1200 SPORT	1200		2008		R	
MV AGUSTA	M BRUTALE 675 (B3)	675		2012		R	
	M F3 675	675		2012	2014	R	
	M F3 675 Oro	675		2012		R	
	M F3 675	675		2015		R	
	M F3 675 CIV	675		2015		R	
	M F3 675 WSS	675		2015		R	
	M F3 675 RC	675		2016		R	
	M F3 675 RC Lim.ed.	675	94	2018		R	
	M Brutale 800 RR America	798	103	2018		R	
	M Brutale 800 RR Pirelli	798	103	2018		R	
	M Dragster Rosso	798		2020		R	
	M RVS#1 Lim.ed.	798	103	2018		R	
	M Superveloce 800	798		2020		R	
	M Superveloce Serie Oro 800	798		2020		R	
	M BRUTALE 800 (B31)	800		2012		R	
	M BRUTALE DRAGSTER 800 RR	800		2015		R	
	M BRUTALE DRAGSTER 800	800		2015		R	
	M BRUTALE 800 (B3)	800		2015		R	
	M BRUTALE 800 RR (B3)	800		2015		R	
	M BRUTALE DRAGSTER 800 RR LH44	800		2015		R	
	M BRUTALE 800 (B11)	800		2016		R	
	M BRUTALE DRAGSTER 800 RC	800	103	2017		R	
	M BRUTALE 800 RC	800	81	2019		R	
	M DRAGSTER 800 RC	800	103	2019		R	



		CC	KW	FROM	TO	FRONT / REAR	LEFT / RIGHT
M	DRAGSTER 800 RR	800	103	2019		R	
M	DRAGSTER 800 RR America	800	103	2019		R	
M	DRAGSTER 800 RR LH44	800	103	2019		R	
M	DRAGSTER 800 RR Pirelli	800	103	2019		R	
M	F3 800	800		2014		R	
M	F3 800 RC	800		2016		R	
M	Rivale	800		2013		R	
M	STRADALE 800	800		2015		R	
M	SUPERVELOCE 800	800		2019		R	
M	TURISMO VELOCE 800	800	81	2015		R	
M	TURISMO VELOCE 800 LUSO	800	81	2015		R	
M	TURISMO VELOCE 800 POLIZIA	800		2016		R	
M	TURISMO VELOCE RC	800		2017		R	
M	TURISMO VELOCE 800 Lusso SCS	800	81	2019		R	
M	TURISMO VELOCE 800 RC SCS	800	81	2019		R	
M	Brutale 1000 RR	998		2020		R	
M	Rush 1000	998		2020		R	
M	BRUTALE SERIE ORO 1000	1000	152	2019		R	
PEUGEOT	S Speedfight 3 - RS (50cc L/C - 2T)	50		2009	2012	R	
	S Speedfight 3 (50cc L/C - 2T)	50		2009	2012	R	
	S Speedfight 3 - RS (50cc - A/C -2T)	50		2010	2012	R	
	S Speedfight 4 LC (50cc 2T)	50		2015		R	
	S Speedfight 4 LC (50cc 4T)	50		2015		R	
	S DJANGO 125 (HERITAGE)	125		2014		R	
	S Speedfight 125	125		2013		R	
	S DJANGO 150 (HERITAGE)	150		2014		R	
PIAGGIO	M X9 125	125		2001	2002	F	
	M X9 125	125		2001	2002	R	
	M X9 125 Evolution	125		2004		R	
	M X9 180 AMALFI	180		2001	2003	F	
	M X9 180 AMALFI	180		2001	2003	R	
	M X9 200	200		2002	2003	F	
	M X9 200	200		2002	2003	R	
	M X8 200	200		2004		R	
	M X9 250	250		2000	2003	F	
	M X9 250	250		2000	2003	R	
	S BEVERLY Tourer 400 i.e.	400		2008	2010	F	
	S BEVERLY Tourer 400 i.e.	400		2008	2010	R	
	M BEVERLY 500	500		2002	2005	F	
	M BEVERLY 500	500		2002	2005	R	
	M BEVERLY 500	500		2006	2006	F	
	M BEVERLY CRUISER 500 ie	500		2007	2012	F	
	M BEVERLY CRUISER 500 ie	500		2007	2012	R	
	M X9 500	500		2001	2002	F	
	M X9 500	500		2001	2002	R	
	M X9 500	500		2003		R	
	S X9 500 ie	500		2007		R	
RIEJU	M MRT 50 PRO / SUPERMOTARD / Competizione	50		2008		F	
	M TANGO 50 / TANGO! 50	50		2007		F	
	M MARATHON 125 PRO / SUPERMOTARD	125		2008		F	
	M RS3 125	125		2009		F	
	M SMX 125 / Street	125		2007		F	
	M TANGO 125 / PRO	125		2006	2010	F	
	M TANGO 250	250		2008	2011	F	
SINNIS	S 125 T-8G Ecocity 125	125		2007	2009	R	
	M Grampus 250	250		2010		R	
SUZUKI	S UH 150 BURGMAN (BR11)	150	11	2002	2006	R	
VICTORY	M Empulse TT			2016		R	
YAMAHA	M MAXTER 125	125		2001	2003	R	
	S X-CITY 125	125		2008		R	
	M XQ 125 N MAXSTER	125		2001	2003	R	
	M YP 125 MAJESTY (SE06)	125		2001	2009	R	
	M YP 125 R X-MAX (Brembo Front) NO ABS	125		2006	2009	R	
	S YP 125 R X-MAX (Nissin Front) NO ABS	125		2010	2013	R	
	M MAXTER 150	150		2001	2003	R	
	M YP 150 MAJESTY	150		2001	2003	R	

FDB2075

115.6 x 41.0 x 9.4 mm

MATERIAL AVAILABILITY											
AG	EF	P	PRP	ST	SM	SG	ZR	XRAC	ZRAC	CP1	CPRO
	✓	✓		✓	✓						

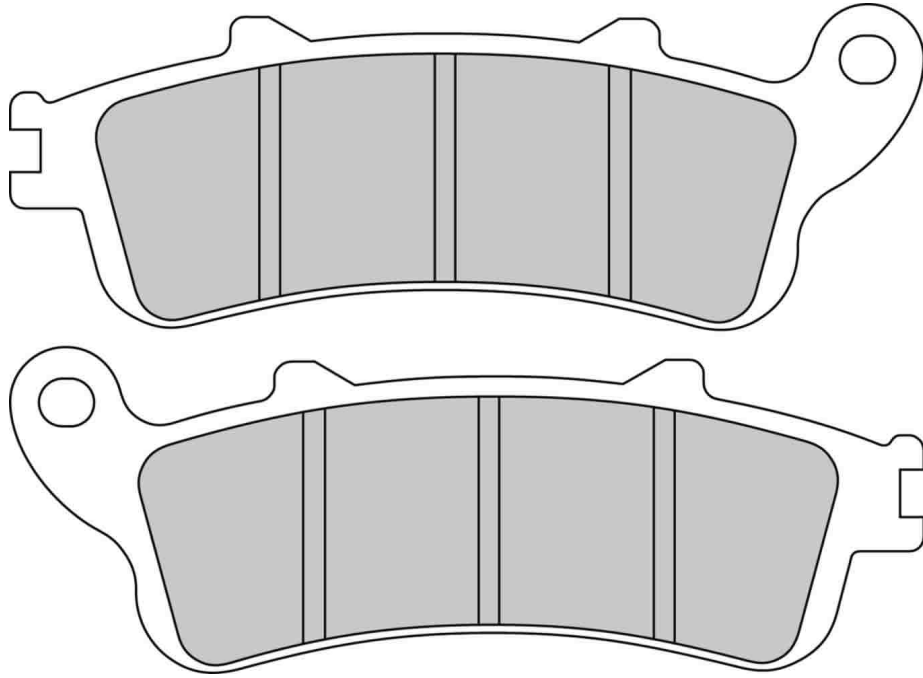

ALSO AVAILABLE		
SHAPE	TH. MM	NOTES
FDB2073	8.0	
FDB2098	8.3	

CROSS REFERENCE	
BRAKING	653
BRAKING	962
BREMBO	07034
BREMBO	07HO52
BREMBO	7034
BRENTA	3023
BRENTA	4023
CL BRAKES	2602
CL BRAKES	3026
EBC	SFA281
GALFER	FD207
GOLD FREN	135
LUCAS/TRW	MCB693
LUCAS/TRW	MCB840
NEWFREN	FD0255
SBS	147
SBS	722
VESRAH	VD-165

		CC	KW	FROM	TO	FRONT / REAR	LEFT / RIGHT
	S FES 125 PANTHEON	125		2000	2006	F	
	S FES 150 PANTHEON	150		2000	2002	F	
	S FES 150 PANTHEON	150		2003	2006	F	
	S FES 250 FORESIGHT	250		1999		F	
	S NSS 250 FORZA (MF04/06)	250		2000	2004	F	
	M XL 1000 V VARADERO	1000		1999	2003	R	
	M XL 1000 VARADERO A4 (ABS)	1000		2004		R	
	M CBR 1100 XX Superblackbird	1100		1996	1997	R	

		CC	KW	FROM	TO	FRONT / REAR	LEFT / RIGHT
	M ST 1100 PAN EUROPEAN ABS/TCS (Dual brake)	1100		1996	2000	R	
	M X 11 1100	1100		2000	2002	R	
	M GOLDWING F6B	1832		2012		R	
	M GOLDWING F6C	1832		2014		R	
	M GL 1800 Gold Wing	1833		2019		R	
	M GL 1800 Gold Wing Tour	1833	93	2019		R	
	M SV 250	250		2001		F	

M = MOTORCYCLE
S = SCOOTER
A = ATV
Sn = SNOWMOBILE

FDB2079

74.0 x 55.1 x 9.0 mm

MATERIAL AVAILABILITY											
AG	EF	P	PRP	ST	SM	SG	ZR	XRAC	ZRAC	CP1	CPRO
	✓	✓		✓				✓	✓	⚠	✓

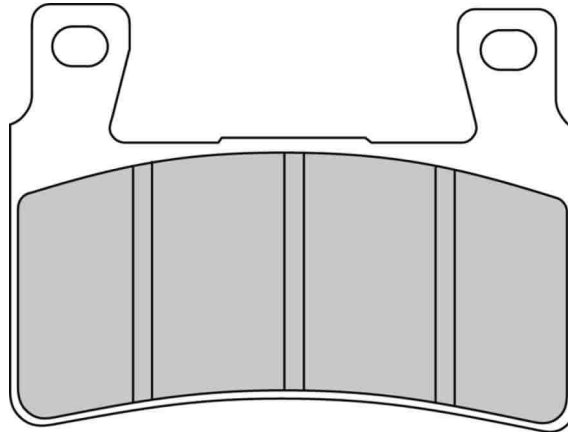

ALSO AVAILABLE		
SHAPE	TH. MM	NOTES
FDB2114	7.1	

CROSS REFERENCE	
BRAKING	827
BRAKING	959
BREMBO	07HD20
BRENTA	3112
BRENTA	4112
CL BRAKES	2711
EBC	FA265
GALFER	FD219
GOLD FREN	134
GOLD FREN	324
LUCAS/TRW	MCB819
NEWFREN	FD0300
SBS	860
VESRAH	VD-166/2

		CC	KW	FROM	TO	FRONT / REAR	LEFT / RIGHT
	HONDA						
	M	CB 400 SUPER FOUR (SF)	400	1999	2003	F	
	M	CBR 600 F4 / F4i Sport	600	1999	2004	F	
	M	CBR 600 FX / FY	600	1999	2000	F	
	M	CBR 600 F1 / F2 / FS1 / FS2 Sport	600	2001	2002	F	
	M	CBR 600 F	600	2007		F	
	M	CBR 600 RR	600	2003	2004	F	
	M	CBR 900 RR-FIREBLADE (SC33)	900	1998	1999	F	
M	CBR 900 RR-FIREBLADE (SC44&50)	900	2000	2003	F		

		CC	KW	FROM	TO	FRONT / REAR	LEFT / RIGHT
							
	M	CBR 929 RR-FIREBLADE	929	2000	2001	F	
	M	VTR 1000 SP-1 (SC45)	1000	2000	2001	F	
	M	VTR 1000 SP-2 (SC45)	1000	2002		F	
	M	CB 1100 EX	1100	2015		F	
	M	CB 1300	1300	2001		F	
KAWASAKI	M	ZX-6R Ninja	636	95	2019	F	
M	ZX 6R 636 NINJA	636		2013		F	

FDB2080

94.5 x 35.8 x 7.3 mm / 119.7 x 26.6 x 6.8 mm

MATERIAL AVAILABILITY											
AG	EF	P	PRP	ST	SM	SG	ZR	XRAC	ZRAC	CP1	CPRO
						✓					

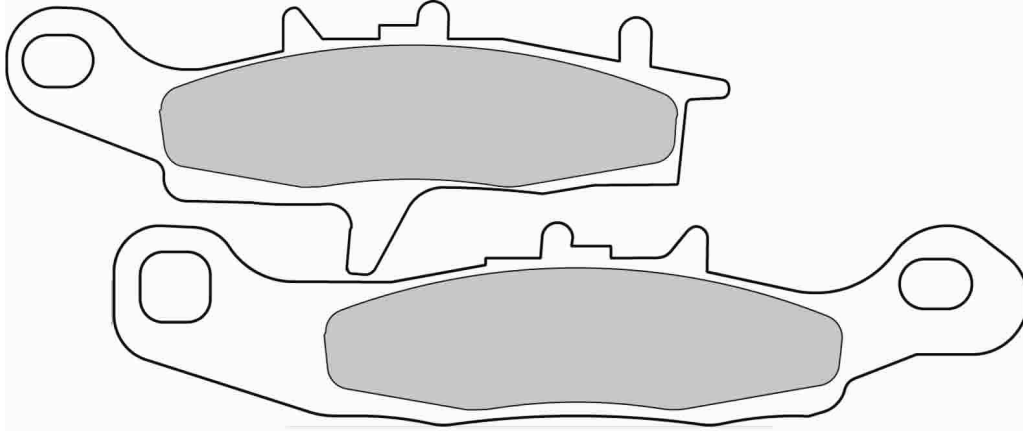

ALSO AVAILABLE		
SHAPE	TH. MM	NOTES
FDB2188		Coupled set

CROSS REFERENCE	
BRAKING	812
BREMBO	07KA22
BREMBO	07KA24
CL BRAKES	2750
EBC	FA258
EBC	FA349
GALFER	FD204
GALFER	FD321
LUCAS/TRW	MCB697
LUCAS/TRW	MCB758
NEWFREN	FD0262
SBS	726
SBS	798
VESRAH	VD-438
VESRAH	VD-442

		CC	KW	FROM	TO	FRONT / REAR	LEFT / RIGHT
	KAWASAKI M	KX 80 R7-T7-W1/2-Y1/2	80	1997	2000	F	
	M	KX 85 / 85-2 A1 / B1	85	2001		F	
	M	KX 100 B7 / C1 / C2 / C3	100	1997	2000	F	
	M	KL 250 SUPER SHERPA	250	2000		F	
	M	KLX 250 H1 SUPER SHERPA	250	1998	1998	F	
KAWASAKI ATV A	KFX 450 R	450		2008	2012	F	right

		CC	KW	FROM	TO	FRONT / REAR	LEFT / RIGHT
	A	KVF 650 PRAIRIE	650	2002	2003	F	right
	A	KVF 650 BRUTE FORCE	650	2005	2007	F	right
	A	KFX 700	700	2004	2009	F	right
SUZUKI M	RM 85 L	85	2005		F		
TVS M	Fiero F2	150		2003	2006	F	

M = MOTORCYCLE
S = SCOOTER
A = ATV
Sn = SNOWMOBILE

FDB2081

39.8 x 56.7 x 8.0 mm

replacing FDB705

MATERIAL AVAILABILITY											
AG	EF	P	PRP	ST	SM	SG	ZR	XRAC	ZRAC	CP1	CPRO
✓											

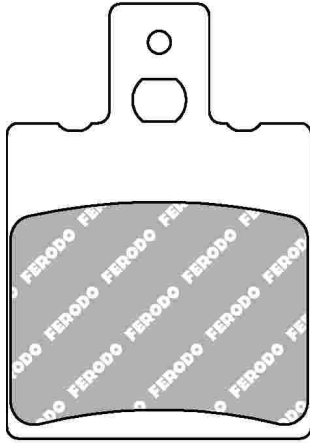

CROSS REFERENCE	
BRAKING	778
BREMBO	07BB31
BREMBO	7087
BRENTA	3067
BRENTA	4067
GALFER	FD232
LUCAS/TRW	MCB708
NEWFREN	FD0263
SBS	149
VESRAH	VD-911/4
VESRAH	VD-977

		CC	KW	FROM	TO	FRONT REAR	LEFT RIGHT		
	APRILIA	M	LEONARDO 125	125		1997	1998	F	
		M	LEONARDO	150		1997	1998	F	
	BENELLI	M	125 JARNO	125		1989		R	
	BETA	M	EIKON 125	125		1999		F	
		M	EIKON 150	150		1999		F	

		CC	KW	FROM	TO	FRONT REAR	LEFT RIGHT		
	MALAGUTI	M	MEX 50 ENDURO	50		1985		F	
		M	MDX 80 ENDURO	80		1984		F	
		M	CIAK 125	125		2001		F	
		M	CIAK 150	150		2001		F	

FDB2083

99.8 x 31.0 x 9.0 mm

September 2017: AG superseded by EF

MATERIAL AVAILABILITY											
AG	EF	P	PRP	ST	SM	SG	ZR	XRAC	ZRAC	CP1	CPRO
X	✓	✓		✓	✓						

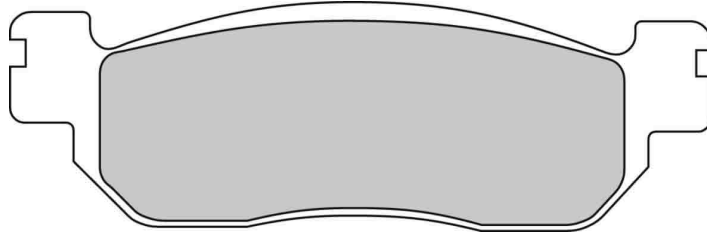

CROSS REFERENCE	
BRAKING	822
BREMBO	07043
BREMBO	07YA37
BREMBO	7043
BRENTA	3022
BRENTA	4022
CL BRAKES	2828
CL BRAKES	3033
EBC	FA275
GALFER	FD214
GOLD FREN	146
LUCAS/TRW	MCB699
NEWFREN	FD0259
SBS	155
SBS	728
VESRAH	VD-263
VESRAH	VD-265

		CC	KW	FROM	TO	FRONT REAR	LEFT RIGHT
	AKT	M	Komfort	115			F
	ITALJET	M	JUPITER 125	125	2001		R
		M	JUPITER 250	250	2001		R
	LINHAI	M	Monarch 125 T	125	2006		R
		M	Monarch 150 T	150	2006		R
		M	Main Street 300 (Scooter)	300	2007		R
	MBK	M	SKYLINER 250	250	2000	2002	R
	YAMAHA	M	105 CRIPTON	105	1996	1998	F
		M	TW 125	125	1998	2002	F
		M	TW 125	125	2003		F
		S	YP 125 RA X-MAX (Nissin Front) (39D2) ABS	125	2011		R
		S	YP125RA X-MAX IRON MAX ABS	125	2016		R
		M	BRONCO 225	225	1997		F
		M	CELLOW 225	225	1997		F

		CC	KW	FROM	TO	FRONT REAR	LEFT RIGHT
	M	SEROW 250 (3C51/52)	250		2005		F
	S	X-CITY 250	250		2008		R
	M	XG 250 TRICKER (5XT1)	250		2004	2006	F
	M	X-Max 250 (SG16) - No ABS	250	15	2005	2009	R
	M	X-Max 250 (SG16) - No ABS	250	16	2007	2009	R
	S	X-Max 250 (SG22)	250	15	2010	2013	R
	S	X-Max 250 ABS (SG22)	250	15	2011		R
	S	X-Max IRON MAX ABS	250		2016		R
	M	XT 250 X	250		2006	2008	F
	M	YP 250 A MAJESTY	250		2000		R
	M	YP 250 MAJESTY DX - ABS	250		1998	1999	R
	S	X-Max 300 Iron Max	300	20	2019		R
	M	YZF 600 R6	600		1999	2002	R
	M	YZF 1000 R1	1000		2002	2003	R

M = MOTORCYCLE
S = SCOOTER
A = ATV
Sn = SNOWMOBILE

FDB2084

51.9 x 59.8 x 8.6 mm

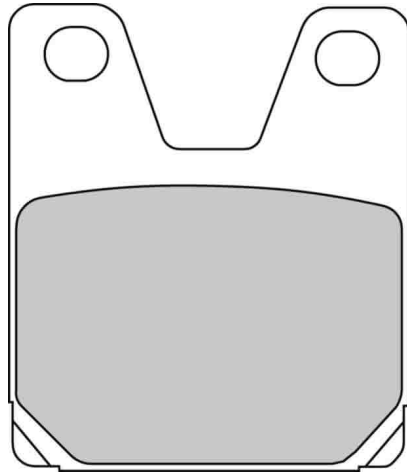

MATERIAL AVAILABILITY											
AG	EF	P	PRP	ST	SM	SG	ZR	XRAC	ZRAC	CP1	CPRO
		✓		✓							

CROSS REFERENCE	
BRAKING	826
BREMBO	07YA38
CL BRAKES	2713
EBC	FA267
GALFER	FD218
LUCAS/TRW	MCB702
NEWFREN	FD0261
SBS	733
VESRAH	VD-264

		CC	KW	FROM	TO	FRONT / REAR	LEFT / RIGHT	
	YAMAHA	M	YZF 750 R7 (OW02)	750		1999	2001	R

		CC	KW	FROM	TO	FRONT / REAR	LEFT / RIGHT
	M	YZF 1000 R1	1000		1998	2001	R

FDB2085

44.8 x 53.5 x 8.6 mm

January 2017: AG compound superseded by EF (Set=4 Pads)

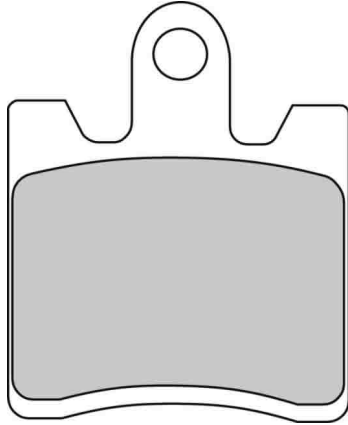

MATERIAL AVAILABILITY											
AG	EF	P	PRP	ST	SM	SG	ZR	XRAC	ZRAC	CP1	CPRO
✗	✓	✓		✓	✓						

CROSS REFERENCE	
BRAKING	830
BREMBO	07037
BREMBO	07YA09
BREMBO	7037
BRENTA	3018
BRENTA	4018
CL BRAKES	1175
CL BRAKES	3049
EBC	FA283
EBC	FA423/4HH
EBC	SFA283
GALFER	FD222
GALFER	FD372
GOLD FREN	147
LUCAS/TRW	MCB706
NEWFREN	FD0264
SBS	146
SBS	740
VESRAH	VD-353

		CC	KW	FROM	TO	FRONT REAR	LEFT RIGHT
	KAWASAKI	M	SC 250 EPSILON	250		2002	F
	SUZUKI	M	AN 250 BURGMAN K1/K2	250		2001 2002	F
		M	AN 250 K3-K6 BURGMAN (CJ43A)	250		2003 2006	F
		M	AN 250 BURGMAN W/X/Y	250		1996 2002	F
		M	SKY WAVE 250 (type II)	250		1998	F
		M	AN 400 BURGMAN	400		1999 2000	F
		M	AN 400 BURGMAN	400		2001 2006	F
	SYM	S	Joymax 125 i GTS Sport	125		2016	F
		S	Joymax 250 i GTS Sport	250		2016	F

		CC	KW	FROM	TO	FRONT REAR	LEFT RIGHT
	S	Joymax 300 i GTS Sport	300		2016	F	
	M	GT 500	500		2004	F	
	TRIUMPH	M	TROPHY SE	1215		2012	F
	YAMAHA	M	FJR 1300A (ABS - 4 pad Front caliper)	1300		2006	F
		M	FJR 1300AS (ABS - Electric gearshift)	1300		2006	F
		M	FJR 1300AE (ABS - Electronic suspension adj)	1300		2015	F
		M	XV 1900 A Midnight Star	1900		2013	F
		M	XV 1900 A CFD	1900		2014	F

M = MOTORCYCLE
S = SCOOTER
A = ATV
Sn = SNOWMOBILE

FDB2086

81.4 x 42.2 x 8.3 mm

MATERIAL AVAILABILITY											
AG	EF	P	PRP	ST	SM	SG	ZR	XRAC	ZRAC	CP1	CPRO
	✓	✓									

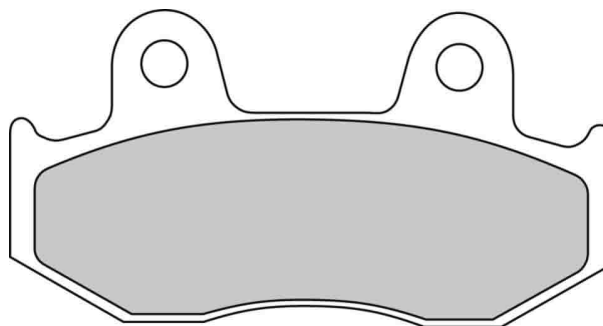

ALSO AVAILABLE		
SHAPE	TH. MM	NOTES
FDB382	7.5	
FDB2119	9.0	
FDB2132	8.3	pin on the backplate

CROSS REFERENCE	
BREMBO	07038
BREMBO	7038
COBREQ	N-909
EBC	SFA323/3
FRAS-LE	PD/852
GALFER	FD400
GOLD FREN	102
NEWFREN	FD0265
SBS	174
VESRAH	VD-134
VESRAH	VD-134/3
VESRAH	VD-136

		CC	KW	FROM	TO	FRONT / REAR	LEFT / RIGHT
SUZUKI	M AN 250 BURGMAN W/X/Y	250		1996	2002	R	
	M SKY WAVE 250 (type II)	250		1998		R	

		CC	KW	FROM	TO	FRONT / REAR	LEFT / RIGHT
M	AN 400 BURGMAN	400		1999	2000	R	

FDB2087

96.8 x 42.2 x 8.8 mm / 76.5 x 42.2 x 8.8 mm

May 2016: AG superseded by EF

MATERIAL AVAILABILITY											
AG	EF	P	PRP	ST	SM	SG	ZR	XRAC	ZRAC	CP1	CPRO
✗	✓										

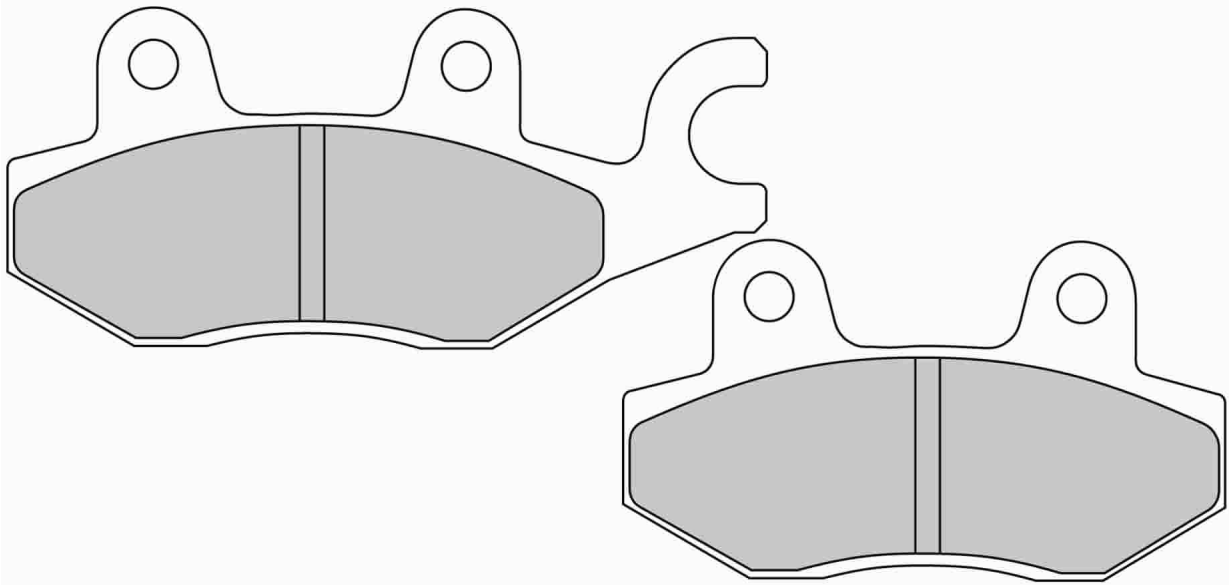

ALSO AVAILABLE		
SHAPE	TH. MM	NOTES
FDB631	7.6	Without slot

CROSS REFERENCE	
BREMBO	07033
BREMBO	7033
BRENTA	3021
BRENTA	4021
EBC	FA197
GALFER	FD145
GOLD FREN	332
LUCAS/TRW	MCB663
NEWFREN	FD0257
SBS	119
SBS	638
VESRAH	VD-250/2
VESRAH	VD-252/2
VESRAH	VD-9042

		CC	KW	FROM	TO	FRONT REAR	LEFT RIGHT
AKT	M Flex Ultra					F	
	M AK 125 R3	125				F	
	M TT 125	125				F	
	M AK 150 R3	150				F	
	M TT 150	150				F	
HERO	M CR5	180				F	
	M AK 235 R	235				R	
	M Maestro	109	6	2016		F	
	M CBZ	150		1999	2006	F	
	M Karizma	220		2003		F	
	M Karizma ZMR	220		2003		F	
	M Karizma R	223	12	2003		F	
	M Karizma ZMR	223	13	2009		F	
	M Karizma R	223	15	2014		F	
	M Karizma ZMR	223	15	2014		F	

		CC	KW	FROM	TO	FRONT REAR	LEFT RIGHT
	M Karizma	223	14	2016		F	
	M Karizma ZMR	223	15	2016		F	
HONDA	M NSR 75 (NS-1)	75		1992	2000	F	
KEEWAY	S RKS 125	125		2012		F	
	S Silverblade 125	125		2010	2011	F	
	S Silverblade 125	125		2010	2011	R	
	S 125i Silverblade	125		2013		R	
	M RKS 150	150		2012		F	
KSR MOTO BY GENERIC	M RKS 200	200		2012		F	
	S 250i Silverblade	250		2013		R	
	M Work 125/150 (4T)	125		2012		F	
	S 50	50		2005	2006	F	
KYMCO	M BET & WIN 50	50		2002	2006	F	
	M DINK / GRAND DINK 50 / New Dink	50		1997		F	
	S DINK 50 (4T)	50		2007		F	

M = MOTORCYCLE
S = SCOOTER
A = ATV
Sn = SNOWMOBILE



		CC	KW	FROM	TO	FRONT / REAR	LEFT / RIGHT
S	GRAND DINK 50 (2T)	50		2004	2007	F	
S	G-DINK 50 (2T)	50		2012		F	
S	JETIX 50	50		2010	2010	R	
S	SENTO 50	50		2008	2009	F	
M	SPACER 50	50		1999		F	
M	SUPER 9 50 LC / SUPER 9 S	50		2000		F	
M	TOP BOY 50	50		1997	2000	F	
M	TOP BOY 100	100		1997		F	
M	LIBERO 111 4T	111		2008		F	
S	ACTIV 110 / 125	125		2004	2006	F	
S	AGILITY 125 R16 +	125	7	2015		R	
S	AGILITY Carry 125 (4T) EURO4	125		2017		R	
S	AGILITY City +125 i CBS	125	6	2019		R	
M	B & W 125 BET & WIN Dinksport	125		2000		F	
M	B & W 125 BET & WIN Dinksport	125		2000		R	
M	CK1 125	125		2014		F	
M	DINK / GRAND DINK 125 /New Dink	125		1997		F	
M	DINK / GRAND DINK 125 /New Dink	125		1997		R	
S	DINK 125 (4T)	125		2006		F	
S	DINK 125 (4T)	125		2006		R	
M	EGO 125	125		2001	2003	F	
M	EGO 125	125		2001	2003	R	
S	GRAND DINK 125 (4T)	125		2001	2007	F	
S	GRAND DINK 125 (4T)	125		2001	2007	R	
M	HIPSTER 125	125		1999		F	
S	JETIX 125	125		2010	2010	R	
M	KR 125 QUANNON SPORT	125		2007	2013	F	
M	KR 125 QUANNON SPORT	125		2007	2013	R	
M	KR 125 QUANNON NAKED	125		2010		F	
M	KR 125 QUANNON NAKED	125		2010		R	
M	K-PIPE 125	125		2012	2013	F	
S	MOVIE XL 125	125		2001	2009	F	
M	SECTOR 125	125		1998	2001	F	
M	SPACER 125	125		1998		F	
M	SPACER 125	125		1998		R	
M	SPIKE 125	125		2004		F	
M	SPIKE 125	125		2004		R	
S	Visar 125 i CBS	125	7	2019		R	
M	YAGER 125	125		2001		F	
M	YAGER 125	125		2001		R	
M	ZING 125 / ZING II 125	125		1997	2013	F	
S	AGILITY CITY 150 R16	150		2008	2012	R	
M	B & W 150 BET & WIN	150		2000		F	
M	B & W 150 BET & WIN	150		2000		R	
S	DINK 150	150		1997	2004	F	



		CC	KW	FROM	TO	FRONT / REAR	LEFT / RIGHT
S	DINK 150	150		1997	2004	R	
S	GRAND DINK 150	150		2001	2007	F	
S	GRAND DINK 150	150		2001	2007	R	
M	HIPSTER 150	150		1999		F	
S	MOVIE XL 150	150		2001	2009	F	
M	SPACER 150	150		2003		F	
M	SPACER 150	150		2003		R	
M	YAGER 150	150		2001		F	
S	AGILITY 200 i R16	200	8	2010		R	
S	AGILITY 200 i R16 +	200		2015		R	
S	DINK 200i	200		2006		F	
S	DINK 200i	200		2006		R	
M	SPACER	200		2004		F	
M	SPACER	200		2004		R	
M	YAGER 200i	200		2007	2013	F	
M	YAGER 200i	200		2007	2013	R	
M	B & W 250 BET & WIN	250		2000		F	
M	B & W 250 BET & WIN	250		2000		R	
M	EGO 250	250		2001		F	
M	EGO 250	250		2001		R	
S	PEOPLE 250	250		2003	2005	F	
M	YUP 250	250		2003		F	
M	YUP 250	250		2003		R	
PEUGEOT	S WTR 125	125		2008	2008	F	
PGO	S G-Max 125	125		2006	2008	R	
S	G-Max 125 (Wave disc)	125		2009	2012	R	
S	G-Max 250	250		2006	2008	R	
SINNIS	M QM 125- 2 D Stealth 125	125		2008	2010	F	right
M	Grampus 250	250		2010		F	
SUZUKI	M ADDRESS 125	125		2008		F	
SYM	S X'Pro 50	50		2013		F	
S	Euro MX 125 (HF12W3-6 Euro 2) (Rear disc model)	125		2006	2009	R	
M	SHARK 4 VR 125	125		2000	2002	R	
M	XS 125 K	125		2007		F	
M	SHARK 4 VR 150	150		2000	2002	R	
TVS	M Rockz	125				F	
M	Stryker	125				F	
M	Apache 150	147	10	2005		F	
M	Apache	150		2006	2008	F	
M	Apache RTR 160	159	11	2015		F	
M	Apache	160		2008		F	
M	Apache RTR 160 Hyper Edge	160	11	2010		F	
M	Apache RTR	180		2009		F	
M	Apache RTR	200				F	

FDB2090

51.1 x 53.5 x 9.5 mm

July 2016: AG compound superseded by EF

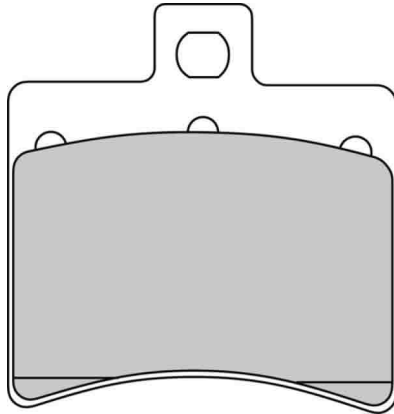

MATERIAL AVAILABILITY											
AG	EF	P	PRP	ST	SM	SG	ZR	XRAC	ZRAC	CP1	CPRO
✗	✓	✓									

CROSS REFERENCE	
BRAKING	840
BREMBO	07020
BREMBO	7020
BRENTA	3020
BRENTA	4020
EBC	FA298
GALFER	FD228
GOLD FREN	150
LUCAS/TRW	MCB710
NEWFREN	FD0267
SBS	152
SBS	747
VESRAH	VD-974

		CC	KW	FROM	TO	FRONT REAR	LEFT RIGHT
	APRILIA	S SR 50 2000	50	2000		R	
	S SR STREET 50	50	2003		R		
	S SR 50 FACTORY	50	2004		R		
	S SR 50 R	50	2008		F		
	S SR 50 R	50	2008		R		
	S ATLANTIC (ARECIFE) 125	125	2003		R		
	S ATLANTIC 125	125	2010		R		
	M RS 125 2T RADIAL CALIPER	125	2006	2012	R		
	S SCARABEO 125	125	1998	2006	R		
	S SCARABEO 125 Street	125	2007		R		
	S SCARABEO 125 GT	125	2002	2003	R		
	S SCARABEO 125 GT	125	2004		R		
	M SPORTCITY 125 ie	125	2004		R		
	S Sport City Cube 125	125	2008	2012	R		
	S SCARABEO 150	150	1998		R		
	S SCARABEO 150 GT	150	2004		R		
	S ATLANTIC (ARECIFE) 200	200	2003	2007	R		
	S SCARABEO 200	200	2001	2007	R		
	S SCARABEO 200 GT	200	2002		R		
	S SCARABEO 200 / Class	200	2008		R		
	S SCARABEO 200 i.e.	200	2009		R		
	M SPORTCITY 200	200	2004		R		
	S Sport City Cube 200	200	2008	2009	R		
	S ATLANTIC 250	250	2008		R		
	M LEONARDO 250	250	1999		R		
	S SCARABEO 250	250	2004	2006	R		
	S SCARABEO 250 ie	250	2007		R		
	M SPORTCITY 250 ie	250	2007		R		
	S ATLANTIC 300	300	2010		R		
	M LEONARDO 300	300	2004		R		
	S SCARABEO 300 Class / Special	300	2010		R		
	M SPORTCITY 300 / Cube Black line	300	2008		R		
S ATLANTIC Sprint 400	400	2007		R			
S SCARABEO 400 ie	400	2007		R			

		CC	KW	FROM	TO	FRONT REAR	LEFT RIGHT
	BENELLI	S ATLANTIC (ARECIFE) 500	500	2001		R	
	S ATLANTIC Sprint 500	500	2007		R		
	S SCARABEO 500	500	2003		R		
	S SCARABEO 500	500	2008		R		
	S SCARABEO 500 Class	500	2010		R		
	M Velvet 125 (13" Front Wheel/Touring)	125	2008	2012	R		
	M Velvet 150 (13" Front Wheel/Touring)	150	2008	2012	R		
	M BN 251	250	2015		R		
	M VELVET 250	250	1999		R		
	BETA	M EIKON 125	125	1999		R	
M EIKON 150	150	1999		R			
HYOSUNG	M GD 250 N	250	2013		R		
M GD 250 R	250	2015		R			
M GT 250 i (Naked)	250	2013		R			
M GT 250 R (Inj)	250	2014		R			
M GT 250 P	250	2015		R			
M GT 300 R	300	2016		R			
M GV 300	300	2016		R			
M GD 450	450	2016		R			
M GT 650 i R	650	2014		R			
M GT 650 P	650	2016		R			
KEEWAY	S Cityblade 125	125	2013		R		
M RKV 125	125	2010	2015	R			
M TX 125 SM (17" F/Wheel)	125	2013		R			
M RKV 150	150	2013	2015	R			
M RKX 150	150	2013	2014	R			
M KXM 200	200	2014		R			
M KXV 200	200	2014		R			
M RKV 200 S	200	2014		R			
M RKV 200 S Factory	200	2014		R			
M RKX 200	200	2013		R			
M TX200 (19" F/Wheel)	200	2013		R			
KSR MOTO BY GENERIC	M Code S 125/150/200 (4T)	125	2012	2015	R		
M Code X 125/150/200 (4T)	125	2012	2014	R			

M = MOTORCYCLE
S = SCOOTER
A = ATV
Sn = SNOWMOBILE

		CC	KW	FROM	TO	FRONT / RÉAR	LEFT / RIGHT
	MALAGUTI						
M	MADISON 125	125		1999	2003	R	
M	MADISON 3 - 125	125		2006		R	
M	PHANTOM MAX 125	125		2004		R	
M	MADISON 150	150		1999	2003	R	
M	MADISON 180	180		1999	2003	R	
M	MADISON S 200	200		2004		R	
M	PHANTOM MAX 200	200		2004		R	

		CC	KW	FROM	TO	FRONT / RÉAR	LEFT / RIGHT
							
M	MADISON 250	250		1999	2003	R	
M	MADISON 3 250 RS	250		2004		R	
M	PASSWORD 250	250		2005		R	
M	PHANTOM MAX 250	250		2006		R	
M	MADISON K 400	400		2002		R	
TGB	S Bellavita125 i (4T)	125		2012		R	
	S Bellavita300 i (4T)	300		2012		R	

FDB2091

79.7 x 43.9 x 10.3 mm

MATERIAL AVAILABILITY

AG	EF	P	PRP	ST	SM	SG	ZR	XRAC	ZRAC	CP1	CPRO
		✓									

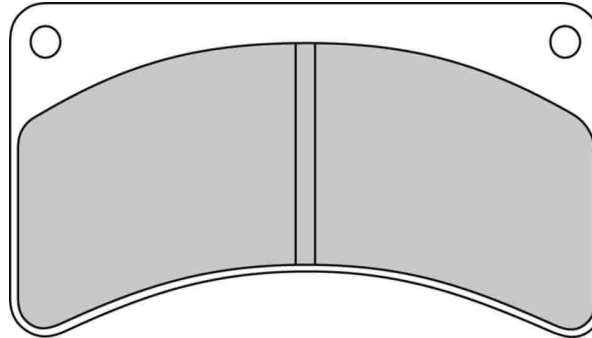

Pinze / Calipers

Kelgate

6-Piston

4190

FDB2095

54.0 x 50.7 x 8.1 mm

July 2016: AG compound superseded by EF

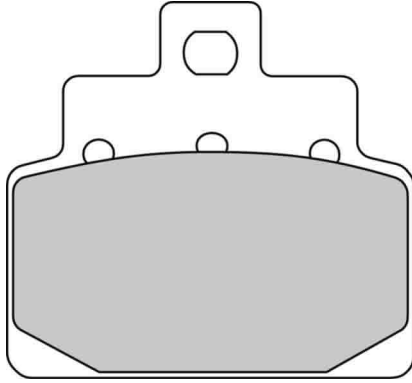

MATERIAL AVAILABILITY											
AG	EF	P	PRP	ST	SM	SG	ZR	XRAC	ZRAC	CP1	CPRO
X	✓										

CROSS REFERENCE	
BRAKING	842
BREMBO	07021
BREMBO	7021
BRENTA	3028
BRENTA	4028
EBC	FA301
EBC	SFA301
GALFER	FD234
GOLD FREN	170
LUCAS/TRW	MCB709
NEWFREN	FD0271
SBS	153
SBS	748
VESRAH	VD-976

		CC	KW	FROM	TO	FRONT REAR	LEFT RIGHT
	S SCARABEO 100 (Minarelli engine)	100		2000		F	
	S SCARABEO 100 (Yamaha engine)	100		2000		F	
	S SCARABEO 100 4T	100		2001	2004	F	
	S SCARABEO 100 Net	100		2010		F	
	M HABANA 125 all models	125		1999		F	
M LEONARDO 125	125		1999	2006	F		

		CC	KW	FROM	TO	FRONT REAR	LEFT RIGHT
	M LEONARDO 125	125		1999	2006	R	
	S SR 125	125		1999	2002	F	
	M LEONARDO	150		1999	2004	F	
	M LEONARDO	150		1999	2004	R	
	S SR 150	150		1999	2002	F	

M = MOTORCYCLE
S = SCOOTER
A = ATV
Sn = SNOWMOBILE

FDB2096

85.0 x 43.0 x 8.5 mm / 64.0 x 36.8 x 10.9 mm

August 2017: AG superseded by EF

MATERIAL AVAILABILITY											
AG	EF	P	PRP	ST	SM	SG	ZR	XRAC	ZRAC	CP1	CPR0
X	✓					✓					

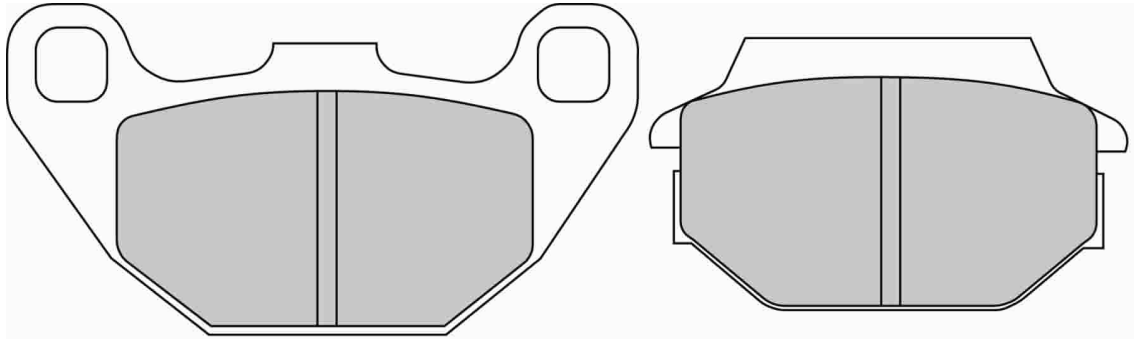

CROSS REFERENCE	
BRAKING	869
BREMBO	07022
BREMBO	7022
BRENTA	3049
BRENTA	3050
BRENTA	3051
BRENTA	4049
BRENTA	4050
BRENTA	4051
CL BRAKES	1153
EBC	FA305
GALFER	FD261
GOLD FREN	183
LUCAS/TRW	MCB712
NEWFREN	FD0269
SBS	154
SBS	749
VESRAH	VD-995

		CC	KW	FROM	TO	FRONT / REAR	LEFT / RIGHT	
	ARCTIC CAT	A 50 DVX (4T)	50	2006	2008	R		
		A 50 Utility	50	2006	2008	R		
		A 90 DVX	90	2006	2010	R		
		A 90 DVX SE	90	2009		R		
		A 90 Reverse Gear Model	90	2010	2012	R		
		A 90 Utility (2 x 4)	90	2006	2010	R		
		A 150 Utility 2x4	150	2009	2010	R		
	KAWASAKI ATV	A KFX 50 / KSF 50	50	2007	2009	R		
		A KFX 90 / KSF 90	90	2007	2010	R		
KYMCO	S	AGILITY CITY 50 R16 (4T/2T)	50	2008		F		
	S	AGILITY Carry 50 (4T)	50	2011	2018	F		
	S	AGILITY 50 R16 + (2T)	50	2015		F		
	S	AGILITY 50 R16 + (4T)	50	2015		F		
	S	DJS 50	50	2012	2013	F		
	S	PEOPLE 50 (2T)	50	1999	2011	F		
	S	PEOPLE S 50 (2T)	50	2005	2010	F		
	S	PEOPLE S 50 ELEGANCE (4T)	50	2006	2013	F		
	M	SUPER 9 50 LC / SUPER 9 S	50	2000		R		
	S	SUPER 8 50 2T/4T	50	2007		F		
	S	AGILITY CITY 125 R16	125	7	2008		F	
	S	AGILITY RS 125 R12 (2T)	125		2009	2013	F	
	S	AGILITY Carry 125 (4T)	125		2011	2016	F	
	S	PEOPLE 125	125	7	1999	2005	F	
	S	PEOPLE S 125	125		2005	2006	F	
	M	PEOPLE / PEOPLE S 125	125		2006		F	
S	PEOPLE S 125 DD	125		2007		F		

		CC	KW	FROM	TO	FRONT / REAR	LEFT / RIGHT	
	S	PEOPLE ONE 125i	125		2013	2014	F	
	S	SUPER 8 125	125		2008	2013	F	
	S	AGILITY CITY 150 R16	150		2008	2012	F	
	M	PEOPLE 150	150		1999		F	
	S	Super 8	150		2007	2014	F	
	S	AGILITY 200 i R16	200	8	2010		F	
	S	AGILITY 200 i R16 +	200		2015		F	
	S	PEOPLE S 200	200		2004	2010	F	
	S	PEOPLE S 200 i	200		2007		F	
	KYMCO ATV	A	Mongoose 50 (4T) (Rear disc model)	50		2008	2009	R
		A	MXer 50	50		2000	2007	R
		A	MXU 50	50		2005	2013	R
		A	Mongoose 70 (4T)	70		2007	2009	R
		A	KXR 90 MONGOOSE	90		2002	2010	R
A		MAXXER 90	90		2005	2006	R	
	A	MXer 90	90		2004		R	
	A	MXU 150	150		2005	2012	R	
LAVERDA	M	PHOENIX 125 / 150 / 200	125		2001		R	
SYM	S	ComBiz 125	125		2011		F	
	M	HD 125	125		2004	2007	F	
	S	JETV (125cc/4T)	125		2012	2013	F	
	M	JOYRIDE 125	125		2001	2005	R	
	M	JOYRIDE 150	150		2001		R	
	M	HD 200	200		2004	2005	F	
M	JOYRIDE 200	200		2001		R		

FDB2097

98.1 x 65.0 x 8.1 mm

MATERIAL AVAILABILITY

AG	EF	P	PRP	ST	SM	SG	ZR	XRAC	ZRAC	CP1	CPRO
		✓	✓	✓							

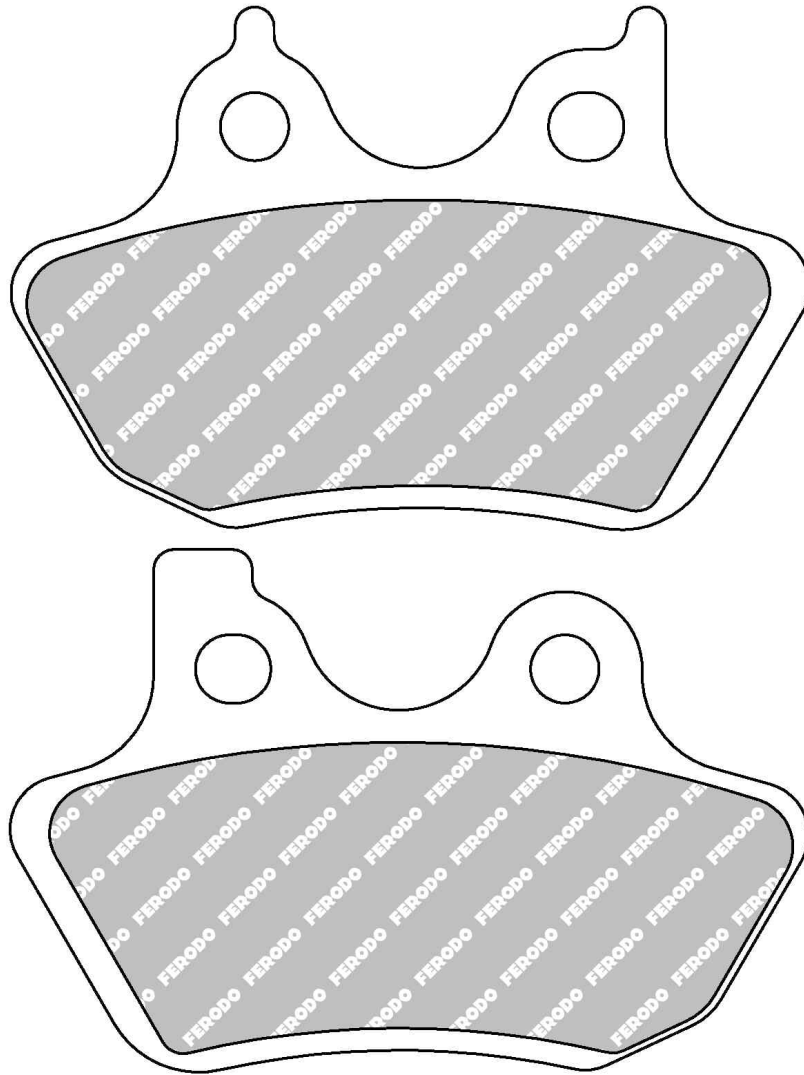

CROSS REFERENCE

BREMBO	07HD12
BREMBO	07HD16
BRENTA	4165
CL BRAKES	2958
EBC	FA400
GALFER	FD235
GALFER	FD375
GALFER	FD376
LUCAS/TRW	MCB711
NEWFREN	FD0290
SBS	750
SBS	826
VESRAH	VD-9022

		CC	KW	FROM	TO	FRONT / REAR	LEFT / RIGHT
	M XL53C Sportster Custom	883		2000	2003	F	
	M XL53C Sportster Custom	883		2000	2003	R	
	M XL 883 R Sportster	883		2000	2003	F	
	M XL 883 R Sportster	883		2000	2003	R	
	M XL 883 R 100th Anniversary Edition	883		2003	2003	F	
	M XL 883 R 100th Anniversary Edition	883		2003	2003	R	
	M XLH 883 Sportster	883		2000	2003	F	
	M XLH 883 Sportster	883		2000	2003	R	

		CC	KW	FROM	TO	FRONT / REAR	LEFT / RIGHT
	M XLH 883 Sportster Hugger	883		2000	2003	F	
	M XLH 883 Sportster Hugger	883		2000	2003	R	
	M VRSC V-Rod	1130		2000	2005	F	
	M VRSC V-Rod	1130		2000	2005	R	
	M XL 1200 C Sportster Custom	1200		2000	2003	F	
	M XL 1200 C Sportster Custom	1200		2000	2003	R	
	M XL 1200 S Sportster Sport	1200		2000	2003	F	
	M XL 1200 S Sportster Sport	1200		2000	2003	R	

M = MOTORCYCLE
S = SCOOTER
A = ATV
Sn = SNOWMOBILE



		CC	KW	FROM	TO	FRONT / REAR	LEFT / RIGHT
M	XLH 1200 Sporter	1200		2000	2003	F	
M	XLH 1200 Sporter	1200		2000	2003	R	
M	FLHR Road King	1450		2000	2006	F	
M	FLHR Road King	1450		2000	2006	R	
M	FLHRCl Road King Classic	1450		2000	2006	F	
M	FLHRCl Road King Classic	1450		2000	2006	R	
M	FLHRI Road King	1450		2000	2006	F	
M	FLHRI Road King	1450		2000	2006	R	
M	FLHRS/FLHRSI Road King Custom	1450		2004	2006	F	
M	FLHRS/FLHRSI Road King Custom	1450		2004	2006	R	
M	FLHT/FLHTi Electra Glide Standard	1450		2000	2006	F	
M	FLHT/FLHTi Electra Glide Standard	1450		2000	2006	R	
M	FLHTCi Electra Glide Classic	1450		2000	2006	F	
M	FLHTCi Electra Glide Classic	1450		2000	2006	R	
M	FLHTCU-I Ultra Classic Electra Glide	1450		2000	2006	F	
M	FLHTCU-I Ultra Classic Electra Glide	1450		2000	2006	R	
M	FLHTC Electra Glide Classic	1450		2000	2005	F	
M	FLHTC Electra Glide Classic	1450		2000	2005	R	
M	FLHX/FLHXi Street Glide	1450		2006	2006	F	
M	FLHX/FLHXi Street Glide	1450		2006	2006	R	
M	FLST/FLSTi Heritage Softail	1450		2006		F	
M	FLST/FLSTi Heritage Softail	1450		2006		R	
M	FLSTC Heritage Softail Classic	1450		2000	2006	F	
M	FLSTC Heritage Softail Classic	1450		2000	2006	R	
M	FLSTCi Heritage Softail Classic	1450		2001	2006	F	
M	FLSTCi Heritage Softail Classic	1450		2001	2006	R	
M	FLSTF Fat Boy	1450		2000	2006	F	
M	FLSTF Fat Boy	1450		2000	2006	R	
M	FLSTFi Fat Boy	1450		2001	2006	F	
M	FLSTFi Fat Boy	1450		2001	2006	R	
M	FLSTFi Fat Boy 15th Anniversary Edition	1450		2005	2005	F	
M	FLSTFi Fat Boy 15th Anniversary Edition	1450		2005	2005	R	
M	FLSTN/FLSTNi Softail Deluxe	1450		2005	2006	F	
M	FLSTN/FLSTNi Softail Deluxe	1450		2005	2006	R	
M	FLSTS/I Heritage Springer	1450		2000	2003	R	
M	FLSTSC/FLSTSCi Springer Classic	1450		2005	2007	R	
M	FLTR Road Glide	1450		2000	2004	F	
M	FLTR Road Glide	1450		2000	2004	R	
M	FLTR-i Road Glide	1450		2000	2006	F	
M	FLTR-i Road Glide	1450		2000	2006	R	
M	FXD Super Glide	1450		2000	2003	F	
M	FXD Super Glide	1450		2000	2003	R	
M	FXDi Super Glide	1450		2004	2005	F	
M	FXDi Super Glide	1450		2004	2005	R	
M	FXDi Super Glide (Cast wheel)	1450		2006	2007	F	
M	FXDi Super Glide (Cast wheel)	1450		2006	2007	R	
M	FXDi 35 35th Anniv. Super Glide (Spoke wheels)	1450		2006	2006	F	
M	FXDi 35 35th Anniv. Super Glide (Spoke wheels)	1450		2006	2006	R	
M	FXDBi Street Bob (Spoke wheel)	1450		2006	2006	F	
M	FXDBi Street Bob (Spoke wheel)	1450		2006	2006	R	
M	FXDC/I Dyna Super Glide Custom	1450		2005	2006	F	
M	FXDC/I Dyna Super Glide Custom	1450		2005	2006	R	
M	FXDL Low Rider	1450		2000	2003	F	



		CC	KW	FROM	TO	FRONT / REAR	LEFT / RIGHT
M	FXDL Low Rider	1450		2000	2003	R	
M	FXDLi Low Rider	1450		2004	2006	F	
M	FXDLi Low Rider	1450		2004	2006	R	
M	FXDL Low Rider	1450		2004	2005	F	
M	FXDL Low Rider	1450		2004	2005	R	
M	FXDS-Conv. / Dyna Convertible	1450		2000	2002	F	
M	FXDS-Conv. / Dyna Convertible	1450		2000	2002	R	
M	FXDWG Wide Glide	1450		2000	2003	F	
M	FXDWG Wide Glide	1450		2000	2003	R	
M	FXDWGi Wide Glide	1450		2004	2006	F	
M	FXDWGi Wide Glide	1450		2004	2006	R	
M	FXDWGi Wide Glide	1450		2004	2006	F	
M	FXDWG Wide Glide	1450		2004	2005	R	
M	FXDX Super Glide Sport	1450		2000	2003	F	
M	FXDX Super Glide Sport	1450		2000	2003	R	
M	FXDXT Super Glide T-Sport	1450		2000	2003	F	
M	FXDXT Super Glide T-Sport	1450		2000	2003	R	
M	FXDXi Super Glide Sport	1450		2004	2005	F	
M	FXDXi Super Glide Sport	1450		2004	2005	R	
M	FXST/FXSTi Softail Standard	1450		2000	2005	F	
M	FXST/FXSTi Softail Standard	1450		2000	2005	R	
M	FXSTB/FXSTBi Night Train	1450		2000	2005	F	
M	FXSTB/FXSTBi Night Train	1450		2000	2005	R	
M	FXSTD/I Softail Deuce	1450		2000	2005	F	
M	FXSTD/I Softail Deuce	1450		2000	2005	R	
M	FXSTD/I Softail Deuce	1450		2006		F	
M	FXSTS/FXSTSi Softail Springer	1450		2000	2005	R	
M	FLHRS Road King Custom	1584		2007	2007	F	
M	FLHRS Road King Custom	1584		2007	2007	R	
M	FLHT/FLHTi Electra Glide Standard	1584		2007	2007	F	
M	FLHT/FLHTi Electra Glide Standard	1584		2007	2007	R	
M	FLHTC Electra Glide Classic	1584		2007	2007	F	
M	FLHTC Electra Glide Classic	1584		2007	2007	R	
M	FLHTCU Ultra Classic Electra Glide	1584		2007	2007	F	
M	FLHTCU Ultra Classic Electra Glide	1584		2007	2007	R	
M	FLHX Street Glide	1584		2007	2007	F	
M	FLHX Street Glide	1584		2007	2007	R	
S	FLSTC Heritage Softail Classic	1584		2007	2007	F	
M	FLSTF Fat Boy	1584		2007	2007	F	
M	FXDB Street Bob (Spoke wheel)	1584		2007	2007	F	
M	FXDB Street Bob (Spoke wheel)	1584		2007	2007	R	
M	FXDC Dyna Super Glide Custom (Spoke wheels)	1584		2007	2007	F	
M	FXDC Dyna Super Glide Custom (Spoke wheels)	1584		2007	2007	R	
M	FXDL Low Rider	1584		2007	2007	F	
M	FXDL Low Rider	1584		2007	2007	R	
M	FXDWG Wide Glide	1584		2007	2007	F	
M	FXDWG Wide Glide	1584		2007	2007	R	
M	FXST/FXSTi Softail Standard	1584		2006	2007	F	
M	FXSTB/FXSTBi Night Train Softail	1584		2006	2007	F	
M	FXSTC Softail Custom	1584		2007		F	
M	FXSTD Softail Deuce	1584		2007		F	
M	FLSTFSE2 Fat Boy	1690		2006	2006	F	
M	FLSTFSE2 Fat Boy	1690		2006	2006	R	

FDB2098

115.6 x 41.0 x 8.3 mm

MATERIAL AVAILABILITY											
AG	EF	P	PRP	ST	SM	SG	ZR	XRAC	ZRAC	CP1	CPRO
	✓	✓		✓							

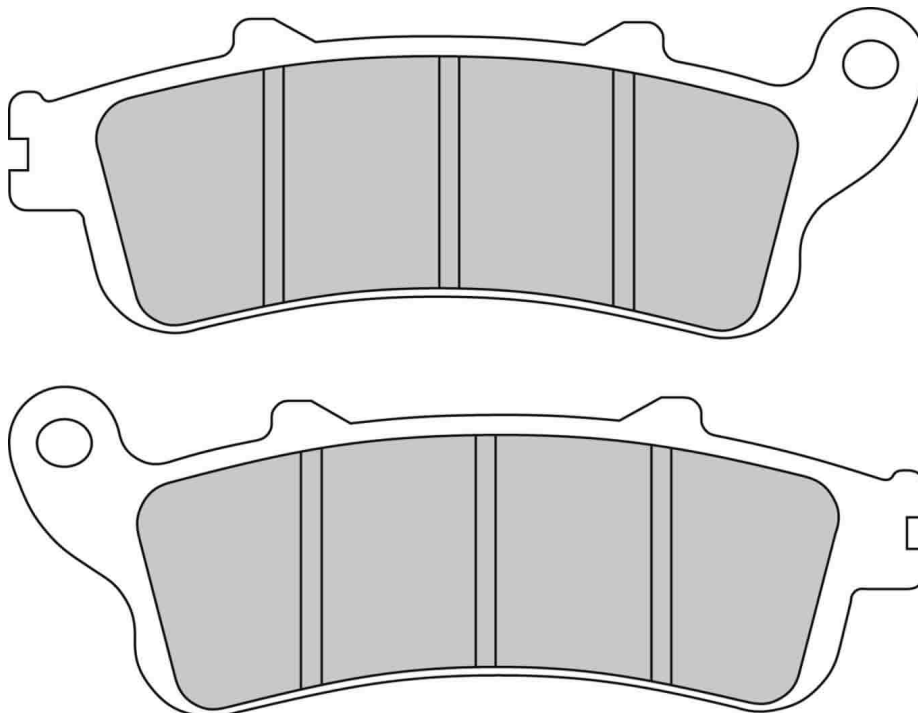

ALSO AVAILABLE		
SHAPE	TH. MM	NOTES
FDB2073	8.0	
FDB2075	9.4	

CROSS REFERENCE	
BREMBO	07HO43
CL BRAKES	2602
EBC	FA261HH
GALFER	FD207
GOLD FREN	178
LUCAS/TRW	MCB704
NEWFREN	FD0254
SBS	735
SBS	736
VESRAH	VD-165/2

		CC	KW	FROM	TO	FRONT REAR	LEFT RIGHT
	M NT 650 DEAUVILLE	650		2002		F	
	M NT 650 DEAUVILLE	650		2002		R	
	M NT 700 DEAUVILLE 680 / ABS	680		2006		R	
	M VFR 800 FI	800		1998		F	
	M VFR 800 FI	800		1998		R	
	M VFR 800 FI INTERCEPTOR / INTERCEPTOR ABS	800		2002	2005	F	
	M VFR 800 FI INTERCEPTOR / INTERCEPTOR ABS	800		2002	2005	R	
	M VFR 800	800		2006	2013	R	
	M XL 1000 V VARADERO	1000		1999	2003	F	
	M CB 1100 HORNET	1100		1999	2000	F	
	M CBR 1100 XX Superblackbird	1100		1998		F	
	M CBR 1100 XX Superblackbird	1100		1998		R	
	M ST 1100 PAN EUROPEAN ABS/TCS (Dual brake)	1100		1996	2000	F	

		CC	KW	FROM	TO	FRONT REAR	LEFT RIGHT	
	M CTX1300	1300		2014		R		
	M ST 1300 PAN EUROPEAN / ABS	1300		2002		F		
	M ST 1300 PAN EUROPEAN / ABS	1300		2002		R		
	M ST 1300 PAN EUROPEAN / ABS	1300		2008		R		
	M GL 1800 GOLDWING	1800		2001		F		
	M GL 1800 GOLDWING	1800		2001		R		
	M VTX 1800	1800		2001		F		
	M VTX 1800	1800		2001		R		
	M GOLDWING F6B	1832		2012		F		
	VICTORY	M Arlen Ness Victory Vision			2010	2012	F	
		M Vision Street			2008	2009	F	
		M Vision Tour (All models)			2008	2015	F	
		M Vision 8 Ball			2010	2011	F	

M = MOTORCYCLE
S = SCOOTER
A = ATV
Sn = SNOWMOBILE

FDB2100

31.7 x 51.1 x 6.0 mm

April 2019: AG superseded by EF

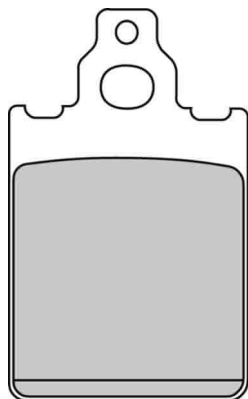

MATERIAL AVAILABILITY											
AG	EF	P	PRP	ST	SM	SG	ZR	XRAC	ZRAC	CP1	CPRO
X	✓										

ALSO AVAILABLE		
SHAPE	TH. MM	NOTES
FDB784	5.6	Different friction material area

Pinze / Calipers

GMA

Inside/Outside Pulley

CROSS REFERENCE	
CL BRAKES	2260
CL BRAKES	3005
GALFER	FD152
GOLD FREN	118
NEWFREN	FD0266
SBS	680
VESRAH	VD-949

		CC	KW	FROM	TO	FRONT / REAR	LEFT / RIGHT
PIAGGIO	M	VESPA 125 PX	125	1998	2013	F	
	M	VESPA 150 PX	150	1998		F	

		CC	KW	FROM	TO	FRONT / REAR	LEFT / RIGHT
M	VESPA 200 PX	200		1998		F	

FDB2101

59.1 x 44.6 x 9.6 mm

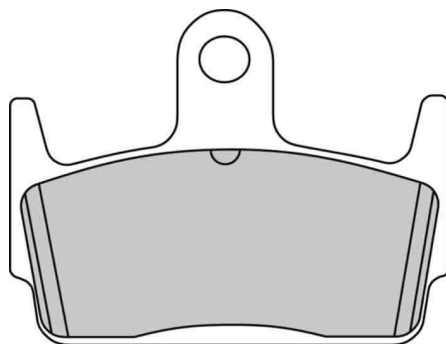

MATERIAL AVAILABILITY											
AG	EF	P	PRP	ST	SM	SG	ZR	XRAC	ZRAC	CP1	CPRO
✓											

CROSS REFERENCE	
BRAKING	774
BREMBO	07016
BREMBO	7016
CL BRAKES	3041
EBC	FA234
EBC	SFA234
GALFER	FD166
GOLD FREN	131
LUCAS/TRW	MCB686
NEWFREN	FD0224
SBS	710
VESRAH	VD-962

		CC	KW	FROM	TO	FRONT / REAR	LEFT / RIGHT
	HONDA						
	M	X8R 50 X	50	1998		R	
	M	X8R 50 S	50	1998		R	
KYMCO	M	SNIPER 50 DD	50	1994	1996	R	

		CC	KW	FROM	TO	FRONT / REAR	LEFT / RIGHT
	SYM						
	S	Jet Sport X 50 SR	50	2006	2013	R	
	S	Jet Sport X 50	50	2006	2013	R	
	S	Jet Sport X 50 S	50	2006	2013	R	

M = MOTORCYCLE
S = SCOOTER
A = ATV
Sn = SNOWMOBILE

FDB2102

74.9 x 54.5 x 9.0 mm

MATERIAL AVAILABILITY											
AG	EF	P	PRP	ST	SM	SG	ZR	XRAC	ZRAC	CP1	CPRO
		✓		✓							

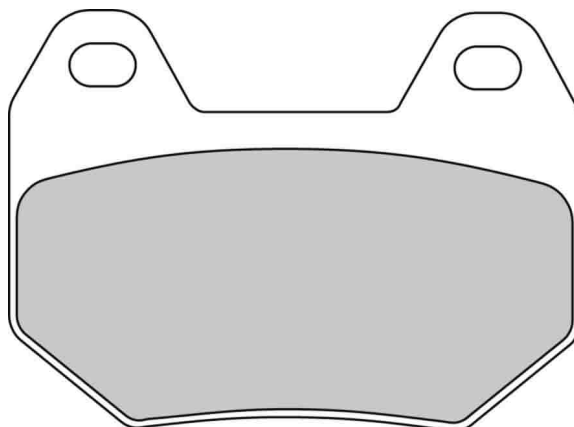

CROSS REFERENCE	
BREMBO	07BB25
CL BRAKES	2987
EBC	FA304
GALFER	FD251
LUCAS/TRW	MCB713
NEWFREN	FD0277
SBS	746
VESRAH	VD-972

			CC	KW	FROM	TO	FRONT		LEFT
							REAR	RIGHT	
BMW	M	K 1200 LT (K589)	1200	72	1999	2001	R		
	M	K 1200 LT (K589)	1200	72	2001	2003	R		

			CC	KW	FROM	TO	FRONT		LEFT
							REAR	RIGHT	
	M	K 1200 LT (K589)	1200	85	2003	2008	R		
	M	R 1200 CL	1200		2003		R		

FDB2103

56.9 x 44.3 x 6.5 mm

MATERIAL AVAILABILITY											
AG	EF	P	PRP	ST	SM	SG	ZR	XRAC	ZRAC	CP1	CPRO
		✓									

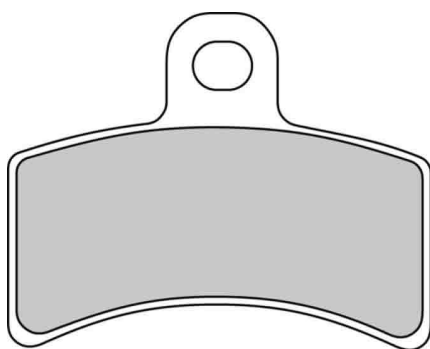

CROSS REFERENCE	
BREMBO	07GR51
BRENTA	3039
BRENTA	4039
EBC	FA291
GALFER	FD225
LUCAS/TRW	MCB770
NEWFREN	FD0268
SBS	815

		CC	KW	FROM	TO	FRONT / REAR	LEFT / RIGHT
GASGAS	M EC BOY 50	50		2001		F	
	M EC BOY 50	50		2001		R	
	M EC ROOKIE 50	50		2001		R	
	M MC 65	65		2005		F	
	M MC 65	65		2005		R	
	M TXT 80 ROOKIE	80		2002	2013	F	
	M TXT 80 ROOKIE	80		2002	2005	R	
	M TXT 80 PRO Racing	80		2015	2020	F	
	M TXT 125	125		2001	2003	F	
	M TXT 125	125		2001	2003	R	
	M TXT 200	200		2000	2003	F	

		CC	KW	FROM	TO	FRONT / REAR	LEFT / RIGHT
M	TXT 200	200		2000	2003	R	
M	TXT 249	249		2001	2003	F	
M	TXT 249	249		2001	2003	R	
M	PAMPERA 250	250		2002		R	
M	TXT 250	250		2000		F	
M	TXT 250	250		2000		R	
M	TXT 280	280		2000		F	
M	TXT 280	280		2000		R	
M	TXT 321	321		2000		F	
M	TXT 321	321		2000		R	

FDB2105

117.5 x 41.3 x 8.6 mm

MATERIAL AVAILABILITY

AG	EF	P	PRP	ST	SM	SG	ZR	XRAC	ZRAC	CP1	CPRO
✓	✓										

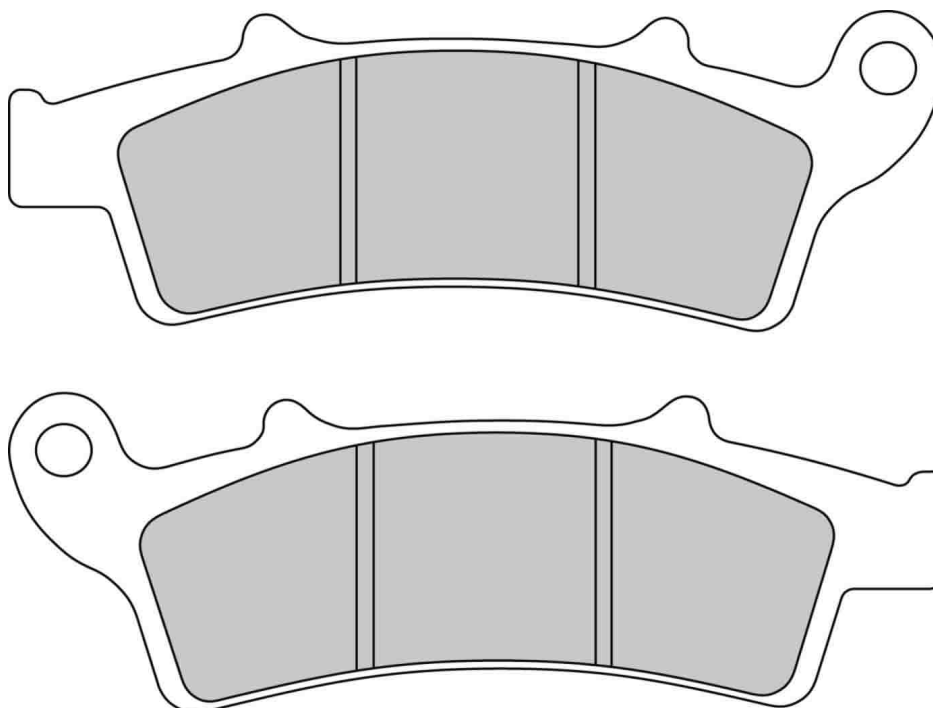

CROSS REFERENCE

BRAKING	853
BREMBO	07045
BREMBO	7045
BRENTA	3096
BRENTA	4096
CL BRAKES	3056
EBC	FA324
EBC	SFA324
GALFER	FD245
GOLD FREN	193
LUCAS/TRW	MCB726
NEWFREN	FD0282
SBS	159
SBS	761
VESRAH	VD-9017

M = MOTORCYCLE
S = SCOOTER
A = ATV
Sn = SNOWMOBILE

		CC	KW	FROM	TO	FRONT / REAR	LEFT / RIGHT
	APRILIA	S	ATLANTIC (ARECIFE) 125	125	2003	F	
	S	ATLANTIC 125	125	2010	F		
	S	SCARABEO 125 Street	125	2007	F		
	S	SCARABEO 125 GT	125	2004	F		
	S	ATLANTIC (ARECIFE) 200	200	2003	2007	F	
	S	SCARABEO 200 / Class	200	2008	F		
	S	SCARABEO 200 i.e.	200	2009	F		
	S	ATLANTIC 250	250	2008	F		
	S	SCARABEO 250	250	2004	2006	F	
	S	SCARABEO 250 ie	250	2007	F		
	S	ATLANTIC 300	300	2010	F		
	S	SCARABEO 300 Class / Special	300	2010	F		
	S	ATLANTIC Sprint 400	400	2007	F		
	S	ATLANTIC Sprint 500	500	2007	F		
	KYMCO	S	DOWNTOWN 125 i ABS	125	2015	F	
S		GRAND DINK 125 E4	125	2016	F		
S		K-XCT 125i	125	2012	F		

		CC	KW	FROM	TO	FRONT / REAR	LEFT / RIGHT	
	S	PEOPLE GT 125i	125	2010	F			
	S	People GT 125 i CBS	125	21	2019	F		
	S	Visar 125 i CBS	125	7	2019	F		
	S	X-TOWN 125i ABS	125	2016	F			
	S	X-Town CT 125	125	11	2020	F	right	
	S	PEOPLE GTi 200	200	2010	F			
	S	AGILITY maxi 300i ABS	300	2015	F			
	S	K-XCT 300i /ABS	300	2012	F			
	S	PEOPLE GTi 300	300	2010	F			
	M	PEOPLE S 300 i	300	2018	F			
	S	X-TOWN 300i ABS	300	2016	F			
	S	X-Town CT 300	300	17	2020	F	right	
	S	DOWNTOWN 350 i ABS	350	22	2015	F		
	MALAGUTI	M	MADISON 250	250	1999	2003	F	
		M	MADISON K 400	400	2002	F		
PEUGEOT	M	LOOXOR 125 / 150	125	2003	F			
PIAGGIO	M	Beverly 350 (4T 4V)(M69) No ABS	350	25	2011	F		

FDB2107

41.3 x 51.5 x 6.0 mm

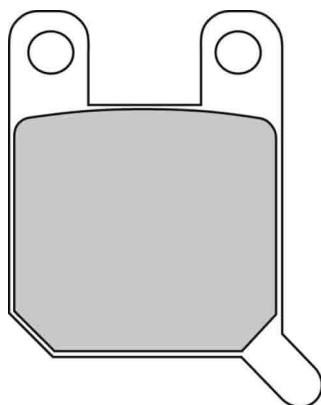

MATERIAL AVAILABILITY											
AG	EF	P	PRP	ST	SM	SG	ZR	XRAC	ZRAC	CP1	CPRO
		✓									

ALSO AVAILABLE		
SHAPE	TH. MM	NOTES
FRP405		without tab

CROSS REFERENCE	
BREMBO	07BB12
CL BRAKES	2377
NEWFREN	FD0142
SBS	559
VESRAH	VD-254
VESRAH	VD-925

		CC	KW	FROM	TO	FRONT / REAR	LEFT / RIGHT
	ALFER	M	MC 80	80	1988	R	
	M	TX 300	300	1990	F		
APRILIA	M	CLIMBER 280	280	1993	F		
	M	CLIMBER 280	280	1993	R		
BETA	M	MX 50 ENDURO	50	1992	F		
	M	MX 50 ENDURO	50	1992	R		
	M	SYNT 260	260	1992	F		
	M	ZERO 260 SYNT	260	1989	1992	F	
	M	ZERO 260 GARA - TECHNO - SYNT	260	1993	F		
BULTACO	M	LOBITO 75	75	1999	R		
CPI	M	SUPERCROSS 50	50	2003	F		
	M	SUPERCROSS 50	50	2003	R		
	M	SUPERMOTO 50	50	2003	F		
	M	SUPERMOTO 50	50	2003	R		
DERBI	M	all models 50 (disc brake)	50	1983	F		
	M	AVENTURA 50	50	1996	F		
	M	COPPA 50 FDT	50	1986	F		
	S	COPPA 50 FDX	50	1987	F		
	M	DS 50 WORLD CHAMPION	50	1988	F		

		CC	KW	FROM	TO	FRONT / REAR	LEFT / RIGHT
	M	FD 50 JUMBO	50	1985	F		
	M	FURAX 50	50	1996	F		
	M	PREDATOR 50	50	1998	F		
	M	PREDATOR 50	50	1998	R		
	M	PREDATOR 50 0.2	50	1999	F		
	M	RECORD 50	50	1998	F		
	M	SABANA 50	50	1990	F		
	M	SABANA 50	50	1990	R		
	M	SENDA 50	50	1994	R		
	M	VAMOS 50	50	1994	F		
	M	VAMOS 50 R	50	1996	F		
	M	VARIANT 50 SPORT R	50	1994	F		
	M	COPPA 75 SPORT	75	1985	F		
	M	YUMBO 75 RD-2 FDS	75	1987	F		
	FANTIC	M	K-ROO 250	250	1993	F	
M		K-ROO 250	250	1993	R		
FB MINARELLI	M	MR 80	80		F		
GASGAS	M	TXT 50 BOY	50	2004	F		
	M	TXT 50 BOY	50	2004	R		

4200

		CC	KW	FROM	TO	FRONT / REAR	LEFT / RIGHT
M	DELTA 125	125		1991		F	
M	JT 12 125	125		1995		F	
M	JT 12 125	125		1995		R	
M	PAMPERA 125	125		1996		F	
M	PAMPERA 125	125		1996		R	
M	TRIAL 125	125		1991		F	
M	TT 125	125		1995		R	
M	JTR 140 CONTACT	140		1996		F	
M	JTR 140 CONTACT	140		1996		R	
M	JT 16 150	150		1995		F	
M	JT 16 150	150		1995		R	
M	JT 160	160		1995		F	
M	JT 160	160		1995		R	
M	JT 25 250	250		1991		F	
M	JT 25 250	250		1991		R	
M	JT 250 CONTACT	250		1994		F	
M	JT 250 CONTACT	250		1994		R	
M	JTR 250 CONTACT	250		1996		F	
M	JTR 250 CONTACT	250		1996		R	
M	T 25 250 CONTACT	250		1993		F	
M	T 25 250 CONTACT	250		1993		R	
M	JTR 270 CONTACT	270		1996		F	
M	JTR 270 CONTACT	270		1996		R	
M	JT 32 320	320		1991		F	
M	JT 32 320	320		1991		R	
M	TRIAL 327	327		1989		F	
M	TRIAL 327	327		1989		R	
M	GASGAS 350	350				F	
M	GASGAS 350	350				R	
M	JT 350	350		1995		F	

		CC	KW	FROM	TO	FRONT / REAR	LEFT / RIGHT
M	JT 350	350		1995		R	
M	JTR 370 CONTACT	370		1996		F	
M	JTR 370 CONTACT	370		1996		R	
MONTESA	M COTA 309	309		1989		F	
M	COTA 335	335		1989		F	
M	COTA 335	335		1989		R	
M	H7-S 360	360				F	
MONTESA (HONDA)	M COTA 310	310		1989		F	
PUCH	M CONDOR 50	50				F	
M	MONZA 50	50		1985		F	
M	COBRA 75	75		1985		F	
M	COBRA 80	80		1984		F	
RIEJU	M MR 80	80				F	
SHERCO	M Enduro 50cc (2T)	50		2002	2007	R	
M	Supermotard 50cc (2T)	50		2002	2007	R	
M	Trials 0.8 (2T)	80		2001	2004	F	
M	City Corp 125 (All models)	125		2003	2007	R	
M	Trials 1.25cc (2T)	125		1999	2005	F	
M	Trials 1.25cc (2T)	125		1999	2005	R	
M	Trials 2.0cc (2T)	200		1999	2005	F	
M	Trials 2.0cc (2T)	200		1999	2005	R	
M	Trials 2.5 (2T)	250		1999	2005	F	
M	Trials 2.5 (2T)	250		1999	2005	R	
M	Trials 2.9 (2T)	290		1999	2005	F	
M	Trials 2.9 (2T)	290		1999	2005	R	
YAMAHA	M DT 50 R	50		2008		F	
M	DT 50 R	50		2008		R	
M	TY 250 Z	250		1993	1995	F	
M	TY 250 Z	250		1993	1995	R	

FDB2108

70.2 x 41.8 x 8.1 mm

July 2016: AG superseded by EF

MATERIAL AVAILABILITY

AG	EF	P	PRP	ST	SM	SG	ZR	XRAC	ZRAC	CP1	CPRO
✗	✓										

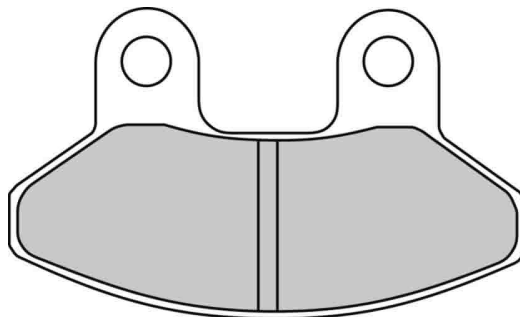



CROSS REFERENCE

BRAKING	963
BREMBO	07062
BREMBO	7062
BRENTA	3149
BRENTA	4149
EBC	FA306
EBC	SFA306
GALFER	FD412
GOLD FREN	234
LUCAS/TRW	MCB779
NEWFREN	FD0293
SBS	178
SBS	792
VESRAH	VD-994

M = MOTORCYCLE
S = SCOOTER
A = ATV
Sn = SNOWMOBILE

FERODO
RACING
Updated on November 2020

4201

		CC	KW	FROM	TO	FRONT / REAR	LEFT / RIGHT
	LAVERDA	M	PHOENIX 125 / 150 / 200	125		2001	F
	SYM	M	RS 50	50		2004	F
		M	SHARK 50	50		1999 2003	F
		S	Mio 115 CBS	115		2017 2018	F
		M	JOYRIDE 125	125		2001 2005	F
		M	JOYRIDE 125 EURO2	125		2005 2006	F
		S	JOYRIDE (Euro2 - Euro3)	125		2005 2006	F
		S	Joyride 125 i	125		2007 2009	F
		S	Joyride EVO 125 i (Twin Headlights)	125		2009	F
		S	Joyride S 125i	125		2016	F
		M	EURO MX 125	125		2002	F
		S	Euro MX 125 (HF12W3-6 Euro 2) (Rear disc model)	125		2006 2009	F
		M	RS 125	125		2001	F
		M	SHARK 125	125		1999 2002	F

		CC	KW	FROM	TO	FRONT / REAR	LEFT / RIGHT
	M	SHARK 4 VR 125	125		2000 2002	F	
	M	VS 125	125		2006	F	
	M	JOYRIDE 150	150		2001	F	
	M	EURO MX 150	150		2002	F	
	M	RS 150	150		2001	F	
	S	RS 150	150		2006	F	
	M	SHARK 150	150		1999 2002	F	
	M	SHARK 4 VR 150	150		2000 2002	F	
	M	VS 150	150		2006	F	
	M	JOYRIDE 200	200		2001	F	
	S	Joyride 200 i	200		2007 2009	F	
	S	Joyride EVO 200 i	200		2009	F	
	S	Joyride S. 200i	200		2016	F	

FDB2109

50.1 x 43.5 x 6.0 mm

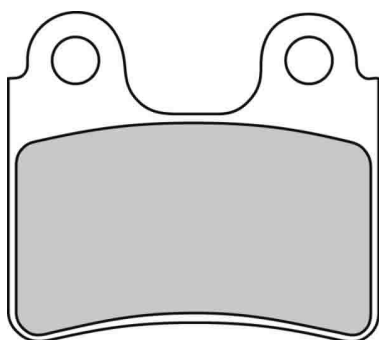



MATERIAL AVAILABILITY

AG	EF	P	PRP	ST	SM	SG	ZR	XRAC	ZRAC	CP1	CPRO
		✓				✗					

CROSS REFERENCE

BRAKING	831
BREMBO	07GR58
BRENTA	3040
BRENTA	4040
EBC	FA303
GALFER	FD223
LUCAS/TRW	MCB766
NEWFREN	FD0292
SBS	802
VESRAH	VD-9001

		CC	KW	FROM	TO	FRONT / REAR	LEFT / RIGHT
	AJP	M	PR3 125 Enduro	125		2008 2012	R
		M	PR3 125 Enduro Pro	125		2008 2012	R
		M	PR3 125 Supermoto	125		2008 2012	R
		M	PR3 125 Supermoto Pro	125		2010 2011	R
		M	PR3 125 Trial	125		2011 2012	R
		M	PR4 Enduro 125	125		2004 2009	R
		M	PR4 Supermoto 125	125		2004 2009	R
		M	PR3 200 Enduro	200		2008 2011	R
		M	PR3 200 Enduro Pro	200		2010 2011	R
		M	PR3 200 M/X	200		2010 2011	R
		M	PR3 200 M/X Pro	200		2010 2011	R
		M	PR3 200 Supermotard Pro	200		2010 2011	R
		M	PR3 200 Supermoto	200		2008 2011	R
		M	PR4 Enduro 200	200		2004 2009	R
		M	PR4 200 Supermoto	200		2004 2009	R
BETA		M	EVO 80	80		2009 2012	F
		M	REV 80	80		2008 2011	F
		M	EVO 125 2T	125		2009	F
		M	Rev 3 125	125		2000 2005	F
		M	Rev 3 125	125		2000 2005	R

		CC	KW	FROM	TO	FRONT / REAR	LEFT / RIGHT
	M	Rev 3 125	125		2006 2008	F	
	M	EVO 200 2T	200		2009 2012	F	
	M	Rev 3 200	200		2006 2008	F	
	M	Evo 250 (2T)	250		2009 2012	F	
	M	Evo 250 (4T)	250		2009 2012	F	
	M	REV 3 250	250		2000 2004	F	
	M	REV 3 250	250		2000 2004	R	
	M	REV 3 250	250		2005 2008	F	
	M	REV 3 250 4T	250		2007 2008	F	
	M	REV 3 250 2T	250		2008	F	
	M	Rev 3 270	270		2000 2004	F	
	M	Rev 3 270	270		2000 2004	R	
	M	Rev 3 270	270		2005 2008	F	
	M	EVO 290 2T	290		2009	F	
	M	EVO 300 2T/4T	300		2009 2012	F	
GASGAS	M	TXT 125 / 200 / 250 / 280 / 300	125		2004	F	
MONTESSA (HONDA)	M	COTA 250 4RT	250		2005 2010	F	
	M	COTA 260 4RT	260		2014	F	
	M	COTA 310 4T / 4RT	310		2007	F	
	M	MH 315 R	315		2001 2004	F	

4202

FERODO

RACING

Updated on November 2020

M = MOTORCYCLE
S = SCOOTER
A = ATV
Sn = SNOWMOBILE

		CC	KW	FROM	TO	FRONT / REAR	LEFT / RIGHT
	SCORPA	M	SR 125 (2T)	125	2010	2013	F
	M	SR 125 Long Ride (2T)	125	2010	2011	F	
	M	SY 125 (4T) Long Ride	125	2009	2010	F	
	M	TY 125 (4T)	125	2011	2013	F	
	M	SY 200 F (4T) (163cc)	200	2008	2008	F	
	M	SY 250 F (4T) Long Ride	250	2007	2008	F	
	M	SY 250 FR (4T) Long Ride	250	2010	2010	F	
	M	SR 280 (2T)	280	2009		F	
M	SR 280 (2T) Long Ride	280	2009	2011	F		

		CC	KW	FROM	TO	FRONT / REAR	LEFT / RIGHT
	SHERCO	M	Trials 0.8 (2T) AJP CALIPER	80	2005	2010	F
	M	ST125 (2T) AJP CALIPER	125	2015		F	
	M	Trials 1.25cc (2T) AJP CALIPER	125	2006	2011	F	
	M	XY	125	2014		F	
	M	ST250 (2T) AJP CALIPER	250	2015		F	
	M	Trials 2.5 (2T) AJP CALIPER	250	2006	2011	F	
	M	Trials 2.9 (2T) AJP CALIPER	290	2006	2011	F	
	M	ST300 (2T) AJP CALIPER	300	2015		F	
M	Trials 3.2cc (4T) AJP CALIPER	320	2005	2011	F		

FDB2110

67.7 x 36.5 x 7.5 mm / 51.9 x 40.0 x 7.5 mm

MATERIAL AVAILABILITY

AG	EF	P	PRP	ST	SM	SG	ZR	XRAC	ZRAC	CP1	CPO
						✓					

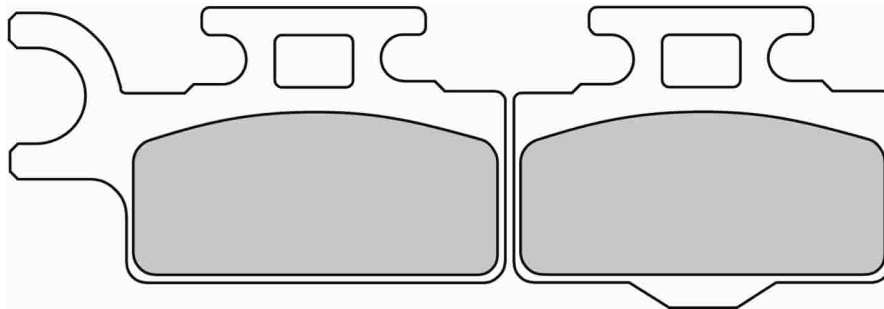

CROSS REFERENCE

BRAKING	894
BREMBO	07KA27
CL BRAKES	1034
EBC	FA302
GALFER	FD254
LUCAS/TRW	MCB714
NEWFREN	FD0295
SBS	752
VESRAH	VD-440

		CC	KW	FROM	TO	FRONT / REAR	LEFT / RIGHT
	KAWASAKI	M	KX 65	65	1999		F
	M	KX 65	65	2000		F	

		CC	KW	FROM	TO	FRONT / REAR	LEFT / RIGHT
	SUZUKI	M	RM 65	65	2003		F

FDB2111

59.9 x 57.2 x 8.1 mm

SG compound superseded by ST

MATERIAL AVAILABILITY											
AG	EF	P	PRP	ST	SM	SG	ZR	XRAC	ZRAC	CP1	CPR0
	✓	✓		✓		✗					

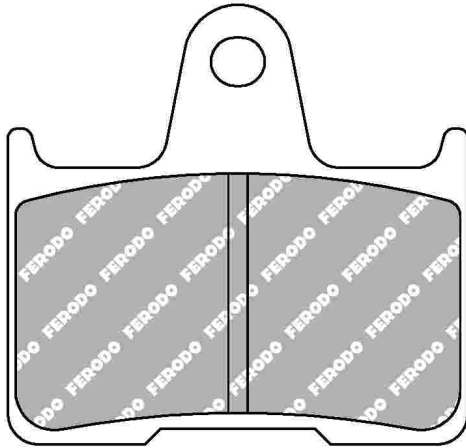

CROSS REFERENCE	
BRAKING	875
BREMBO	07KA21
BREMBO	07SU25
BRENTA	3137
BRENTA	4137
CL BRAKES	2813
EBC	FA254
GALFER	FD267
GOLD FREN	148
LUCAS/TRW	MCB691
LUCAS/TRW	MCB729
NEWFREN	FD0272
SBS	715
SBS	765
VESRAH	VD-436

		CC	KW	FROM	TO	FRONT / REAR	LEFT / RIGHT	
	M XL 883 L Super Low (Cast Wheels)	883		2014		R		
	M XL 883 N Iron (Cast Wheel)	883		2014	2017	R		
	M XL 883 R Roadster (Cast Wheel)	883		2014		R		
	M XL 1200 C Custom (Spoke Wheels)	1200		2014	2017	R		
	M XL 1200 V - Seventy Two	1200		2014		R		
	M XL 1200 T Superlow	1200		2014		R		
	M XL 1200 X - Forty Eight	1200	50	2014	2017	R		
	M XL 1200 CA Custom Limited A	1200		2015		R		
	M XL 1200 CB Custom Limited B	1200		2015		R		
	M XL 1200 NS Iron	1202		2019		R		
	M XL 1200 XS Forty Eight Special	1202		2019		R		
	M XL 1200 CX Roadster	1202		2016	2017	R		
	HONDA	M CB 400 SUPER FOUR (SF)	400		1999	2003	R	
		M VT 750 C2 SHADOW	750		2010	2012	R	
	M CB 1300 SF	1300		1998	2000	R		
	M CB 1300 X4	1300		1997	2000	R		
KAWASAKI	M ZX-7 750 RR NINJA N1	750		1996	1999	R		
	M 1400 GTR	1400		2007		R		
	M 1400 GTR	1400		2015		R		
	M ZZR 1400	1400		2006		R		
	M ZZR 1400	1400		2016		R		
	M ZZR 1400 Performance Sport	1400		2016		R		
SUZUKI	M GSX-R 600	600		2004	2005	R		
	M GSX-R 600 - Racing Applications	600		2004	2005	R		

		CC	KW	FROM	TO	FRONT / REAR	LEFT / RIGHT	
	M GSF 650 (Naked Bandid -Non ABS)	650		2005	2006	R		
	M GSF 650 S (Faired Bandid -Non ABS)	650		2005	2006	R		
	M GSX-R 750 - Racing Applications	750		2004	2005	R		
	M GSX-R 1000	1000		2001	2002	R		
	M GSX-R 1000	1000		2003	2003	R		
	M GSX-R 1000	1000		2004	2006	R		
	M GSX-R 1000 (Racing Applications)	1000		2001	2002	R		
	M GSX-R 1000 - Racing Applications	1000		2004	2008	R		
	M GSX 1400	1400		2002		R		
	YAMAHA SNOWMOBILE	Sn NISSIN (all models)			1997	1999	R	
		Sn SX 500R	500				R	
		Sn V-MAX 500 (all)	500		1997	1999	R	
		Sn VENTURE 500	500		1997	2000	R	
		Sn SRX 600	600		1998	1999	R	
		Sn SX 600R	600				R	
		Sn V-MAX 600 (all)	600		1997	1999	R	
		Sn VENTURE 600	600		1997	2000	R	
		Sn SRX 700	700		1998	1999	R	
	Sn SRX 700 - MOUNTAIN MAX 700	700		2000	2001	R		
	Sn SX 700R	700				R		
	Sn V-MAX 700 (all)	700		1997	1999	R		
	Sn VENTURE 700	700		1997	2000	R		
	Sn V-MAX 800	800		1998	2000	R		

FDB2113

81.2 x 42.0 x 9.5 mm

MATERIAL AVAILABILITY

AG	EF	P	PRP	ST	SM	SG	ZR	XRAC	ZRAC	CP1	CPRO
		✓									

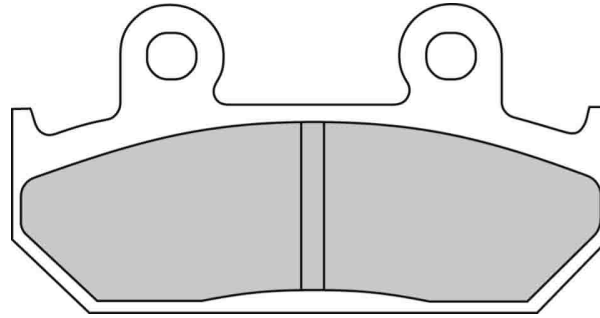

ALSO AVAILABLE

SHAPE	TH. MM	NOTES
FDB462	8.0	

CROSS REFERENCE

BREMBO	07HO21
CL BRAKES	2252
EBC	FA203
NEWFREN	FD0106
SBS	593



HONDA

M CBR 600 F2

CC

KW

FROM

TO

FRONT
/ REAR

LEFT
/ RIGHT

600

1991

1994

F

M = MOTORCYCLE
S = SCOOTER
A = ATV
Sn = SNOWMOBILE

FDB2114

74.0 x 55.1 x 7.1 mm

MATERIAL AVAILABILITY											
AG	EF	P	PRP	ST	SM	SG	ZR	XRAC	ZRAC	CP1	CPRO
		✓		✓				✓			

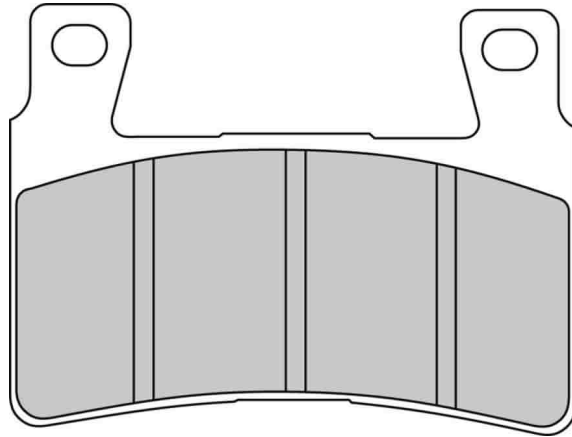



ALSO AVAILABLE		
SHAPE	TH. MM	NOTES
FDB2079	9.0	

CROSS REFERENCE	
BREMBO	07HO45
BREMBO	07KA29
BRENTA	4170
CL BRAKES	2711
EBC	FA296HH
GALFER	FD219
GOLD FREN	134
LUCAS/TRW	MCB703
NEWFREN	FD0258
SBS	734
VESRAH	VD-166

		CC	KW	FROM	TO	FRONT / REAR	LEFT / RIGHT
	HARLEY DAVIDSON						
M	XR 1200	1200		2008	2010	F	
M	XR 1200 X	1200		2010	2012	F	
S	FLSTC Heritage Softail Classic	1584		2015	2015	F	
M	FLSTF Fat Boy	1584		2015		F	
M	FLSTFB Fat Boy Special/Lo	1584		2015		F	
M	FLSTN Softail Deluxe	1584		2015		F	
M	FXST Softail Standard	1584		2015		F	
M	FLS Softail Slim	1690		2015		F	
M	FLSTC Heritage Softail Classic	1690		2015		F	
M	FLSTFB Fat Boy Special/Lo	1690		2015		F	
M	FLSTF Fat Boy	1690		2015		F	
M	FLSTN Softail Deluxe	1690		2015		F	
M	FXSB Breakout	1690		2015		F	
M	FLDE Deluxe	1745		2018		F	
M	FLFB Fat Boy	1745		2018		F	
M	FLHC Heritage Classic	1745		2018		F	
M	FLS Softail Slim	1745		2018		F	
M	FLSL Softail Slim	1745		2018		F	
M	FLSL Softail Deluxe	1745		2018		F	
M	FLSTC Heritage Softail Classic	1745		2018		F	
M	FLSTF Fat Boy	1745		2018		F	
M	FXBB Street Bob	1745		2018		F	
M	FXBR Breakout	1745		2018		F	
M	FXBS Fat Bob	1745		2018		F	
M	FXFB Fat Bob	1745		2018		F	
M	FXLR Low Rider	1745		2018		F	
M	FXSB Breakout	1745		2018		F	

		CC	KW	FROM	TO	FRONT / REAR	LEFT / RIGHT
	HONDA						
M	FLSB Sport Glide	1745		2018		F	
M	FLS Softail Slim S	1802		2016		F	
M	FLSTC Heritage Softail Classic	1802		2016		F	
M	FLSTF Fat Boy S	1802		2016		F	
M	FLFBS Fat Boy 114	1868		2018		F	
M	FLHCS Heritage Classic 114	1868		2018		F	
M	FLSTC Heritage Softail Classic 114	1868		2018		F	
M	FXBRS Breakout 114	1868		2018		F	
M	FXDR 114	1868		2020		F	
M	FXDRS 114	1868		2019		F	
M	FXFBS Fat Bob	1868		2018		F	
M	FXSB Breakout 114	1868		2018		F	
M	CB 600 F HORNET (Japan)	600		1998		F	
M	CBR 600 F (Japan)	600		1999	2004	F	
M	CBR 900 RR-FIREBLADE (Japan)	900		1998	2003	F	
M	VTR 1000 SP-1 (Japan)	1000		2000	2004	F	
M	GOLDWING F6C	1832		2014		F	
HYOSUNG							
M	GD 250 N	250		2013		F	
M	GD 250 R	250		2015		F	
M	GT 300 R	300		2016		F	
M	GV 300	300		2016		F	
M	GD 450	450		2016		F	
M	GT 650 (Naked)	650		2009	2011	F	
M	GT 650 i R	650		2009	2013	F	
M	GT 650 i (Naked)	650		2012		F	
M	GT 650 i R	650		2014		F	
M	GT 650 P	650		2016		F	

		CC	KW	FROM	TO	FRONT / REAR	LEFT / RIGHT
	M ST7	678		2010		F	
	M ST7-Deluxe	678		2012		F	

		CC	KW	FROM	TO	FRONT / REAR	LEFT / RIGHT
	M GV 700 AQUILA	700		2010		F	

FDB2115

55.6 x 49.1 x 7.2 mm

July 2016: AG superseded by EF

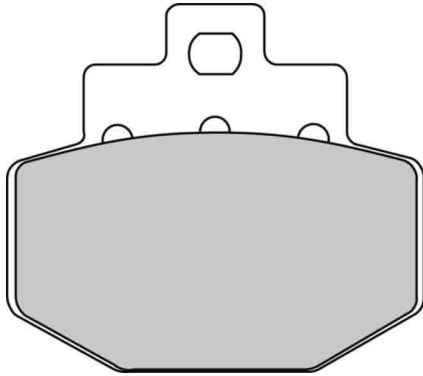

MATERIAL AVAILABILITY											
AG	EF	P	PRP	ST	SM	SG	ZR	XRAC	ZRAC	CP1	CPR0
✗	✓	✓									

CROSS REFERENCE	
BRAKING	871
BREMBO	07047
BREMBO	7047
BRENTA	3024
BRENTA	4024
CL BRAKES	3054
EBC	FA321
EBC	SFA321
GALFER	FD263
GOLD FREN	186
LUCAS/TRW	MCB727
NEWFREN	FD0298
SBS	166
SBS	772
VESRAH	VD-981

		CC	KW	FROM	TO	FRONT / REAR	LEFT / RIGHT
	BENELLI						
	M ADIVA 125	125		1999		R	
	M ADIVA 150	150		1999		R	
	GILERA						
	M DNA 125	125		2000	2003	R	
	M RUNNER 125 VX 4T	125		2001		R	
	M DNA 180	180		2001	2002	R	
	M RUNNER 180 VXR 4T	180		2001		R	
	M RUNNER 200 VXR	200		2004		R	
	PIAGGIO						
	S Vespa Electric		3	2020		F	
	M SUPER HEXAGON 125 GTX	125		2001		R	
	M VESPA GRANTURISMO 125 (Grimeca caliper)	125		2003		R	
	M VESPA GRANTURISMO 125 (Heng Tong caliper)	125		2003		R	
	S Vespa GTS 125	125		2007	2011	R	
	S Vespa GTV 125	125		2007	2009	R	
	S Vespa GTS 125 Super 4T i.e.	125		2010	2013	R	
	S VESPA 946 Special - 125 (4T/3V)	125		2013		R	
	S Vespa GTS 125 i.e. Supersport	125		2013	2013	R	
	S Vespa GTS 125 Super 4T i.e. ABS	125		2015		R	

		CC	KW	FROM	TO	FRONT / REAR	LEFT / RIGHT
	S						
	VESPA 125 GTS i.e. ABS E4	125		2016	2017	R	
	S Vespa GTS 125 Liquid cooled	125		2017		R	
	M SUPER HEXAGON 150 GTX	150		2001		R	
	S VESPA 150 GTS i.e. ABS E4	150		2016	2017	R	
	M SUPER HEXAGON 180 GTX	180		2001	2003	R	
	M VESPA GRANTURISMO 200 (Grimeca caliper)	200		2003		R	
	M VESPA GRANTURISMO 200 (Heng Tong caliper)	200		2003		R	
	M SUPER HEXAGON 250 GTX	250		2001	2002	R	
	M VESPA GTS - GTV 250 ie	250		2008		R	
	M GTV Via Montenapoleone 280	280		2010		R	
	M VESPA GTS 300 Super	300		2008		R	
	M VESPA GTS 300 i.e. Supersport	300		2010	2013	R	
	M VESPA GTS 300 i.e. Touring	300		2011	2012	R	
	M VESPA GTS 300 i.e.	300		2012		R	
	S VESPA 300 GTS i.e. ABS E4	300		2016	2017	R	
	S Vespa Sei giorni HPE ABS II ed.	300		2020		R	

M = MOTORCYCLE
S = SCOOTER
A = ATV
Sn = SNOWMOBILE

FDB2119

81.3 x 42.1 x 9.4 mm

MATERIAL AVAILABILITY											
AG	EF	P	PRP	ST	SM	SG	ZR	XRAC	ZRAC	CP1	CPRO
✓	✓	✓			✓	✓					

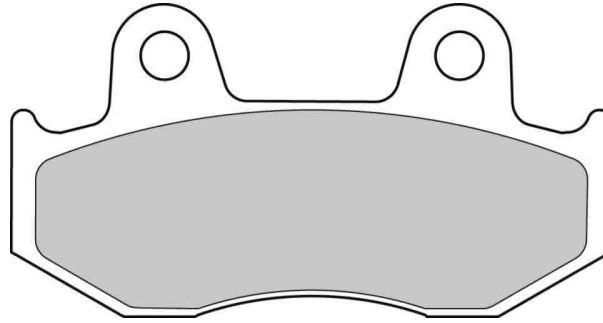

ALSO AVAILABLE		
SHAPE	TH. MM	NOTES
FDB382	7.5	
FDB2086	8.0	
FDB2132	8.3	pin on the backplate

CROSS REFERENCE	
BREMBO	07038
BREMBO	7038
BRENTA	3034
BRENTA	4034
CL BRAKES	3019
CL BRAKES	3073
EBC	FA323
GALFER	FD284
GOLD FREN	188
LUCAS/TRW	MCB685
NEWFREN	FD0304
SBS	125
SBS	781
VESRAH	VD-134/2

		CC	KW	FROM	TO	FRONT REAR	LEFT RIGHT
HONDA	M NH 100 LEAD	100		2000		F	
	S CHA 125 SPACY	125		1995	2003	F	
	M 125 DYLAN	125		2002		F	
	M @ 125 NES	125		2000		F	
	S PES 125 INJECTION	125		2008	2010	F	
	S PES 125 INJECTION SPORTY	125		2008	2009	F	
	S PS 125 i	125		2007		F	
	M SH 125 (JF09)	125	10	2001	2004	F	
	M SH 125i (JF14)	125	10	2005	2007	F	
	S SH 125 S	125		2007		F	
	S SH 125 R	125		2008		F	
	S SH 125 D	125		2009		F	

		CC	KW	FROM	TO	FRONT REAR	LEFT RIGHT
	S SPACY 125	125		2007		F	
	M @ 150 NES	150		2000		F	
	S PES 150 INJECTION	150		2008	2010	F	
	S PES 150 R TWO TONES	150		2008	2009	F	
	S PES 150 R INJECTION	150		2010		F	
	S PS 150i	150		2008		F	
	M SH 150 (KF04)	150	12	2001	2004	F	
	M SH 150 (KF08)	150	12	2005	2008	F	
	S SH 150 R	150		2008		F	
	S SH 150 S	150		2008		F	
	YAMAHA ATV A YFZ 450 - All models	450		2006		R	

FDB2120

35.2 x 39.7 x 7.6 mm

Set=4 Pads



MATERIAL AVAILABILITY											
AG	EF	P	PRP	ST	SM	SG	ZR	XRAC	ZRAC	CP1	CPRO
				✓				✓	✓		

ALSO AVAILABLE		
SHAPE	TH. MM	NOTES
FDB2215	8.5	Racing Applications
FDB2255	9	Only for BMW

Pinze / Calipers

BREMBO

P4 34 Axial caliper Four Pads XA32950

CROSS REFERENCE	
BRAKING	870
BREMBO	07BB05
BRENTA	3107
BRENTA	4107
CL BRAKES	1033
DP (Dunlop) BRAKE	DP638
EBC	FA322/4HH
GALFER	FD262
GOLD FREN	177
LUCAS/TRW	MCB721
NEWFREN	FD0305
SBS	762
VESRAH	VD-986

		CC	KW	FROM	TO	FRONT / REAR	LEFT / RIGHT
	M RSV 1000 MILLE	1000		2001		F	
	M RSV 1000 MILLE TUONO RACING	1000		2004		F	
	M RSV 1000 MILLE R	1000		2001	2003	F	
	M RSV 1000 MILLE R FACTORY	1000		2004		F	
BENELLI	M BX 449 Motard	449		2010		F	
	M BX 570 Motard	570		2008	2010	F	
	M TNT Cafe Racer 899	899		2010	2012	F	
	M TNT Century Racer 899	899		2011	2012	F	
	M TORNADO TRE 900	900		2002		F	
	M TORNADO TRE 900 RS	900		2003		F	
	M TNT 1130 Sport/Sport Evo	1130		2004	2009	F	
	M TNT 1130	1130		2006	2010	F	
	M TNT 1130 Titanium	1130		2006	2006	F	
	M TNT 1130 Cafe Racer	1130		2006	2012	F	
	M TORNADO TRE 1130	1130		2006		F	
	M TNT R 160	1130		2009	2012	F	
	M TNT 1130 Century Racer	1130		2011		F	
M TNT 1130 R	1130		2011	2013	F		
BIMOTA	M DB6 Delirio (992cc) Ducati engine	992		2007		F	
	M DB5 (All models)	1000		2006	2007	F	
	M DB5R	1078		2006	2007	F	
	M DB5R/S (1078cc)	1078		2008	2009	F	
	M DB6 Delirio	1078		2006		F	
	M DB6 (1078cc)	1078		2008	2009	F	
	M DB6/R (1078cc)	1078		2008	2009	F	
	M Tesi 3D Naked	1078		2007		F	
	M Tesi 3D (1078cc)	1078		2009		F	
	M DB7 (1098cc)	1098		2008		F	
M DB6 (1100cc)	1100		2008		F		
M DB6R Delirio (1100cc)	1100		2008		F		
M DB9 Brivido	1198		2012		F		
CAGIVA	M RAPTOR X3 1000	1000		2003		F	
DERBI	M MULHACEN CAFE' 659 Angel Nieto Lim. Ed.	659		2008		F	
DUCATI	M 748 / 748R / 748S	748		2001		F	
	M 749 / 749R / 749S / 749 DARK	749		2003		F	
	M 996 R TESTA STRETTA	996		2001		F	
	M 998 R	998		2002		F	
	M 998 SFE	998		2003		F	
M 999 R / S	999		2003		F		

		CC	KW	FROM	TO	FRONT / REAR	LEFT / RIGHT	
	M MONSTER S4R /S4RS 1000	1000		2006	2007	F		
	M MONSTER S4R S Testastretta/tricolore	1000		2008		F		
	HUSQVARNA	M SMR 449 (4T)	449		2011		F	
	M SM 450 RR (Radial Caliper)	450		2006	2007	F		
	M SM 450 R Radial caliper	450		2007	2010	F		
	M SM 450 RR	450		2008	2010	F		
	M SM 510 R (Radial caliper)	510		2006	2010	F		
	M SMR 511	511		2011	2013	F		
	M SM 530 RR	530		2008	2010	F		
	M SM 610 S (Radial caliper)	610		2006	2006	F		
	M SM 610 IE	610		2007	2009	F		
	M SMR 630 (4T)	630		2010	2012	F		
	M STR 650 CRC	630		2007		F		
	M STR 650	650		2007		F		
M 701 SUPERMOTO	690		2015		F			
KTM	M 690 DUKE R	690		2010	2012	F		
	M LC4 690 SUPERMOTO Prestige	690		2007		F		
	M 690 SMC R (ABS Std)	690	55	2013		F		
	M 690 SMR / SMC / DUKE / SupermotoR	690		2008		F		
	M DUKE 950 / 990 / 990 RC8	950		2003		F		
	M SUPERMOTO 950	950		2005		F		
	M 990 SMR	990		2008	2009	F		
	M 990 SMT	990		2009		F		
	M 990 SUPERDUKE	990		2005	2011	F		
	M 990 SUPERDUKE R	990		2007		F		
LAVERDA	M SFC 1000	1000		2003		F		
MOTO GUZZI	M MGS - 01 Corsa	1225		2007		F		
MV AGUSTA	M BRUTALE 910 R	910		2006	2008	F		
	M F4 1000 R	998		2006	2007	F		
	M F4 1000 312R (Up to VIN #008064)	998		2007	2007	F		
	M F4 1000 312R 1+1	998		2007	2008	F		
SHERCO	M SM 4.5i F (Black Panther)	450		2008	2012	F		
	M SM 5.1i F Black Panther	510		2008	2012	F		
SWM	M SM 500 R	500		2015		F		
	M Super Dual	650		2015		F		
TM	M SMM 125 (2T) Black Dream (320mm front disc)	125		2008	2012	F		
	M SMR 125 (2T)	125		2015		F		
	M SMX 125 (2T)	125		2015		F		
	M SMM 250 Fi (4T)	250		2010		F		

M = MOTORCYCLE
S = SCOOTER
A = ATV
Sn = SNOWMOBILE

		CC	KW	FROM	TO	FRONT / REAR	LEFT / RIGHT
M	SMM 250 (2T)	250		2015		F	
M	SMR 250 Fi (4T)	250		2010		F	
M	SMR 250 (2T)	250		2015		F	
M	SMX 250 Fi (4T)	250		2012		F	
M	SMX 250 (2T)	250		2015		F	
M	SMM 300 (2T)	300		2015		F	
M	SMR 300 (2T)	300		2015		F	
M	SMX 300 (2T)	300		2015		F	
M	SMM 450 F Black Dream ES (320mm front disc)	450		2008	2010	F	
M	SMM 450 Fi (4T)	450		2011		F	
M	SMR 450 Fi (4T)	450		2010		F	

		CC	KW	FROM	TO	FRONT / REAR	LEFT / RIGHT
M	SMX 450 F Competition (4T)	450		2005	2008	F	
M	SMX 450 Fi (4T)	450		2005		F	
M	SMM 530 F Black Dream ES (320mm front disc)	530		2008	2010	F	
M	SMM 530 Fi (4T)	530		2016		F	
M	SMR 530 Fi (4T)	530		2010		F	
M	SMR 530 Fi ES	530		2015		F	
M	SMX 530 Fi (T)	530		2005		F	
M	SMX 660 F	660		2005	2010	F	
TRIUMPH	M SPEED TRIPLE 1050	1050		2007	2012	F	
M	Speed twin	1200	71	2020		F	

FDB2121

74.2 x 53.2 x 7.0 mm

MATERIAL AVAILABILITY											
AG	EF	P	PRP	ST	SM	SG	ZR	XRAC	ZRAC	CP1	CPRO
						✓					

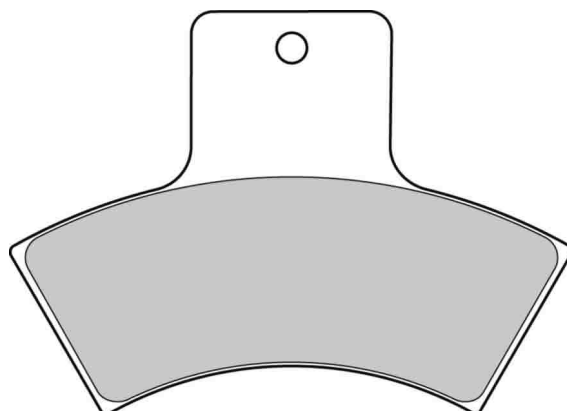

CROSS REFERENCE	
BRAKING	860
BREMBO	07PO04
CL BRAKES	2925
EBC	FA270
GALFER	FD301
LUCAS/TRW	MCB762
NEWFREN	FD0294
SBS	755
VESRAH	VD-963

		CC	KW	FROM	TO	FRONT / REAR	LEFT / RIGHT
POLARIS ATV	A MAGNUM (All models)			1999	2001	R	
	A SCRAMBLER (All Models)			1998	2004	R	
	A TRAIL BOSS (All Models)			2000	2004	R	
	A TRAIL BLAZER 250	250		1999	2004	R	
	A XPLOER 250	250		2000		R	
	A XPEDITION 325	325		2000	2001	R	
	A SPORTSMAN 335	335		1999	2000	R	
	A Sport 400	400		1999	2000	R	
	A SPORTSMAN 400	400		2001	2002	R	

		CC	KW	FROM	TO	FRONT / REAR	LEFT / RIGHT
	A XPLOER 400	400		1999	2002	R	
	A XPEDITION 425	425		2000		R	
	A DIESEL 455	455		1999	2001	R	
	A SPORTSMAN 500	500		1998	2002	R	
QUADZILLA	A CUV 300 E 4x4 Side x Side	300		2008	2009	R	
	A CVT 320 e Parking brake	320		2007	2011	R	
	A 320 e 4x4 Parking brake	320		2007	2008	F	
	A QZ 320 E 4x4	320		2009	2009	R	

FDB2122

49.8 x 36.0 x 8.1 mm

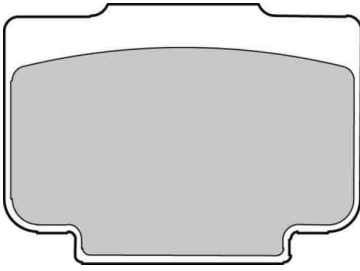

MATERIAL AVAILABILITY											
AG	EF	P	PRP	ST	SM	SG	ZR	XRAC	ZRAC	CP1	CPRO
		✓									

Pinze / Calipers

BREMBO

Brembo Racing, Billet rear

CROSS REFERENCE

BREMBO	07.9340.10
NEWFREN	FD0340

FDB2123

77.8 x 40.8 x 10.0 mm

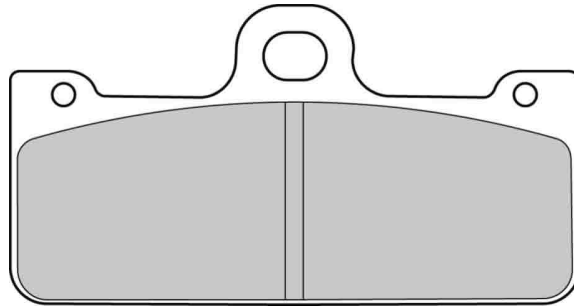

MATERIAL AVAILABILITY											
AG	EF	P	PRP	ST	SM	SG	ZR	XRAC	ZRAC	CP1	CPRO
								✓		✗	↻

ALSO AVAILABLE

SHAPE	TH. MM	NOTES
FDB2007	8.7	

Pinze / Calipers

BREMBO

4-Piston/2 pads; Narrow (GP32/36-mono), 10mm GP4 RR (code XA93310/11)

PVM

4-Piston, mono blok, 2pad x 10mm

CROSS REFERENCE

CL BRAKES	2329
EBC	FA218/2
LUCAS/TRW	MCB715
NEWFREN	FD0339
SBS	711
VESRAH	VD-969/2

MOTORCYCLE	CC	KW	FROM	TO	FRONT	
					REAR	RIGHT
HUSQVARNA	M	SMR 650	650	2007	F	

MOTORCYCLE	CC	KW	FROM	TO	FRONT	
					REAR	RIGHT
MOTO GUZZI	M	V12 LM	1200	2010	F	

M = MOTORCYCLE
S = SCOOTER
A = ATV
Sn = SNOWMOBILE

FDB2124

81.7 x 46.2 x 9.0 mm

MATERIAL AVAILABILITY											
AG	EF	P	PRP	ST	SM	SG	ZR	XRAC	ZRAC	CP1	CPR0
		✓		✓							

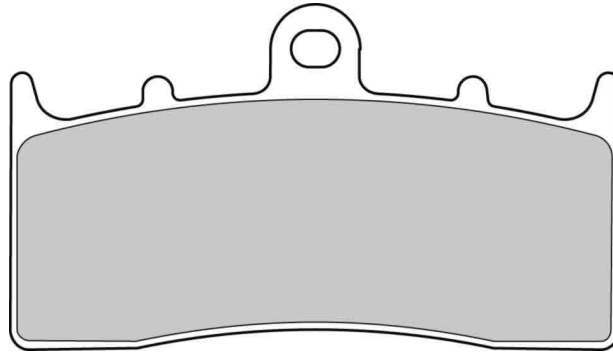

CROSS REFERENCE	
BRAKING	879
BREMBO	07GR62
BRENTA	4124
CL BRAKES	2960
EBC	FA294
EBC	FA613
GALFER	FD272
GOLD FREN	194
LUCAS/TRW	MCB736
NEWFREN	FD0319
SBS	778
VESRAH	VD-439
VESRAH	VD-439/2

		CC	KW	FROM	TO	FRONT / REAR	LEFT / RIGHT
	M R 850 R	850		2001		F	
	M R 1100 S ABS	1100		2001		F	
	M R 1150 R	1150		2001		F	
	M R 1150 R ROADSTER	1150		2001		F	
	M K 1200 LT (K589)	1200	72	2001	2003	F	
	M K 1200 LT (K589)	1200	85	2003	2008	F	
	M K 1200 RT	1200		2008		F	
	M R 1200 C CLASSIC	1200		2003		F	
	M R 1200 CL	1200		2003		F	
	M R 1200 C MONTAUK	1200		2004		F	

		CC	KW	FROM	TO	FRONT / REAR	LEFT / RIGHT
	M R 1200 R (R1ST)	1200	80	2006		F	
	M R 1200 R (R1ST)	1200	79	2006		F	
	M R 1200 R (R1ST)	1200	72	2006		F	
	M K 1300 R	1300		2009		F	
	M K 1600 GT	1600		2011		F	
	M K 1600 GTL	1600		2011		F	
	M K 1600 B Grand America	1600		2018		F	
	M K 1600 B	1649		2017		F	
	M ZRX 400 (ZR 400 E2)	400		1999	2001	F	

FDB2125

77.6 x 51.8 x 8.5 mm

Pad does not allow fitment of wear indicators for K1200 and K1300 2008-> models

MATERIAL AVAILABILITY											
AG	EF	P	PRP	ST	SM	SG	ZR	XRAC	ZRAC	CP1	CPRO
		✓		✓							

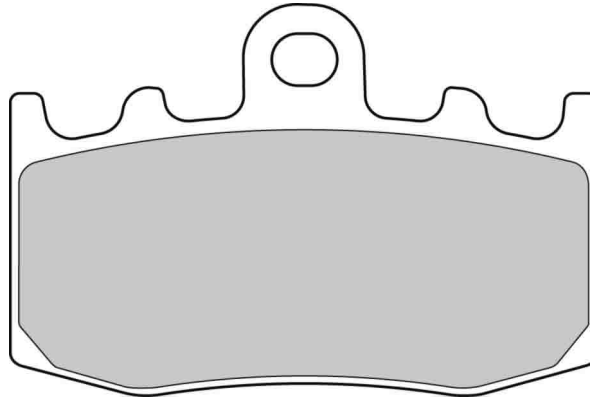

CROSS REFERENCE	
BRAKING	892
BREMBO	07BB26
BRENTA	4123
CL BRAKES	1101
EBC	FA335
EBC	FA441
GALFER	FD271
GOLD FREN	196
LUCAS/TRW	MCB748
NEWFREN	FD0320
SBS	796
VESRAH	VD-9000

		CC	KW	FROM	TO	FRONT REAR	LEFT RIGHT
	BMW						
	M	R 850 RT	850		2002 2003	F	
	M	R 1100 S (no ABS)	1100		2001	F	
	M	R 1150 RT	1150		2001	F	
	M	R 1150 RS	1150		2002	F	
	M	R 1150 GS ADVENTURE	1150		2003	F	
	M	HP2 Megamoto 1200	1200		2008	F	
	M	K 1200 S	1200		2004	F	
	M	K 1200 R	1200		2004	F	
	M	K 1200 GT	1200		2003 2007	F	
	M	K 1200 GT	1200		2007	F	
	M	K 1200 RS	1200		2002	F	
	M	R 1200 ST	1200		2005 2007	F	
	M	R 1200 RT (K26)	1200	79	2006 2013	F	

		CC	KW	FROM	TO	FRONT REAR	LEFT RIGHT
	M	R 1200 S	1200		2006 2008	F	
	M	R 1200 GS (R12)	1200	72	2004 2012	F	
	M	R 1200 GS (R12)	1200	74	2004 2012	F	
	M	R 1200 GS Adventure (R12)	1200	74	2004 2012	F	
	M	R 1200 GS Adventure (K25)	1200	72	2006 2012	F	
	M	R 1200 GS Adventure Triple Black (K25)	1200	81	2006 2012	F	
	M	R 1200 GS Adventure (K25)	1200	77	2007 2009	F	
	M	R 1200 GS (K25)	1200	77	2008 2009	F	
	M	R 1200 GS (K25)	1200	81	2009 2012	F	
	M	R 1200 GS Adventure (K25)	1200	81	2009 2012	F	
	M	K 1300 GT	1300		2009	F	
	M	K 1300 S	1300		2009	F	
	M	K 1300 S Motorsport	1300		2015	F	

M = MOTORCYCLE
S = SCOOTER
A = ATV
Sn = SNOWMOBILE

FDB2126

100.3 x 39.3 x 12.0 mm

MATERIAL AVAILABILITY											
AG	EF	P	PRP	ST	SM	SG	ZR	XRAC	ZRAC	CP1	CPR0
	✓	✓			✓						

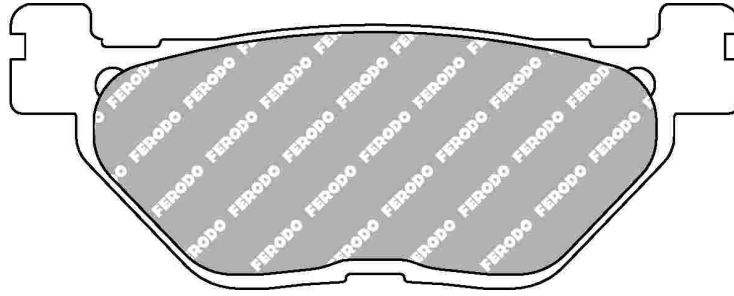

ALSO AVAILABLE		
SHAPE	TH. MM	NOTES
FDB2156	9.5	

CROSS REFERENCE	
BRAKING	868
BREMBO	07052
BREMBO	7052
BRENTA	3058
BRENTA	4058
EBC	SFA319
GALFER	FD260
GOLD FREN	165
LUCAS/TRW	MCB722
NEWFREN	FD0316
SBS	169
VESRAH	VD-269
VESRAH	VD-275

		CC	KW	FROM	TO	FRONT / REAR	LEFT / RIGHT
	SYM						
	S	Voyager 250	250	2005	2005	R	
	YAMAHA						
	M	TMAX 500 (5SJ1)	500	29	2001	2003	R
	M	TMAX 530	530		2012		R
	M	TMAX 530 ABS	530		2012		R
	M	TMAX 530 IRON MAX /ABS	530		2015		R
	S	TMAX 530 LUX MAX /ABS	530		2016		R

		CC	KW	FROM	TO	FRONT / REAR	LEFT / RIGHT
	S	TMAX 530 DX ABS	530		2017		R
	S	TMAX 530 SX ABS	530		2018		R
	S	TMAX 530 SX ABS SPORT EDITION	530		2018		R
	S	TMAX 560	560		2020		R
	S	TMAX 560 Tech	560		2020		R

FDB2127

36.0 x 39.2 x 6.0 mm

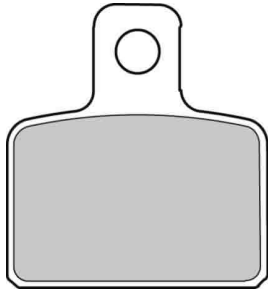

MATERIAL AVAILABILITY											
AG	EF	P	PRP	ST	SM	SG	ZR	XRAC	ZRAC	CP1	CPR0
						✓					

CROSS REFERENCE	
BRAKING	832
BREMBO	07GR48
BRENTA	3042
BRENTA	4042
EBC	FA351
EBC	FA471
GALFER	FD224
LUCAS/TRW	MCB767
NEWFREN	FD0315
SBS	803
VESRAH	VD-9003

		CC	KW	FROM	TO	FRONT / REAR	LEFT / RIGHT	
	BETA	M	MINICROSS 50 PRO RACE 12/10	50	2004	2006	F	
		M	MINICROSS 50 PRO RACE 12/10	50	2004	2006	R	
		M	Minitrial 50	50	2009	2012	F	
		M	Pro Race 50	50	2005		R	
GASGAS	M	TXT 80 KADET PRO	80	2006	2014	F		
	M	TXT 80 KADET PRO	80	2006	2014	R		
	M	TXT 80 ROOKIE	80	2006	2013	R		
	M	TXT 80 PRO Racing	80	2015	2020	R		
	M	TXT 125 / 200 / 250 / 280 / 300	125	2004		R		
HUSQVARNA	M	CR 50 Junior	50	2005		F		
	M	CR 50 Senior Pro	50	2005		F		
	M	TE 100	100	2005		F		
MONTESA (HONDA)	M	COTA 250 4RT	250	2005	2010	R		
	M	4 RIDE 260	260	2016		R		
	M	COTA 260 4RT	260	2014		R		
	M	MH 315 R	315	2001	2004	R		
SCORPA	M	SR 125 (2T)	125	2010	2013	R		
	M	SR 125 Long Ride (2T)	125	2010	2011	R		
	M	SY 125 (4T) Long Ride	125	2009	2010	R		
	M	TY 125 (4T)	125	2011	2013	R		
	M	SY 200 F (4T) (163cc)	200	2008	2008	R		

		CC	KW	FROM	TO	FRONT / REAR	LEFT / RIGHT
	M	SY 250 F (4T) Long Ride	250	2007	2008	R	
	M	SY 250 FR (4T) Long Ride	250	2010	2010	R	
	M	SR 280 (2T)	280	2009		R	
	M	SR 280 (2T) Long Ride	280	2009	2011	R	
	M	Raidster 660	660	2007		R	
SHERCO	M	ST80 (2T)	80	2013	2014	R	
	M	Trials 0.8 (2T)	80	2001	2004	R	
	M	Trials 0.8 (2T) AJP CALIPER	80	2005	2010	R	
	M	ST125 (2T)	125	2013	2014	R	
	M	ST125 (2T) AJP CALIPER	125	2015		R	
	M	Trials 1.25cc (2T) AJP CALIPER	125	2006	2011	R	
	M	XY	125	2014		R	
	M	ST250 (2T)	250	2013	2014	R	
	M	ST250 (2T) AJP CALIPER	250	2015		R	
	M	Trials 2.5 (2T) AJP CALIPER	250	2006	2011	R	
	M	ST290 (2T)	290	2013	2014	R	
	M	Trials 2.9 (2T) AJP CALIPER	290	2006	2011	R	
M	ST300 (2T)	300	2013	2014	R		
M	ST300 (2T) AJP CALIPER	300	2015		R		
M	Trials 3.2cc (4T) AJP CALIPER	320	2005	2011	R		

M = MOTORCYCLE
 S = SCOOTER
 A = ATV
 Sn = SNOWMOBILE

FDB2128

50.3 x 47.5 x 7.0 mm

Novembre 2016: AG superseded by EF

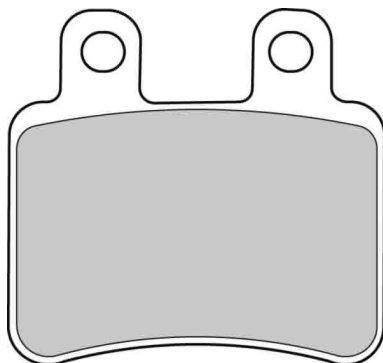

MATERIAL AVAILABILITY											
AG	EF	P	PRP	ST	SM	SG	ZR	XRAC	ZRAC	CP1	CPRO
X	✓										

CROSS REFERENCE	
BRAKING	878
BREMBO	07048
BREMBO	7048
BRENTA	3048
BRENTA	4048
EBC	FA350
GALFER	FD270
GOLD FREN	211
LUCAS/TRW	MCB735
NEWFREN	FD0323
SBS	167
SBS	773
VESRAH	VD-999

		CC	KW	FROM	TO	FRONT REAR	LEFT RIGHT
	DERBI	M SENDA DRD Pro 50 SM	50	2008		R	
		M BOULEVARD 125 / 150	125	2003		F	
		M Cross City 125	125	2007	2008	R	
		M Cross City 125	125	2009		R	
		M SENDA BAJA 125 SM	125	2008		R	
		M TERRA 125 ADVENTURE	125	2008	2009	R	
		S Atlantis 150	150	2004		F	
		M FUOCO 500 ie	500	2011		R	
		M GP800	800	2011		R	
	HONDA-HM ITALIA	M CRE 50	50	2006		R	
	ITALJET	M MILLENIUM 100	100	2002	2003	F	
		M JET SET 125	125	2002	2003	F	
		M MILLENIUM 125	125	2001	2003	F	
		M JET SET 150	150	2002	2003	F	
		M MILLENIUM 150	150	2001	2003	F	
	PEUGEOT	M ELYSEO 125	125	2001	2002	F	
		M ELYSEO 125	125	2003		R	
		S Elystar 125 (5 bolt fixing front disc)	125	2006	2007	R	
		S Geopolis 125 (AJP Caliper/ABS)	125	2007	2012	R	
		S Geopolis 125 Executive (AJP Caliper/Non ABS)	125	2007	2012	R	
		S Geopolis 125 Urban (AJP Caliper/ ABS)	125	2007	2012	R	
		S SATELIS 125	125	2004	2005	R	
		S Satelis 125 4V Executive/Premium/City	125	2006	2009	R	
		S Satelis 125 Compressor (4T)	125	2006	2011	R	
		S Satelis 125 RS (AJP Caliper)	125	2007	2011	R	
		S Satelis 125 Urban (AJP Caliper/ABS)	125	2007	2011	R	
		S Satelis 125 Blacksat (AJP Calipers)	125	2010	2011	R	

		CC	KW	FROM	TO	FRONT REAR	LEFT RIGHT
	S	Satelis 125 Whitesat (AJP Calipers)	125	2010	2011	R	
	M	ELYSEO 150	150	2000		R	
	M	ELYSEO 150	150	2001		R	
	S	Elystar 150 (5 bolt fixing front disc)	150	2006	2007	R	
	S	Geopolis 250 Executive (AJP caliper/ Non ABS)	250	2007	2011	R	
	S	Geopolis 250 Urban (AJP caliper/ ABS)	250	2007	2011	R	
	S	Satelis 250 Urban (AJP Caliper/ABS)	250	2007	2012	R	
	S	Geopolis 400 Urban (AJP Caliper/ ABS)	400	2007	2012	R	
	S	SATELIS 600	600	2004	2005	R	
	RIEJU	M TANGO 50	50	2013	2015	R	
		M TANGO 125	125	2011		R	
		M TANGO 250	250	2012	2013	R	
	SCORPA	M T-Ride 125 F (Enduro)	125	2010		R	
		M T-Ride 250 F (Enduro)	250	2008	2011	R	
	SHERCO	M Enduro 50c (2T)/Urban/SU - Spoke wheel models)	50	2008	2013	R	
		M SM 0.5cc Black Panther	50	2008	2010	R	
		M SU 50 (2T) Urban Base - Cast wheel model)	50	2010		R	
		M Supermotard 50cc (2T)	50	2008	2013	R	
		M City Corp 125 (All models)	125	2008		R	
		M SE 1.25 F Enduro (4T)	125	2010	2012	R	
		M SM 1.25 i F Black Panther (4T)	125	2010	2012	R	
	YAMAHA	M DT 50 R SM	50	2004		R	
		M DT 50 X	50	2008		R	
		M XT 125 R	125	2008		F	
		M XT 125 R	125	2008		R	
		M XT 125 X	125	2008		R	

FDB2129

105.3 x 44.2 x 7.9 mm / 66.1 x 36.9 x 12.7 mm

October 2019: AG Out of range

MATERIAL AVAILABILITY											
AG	EF	P	PRP	ST	SM	SG	ZR	XRAC	ZRAC	CP1	CPRO
						!					

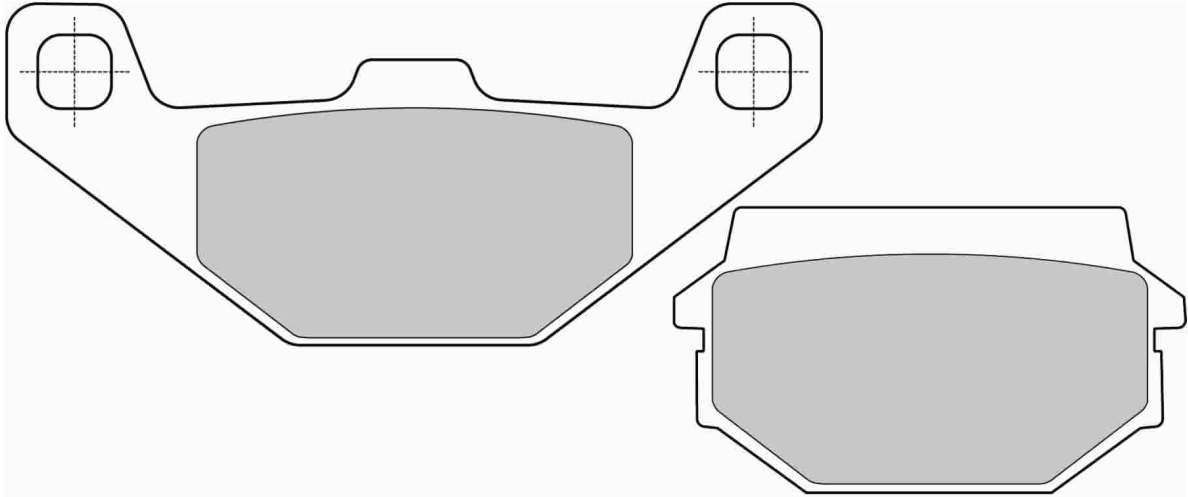

CROSS REFERENCE	
BREMBO	07023
BREMBO	7023
EBC	FA297
LUCAS/TRW	MCB719
NEWFREN	FD0296
SBS	745
VESRAH	VD-9019

		CC	KW	FROM	TO	FRONT / REAR	LEFT / RIGHT
	SYM M HUSKY 125	125		2000		F	

		CC	KW	FROM	TO	FRONT / REAR	LEFT / RIGHT
	M HUSKY 150	150		2000		F	

FDB2130

86.1 x 40.2 x 8.9 mm

MATERIAL AVAILABILITY

AG	EF	P	PRP	ST	SM	SG	ZR	XRAC	ZRAC	CP1	CPRO
✓											

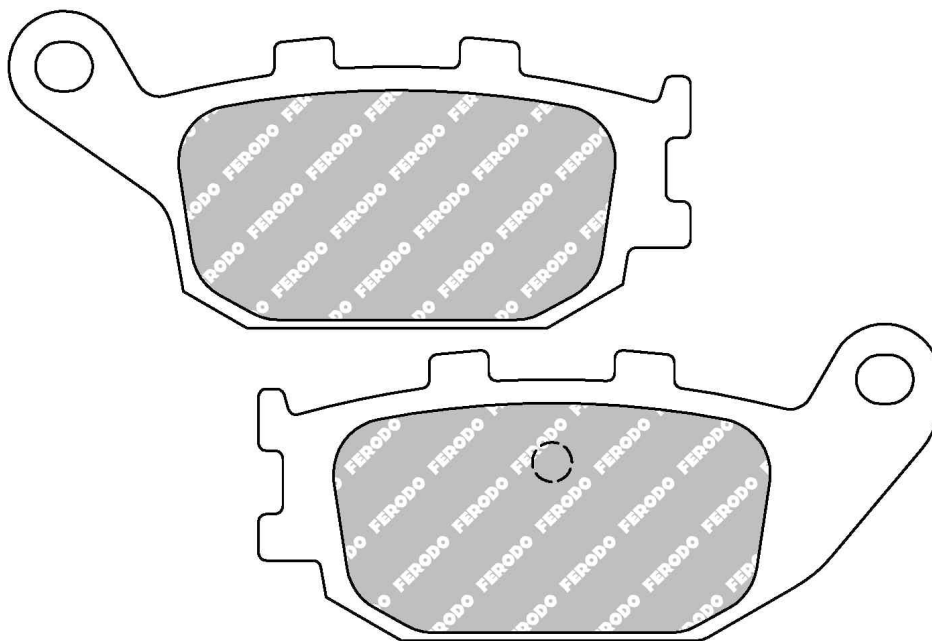

CROSS REFERENCE

BREMBO	07053
BREMBO	7053
EBC	FA358
EBC	SFA358
NEWFREN	FD0324
SBS	158
VESRAH	VD-169



HONDA

S JAZZ 250

CC	KW	FROM	TO	FRONT REAR	LEFT RIGHT
250		2001		R	

FDB2132

81.2 x 42.2 x 8.3 mm



June 2018: AG superseded by EF; with pin 3mm on the backplate

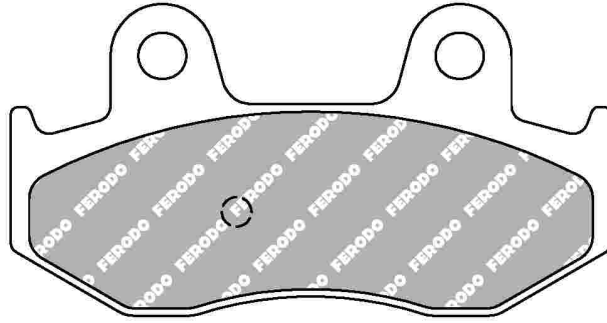

MATERIAL AVAILABILITY											
AG	EF	P	PRP	ST	SM	SG	ZR	XRAC	ZRAC	CP1	CPRO
	✓			✗							



ALSO AVAILABLE		
SHAPE	TH. MM	NOTES
FDB382	7.5	no pin on the backplate
FDB2086	8.0	no pin on the backplate
FDB2119	9.0	no pin on the backplate

CROSS REFERENCE	
BRAKING	887
BREMBO	07055
BREMBO	7055
BRENTA	3047
BRENTA	4047
CL BRAKES	3074
EBC	FA411
EBC	SFA411
GOLD FREN	267
LUCAS/TRW	MCB746
NEWFREN	FD0326
SBS	174
SBS	781
VESRAH	VD-356

		CC	KW	FROM	TO	FRONT / REAR	LEFT / RIGHT
	KAWASAKI	M	SC 250 EPSILON	250		2002	R
	SUZUKI	M	AN 250 BURGMAN K1/K2	250		2001	2002 R

		CC	KW	FROM	TO	FRONT / REAR	LEFT / RIGHT
	M	AN 250 K3-K6 BURGMAN (CJ43A)	250		2003	2006	R
	M	AN 400 BURGMAN	400		2001	2006	R

M = MOTORCYCLE
S = SCOOTER
A = ATV
Sn = SNOWMOBILE

FDB2133

75.7 x 41.5 x 8.2 mm / 99.2 x 40.3 x 7.5 mm

April 2019: AG superseded by EF

MATERIAL AVAILABILITY											
AG	EF	P	PRP	ST	SM	SG	ZR	XRAC	ZRAC	CP1	CPRO
✗	✓					✓					

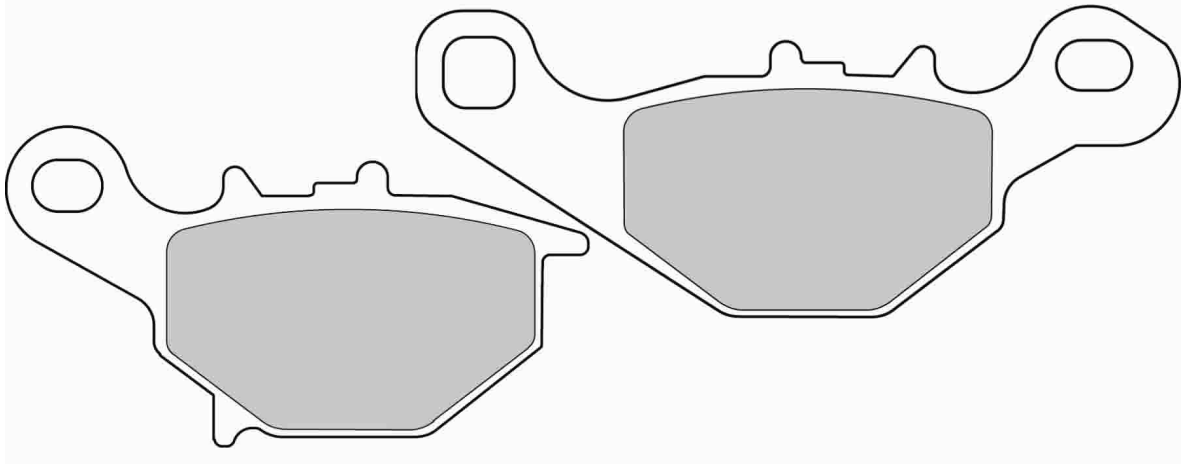

ALSO AVAILABLE		
SHAPE	TH. MM	NOTES
FDB2197		Coupled set

CROSS REFERENCE	
BRAKING	785
BREMBO	07036
BREMBO	7036
CL BRAKES	2914
EBC	FA230
EBC	FA396
GALFER	FD177
LUCAS/TRW	MCB679
LUCAS/TRW	MCB772
NEWFREN	FD0222
SBS	702
VESRAH	VD-351

		CC	KW	FROM	TO	FRONT / REAR	LEFT / RIGHT
	M KLX 125 L	125		2003	2006	F	
	M KMX 125	125		1999	2003	F	
	M TR 50 STREET MAGIC	50		1998	2000	F	
	M RM 80 XT - XV - X	80		1996	2001	F	
	M RM 85 L	85		2002	2004	F	
	S ADDRESS 110	110		2015		F	
	M UG 110 HOKUTO	110		2000	2004	F	
M AN 125	125		1995	2000	F		

		CC	KW	FROM	TO	FRONT / REAR	LEFT / RIGHT
	M DR-Z 125	125		2003		F	
	M UE - 125 EPICURO	125		1998	2000	F	
	M UE - 125 EPICURO	125		2001	2002	F	
	M UE - 125 EPICURO	125		2001	2002	R	
	M UC 150 EPICURO	150		1998	2000	F	
	M UC 150 EPICURO	150		2001	2002	F	
	M UC 150 EPICURO	150		2001	2002	R	

FDB2136

61.8 x 56.6 x 11.5 mm

MATERIAL AVAILABILITY											
AG	EF	P	PRP	ST	SM	SG	ZR	XRAC	ZRAC	CP1	CPRO
						✓					

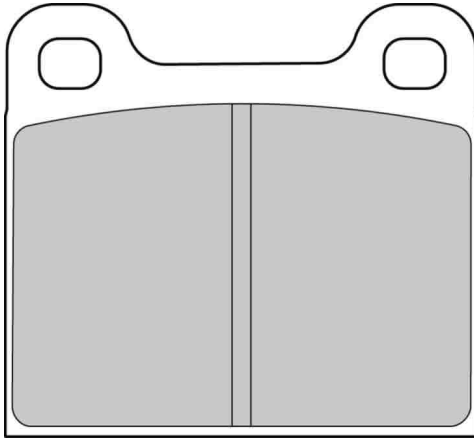

CROSS REFERENCE	
NEWFREN	FD0274

		CC	KW	FROM	TO	FRONT / REAR	LEFT / RIGHT
 LYN SNOWMOBILE	Sn Enduro			1998	2000	R	
	Sn GLX 5009 ST			1998	2000	R	

		CC	KW	FROM	TO	FRONT / REAR	LEFT / RIGHT
 Ssn	Rave Special			1998	2000	R	
	Gran Touring 700	700		1998	2000	R	

FDB2139

60.2 x 44.2 x 11.0 mm

MATERIAL AVAILABILITY											
AG	EF	P	PRP	ST	SM	SG	ZR	XRAC	ZRAC	CP1	CPRO
	✓	✓				✓					

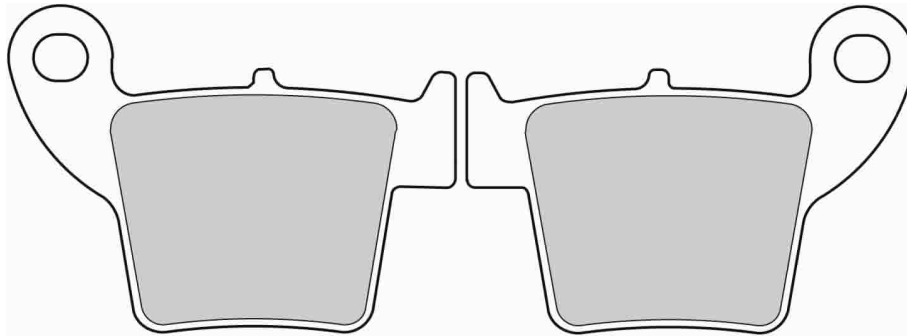

CROSS REFERENCE	
BRAKING	886
BREMBO	07HO48
BRENTA	3046
BRENTA	4046
CL BRAKES	1076
EBC	FA346
GALFER	FD278
GOLD FREN	176
NEWFREN	FD0329
SBS	777
VESRAH	VD-168

		CC	KW	FROM	TO	FRONT / RÉAR	LEFT / RIGHT
							
APRILIA	M MXV 450	450		2008		R	
FANTIC	M 50E (2T) Enduro Casa	50		2013		R	
	M 50ER (2T) Enduro Competizione	50		2013		R	
	M 50M (2T) Motard Casa	50		2013		R	
	M 50MR (2T) Motard Competizione	50		2013		R	
	M TX 180 E (49cc/2T) Regolarita Casa 50E	50		2011	2013	R	
	M TX 180 ER (49cc/2T) Regolarita Competizione 50ER	50		2011	2013	R	
	M TX 180 ES (49cc/2T) Regolarita Scuderia 50ES	50		2011	2013	R	
	M TX 180 SM (49cc/2T) Motard Casa 50M	50		2011	2013	R	
	M TX 180 MR (49cc/2T) Motard Competizione 50MR	50		2011	2013	R	
	M Caballero Flat Track	125		2017		R	
	M Caballero Scrambler	125		2017		R	
	M 125 E (4T)Enduro Casa	125		2013		R	
	M 125 M (4T)Motard Casa	125		2013		R	
	M 125 MR (4T)Motard Competizione	125		2013		R	
	M TR 125 CR (2T) Cross Competizione	125		2013		R	
	M TR 125 MR (2T) Motard Competizione	125		2013		R	
	M TZ 125 CS (2T) Caballero Cross	125		2011	2012	R	
	M TZ 125 ES (2T) Regolarita Scuderia	125		2011	2012	R	
	M TZ 125 SM (2T) Caballero Motard	125		2011	2012	R	
	M TZ 170 E (125 E / 4T) Regolarita Casa	125		2011	2013	R	
	M TZ 170 ER (125 ER / 4T) Caballero Reg. Comp.	125		2011	2013	R	
	M TZ 170 SM (125 SM/ 4T) Motard Casa	125		2011	2013	R	
	M 200 ER (4T)Enduro Competizione	200		2011		R	
	M 200 MR (4T)Motard Competizione	200		2011		R	
	M TZ 200 ER (200 ER / 4T) Caballero Reg. Comp.	200		2011	2013	R	
	M TZ 200 MR (200 MR / 4T) Motard	200		2011	2013	R	
	M Caballero Flat Track 250	249		2019		R	

		CC	KW	FROM	TO	FRONT / RÉAR	LEFT / RIGHT
							
	M Caballero Scrambler 250	249		2019		R	
	M TF 250 ES (4T)	250		2011	2013	R	
	M TR 250 ES (2T) Enduro Six Day	250		2013		R	
	M TR 300 ES (2T) Enduro Six Day	300		2013		R	
	M TZ 300 ES Regolarita Scuderia	300		2011	2012	R	
HONDA	M CR 125 R	125		2002	2007	R	
	M CRF 150 R (Small wheel 17"-14")	150		2007	2015	R	
	M CRF 150 R (Big wheel 19"-16")	150		2007	2015	R	
	M CR 250 R	250		2002	2007	R	
	M CRF 250 R	250		2004		R	
	M CRF 250 X	250		2004	2017	R	
	M CRF 450 SUPERMOTARD	450		2002		R	
	M CRF 450 L	450	18	2019		R	
	M CRF 450 R	450		2002		R	
	M CRF 450 R	450		2017		R	
	M CRF 450 RX	450		2017		R	
	M CRF 450 X	450		2005	2013	R	
HONDA-HM ITALIA	M CRE 125 2T /Six Comp	125		2002		R	
	M CRE Baja RR HM 125 2T	125		2011		R	
	M CRE 250 / CRE F250 X/R	250		2002		R	
	M CRE F300 X	300		2008		R	
	M CRE F450 X/R	450		2008		R	
	M CRE F450 R	450		2011		R	
	M CRM F 450 R	450		2008		R	
	M CRM F 450 X	450		2008		R	
	M CRE F500 X	500		2009		R	
SUZUKI	M RME 50 R	50		2010		R	

FDB2140

55.6 x 46.0 x 7.0 mm

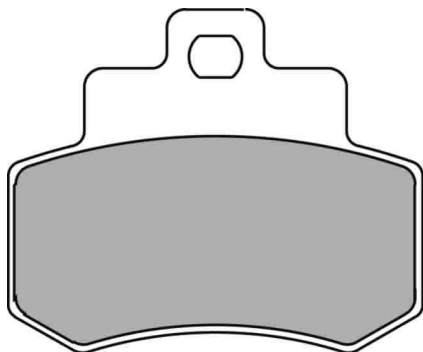

MATERIAL AVAILABILITY

AG	EF	P	PRP	ST	SM	SG	ZR	XRAC	ZRAC	CP1	CPRO
✓											

CROSS REFERENCE

BRAKING	884
BREMBO	07051
BREMBO	7051
BRENTA	3036
BRENTA	4036
EBC	FA356
EBC	SFA356
GALFER	FD276
LUCAS/TRW	MCB733
NEWFREN	FD0328
SBS	776
VESRAH	VD-988



		CC	KW	FROM	TO	FRONT / REAR	LEFT / RIGHT
KYMCO	M GRAND DINK 250	250		2001		R	

FDB2141

44.6 x 51.2 x 7.0 mm

December 2016: AG superseded by EF (Set=4 Pads)

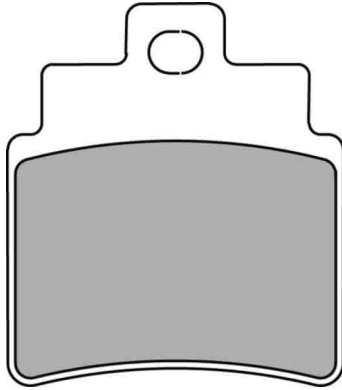

MATERIAL AVAILABILITY

AG	EF	P	PRP	ST	SM	SG	ZR	XRAC	ZRAC	CP1	CPRO
✗	✓					✓					

CROSS REFERENCE

BRAKING	883
BREMBO	07050
BREMBO	07GR71
BREMBO	7050
BRENTA	3037
BRENTA	4047
CL BRAKES	1151
EBC	FA355
GALFER	FD275
GOLD FREN	140
LUCAS/TRW	MCB732
NEWFREN	FD0327
SBS	171
SBS	775
VESRAH	VD-987



		CC	KW	FROM	TO	FRONT / REAR	LEFT / RIGHT
ARCTIC CAT	A 250 DVX	250		2006	2008	R	
	A 300 DVX	300		2009	2010	R	
KYMCO	M GRAND DINK 250	250		2001		F	
KYMCO ATV	A KXR 250 MONGOOSE	250		2004	2009	R	
	A MXU 250	250		2004	2013	R	
	A URBAN 250	250		2006	2007	R	
	A MAXXER 300	300		2006	2013	R	
	A Mongoose 300	300		2006	2010	R	



		CC	KW	FROM	TO	FRONT / REAR	LEFT / RIGHT
SYM	S GTS 125 i	125		2010	2015	F	
	S GTS 250	250		2007	2008	F	
	S Joymax 250 i GTS (All Models)	250		2009	2015	F	
	S JOYMAX 250	250		2006	2007	F	
	S Joymax 250 i	250		2007	2008	F	
	S Voyager 250	250		2005	2005	F	
	S Joymax 300 GTS (All Models)	300		2008	2015	F	

M = MOTORCYCLE
S = SCOOTER
A = ATV
Sn = SNOWMOBILE

FDB2142

97.1 x 41.2 x 9.0 mm / 77.2 x 41.2 x 9.0 mm

MATERIAL AVAILABILITY											
AG	EF	P	PRP	ST	SM	SG	ZR	XRAC	ZRAC	CP1	CPRO
✓	✓			✓	✓						

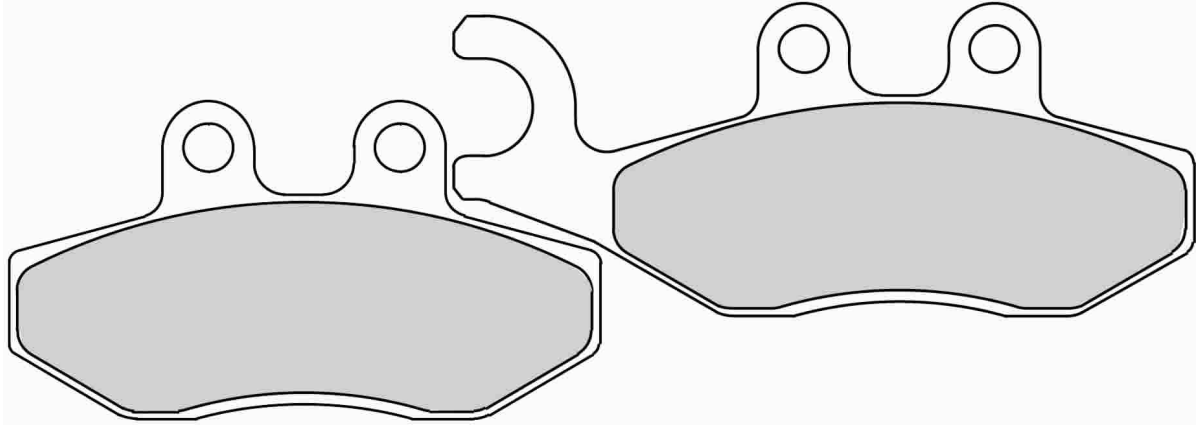

ALSO AVAILABLE		
SHAPE	TH. MM	NOTES
FDB2186		Coupled set

CROSS REFERENCE	
BRAKING	888
BREMBO	07056
BREMBO	7056
BRENTA	3041
BRENTA	4041
CL BRAKES	3060
EBC	FA353
EBC	SFA353
GALFER	FD277
GOLD FREN	293
LUCAS/TRW	MCB744
NEWFREN	FD0330
SBS	177
SBS	786
VESRAH	VD-983

		CC	KW	FROM	TO	FRONT REAR	LEFT RIGHT			
	APRILIA	S	Sport City One 50 (2T)	50		2008	2011	F		
		S	Sport City One 50 (4T)	50		2008	2009	F		
		S	SR MOTARD 50	50		2012		F		
		M	SPORTCITY ONE 125	125		2010		F		
		S	SR MAX 125	125		2011		F		
		S	SR MAX 125	125		2011		R		
		S	SR MOTARD 125	125		2012		F		
		M	SX 125	125		2018		F		
		S	SR MAX 300	300		2011		F		
		S	SR MAX 300	300		2011		R		
		S	SRV 850 ABS ATC	850		2013		R		
		DERBI	M	GP800	800		2010	2010	R	
		GILERA	S	RUNNER 50 SP / SKP	50		2006		F	
		M	NEXUS 250 IE	250		2007		F		
		M	NEXUS 250 IE	250		2007		R		
		M	NEXUS 300 (M35)	300	16	2008	2013	F		
		M	NEXUS 300 (M35)	300	16	2008	2013	R		
		M	FUOCO 500 RC/ie	500		2007		R		
		M	GP800	800		2008		R		
	KEEWAY	S	K2 125/150/250	125		2007		F		
		S	K2 125/150/250	125		2007		R		
	PIAGGIO	M	FLY 50 2T	50		2005		F		

		CC	KW	FROM	TO	FRONT REAR	LEFT RIGHT	
	M	FLY 50 4T	50		2005		F	
	S	Liberty 50 (2T / 10 Spoke Cast Wheels)	50		2009	2013	F	
	S	Liberty 50 (4T / 10 Spoke Cast Wheels)	50		2009	2013	F	
	S	Typhoon 50 (2T/12" Wheels)	50		2010	2012	F	
	S	VESPA PRIMAVERA 50 2T	50		2014		F	
	S	VESPA PRIMAVERA 50 4T 4V	50		2014		F	
	S	VESPA SPRINT 50 (2T 2V)	50		2014		F	
	S	VESPA SPRINT 50 (4T 4V)	50		2014		F	
	S	VESPA SPRINT 125 (4T 3V) i.e. ABS	50		2014		F	
	S	Fly 100 (4T)	100		2007	2012	F	
	M	Beverly 125 (M28) - Heng Tong caliper	125	11	2001	2006	F	
	M	Beverly 125 (M28) - Heng Tong caliper	125	11	2001	2006	R	
	S	Beverly 125	125		2007	2007	F	
	S	Beverly S 125	125		2007	2007	F	
	S	Beverly S 125	125		2007	2007	R	
	S	Beverly Tourer 125 (M28)	125	11	2008	2009	F	
	S	Beverly Tourer 125 (M28)	125	11	2008	2009	R	
	S	Beverly RST 125 i.e. (4T 4V)(M69)	125	11	2010	2014	F	
	M	CARNABY 125	125		2008		F	
	M	CARNABY 125	125		2008		R	
	M	FLY 125	125		2004	2006	F	
M	SKIPPER ST 125 (Heng Tong caliper)	125		2000		F		



		CC	KW	FROM	TO	FRONT / REAR	LEFT / RIGHT
M	SUPER HEXAGON 125 GTX	125		2001		F	
S	Typhoon 125 (4T/12" Wheels)	125		2010	2012	F	
M	VESPA GRANTURISMO 125 (Heng Tong caliper)	125		2003		F	
S	Vespa GTS 125	125		2007	2011	F	
S	Vespa GTV 125	125		2007	2009	F	
S	Vespa GTS 125 Super 4T i.e.	125		2010	2013	F	
S	VESPA PRIMAVERA 125 4T 3V i.e.	125		2013		F	
S	Vespa GTS 125 i.e. Supersport	125		2013	2013	F	
S	Vespa GTS 125 Super 4T i.e. ABS	125		2015		F	
S	VESPA PRIMAVERA 125 4T 3V i.e. ABS	125		2015		F	
S	VESPA 125 GTS i.e. ABS E4	125		2016	2017	F	
S	Vespa GTS 125 Liquid cooled	125		2017		F	
M	X9 125 Evolution	125		2004		F	left
M	X8 125	125		2005		F	
S	X8 125 ie	125		2007		F	
S	X7 125cc	125		2008	2009	F	
S	X7 Evo 125 ie (Efi)	125		2009	2012	F	
S	X10 125 i.e. (4T 4V)	125		2012		F	left
S	X10 EXECUTIVE (ABS-ASR) 125 i.e. (4T 4V)	125		2013		F	left
S	Xevo 125	125		2007	2012	F	
M	FLY 150	150		2006	2008	F	
M	SKIPPER ST 150 (Heng Tong caliper)	150		2000		F	
M	SUPER HEXAGON 150 GTX	150		2001		F	
S	VESPA PRIMAVERA 150 3V	150		2014		F	
S	VESPA 150 GTS i.e. ABS E4	150		2016	2017	F	
M	SUPER HEXAGON 180 GTX	180		2001	2003	F	
M	BEVERLY B 200 (Heng Tong caliper)	200		2002	2006	F	
M	BEVERLY B 200 (Heng Tong caliper)	200		2002	2006	R	
S	Carnaby 200	200		2007	2009	F	
S	Carnaby 200	200		2007	2009	R	
M	VESPA GRANTURISMO 200 (Heng Tong caliper)	200		2003		F	
M	X8 200	200		2004		F	
M	BEVERLY 250 i.e.	250		2006	2008	F	
M	BEVERLY 250 i.e.	250		2006	2008	R	
S	Beverly Sport 250 i.e.	250		2006	2008	F	
S	Beverly Sport 250 i.e.	250		2006	2008	R	
M	BEVERLY Tourer 250 i.e.	250		2007	2009	F	
M	BEVERLY Tourer 250 i.e.	250		2007	2009	R	



		CC	KW	FROM	TO	FRONT / REAR	LEFT / RIGHT
S	Beverly Cruiser 250 i.e.	250		2007	2009	F	
S	Beverly Cruiser 250 i.e.	250		2007	2009	R	
S	Carnaby 250 ie	250		2008	2009	F	
S	Carnaby 250 ie	250		2008	2009	R	
M	VESPA GTS - GTV 250 ie	250		2008		F	
M	X9 250 Evolution	250		2005		F	left
M	X8 250	250		2006		F	
S	X8 250 ie	250		2007		F	
M	X-EVO 250 ie	250		2008		F	
M	GTV Via Montenapoleone 280	280		2010		F	
M	Beverly 300 i.e. Tourer (M28)	300	16	2009	2010	F	
M	Beverly 300 i.e. Tourer (M28)	300	16	2009	2010	R	
M	Beverly 300 i.e. RST (M69)	300	16	2010		F	
S	Beverly 300 by Police	300		2016		F	
M	CARNABY CRUISER 300 ie	300		2008		F	
M	CARNABY CRUISER 300 ie	300		2008		R	
S	Carnaby 300 ie	300		2012		F	
S	Carnaby 300 ie	300		2012		R	
M	VESPA GTS 300 Super	300		2008		F	
M	VESPA GTS 300 i.e. Supersport	300		2010	2013	F	
M	VESPA GTS 300 i.e. Touring	300		2011	2012	F	
M	VESPA GTS 300 i.e.	300		2012		F	
M	VESPA 300 GTS i.e. ABS E4	300		2016	2017	F	
M	X7 EVO 300	300		2010		F	
M	Beverly 350 (4T 4V)(M69) ABS	350	25	2011		F	
S	Beverly 350 i.e. Sport Touring	350	25	2014		F	
S	Beverly 350 Tourer	350		2020		F	
S	X10 350 i.e. (4T 4V)	350		2012		F	left
S	X10 EXECUTIVE (ABS-ASR) 350 i.e. (4T 4V)	350		2013		F	left
S	Beverly 400 i.e.	400		2007	2007	R	
S	MP3 400 ie	400		2007	2008	R	
M	X-EVO 400 ie	400		2008		F	left
S	MP3 500 i.e. LT Business ABS/ASR	500		2014		R	
S	MP3 500 i.e. Sport ABS/ASR	500		2014		R	
S	MP3 500 Business HPE	500	41	2018		R	
S	MP3 500 Sport HPE	500	41	2018		R	
S	X10 500 i.e. (4T 4V)	500		2012		F	left
S	X10 EXECUTIVE (ABS-ASR) 500 i.e. (4T 4V)	500		2013		F	left

M = MOTORCYCLE
S = SCOOTER
A = ATV
Sn = SNOWMOBILE

FDB2143

107.2 x 42.5 x 10.0 mm / 91.7 x 40.2 x 10.0 mm

MATERIAL AVAILABILITY											
AG	EF	P	PRP	ST	SM	SG	ZR	XRAC	ZRAC	CP1	CPRO
	✓	✓									

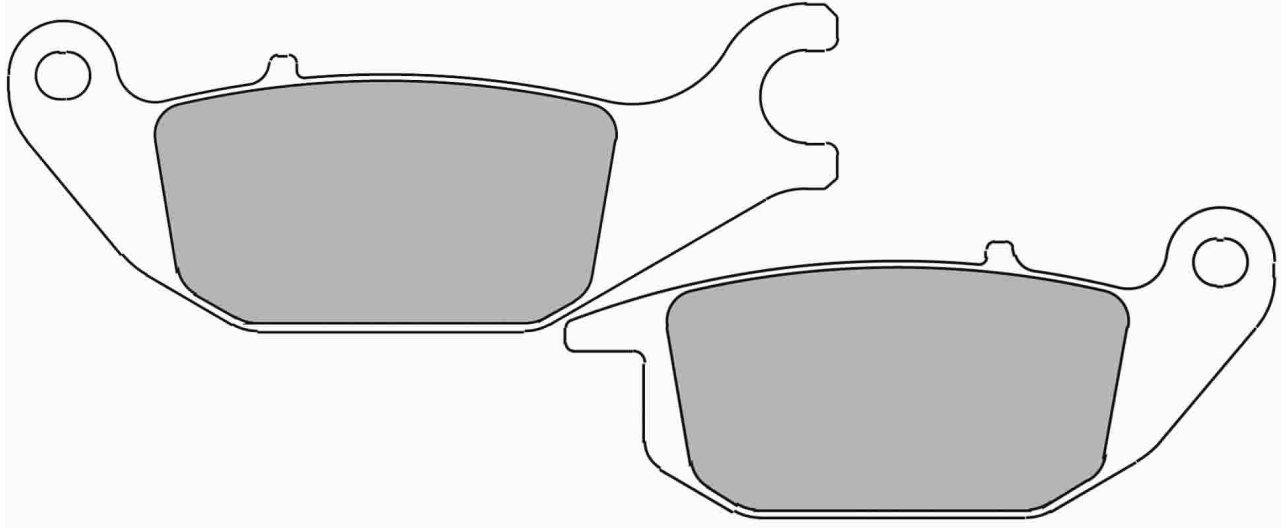

CROSS REFERENCE	
BRAKING	867
BREMBO	07HO49
BREMBO	7110
CL BRAKES	1067
DP (Dunlop) BRAKE	DP129
EBC	FA343
GALFER	FD259
GOLD FREN	221
NEWFREN	FD0331
SBS	784
VESRAH	VD-167

		CC	KW	FROM	TO	FRONT / REAR	LEFT / RIGHT
HERO	M Maestro	109	6	2016		R	
	M Karizma ZMR	220		2003		R	
	M Karizma ZMR	223	13	2009		R	
	M Karizma ZMR	223	15	2014		R	
	M Karizma ZMR	223	15	2016		R	
M Karizma ZMR 230	320		2011	2012	R		

		CC	KW	FROM	TO	FRONT / REAR	LEFT / RIGHT
HONDA	M CBR 125 R	125		2004	2010	R	
	M XL 125 VARADERO	125		2001		R	
	M CBR 150 R	150		2000	2003	R	
YAMAHA	S Tricity 125	125	8	2014		R	
	M YZF-R15 (Indian Model)	150		2008		R	
M YZF-R15	150		2011		R		

FDB2144

90.0 x 52.0 x 9.9 mm

MATERIAL AVAILABILITY											
AG	EF	P	PRP	ST	SM	SG	ZR	XRAC	ZRAC	CP1	CPRO
		✓		✓				✓			

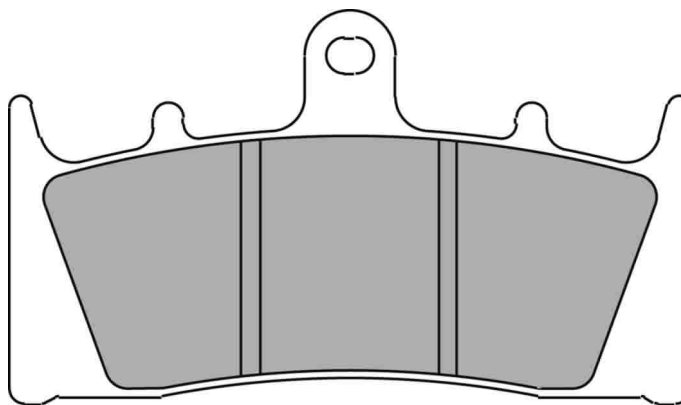

ALSO AVAILABLE		
SHAPE	TH. MM	NOTES
FDB873	8.0	

Pinze / Calipers

FD (Discacciati)

6-Piston - 9,5mm thick version

CROSS REFERENCE	
BREMBO	07SU19
CL BRAKES	2255
EBC	FA188
GOLD FREN	039
NEWFREN	FD0361
SBS	686
VESRAH	VD-349

		CC	KW	FROM	TO	FRONT / REAR	LEFT / RIGHT
	KAWASAKI M ZX 6R 600 NINJA (Racing Applications)	600		1998	2001	F	
	M ZX-7 750 R NINJA (Racing Applications)	750		1996	2003	F	
	M ZX-9R 900 R NINJA (Racing Applications)	900		1996	1997	F	
	M ZX-9R 900 R NINJA (Racing Applications)	900		1998	1999	F	
	M ZX-9R 900 R NINJA (Racing Applications)	900		2000	2001	F	

		CC	KW	FROM	TO	FRONT / REAR	LEFT / RIGHT
	SUZUKI M ZX 12 1200 R (Racing Applications)	1200		2000	2003	F	
	M GSX-R 750 W (Racing Applications)	750		1994	1999	F	
	M GSX-R 1000 (Racing Applications)	1000		2001	2002	F	
	M GSX-R 1100 W (Racing Applications)	1100		1991	1996	F	
	M GSX-R 1300 HAYABUSA (Racing Applications)	1300		1999	2007	F	

M = MOTORCYCLE
S = SCOOTER
A = ATV
Sn = SNOWMOBILE

FDB2145

92.0 x 49.0 x 7.9 mm

MATERIAL AVAILABILITY

AG	EF	P	PRP	ST	SM	SG	ZR	XRAC	ZRAC	CP1	CPRO
				✓				⚠			

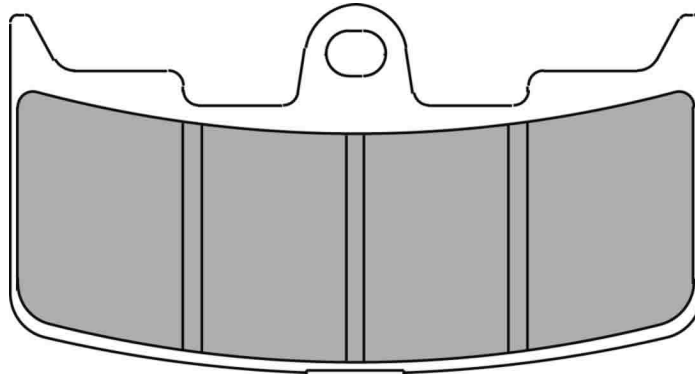

CROSS REFERENCE

BRAKING	895
BREMBO	07GR68
CL BRAKES	1139
EBC	FA345
GALFER	FD402
LUCAS/TRW	MCB747
NEWFREN	FD0344
SBS	795
VESRAH	VD-993



		CC	KW	FROM TO		FRONT	LEFT
				REAR	RIGHT		
BUELL	M Firebolt XB9R	984		2002	2007	F	
	M XB9S Lightning	984		2003	2004	F	
	M XB9SX Lightning CityX	984		2005	2009	F	
	M XB9 SX Lightning	984		2008	2010	F	
	M XB12 R Firebolt	1200		2004	2008	F	
	M XB12 STT Lightning	1200			2008	F	



		CC	KW	FROM TO		FRONT	LEFT
				REAR	RIGHT		
	M XB12 S Lightning	1200		2004	2008	F	
	M XB12 SCG Lightning	1200		2006	2008	F	
	M XB12 Ss Lightning Long	1200		2006	2008	F	
	M XB12 X Ulysses	1200		2006	2010	F	
	M XB12 XT Ulysses	1200		2008	2010	F	

FDB2146

79.0 x 47.0 x 7.6 mm

MATERIAL AVAILABILITY

AG	EF	P	PRP	ST	SM	SG	ZR	XRAC	ZRAC	CP1	CPRO
		✓									

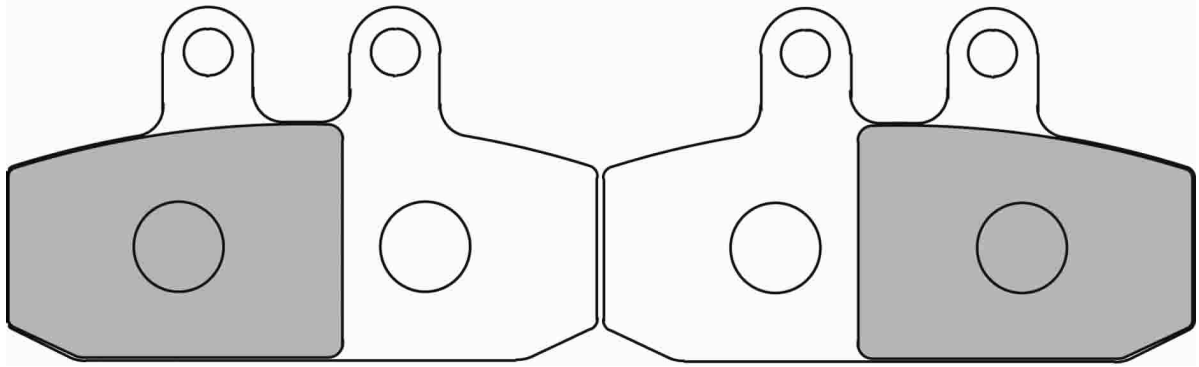

CROSS REFERENCE

BREMBO	07057
BREMBO	7057
EBC	FA256
LUCAS/TRW	MCB749
NEWFREN	FD0335
SBS	793
VESRAH	VD-9018



		CC	KW	FROM	TO	FRONT REAR	LEFT RIGHT
APRILIA	S ATLANTIC (ARECIFE) 500	500		2001		F	right

M = MOTORCYCLE
S = SCOOTER
A = ATV
Sn = SNOWMOBILE



FDB2147

94.6 x 42.1 x 7.2 mm / 77.1 x 42.1 x 7.2 mm

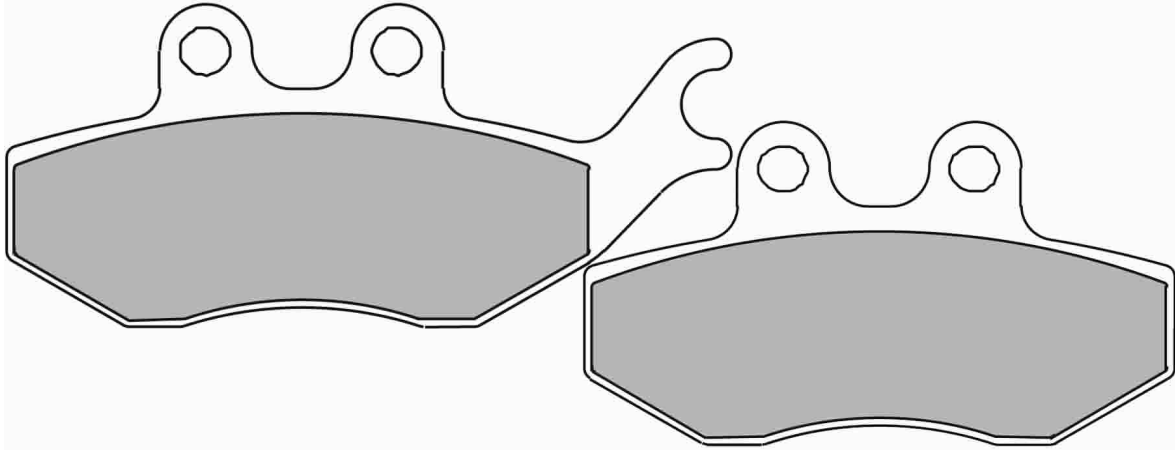
MATERIAL AVAILABILITY											
AG	EF	P	PRP	ST	SM	SG	ZR	XRAC	ZRAC	CP1	CPRO
✓											



CROSS REFERENCE	
BREMBO	07054
BREMBO	7054
BRENTA	3043
BRENTA	4043
EBC	FA374
LUCAS/TRW	MCB796
NEWFREN	FD0334
SBS	780
VESRAH	VD-9013

		CC	KW	FROM	TO	FRONT / REAR	LEFT / RIGHT
	ITALJET	M	JUPITER 125 / 150 / 250	125		2002 2003	R
		M	JUPITER 250	250		2002	R
	RIEJU	M	NKD 50	50		2007	F
		M	RS2 MATRIX 50 (AJP)	50		2002 2008	F

		CC	KW	FROM	TO	FRONT / REAR	LEFT / RIGHT
		M	RS2 50	50		2009	F
		M	NKD 125	125		2006 2007	F
		M	RS2 125 (AJP)	125		2006 2008	F

FDB2148

82.2 x 40.9 x 9.4 mm / 62.1 x 40.9 x 9.4 mm

December 2016: AG superseded by EF

MATERIAL AVAILABILITY											
AG	EF	P	PRP	ST	SM	SG	ZR	XRAC	ZRAC	CP1	CPR0
X	✓					✓					

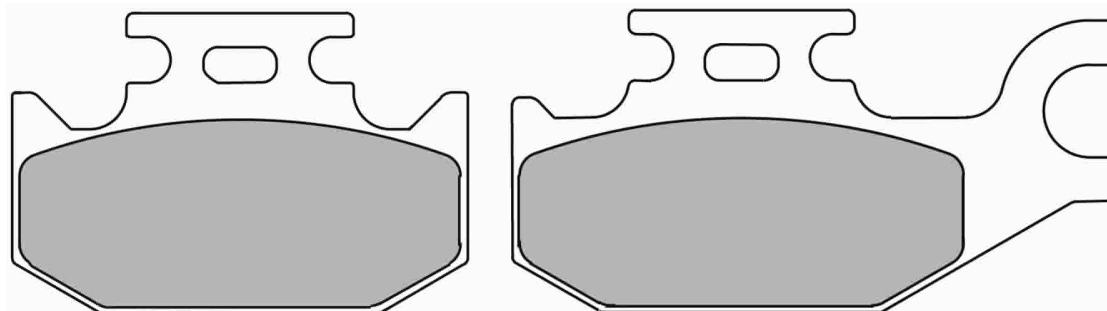

ALSO AVAILABLE		
SHAPE	TH. MM	NOTES
FDB2149		Coupled set
FDB2307	8.3	

CROSS REFERENCE	
BRAKING	862
BREMBO	07070
BREMBO	07GR49
BREMBO	7070
BRENTA	3108
BRENTA	3109
BRENTA	4108
BRENTA	4109
CL BRAKES	2923
EBC	FA307
EBC	FA413
GALFER	FD315
GOLD FREN	182
LUCAS/TRW	MCB724
NEWFREN	FD0301
SBS	196
SBS	754
VESRAH	VD-266

		CC	KW	FROM	TO	FRONT REAR	LEFT RIGHT
	BENELLI	M Caffe Nero 250	250	2008	2011	R	
	BOMBARDIER ATV	A OUTLANDER 330 HO	330	2004	2005	F	left
	A	OUTLANDER 330 HO	330	2004	2005	R	
	A	Outlander 400 (STD/MAX HO)	400	2003	2006	F	left
	A	Outlander 400 (STD/MAX HO)	400	2003	2006	R	
	A	QUEST 500 (2x4/4x4)	500	2002	2004	F	left
	A	TRAXTER 500 (4x4/XL/Autoshift)	500	2001	2005	F	left
	A	DS 650 (BAJA/X)	650	2000	2006	F	left
	A	DS 650 (BAJA/X)	650	2000	2006	R	
	A	Outlander 650 HO Efi (4x4/XT/Max)	650	2006		F	left
	A	Outlander 650 HO Efi (4x4/XT/Max)	650	2006		R	
	A	Quest 650 (2x4/4x4/XT/Max)	650	2002	2005	F	left
	A	TRAXTER 650 (Max/XT-4x4/Footshift)	650	2001	2005	F	left
	A	Outlander 800	800	2006		F	left
	A	Outlander 800	800	2006		R	
	A	TRAXTER 1000 XL	1000	2004		F	left
	CAN AM ATV	A Rally 200	200	2007		R	
	A	Outlander 400 (STD/XT/EFI 4x4)	400	2007	2010	F	left
	A	Outlander 400 (STD/XT/EFI 4x4)	400	2007	2010	R	
	A	Outlander Max 400 (STD/XT 4x4)	400	2007	2010	F	left
	A	Outlander Max 400 (STD/XT 4x4)	400	2007	2010	R	
	A	Outlander 500 (STD/XT 4x4)	500	2007	2012	F	left

		CC	KW	FROM	TO	FRONT REAR	LEFT RIGHT
	A	Outlander 500 (STD/XT 4x4)	500	2007	2012	R	
	A	Outlander Max 500 (STD/XT 4x4)	500	2007	2012	F	left
	A	Outlander Max 500 (STD/XT 4x4)	500	2007	2012	R	
	A	Renegade 500 (4x4/EFI)	500	2008	2011	F	left
	A	Renegade 500 (4x4/EFI)	500	2008	2011	R	
	A	DS 650 X	650	2007		F	left
	A	DS 650 X	650	2007		R	
	A	Outlander 650 (STD/XT 4x4)	650	2007	2012	F	left
	A	Outlander 650 (STD/XT 4x4)	650	2007	2012	R	
	A	Outlander Max 650 (STD/XT 4x4)	650	2007	2012	F	left
	A	Outlander Max 650 (STD/XT 4x4)	650	2007	2012	R	
	A	Outlander 800 (STD/XT 4x4)	800	2007	2011	F	left
	A	Outlander 800 (STD/XT 4x4)	800	2007	2011	R	
	A	Outlander Max 800 (Ltd/STD/XT 4x4)	800	2007	2011	F	left
	A	Outlander Max 800 (EFI/XT)	800	2007	2011	R	
	A	Outlander 800 R (EFI/XT)	800	2009	2011	F	left
	A	Outlander 800 R (EFI/XT)	800	2009	2011	R	
	A	Outlander Max 800 R (EFI/XT)	800	2009	2011	F	left
	A	Outlander Max 800 R (EFI/XT)	800	2009	2011	R	
	A	Renegade 800 (4x4/EFI) (STD/X)	800	2008	2011	F	left
	A	Renegade 800 (4x4/EFI) (STD/X)	800	2008	2011	R	
	A	Renegade 800 R (EFI/X)	800	2009	2011	F	left

M = MOTORCYCLE
S = SCOOTER
A = ATV
Sn = SNOWMOBILE

		CC	KW	FROM	TO	FRONT / REAR	LEFT / RIGHT
	A Renegade 800 R (EFI/X)	800		2009	2011	R	
	A Commander Max 1000 DPS/XT	1000		2014		R	left
	A Maverick Max 1000 STD/XRS/DPS	1000		2014	2015	R	left
CANNONDALE ATV	A CANNIBAL 400 BLACK / SILVER	400		2002	2003	F	left
	A CANNIBAL 400 BLACK / SILVER	400		2002	2003	R	
	A FX 400	400		2001		F	left
	A FX 400	400		2001		R	
	A BLAZE 440	440		2002	2003	F	left
	A BLAZE 440	440		2002	2003	R	
	A GLAMIS 440	440		2003		F	left
	A GLAMIS 440	440		2003		R	
	A MOTO 440	440		2002	2003	F	left
	A MOTO 440	440		2002	2003	R	
	A SPEED 440	440		2002	2003	F	left
	A SPEED 440	440		2002	2003	R	
JOHN DEERE ATV	A Buck 500 EX	500		2004	2008	F	left

		CC	KW	FROM	TO	FRONT / REAR	LEFT / RIGHT
	A Trail Buck 500 EX	500		2004	2005	F	left
	A Buck 650 EXT	650		2004	2008	F	left
	A Trail Buck 650 EXT	650		2004	2005	F	left
SUZUKI	S SIXTEEN 125 UH	125		2008		R	
	S UH 125 BURGMAN	125		2007	2013	R	
	S UH 125 BURGMAN ABS	125		2014		R	
	S SIXTEEN 150 UH	150		2008		R	
	S UH 150 BURGMAN	150	11	2007	2013	R	
	S UH 200 BURGMAN	200		2007	2013	R	
	S UH 200 BURGMAN ABS	200		2014		R	
YAMAHA ATV	A YFM 400 FW KODIAK (All Models except AUTO)	400		2000	2006	R	
	A YFM 400 4x4 Grizzly	400		2007	2008	R	
	A YFM 450 KODIAK	450		2003	2006	R	
	A YFM 450 WOLVERINE (All models)	450		2006	2010	R	
	A YFM 450 Grizzly (All models)	450		2007	2010	R	

FDB2149

82.2 x 40.9 x 9.4 mm / 62.1 x 40.9 x 9.4 mm

See also FDB2235 for version with pin

MATERIAL AVAILABILITY											
AG	EF	P	PRP	ST	SM	SG	ZR	XRAC	ZRAC	CP1	CPRO
						✓					

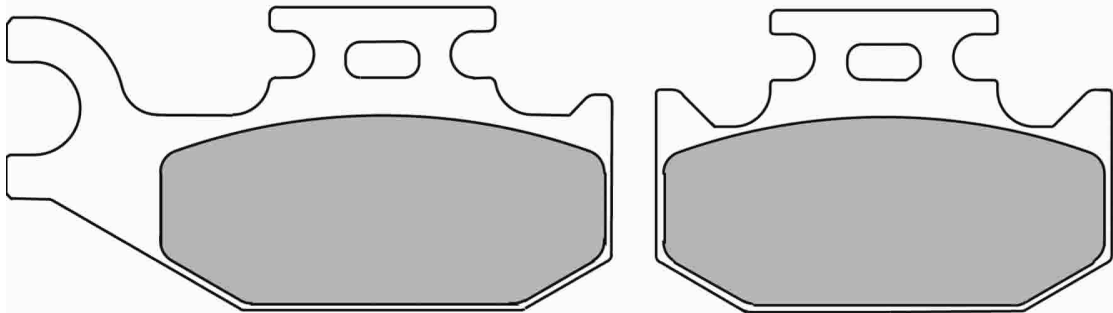

ALSO AVAILABLE		
SHAPE	TH. MM	NOTES
FDB2148		Coupled set
FDB2308	8.3	

CROSS REFERENCE	
BREMBO	07GR50
BRENTA	3110
BRENTA	3111
BRENTA	4110
BRENTA	4111
CL BRAKES	1102
EBC	FA317
EBC	FA414
LUCAS/TRW	MCB723
NEWFREN	FD0318
SBS	767
VESRAH	VD-276
VESRAH	VD-979

		CC	KW	FROM	TO	FRONT / REAR	LEFT / RIGHT
BOMBARDIER ATV	A	OUTLANDER 330 HO	330	2004	2005	F	right
	A	Outlander 400 (STD/MAX HO)	400	2003	2006	F	right
	A	QUEST 500 (2x4/4x4)	500	2002	2004	R	right
	A	QUEST 500 (2x4/4x4)	500	2002	2004	F	right
	A	TRAXTER 500 (4x4/XL/Autoshift)	500	2001	2005	R	right
	A	TRAXTER 500 (4x4/XL/Autoshift)	500	2001	2005	F	right
	A	DS 650 (BAJA/X)	650	2000	2006	F	right
	A	Outlander 650 HO Efi (4x4/XT/Max)	650	2006		F	right
	A	Quest 650 (2x4/4x4/XT/Max)	650	2002	2005	R	right
	A	Quest 650 (2x4/4x4/XT/Max)	650	2002	2005	F	right
	A	TRAXTER 650 (Max/XT-4x4/Footshift)	650	2001	2005	R	right
	A	TRAXTER 650 (Max/XT-4x4/Footshift)	650	2001	2005	F	right
	A	Outlander 800	800	2006		F	right
	A	TRAXTER 1000 XL	1000	2004		R	right
	A	TRAXTER 1000 XL	1000	2004		F	right
CAN AM ATV	A	Outlander 400 (STD/XT/EFI 4x4)	400	2007	2010	F	right
	A	Outlander Max 400 (STD/XT 4x4)	400	2007	2010	F	right
	A	Outlander 500 (STD/XT 4x4)	500	2007	2012	F	right
	A	Outlander Max 500 (STD/XT 4x4)	500	2007	2012	F	right
	A	Renegade 500 (4x4/EFI)	500	2008	2011	F	right
	A	DS 650 X	650	2007		F	right
	A	Outlander 650 (STD/XT 4x4)	650	2007	2012	F	right
	A	Outlander Max 650 (STD/XT 4x4)	650	2007	2012	F	right
	A	Outlander 800 (STD/XT 4x4)	800	2007	2011	F	right

		CC	KW	FROM	TO	FRONT / REAR	LEFT / RIGHT
	A	Outlander Max 800 (Ltd/STD/XT 4x4)	800	2007	2011	F	right
	A	Outlander 800 R (EFI/XT)	800	2009	2011	F	right
	A	Outlander Max 800 R (EFI/XT)	800	2009	2011	F	right
	A	Renegade 800 (4x4/EFI) (STD/X)	800	2008	2011	F	right
	A	Renegade 800 R (EFI/X)	800	2009	2011	F	right
	A	Commander Max 1000 DPS/XT	1000	2014		R	right
	A	Maverick Max 1000 STD/XRS/DPS	1000	2014	2015	R	right
CANNONDALE ATV	A	CANNIBAL 400 BLACK / SILVER	400	2002	2003	F	right
	A	FX 400	400	2001		F	right
	A	BLAZE 440	440	2002	2003	F	right
	A	GLAMIS 440	440	2003		F	right
	A	MOTO 440	440	2002	2003	F	right
	A	SPEED 440	440	2002	2003	F	right
JOHN DEERE ATV	A	Buck 500 EX	500	2004	2008	R	right
	A	Buck 500 EX	500	2004	2008	F	right
	A	Trail Buck 500 EX	500	2004	2005	R	right
	A	Trail Buck 500 EX	500	2004	2005	F	right
	A	Buck 650 EXT	650	2004	2008	R	right
	A	Buck 650 EXT	650	2004	2008	F	right
	A	Trail Buck 650 EXT	650	2004	2005	R	right
	A	Trail Buck 650 EXT	650	2004	2005	F	right
YAMAHA ATV	A	YXR 450 RHINO - side by side	450	2004	2009	R	right
	A	YXR 660 RHINO - side by side	660	2004	2007	R	right

FDB2150

63.6 x 60.5 x 8.8 mm

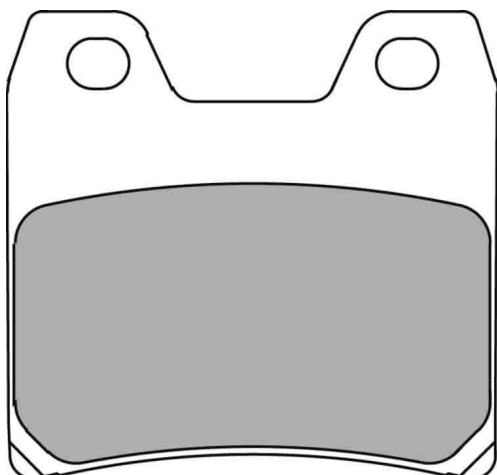

MATERIAL AVAILABILITY

AG	EF	P	PRP	ST	SM	SG	ZR	XRAC	ZRAC	CP1	CPRO
				✓							

CROSS REFERENCE

BREMBO	07YA40
CL BRAKES	1066
EBC	FA348
GALFER	FD329
LUCAS/TRW	MCB725
NEWFREN	FD0341
SBS	770
VESRAH	VD-268

M = MOTORCYCLE
S = SCOOTER
A = ATV
Sn = SNOWMOBILE

		CC	KW	FROM	TO	FRONT / REAR	LEFT / RIGHT
YAMAHA	M FZS 1000 FAZER	1000		2001	2005	R	

		CC	KW	FROM	TO	FRONT / REAR	LEFT / RIGHT
M	XJR 1300	1300		2001		R	

FDB2153

89.9 x 42.2 x 10.1 mm

Set=4 Pads

MATERIAL AVAILABILITY											
AG	EF	P	PRP	ST	SM	SG	ZR	XRAC	ZRAC	CP1	CPRO
		✓									

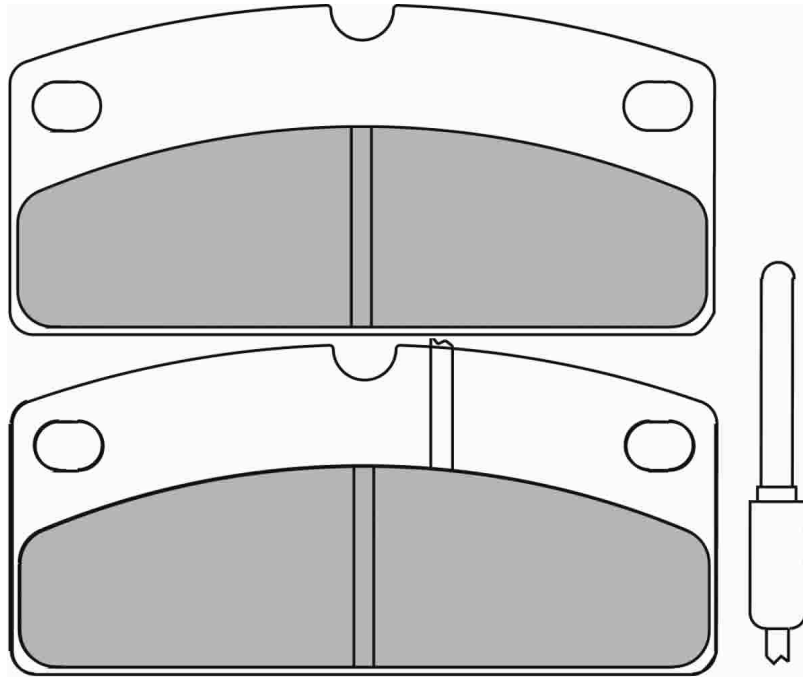

CROSS REFERENCE	
NEWFREN	FD0343

		CC	KW	FROM	TO	FRONT / REAR	LEFT / RIGHT
LIGIER	M NOVA	500		2001		F	
PIAGGIO	M M 500 Minicar	500		2006	2008	F	

		CC	KW	FROM	TO	FRONT / REAR	LEFT / RIGHT
M	PK 500 Motocarro	500		2006	2008	F	

FDB2154

89.9 x 42.2 x 9.6 mm

Set=4 Pads

MATERIAL AVAILABILITY											
AG	EF	P	PRP	ST	SM	SG	ZR	XRAC	ZRAC	CP1	CPRO
		✓									

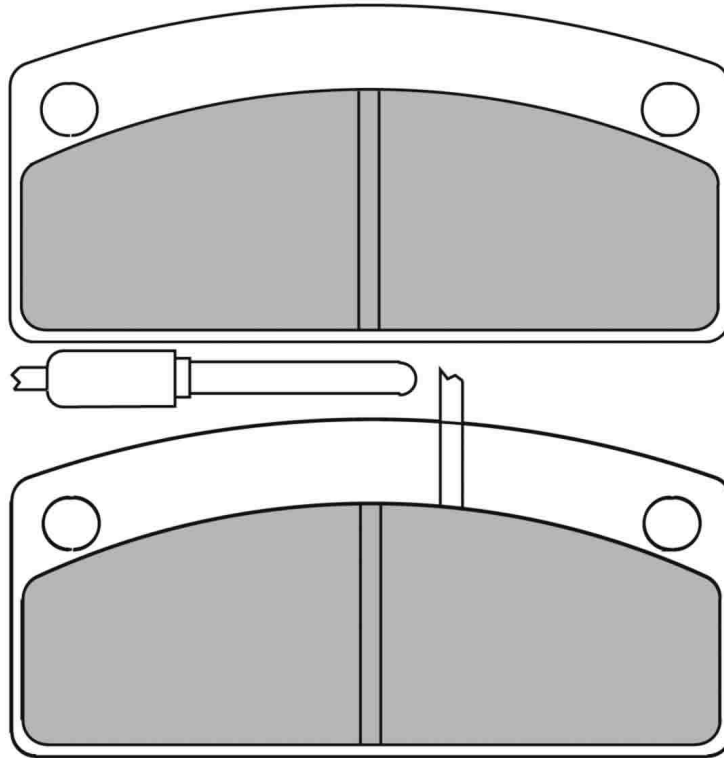

CROSS REFERENCE	
BRENTA	3038
BRENTA	4038
GALFER	FD221
NEWFREN	FD0336

		CC	KW	FROM	TO	FRONT / REAR	LEFT / RIGHT
	GREKAV						
	M EIKE 505	50				F	

M = MOTORCYCLE
S = SCOOTER
A = ATV
Sn = SNOWMOBILE

FDB2156

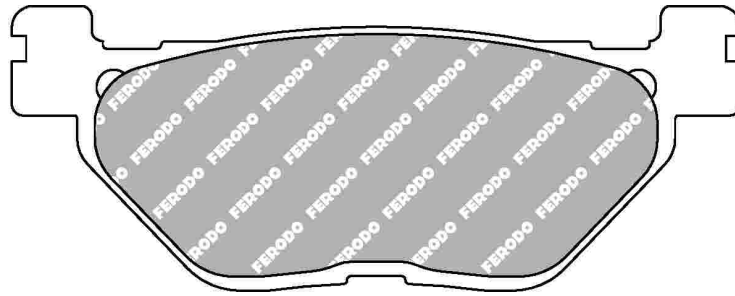

100.3 x 39.3 x 9.5 mm

MATERIAL AVAILABILITY											
AG	EF	P	PRP	ST	SM	SG	ZR	XRAC	ZRAC	CP1	CPRO
	✓	✓		✓							



ALSO AVAILABLE		
SHAPE	TH. MM	NOTES
FDB2126	12.0	

CROSS REFERENCE	
BRAKING	903
BREMBO	07YA39
BRENTA	3139
BRENTA	4139
CL BRAKES	1084
EBC	FA319/2
GALFER	FD295
GOLD FREN	165
LUCAS/TRW	MCB731
NEWFREN	FD0345
SBS	769
VESRAH	VD-269/2

		CC	KW	FROM	TO	FRONT / REAR	LEFT / RIGHT
	HYOSUNG	M					
		GV 650 AQUILA (Carb)	650		2004	2006	R
		M					
		GV 1000	1000		2004		R
	YAMAHA	M					
		TDM 900	900		2002		R
		SCR 950 ABS	950		2017		R
		XV 950 (NO ABS&ABS)	950		2014		R
		XV 950 R ABS	950		2014		R
		XV950 Racer	950		2017		R
		XVS 950 A Midnight Star	950		2009	2013	R
		XVS 950 (Non ABS/Standard Rear Shocks)	950		2014		R
		XVS 950 (1XC1/ABS/Standard Rear Shocks)	950		2014		R
		XVS 950 R (2DE/Remote Reservoir Rear Shocks)	950		2014		R
		XT 1200 ZE Super Tenere' Raid ed.	1199	82	2018		R
		XT 1200 ZE ABS (Supertenerere)	1200		2014		R
	XT 1200 ZE ABS Worldcrosser (Supertenerere)	1200		2016		R	
	XT 1200 Z Super Tenere' (DP01) ABS	1200	81	2010	2013	R	

		CC	KW	FROM	TO	FRONT / REAR	LEFT / RIGHT
	M	XT 1200 Z Super Tenere' ABS	1200	82	2014		R
	M	XT 1200 Z Super Tenere' ABS Worldcrosser	1200		2016		R
	M	FJR 1300	1300		2001	2002	R
	M	FJR 1300/FJR 1300 A	1300		2003	2005	R
	M	FJR 1300A (ABS - 4 pad Front caliper)	1300		2006		R
	M	FJR 1300AS (ABS - Electric gearshift)	1300		2006		R
	M	FJR 1300AE (ABS - Electronic suspension adj)	1300		2015		R
	M	XVS 1300 A Midnight Star (VP26)	1300		2007		R
	M	XVS 1300 Custom (VP36)	1300		2014		R
	M	XVS 1300 A CFD	1300		2014		R
	M	V-MAX	1680		2009		R
	M	XV 1700 ROYAL STAR WARRIOR	1700		2002		R
	M	XV 1900 A Midnight Star	1900		2006	2012	R
	M	XV 1900 A Midnight Star	1900		2013		R
	M	XV 1900 A CFD	1900		2014		R

FDB2157

62.2 x 31.7 x 6.5 mm

MATERIAL AVAILABILITY											
AG	EF	P	PRP	ST	SM	SG	ZR	XRAC	ZRAC	CP1	CPRO
						✓					

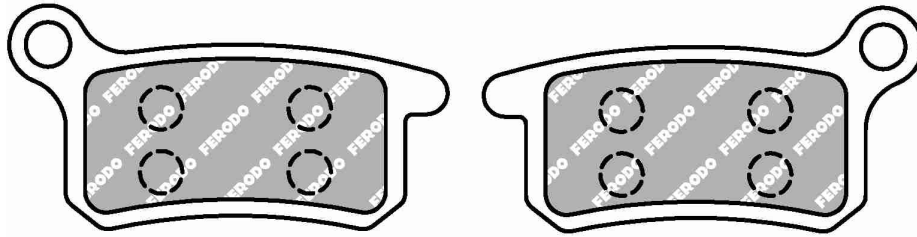

CROSS REFERENCE	
BRAKING	873
BREMBO	07GR69
BRENTA	4160
CL BRAKES	1078
EBC	FA357
GALFER	FD265
LUCAS/TRW	MCB740
NEWFREN	FD0354
SBS	783

		CC	KW	FROM	TO	FRONT / REAR	LEFT / RIGHT
	HUSQVARNA	M	CR 65	65	2010 2013	F	
		M	TC65	65	2017	F	
		M	TC65	65	2017	R	
KTM	M	SX 65	65	2002 2003	F		
	M	SX 65	65	2004 2009	F		

		CC	KW	FROM	TO	FRONT / REAR	LEFT / RIGHT
	M	SX 65	65	2010		F	
	M	SX 65	65	2010		R	
	M	SX 85	85	2003 2010		F	
	M	SX 85	85	2003 2010		R	
	M	SX 85 (17"/14")	85	2011		F	

M = MOTORCYCLE
S = SCOOTER
A = ATV
Sn = SNOWMOBILE

FDB2158

69.8 x 49.6 x 7.1 mm

MATERIAL AVAILABILITY

AG	EF	P	PRP	ST	SM	SG	ZR	XRAC	ZRAC	CP1	CPRO
				✓							

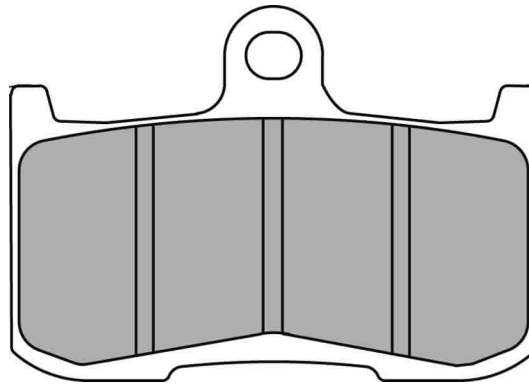

**Pinze / Calipers****Nissin**

Nissin 4Pot Radial Mount/cast two piece

CROSS REFERENCE

BRAKING	906
BREMBO	07KA23
BRENTA	3120
BRENTA	4120
CL BRAKES	1083
EBC	FA347
GALFER	FD331
GOLD FREN	207
LUCAS/TRW	MCB737
NEWFREN	FD0351
SBS	782
VESRAH	VD-443

		CC	KW	FROM	TO	FRONT REAR	LEFT RIGHT	
	INDIAN	M Chief Classic	1811	55	2014	2016	F	
		M Chief Vintage	1811	55	2014		F	
		M Chief Dark Horse	1811	55	2015		F	
		M Chief Vintage	1811	62	2018		F	
		M Chieftain	1811	55	2014	2016	F	
		M Chieftain	1811	62	2018		F	
		M Chieftain Classic	1811	62	2018		F	
		M Chieftain Dark Horse	1811	62	2018		F	
		M Chieftain Limited	1811	62	2018		F	
		M Roadmaster	1811	55	2015	2016	F	
		M Roadmaster	1811	62	2018		F	
		M Springfield Dark Horse	1811		2018		F	
		KAWASAKI	M Z 800 (ZR800A)	800	72	2013		F
			M Z 800 ABS (ZR800B)	800	83	2013		F
			M Z 800 (ZR800A)	800	78	2013		F
		M Z 800 (ZR800A)	800	83	2013		F	
		M Z 800 Sugomi Ed.	800		2016		F	
		M Z 800 e ABS (ZR800D)	800	70	2013		F	
		M Z 900	900		2017		F	
		M ZX-9R 900 R NINJA F1-F2	900		2002	2004	F	
		M Z 1000 (ZR 1000 A1)	1000		2003	2006	F	
		SUZUKI	M GSX-S 750 ABS	750		2016		F
		M GSX 1300 B-KING / Hyaku	1300		2007		F	
		M B-KING	1340		2010		F	
	TRIUMPH	M DAYTONA 675 / Special Edition / Triple	675		2006	2008	F	
		M STREET TRIPLE 675 R	675		2009	2012	F	
		M STREET TRIPLE 675 R	675		2013		F	
		M STREET TRIPLE 675 Rx	675		2015		F	
		M SPEED TRIPLE 1050	1050		2004	2007	F	
		M TIGER SE ABS 1050	1050		2008		F	
	M TIGER SPORT	1050		2013		F		

		CC	KW	FROM	TO	FRONT REAR	LEFT RIGHT
	VICTORY	M Cross Country			2010	2014	F
		M Cross Country Tour			2012	2015	F
		M Cross Country 8-Ball			2015		F
		M Cross Roads			2010	2012	F
		M Cross Roads Classic (Spoke Wheel)			2013	2014	F
		M Cross Roads 8 - Ball (Cast Wheel)			2014		F
		M Cross Touring			2013	2014	F
		M Gunner			2015		F
		M Hammer			2008	2011	F
		M Hammer S			2008	2015	F
		M Hammer 8 Ball			2010	2015	F
		M Hard Ball			2012	2013	F
		M Highball (Cast & Spoke Wheel)			2012		F
		M Jackpot			2010	2014	F
		M Judge			2013		F
		M King Pin			2008	2012	F
		M Kingpin Tour			2008	2009	F
		M Kingpin 8-Ball			2008	2011	F
		M King Pin Low			2009	2009	F
		M Magnum			2015		F
		M Magnum X-1			2015		F
		M Cory Ness Jackpot			2008	2010	F
		M Zach Ness Vegas			2008	2012	F
	M Cory Ness Cross Country			2011	2012	F	
	M Broadwalk			2013	2015	F	
	M Vegas 8-Ball			2008	2015	F	
	M Vegas			2008		F	
	M Vegas Low			2008	2009	F	
	M Vegas Jackpot			2008	2009	F	
	YAMAHA	M TZ 250	250		2002	2008	F

4238

FERODO

RACING

Updated on November 2020

M = MOTORCYCLE
S = SCOOTER
A = ATV
Sn = SNOWMOBILE

FDB2162

66.9 x 36.0 x 9.4 mm

MATERIAL AVAILABILITY											
AG	EF	P	PRP	ST	SM	SG	ZR	XRAC	ZRAC	CP1	CPO
	✓	✓				✓					

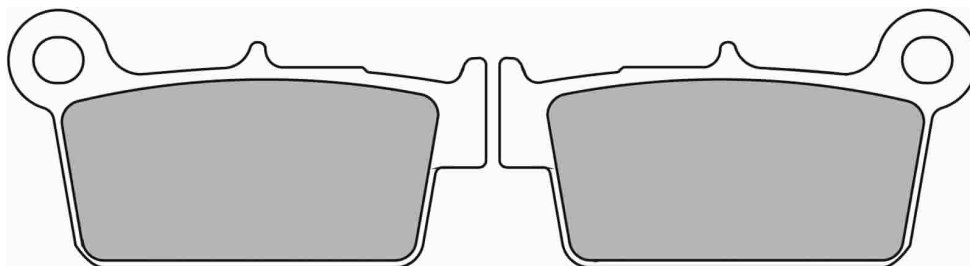



Pinze / Calipers





Magura

4-Piston Radial Mount

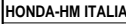
CROSS REFERENCE

BRAKING	890
BREMBO	07YA41
BRENTA	3101
BRENTA	4101
CL BRAKES	1103
EBC	FA367
GALFER	FD286
GALFER	FD456
GOLD FREN	187
LUCAS/TRW	MCB739
NEWFREN	FD0349
SBS	790
VESRAH	VD-271

		CC	KW	FROM	TO	FRONT REAR	LEFT RIGHT
	M RXV 450 / Rally / Merriman Replica	450		2005		R	
	M SXV 450	450		2005	2007	R	
	M SXV VDB Replica	450		2007	2007	R	
	M RXV 550	550		2005		R	
	M SXV 550	550		2005		R	
	M SXV VDB Replica	550		2007	2007	R	
	M RR 50 Enduro	50		2008	2012	R	
	M RR Motard 50 Track (Cast Wheels)	50		2008	2012	R	
	M RR 50 Enduro Racing	50		2009	2011	R	
	M RR 50 Enduro Standard	50		2009	2012	R	
	M RR 50 Motard Standard	50		2009	2012	R	
	M RR 50 Motard Skull	50		2011		R	
	M RR 50 Enduro Factory	50		2012		R	
	M RE 125 4T Enduro	125		2009	2010	R	
	M RE 125 4T Enduro	125		2010	2012	R	
	M RR 125 4T Motard (A/C - Spoke Wheel)	125		2008	2012	R	
	M RR 125 4T Enduro (A/C)	125		2009	2011	R	
	M RR 125 4T Enduro (L/C)	125		2011		R	
	M RR 125 4T Motard (L/C - Cast Wheel)	125		2011	2012	R	
	M RR Enduro 125 2T	125		2018		R	
	M Urban 125 Special	125		2009	2012	R	
	M Urban 200 Special	200		2009	2012	R	
	M RR 250 4T Enduro	250		2005	2007	R	
	M RR 250 2T Enduro	250		2015		R	
	M RR 300 2T Enduro	300		2015		R	
	M XTRAINER 300	300		2015		R	
	M RR 350 4T Enduro	350		2011		R	
	M RR 350 EFI 4T Enduro	350		2015		R	
	M RR 390 4T Enduro	390		2015		R	
	M RR 400 4T Enduro	400		2005		R	
	M RR 430 4T Enduro	430		2015		R	
	M RR 450 4T Enduro	450		2005	2013	R	
	M RR 450 4T Cross Country	450		2012		R	
M RR 480 4T Enduro	480		2015		R		
M RR 498 4T Enduro	500		2012		R		
M RR 520 4T Enduro	520		2010	2011	R		
M RR 525 4T Enduro	525		2005	2009	R		
	M CRE 50 SIX Comp.	50		2007	2012	R	
	M CRE 50 Six Racing	50		2011		R	
	M CRM 50 Derapage Comp.	50		2007	2012	R	
	M CRE 125 SIX Comp.	125		2010	2011	R	
	M CRE 125 4T Six Racing	125		2011		R	

		CC	KW	FROM	TO	FRONT REAR	LEFT RIGHT	
	M CRM 125 2T Derapage Comp.	125		2011	2012	R		
	M CRM 125 4T Derapage Comp.	125		2011	2012	R		
	M KX 250 F	250		2004		R		
	M KLX 450 R	450		2007		R		
	M KX 450	450		2019		R		
	M KX 450 F	450		2006		R		
		M MTR 50 Competizione (Spoke Wheel)	50		2011		R	
		M Marathon Pro 125 Competizione (Spoke Wheel)	125		2011		R	
		M Enduro 2.5i (4T) Inc. SE Models	250		2008	2011	R	
		M SM 2.5i Supermotard (4T)	250		2008		R	
M SX 2.5i F Moto Cross		250		2010		R		
M Enduro SE 3.0i (4T)		300		2010	2011	R		
M Enduro 4.5i (4T) Inc SE Models		450		2004	2011	R		
M SE 450 i R (Nissin Rear Caliper)		450		2012	2013	R		
M SM 4.5i F (Supermotard)		450		2004	2010	R		
M SM 4.5i F (Black Panther)		450		2008	2012	R		
M Enduro 5.1i F Inc SE Models		510		2007	2011	R		
M SE 510 i R (Nissin Rear Caliper)		510		2012	2013	R		
	M SM 5.1i F Supermotard	510		2007		R		
	M SM 5.1i F Black Panther	510		2008	2012	R		
	M DR 125 SM	125		2008		R		
	M RM 125	125		2009		R		
	M RM 125 E	125		2009		R		
	M SM 125	125		2010		R		
	M RM 250	250		2009		R		
	M RM-Z 250	250		2004	2018	R		
	M RM-Z 250 / E	250		2009		R		
	M RM-Z 250	250		2019		R		
	M RM-Z 450	450		2005	2007	R		
	M RM-Z 450 / E	450		2008		R		
	M RMX 450 E	450		2009		R		
	M SM 450X	450		2009		R		
	M 80 Junior	80		2005	2007	R		
	M 85 Junior	85		2005	2007	R		
	M MX 85 (Big Wheel)	85		2005		R		
	M MX 85 JR (Small Wheel)	85		2005		R		
	M 100 Junior	100		2005	2007	R		
	M Enduro EN 125 (2T) - USA VERSION	125		2005	2008	R		
	M MX 125 (2T)	125		2005		R		
	M SMR 125 (2T)	125		2005	2014	R		
	M SMR 125 (2T)	125		2015		R		
	M SMX 125 (2T)	125		2015		R		
	M SMX 125 (2T)	125		2015		R		

M = MOTORCYCLE
S = SCOOTER
A = ATV
Sn = SNOWMOBILE

FERODO
RACING
Updated on November 2020

4239

		CC	KW	FROM	TO	FRONT / REAR	LEFT / RIGHT
	M EN 144 (2T)	144		2008		R	
	M MX 144 (2T)	144		2008		R	
	M Enduro EN 250 (2T)	250		2005		R	
	M EN 250 Fi (4T) Enduro	250		2005		R	
	M EN 250 Fi ES	250		2015		R	
	M MX 250 (4T) Cross	250		2005	2012	R	
	M MX 250 (2T)	250		2005		R	
	M MX 250 Fi (4T)	250		2010		R	
	M SMM 250 Fi (4T)	250		2010		R	
	M SMR 250 (2T)	250		2005	2014	R	
	M SMR 250 Fi (4T)	250		2010		R	
	M SMR 250 (2T)	250		2015		R	
	M SMX 250 Fi (4T)	250		2012		R	
	M SMX 250 (2T)	250		2015		R	
	M Enduro EN 300 (2T)	300		2005		R	
	M EN 300 Fi (4T)	300		2017		R	
	M MX 300 (2T)	300		2005		R	
	M MX 300 Fi (4T)	300		2017		R	
	M SMR 300 (2T)	300		2005	2014	R	
	M SMR 300 (2T)	300		2015		R	
	M SMX 300 (2T)	300		2015		R	
	M EN 450 Fi (4T)	450		2005		R	
	M EN 450 Fi ES	450		2015		R	
	M FLAT TRACK 450 Fi	450		2016		R	
	M MX 450 Fi (4T)	450		2005		R	
	M SMR 450 FES	450		2005	2009	R	

		CC	KW	FROM	TO	FRONT / REAR	LEFT / RIGHT
	M SMR 450 Fi (4T)	450		2010		R	
	M SMX 450 Fi (4T)	450		2005		R	
	M EN 530 Fi (4T)	530		2005		R	
	M MX 530 F	530		2005		R	
	M MX 530 Fi (4T)	530		2016		R	
	M SMR 530 F ES	530		2005	2009	R	
	M SMR 530 Fi (4T)	530		2010		R	
	M SMX 530 Fi (T)	530		2005		R	
	M SMX 660 F	660		2005	2010	R	
YAMAHA	M YZ 125	125		2003	2007	R	
	M YZ 125	125		2008		R	
	M WR 250 F (4T)	250		2003	2016	R	
	M WR 250 X (Supermotard) (32D2/4)	250		2008	2010	R	
	M WR 250 R (32D1/3)	250		2008	2010	R	
	M WR 250 F	250		2017		R	
	M YZ 250 (2T)	250		2003	2007	R	
	M YZ 250 F (4T)	250		2003	2006	R	
	M YZ 250 F (4T)	250		2007		R	
	M YZ 250 (2T)	250		2008		R	
	M YZ 250 F 60th Anniv.	250		2016		R	
	M WR 450 F	450		2003		R	
	M WR 450 F	450		2019		R	
	M YZ 450 F	450		2003	2007	R	
	M YZ 450 F	450		2008		R	
	M YZ 450 F 60th Anniv.	450		2016		R	
	M YZ 450 F	450		2020		R	

FDB2163

69.9 x 46.1 x 13.1 mm

MATERIAL AVAILABILITY

AG	EF	P	PRP	ST	SM	SG	ZR	XRAC	ZRAC	CP1	CPRO
				✓							

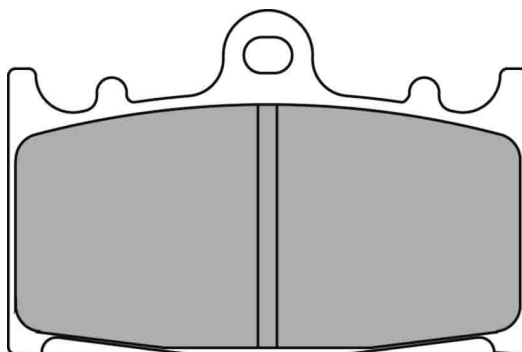

CROSS REFERENCE

BREMBO	07SU30
CL BRAKES	1145
EBC	FA366
LUCAS/TRW	MCB741
NEWFREN	FD0371
SBS	789
VESRAH	VD-344/4

		CC	KW	FROM	TO	FRONT / REAR	LEFT / RIGHT
	SUZUKI M INTRUDER C1500	1500		2005	2009	R	

		CC	KW	FROM	TO	FRONT / REAR	LEFT / RIGHT
	M VL 1500 K2	1500		2002	2003	R	

FDB2164

39.0 x 49.9 x 7.9 mm

Set=4 Pads

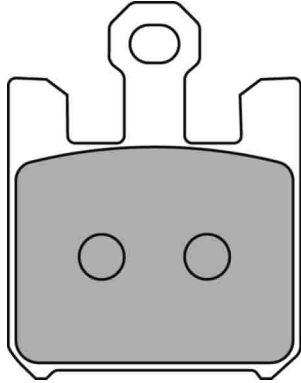

MATERIAL AVAILABILITY											
AG	EF	P	PRP	ST	SM	SG	ZR	XRAC	ZRAC	CP1	CPRO
				✓				✓	✓		

ALSO AVAILABLE		
SHAPE	TH. MM	NOTES
FDB2203	9.3	Racing Applications

Pinze / Calipers

Magura

4-Piston Radial Mount

CROSS REFERENCE	
BRAKING	893
BREMBO	07SU26
BRENTA	4119
EBC	FA369/4HH
GALFER	FD290
GALFER	FD371
GOLD FREN	200
LUCAS/TRW	MCB742
NEWFREN	FD0352
SBS	788
VESRAH	VD-354

		CC	KW	FROM	TO	FRONT REAR	LEFT RIGHT
 KAWASAKI	M ZX 6RR (ZX 599 B1)	599		2003	2006	F	
	M ZX 6R (ZX 636 K1)	636		2003	2006	F	
	M ZX-10R 1000	1000	149	2004	2007	F	

		CC	KW	FROM	TO	FRONT REAR	LEFT RIGHT
 SUZUKI	M ZX-12R 1200	1200		2004		F	
	M GSX-R 1000	1000		2003	2003	F	

FDB2165

64.3 x 41.8 x 9.0 mm

MATERIAL AVAILABILITY

AG	EF	P	PRP	ST	SM	SG	ZR	XRAC	ZRAC	CP1	CPRO
	✓	✓				✓					

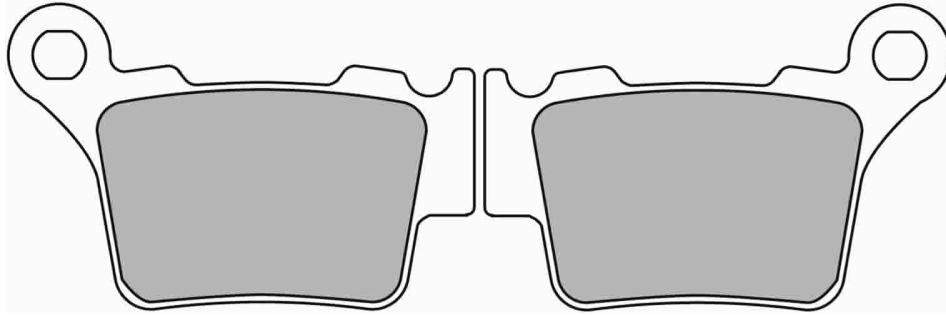
**CROSS REFERENCE**

BRAKING	891
BREMBO	07.8493.12
BREMBO	07BB27
BRENTA	3056
BRENTA	4056
CL BRAKES	1108
EBC	FA368
GALFER	FD291
GOLD FREN	191
LUCAS/TRW	MCB743
NEWFREN	FD0348
SBS	791
VESRAH	VD-997



		CC	KW	FROM	TO	FRONT REAR	LEFT RIGHT
BMW	M G450 X	450		2008		R	
HUSQVARNA	M CR 125	125		2005	2013	R	
	M TC 125 (2T)	125		2014		R	
	M TE 125 (2T)	125		2014		R	
	M TX 125	125		2018		R	
	M WR 125	125		2006	2013	R	
	M ENDURO WR 125	125		2010		R	
	M WRE 125	125		2000	2013	R	
	M CR 250	250		2005	2007	R	
	M FC 250 (4T)	250		2014		R	
	M FE 250 (4T)	250		2014		R	
	M TC 250	250		2005	2008	R	
	M TC 250 (4T)	250		2009	2013	R	
	M TC 250 R	250		2013		R	
	M TC 250 (2T)	250		2014		R	
	M TE 250 (4T)	250		2006	2013	R	
	M TE 250 Meo Replica (4T)	250		2011	2011	R	
	M TE 250 R (4T)	250		2013		R	
	M TE 250 (2T)	250		2014		R	
	M TE 300 (2T)	300		2014		R	
	M TE 310	310		2010	2013	R	
	M TE 310 R (4T)	310		2013		R	
	M FC 350 (4T)	350		2014		R	
	M FE 350 (4T)	350		2015		R	
	M SMR 449 (4T)	449		2011		R	
	M TC 449	449		2011	2013	R	
	M TE 449	449		2011	2013	R	
	M FC 450 (4T)	450		2014		R	
	M FE 450 (4T)	450		2014		R	
	M FS 450	450		2015		R	
	M SM 450 RR (Radial Caliper)	450		2006	2007	R	
	M SM 450 R Radial caliper	450		2007	2010	R	
	M SM 450 RR	450		2008	2010	R	
	M TC 450	450		2005	2010	R	
	M TE 450	450		2006	2008	R	
	M TE 450 (4T)	450		2009	2010	R	
	M FE 501 (4T)	501		2014		R	
	M SM 510 R (Radial caliper)	510		2006	2010	R	
	M TC 510	510		2005	2009	R	
	M TE 510	510		2006	2010	R	



		CC	KW	FROM	TO	FRONT REAR	LEFT RIGHT
	M SMR 511	511		2011	2013	R	
	M TE 511 (4T)	511		2011	2012	R	
	M SM 530 RR	530		2008	2010	R	
KTM	M 125 EXC (2T)	125		2004		R	
	M 125 EXC Six Days (2T)	125		2011		R	
	M SX 125	125		2003		R	
	M 125 XC-W (2T)	125		2018		R	
	M SX 150	150		2008		R	
	M 200 EXC (2T)	200		2004		R	
	M SX 200	200		2003		R	
	M 250 EXC (2T)	250		2004		R	
	M SX 250	250		2003		R	
	M 250 EXC-F (4T)	250		2007		R	
	M 250 EXC Six Days (2T)	250		2011		R	
	M 250 EXC-F Six Days (4T)	250		2011		R	
	M MX 250	250		2003		R	
	M SX 250 (2T)	250		2003		R	
	M SX-F 250 (4T)	250		2006		R	
	M 300 EXC (2T)	300		2004		R	
	M 300 EXC Six Days (2T)	300		2011		R	
	M MX 300	300		2004		R	
	M 350 EXC-F (4T)	350		2011		R	
	M 350 EXC-F Six Days (4T)	350		2012		R	
	M SX-F 350	350		2011		R	
	M 350 XC-F	350		2011		R	
	M 350 XCF W	350		2011		R	
	M EXC 400	400		2006		R	
	M 450 EXC (4T)	450		2004		R	
	M 450 EXC Six Days (4T)	450		2011		R	
	M MXC 450	450		2003		R	
	M 450 SMR	450		2007		R	
	M SX 450 / F	450		2003		R	
	M SX-F 450	450		2007		R	
	M 500 EXC (4T)	500		2012		R	
	M 500 EXC Six Days (4T)	500		2012		R	
	M 500 XC-W	500		2012		R	
	M SX / MX 525	525		2003		R	
	M 560 SMR	560		2007		R	
RIEJU	M MARATHON 250	250		2010		R	
	M MARATHON 450	450		2010		R	
	M MARATHON 450 Motard	450		2010		R	

4242

FERODO

RACING

Updated on November 2020

M = MOTORCYCLE
S = SCOOTER
A = ATV
Sn = SNOWMOBILE

		CC	KW	FROM	TO	FRONT / REAR	LEFT / RIGHT
SHERCO	M SE-R 125	125		2017		R	
	M SE250 i (2T/Brembo Rear Caliper)	250		2012		R	
	M SE-R 250 (2T)	250		2012		R	
	M SEF 250 (4T)	250		2013		R	
	M SEF-R 250 (4T)	250		2013		R	
	M SE300 i (2T/Brembo Rear Caliper)	300		2012		R	
	M SE-R 300 (2T)	300		2012		R	

		CC	KW	FROM	TO	FRONT / REAR	LEFT / RIGHT
SWM	M SEF 300 (4T)	300		2013		R	
	M SEF-R 300 (4T)	300		2013		R	
	M SEF-R 450	450		2015		R	
	M RS 300 R (4T)	300		2015		R	
	M RS 500 R	500		2015		R	
	M SM 500 R	500		2015		R	

FDB2166

43.3 x 48.9 x 9.9 mm

Set=4 Pads

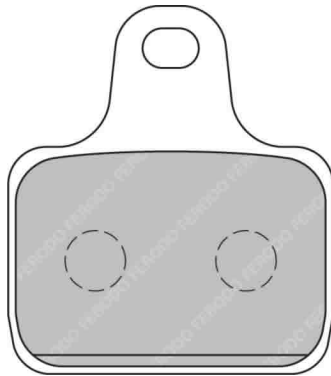

MATERIAL AVAILABILITY											
AG	EF	P	PRP	ST	SM	SG	ZR	XRAC	ZRAC	CP1	CPRO
								✓		⚠	✓

Pinze / Calipers

AP/LOCKHEED

4 Piston Radial Mount CP6688 (4 pads required)

BREMBO

2 Piston P2 34 XA0xxxx radial mount (2 pads required)

4 Piston P34/34 X00.C04&X99C4 radial mount (4 pads required)

PVM

2-Piston, rear Caliper (2 pads required)

4 Piston Radial Mount Caliper (4 pads required)

CROSS REFERENCE

BREMBO	07.7874.24
CL BRAKES	1075
EBC	FA435/4HH
GOLD FREN	239
LUCAS/TRW	MCB790
NEWFREN	FD0370
SBS	805
VESRAH	VD-9011

		CC	KW	FROM	TO	FRONT / REAR	LEFT / RIGHT
MV AGUSTA	M F4 1000 VELTRO	998		2008	2008	F	

		CC	KW	FROM	TO	FRONT / REAR	LEFT / RIGHT
	M F4 100 CC	1078		2007	2008	F	

M = MOTORCYCLE
S = SCOOTER
A = ATV
Sn = SNOWMOBILE

FDB2167

100.7 x 34.3 x 9.0 mm

replacing FDB2043

MATERIAL AVAILABILITY											
AG	EF	P	PRP	ST	SM	SG	ZR	XRAC	ZRAC	CP1	CPRO
								✓		✓	

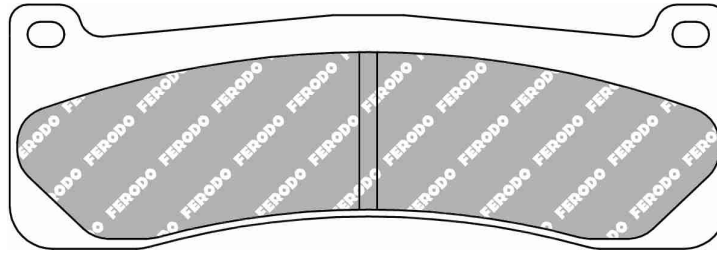

Pinze / Calipers

AP RACING

CP4466/4477 (6 Piston)

Lockheed

6-Piston (new for 2003)

PFM

Kawasaki SBK caliper 2009

Narrow Blade Billet 6-Piston - Superbike

CROSS REFERENCE

CL BRAKES	2720
EBC	EPFA263HH
NEWFREN	FD0369
SBS	707
VESRAH	VD-961



HONDA-HM ITALIA | M | CRE Baja RR HM 125 4T

CC	KW	FROM TO		FRONT / REAR		LEFT / RIGHT	
		2011		F			
125		2011		F			

FDB2168

76.6 x 40.5 x 8.0 mm

MATERIAL AVAILABILITY											
AG	EF	P	PRP	ST	SM	SG	ZR	XRAC	ZRAC	CP1	CPRO
								✓			

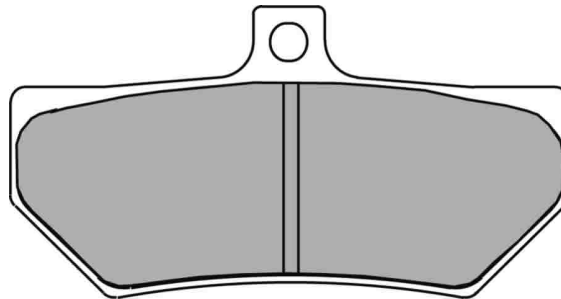

Pinze / Calipers

Lockheed

Radial Mount 4 pot (new '04)

CROSS REFERENCE

NEWFREN	FD0368
---------	--------

FDB2169

111.4 x 36.3 x 7.6 mm / 98.8 x 33.3 x 7.6 mm

May 2016: AG superseded by EF

MATERIAL AVAILABILITY											
AG	EF	P	PRP	ST	SM	SG	ZR	XRAC	ZRAC	CP1	CPRO
✗	✓	✓									

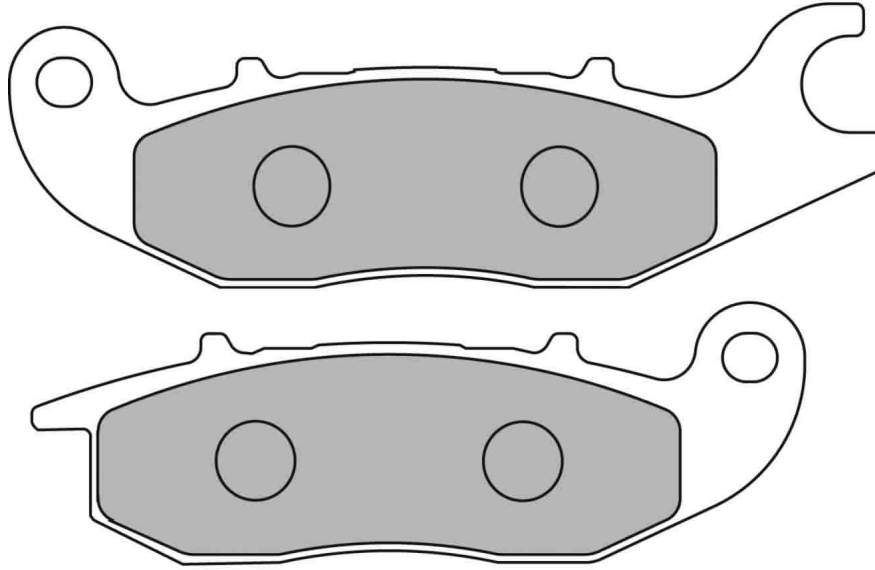

ALSO AVAILABLE		
SHAPE	TH. MM	NOTES
FDB2242		Coupled set

CROSS REFERENCE	
BRAKING	902
BREMBO	07HO56
BRENTA	3147
BRENTA	4147
CL BRAKES	1148
EBC	FA375
GALFER	FD298
GOLD FREN	210
LUCAS/TRW	MCB759
NEWFREN	FD0355
SBS	180
SBS	797
VESRAH	VD-177

		CC	KW	FROM	TO	FRONT / REAR	LEFT / RIGHT
	AKT	M	AK 125 Flex	125			F
	HERO	M	Karizma ZMR 230	320	2011	2012	F
	HONDA	S	Aviator	110	2009		F
		M	CB Shine	125	2010		F
		M	CBF 125 M	125	2009		F
		M	CBR 125 R	125	2004	2010	F
		M	CBR 125 R	125	2011	2016	F
		M	FS 125 Sonic	125	2003	2004	R
		M	ANF 125 INNOVA	125	2003	2011	F
		S	Monkey	125	2019		F

		CC	KW	FROM	TO	FRONT / REAR	LEFT / RIGHT
		M	MSX 125	125	7,2	2017	F
		M	CBR 150 R	150		2000 2003	F
		M	CRF 250 Rallye	250	18	2015	F
	LIFAN	M	Smart 50/125	125			F
	RIEJU	M	RS2 50 MATRIX / PRO 50 (JJUAN)	50		2007 2008	F
		M	RS2 50 FR / PRO	50		2008	F
		M	RS2 50 PRO	50		2009	F
		M	NKD 125	125		2008	F
		M	RS2 125 / PRO 125 (JJUAN)	125		2007 2008	F

M = MOTORCYCLE
S = SCOOTER
A = ATV
Sn = SNOWMOBILE

FDB2170

49.8 x 31.8 x 8.1 mm

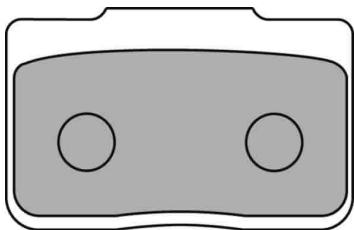

MATERIAL AVAILABILITY												
AG	EF	P	PRP	ST	SM	SG	ZR	XRAC	ZRAC	CP1	CPRO	
		✓										

Pinze / Calipers

BREMBO

Brembo Racing, Billet 4x24mm rear: GP4-24 (4 piston)

CROSS REFERENCE

BREMBO	07.9340.20
NEWFREN	FD0366
VESRAH	VD-9005

FDB2171

37.8 x 29.2 x 7.7 mm

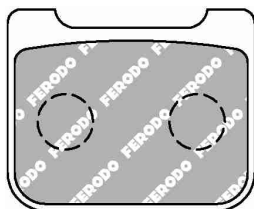

MATERIAL AVAILABILITY												
AG	EF	P	PRP	ST	SM	SG	ZR	XRAC	ZRAC	CP1	CPRO	
		✓										

Pinze / Calipers

BREMBO

Brembo Racing, Billet 2x24mm rear: GP24 (2 piston)

CROSS REFERENCE

BREMBO	07.9340.90
GALFER	FD181
NEWFREN	FD0367
SBS	732

FDB2173

88.0 x 46.0 x 8.5 mm

MATERIAL AVAILABILITY											
AG	EF	P	PRP	ST	SM	SG	ZR	XRAC	ZRAC	CP1	CPRO
	✓			✓	✓						

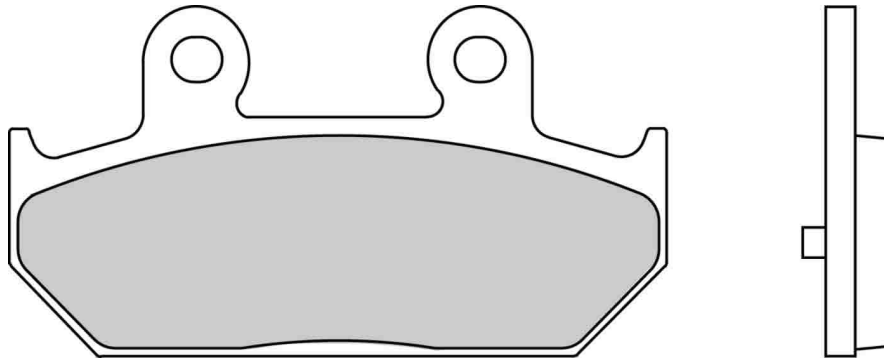

ALSO AVAILABLE		
SHAPE	TH. MM	NOTES
FDB452	8.5	no pin on the backplate
FDB663	9.8	no pin on the backplate

CROSS REFERENCE	
BRAKING	896
BREMBO	07058
BREMBO	7058
CL BRAKES	3066
EBC	FA412
GOLD FREN	265
LUCAS/TRW	MCB751
NEWFREN	FD0356
SBS	182
SBS	804
VESRAH	VD-357

		CC	KW	FROM	TO	FRONT / REAR	LEFT / RIGHT
SUZUKI	M	AN 250 Skywave Type M (BA-CJ45A)	250		2007	2008	R
	M	AN 250 Skywave Type S (BA-CJ44A)	250		2007	2008	R
	M	AN 250 8 Skywave SS	250		2008		R
	M	AN 400 BURGMAN/SKYWAVE NO ABS	400		2007		R

		CC	KW	FROM	TO	FRONT / REAR	LEFT / RIGHT
M	AN 400 BURGMAN/SKYWAVE ABS	400		2007			R
S	BURGMAN 400 ABS	400		2017			R
S	AN 650 BURGMAN Std/Skywave No ABS	650		2003			R
S	AN 650 BURGMAN Executive/Skywave ABS	650		2004			R

M = MOTORCYCLE
S = SCOOTER
A = ATV
Sn = SNOWMOBILE

FDB2175

67.7 x 45.1 x 7.6 mm

MATERIAL AVAILABILITY											
AG	EF	P	PRP	ST	SM	SG	ZR	XRAC	ZRAC	CP1	CPRO
						✓					

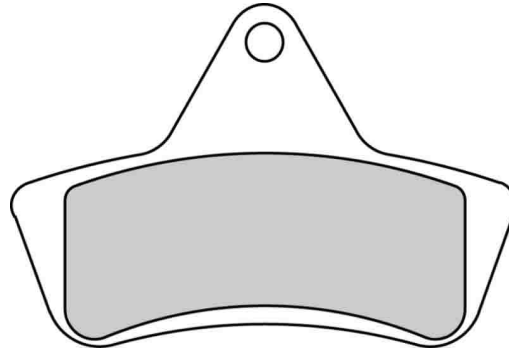

Pinze / Calipers



WILWOOD

PS-1 Calipers

CROSS REFERENCE

BREMBO	07GR54
CL BRAKES	2926
EBC	FA271
GALFER	FD302
LUCAS/TRW	MCB763
NEWFREN	FD0309
SBS	758
VESRAH	VD-965

		CC	KW	FROM	TO	FRONT REAR	LEFT RIGHT
	ARCTIC CAT	A 250 (2x4/4x4)	250	1999	2004	F	
		A 250 (2x4/4x4)	250	1999	2004	R	
		A 300 (2x4/4x4)	300	1998	2004	F	
		A 300 (2x4/4x4)	300	1998	2004	R	
		A 375 (Auto)	375	2001		F	
		A 375 (Auto)	375	2001		R	
		A 400 (2x4/4x4)	400	1998	2004	F	
		A 400 (2x4/4x4)	400	1998	2004	R	
		A 440 (4x4)	440	2002	2003	F	
		A 440 (4x4)	440	2002	2003	R	
		A BEAR CAT 450 (2x4/4x4)	450	1996	1997	F	

		CC	KW	FROM	TO	FRONT REAR	LEFT RIGHT
		A BEAR CAT 450 (2x4/4x4)	450	1996	1997	R	
		A BEAR CAT 454 (2x4/4x4)	454	1996	2000	F	
		A BEAR CAT 454 (2x4/4x4)	454	1996	2000	R	
		A 500 (4x4,Manual,Auto)	500	1998	2004	F	
		A 500 (4x4,Manual,Auto)	500	1998	2004	R	
		A 650 H1 4 X 4 Auto LE Utility	650	2007		F	
		A 650 H1 4 X 4 Auto LE Utility	650	2007		R	
	LAVERDA ATV	A QUASAR 400 4x4	400	2004		F	
		A QUASAR 400 4x4	400	2004		R	
		A QUASAR 500 4x4	500	2004		F	

FDB2176

91.0 x 41.9 x 8.3 mm

MATERIAL AVAILABILITY											
AG	EF	P	PRP	ST	SM	SG	ZR	XRAC	ZRAC	CP1	CPRO
						✓					

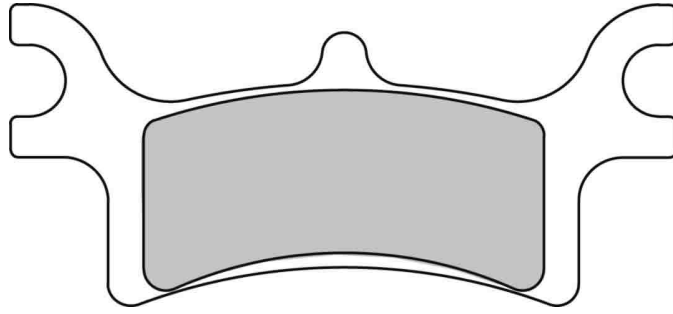



Pinze / Calipers

WILWOOD

DH4 Calipers

CROSS REFERENCE	
BREMBO	07PO06
CL BRAKES	1165
EBC	FA314
GALFER	FD317
NEWFREN	FD0346
SBS	787
VESRAH	VD-992

		CC	KW	FROM	TO	FRONT / REAR	LEFT / RIGHT
 POLARIS ATV	A	MAGNUM (All models)		2002	2006	R	
	A	TRAIL BLAZER 250	250	2005	2006	R	
	A	XPEDITION 325	325	2002		R	
	A	Trail Blazer 330	330	2008	2010	R	
	A	TRAIL BOSS 330	330	2005	2010	R	
A	SPORTSMAN 400	400	2003	2005	R		

		CC	KW	FROM	TO	FRONT / REAR	LEFT / RIGHT
 SPORTSMAN	A	Sportsman 450	450		2006		R
	A	SCRAMBLER 500 (All models)	500	2005	2010		R
	A	SPORTSMAN 500 HO/EFI/X2/EFI Quad H.O.	500	2003	2010		R
	A	SPORTSMAN 600	600	2003	2006		R
	A	SPORTSMAN 700	700	2003	2007		R
	A	SPORTSMAN 800 EFI/HO	800	2005	2010		R

M = MOTORCYCLE
 S = SCOOTER
 A = ATV
 Sn = SNOWMOBILE

FDB2178

71.7 x 50.3 x 7.8 mm

MATERIAL AVAILABILITY											
AG	EF	P	PRP	ST	SM	SG	ZR	XRAC	ZRAC	CP1	CPRO
				✓				✓	✓		

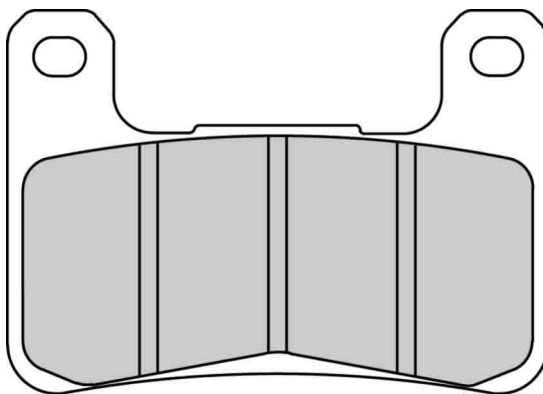

ALSO AVAILABLE		
SHAPE	TH. MM	NOTES
FDB2204	9.3	Racing Applications

CROSS REFERENCE	
BRAKING	898
BREMBO	07SU27
BRENTA	3117
BRENTA	4117
CL BRAKES	1133
EBC	FA379
GALFER	FD325
GOLD FREN	213
LUCAS/TRW	MCB752
NEWFREN	FD0362
SBS	806
VESRAH	VD-355

		CC	KW	FROM	TO	FRONT / REAR	LEFT / RIGHT	
	M Z 900 RS	948	82	2018		F		
	M Z 900 RS Cafe	948	82	2018		F		
	M Ninja H2 SX	998	147	2018		F		
	M Ninja H2 SX SE	998	147	2018		F		
	M Z1000 Sugomi Ed.	1000		2016		F		
	M Z 1000 / ABS / SX	1000		2010		F		
	M Z 1000 SX	1000		2017		F		
	M ZX-10R 1000	1000	149	2008	2010	F		
	M ZX-10R 1000	1000	149	2011	2015	F		
	M Ninja 1000 SX	1043		2020		F		
	M Versys 1000	1043	88	2019		F		
	M Versys 1000 SE	1043	88	2019		F		
		M GSX-R 600	600		2004	2005	F	
		M GSX-R 600	600		2006	2010	F	
M DL 1000 V-STROM ABS (DD1)		1000	74	2014		F		

		CC	KW	FROM	TO	FRONT / REAR	LEFT / RIGHT
	M GSX-R 1000	1000		2004	2006	F	
	M GSX-R 1000	1000		2007	2008	F	
	M GSX-R 1000	1000		2009	2011	F	
	M GSX-R 1000 Yoshimura 2008	1000		2010		F	
	M GSX-R 1000 Alstare 25 Ann.	1000		2010		F	
	M V-Strom 1000 ABS	1037		2016		F	
	M V-Strom 1000-XT ABS	1037		2016		F	
	M V-Strom 1050	1050		2020		F	
	M GSX-R 1300 HAYABUSA (Tokico Front std caliper)	1300		2008	2012	F	
	M GSX-R 1300	1300		2008		F	
	M M 1800 R INTRUDER (VRZ)	1800		2006	2009	F	
	M M 1800 RZ INTRUDER (VRZ)	1800		2007	2013	F	
	M M 1800 R2 INTRUDER (VRZ)	1800		2008	2009	F	
	M M 1800 RB INTRUDER (VZR)	1800		2014		F	

FDB2179

102.1 x 46.3 x 8.9 mm

Re-fit OEM backing shim to back-plate

MATERIAL AVAILABILITY											
AG	EF	P	PRP	ST	SM	SG	ZR	XRAC	ZRAC	CP1	CPRO
		✓		✓							

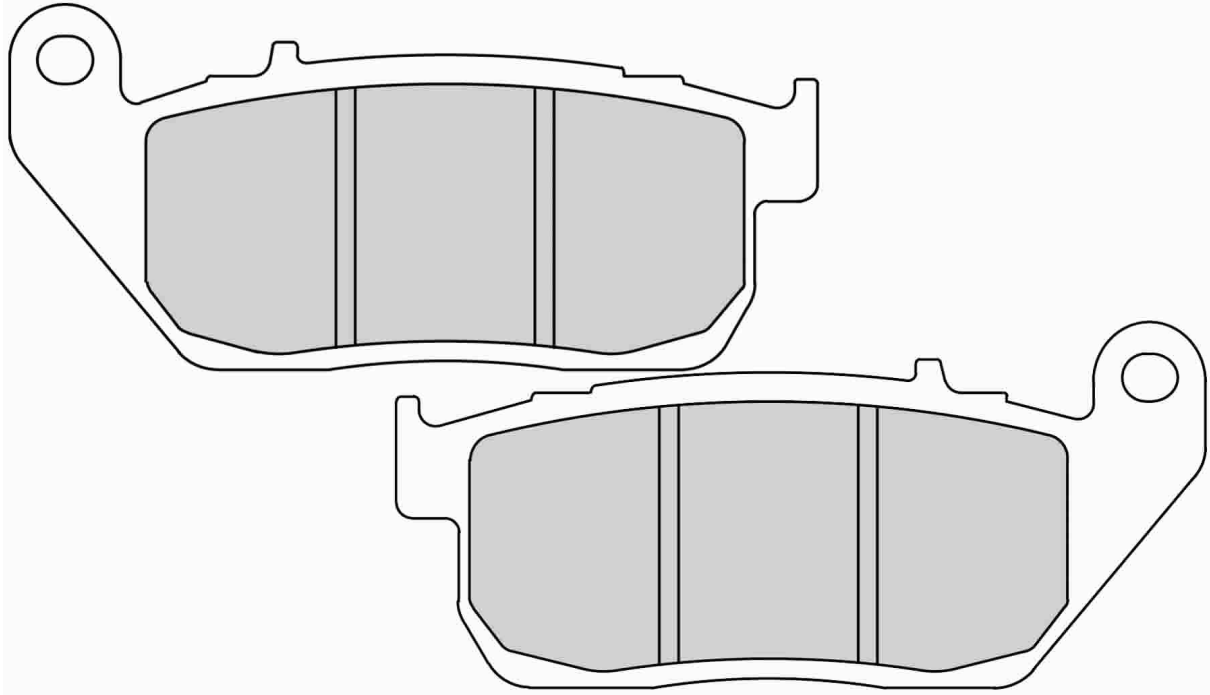

CROSS REFERENCE	
BRAKING	900
BREMBO	07HD13
BRENTA	4166
CL BRAKES	1149
EBC	FA381
GALFER	FD339
LUCAS/TRW	MCB753
NEWFREN	FD0387
SBS	807
VESRAH	VD-9009

		CC	KW	FROM	TO	FRONT / REAR	LEFT / RIGHT
	HARLEY DAVIDSON	M XL 883	883	2004	2008	F	
		M XL 883 C Sportster Custom	883	2004	2008	F	
		M XL 883 L Low	883	2004	2010	F	
		M XL 883 SPORTSTER R	883	2005	2013	F	
		M XL 883 N Iron	883	39	2009	2010	F
		M XL 883 L Superlow	883	2011	2013	F	
		M XL 883 N Iron (Cast Wheel)	883	2011	2013	F	
		M XL 883 R Roadster (Cast Wheel)	883	2011	2013	F	
		M XL 1200 C Sportster Custom	1200	2004	2010	F	

		CC	KW	FROM	TO	FRONT / REAR	LEFT / RIGHT
		M XL 1200 R Sportster Roadster	1200	2004	2008	F	
		M XL 1200 L Sportster Low (Cast Wheel)	1200	2007	2011	F	
		M XL 1200 L Sportster Low (Spoke Wheel)	1200	2007	2011	F	
		M XL 50 50th Anniversary Sportster	1200	2007	2007	F	
		M XL 1200 N Nightster (Spoke wheel)	1200	2008	2012	F	
		M XL 1200 X - Forty Eight	1200	49	2010	2013	F
		M XL 1200 C Sportster Custom (Cast& Spoke Wheels)	1200	2011	2013	F	
		M XL 1200 V - Seventy Two	1200	2012	2013	F	

M = MOTORCYCLE
S = SCOOTER
A = ATV
Sn = SNOWMOBILE

FDB2180

86.3 x 44.9 x 10.0 mm

MATERIAL AVAILABILITY

AG	EF	P	PRP	ST	SM	SG	ZR	XRAC	ZRAC	CP1	CPRO
		✓		✓							

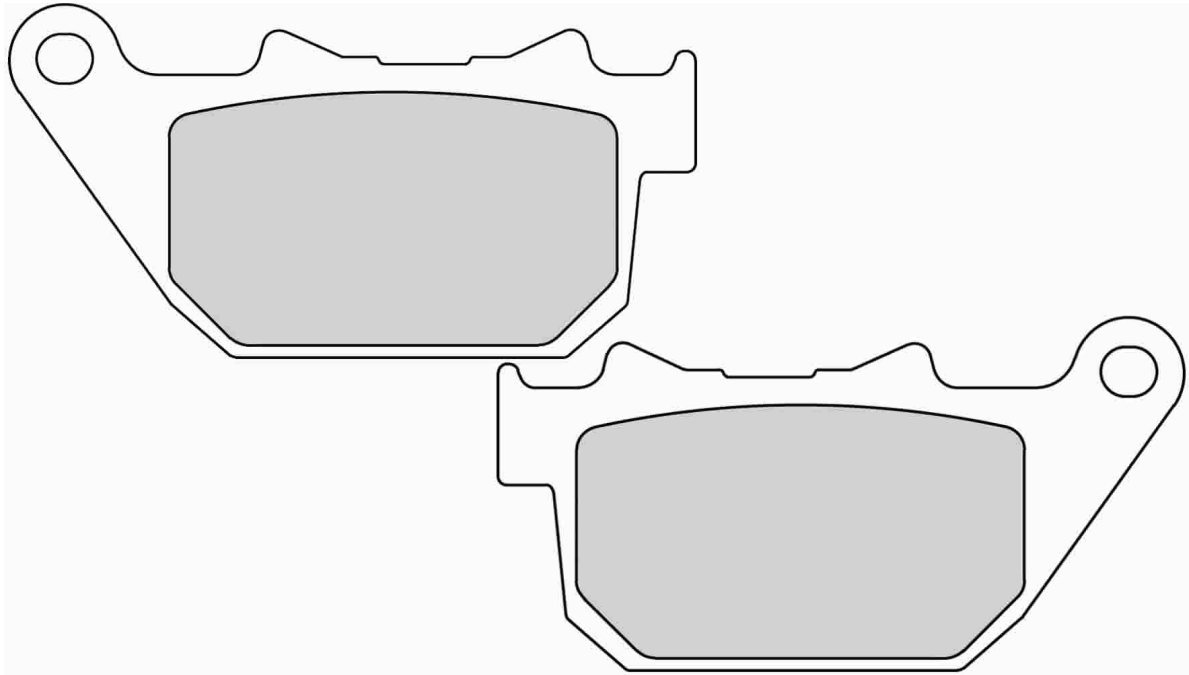

CROSS REFERENCE

BRAKING	901
BREMBO	07HD14
BRENTA	4167
CL BRAKES	1150
EBC	FA387
GALFER	FD340
LUCAS/TRW	MCB754
NEWFREN	FD0386
SBS	808
VESRAH	VD-9010

		CC	KW	FROM	TO	FRONT / REAR	LEFT / RIGHT
	HARLEY DAVIDSON						
M	XL 883	883		2004	2008	R	
M	XL 883 C Sportster Custom	883		2004	2008	R	
M	XL 883 L Low	883		2004	2010	R	
M	XL 883 SPORTSTER R	883		2005	2013	R	
M	XL 883 N Iron	883	39	2009	2010	R	
M	XL 883 L Superlow	883		2011	2013	R	
M	XL 883 N Iron (Cast Wheel)	883		2011	2013	R	
M	XL 883 R Roadster (Cast Wheel)	883		2011	2013	R	
M	XL 1200 C Sportster Custom	1200		2004	2010	R	
M	XL 1200 R Sportster Roadster	1200		2004	2008	R	

		CC	KW	FROM	TO	FRONT / REAR	LEFT / RIGHT
							
M	XL 1200 L Sportster Low (Cast Wheel)	1200		2007	2011	R	
M	XL 1200 L Sportster Low (Spoke Wheel)	1200		2007	2011	R	
M	XL 50 50th Anniversary Sportster	1200		2007	2007	R	
M	XL 1200 N Nightster (Spoke wheel)	1200		2008	2012	R	
M	XL 1200 X - Forty Eight	1200	49	2010	2013	R	
M	XL 1200 C Sportster Custom (Cast& Spoke Wheels)	1200		2011	2013	R	
M	XL 1200 V - Seventy Two	1200		2012	2013	R	
M	XR 1200	1200		2008	2010	R	
M	XR 1200 X	1200		2010	2012	R	

FDB2181

74.6 x 47.4 x 8.0 mm

October 2020:ZRAC version available as FDB2205

MATERIAL AVAILABILITY											
AG	EF	P	PRP	ST	SM	SG	ZR	XRAC	ZRAC	CP1	CPRO
				✓				✓			

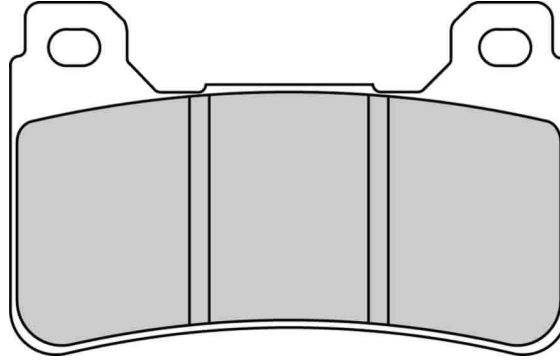

ALSO AVAILABLE		
SHAPE	TH. MM	NOTES
FDB2205	9.0	Racing Applications

CROSS REFERENCE	
BRAKING	899
BREMBO	07HO50
BRENTA	3116
BRENTA	4116
CL BRAKES	1134
EBC	FA390
GALFER	FD326
GOLD FREN	214
LUCAS/TRW	MCB755
NEWFREN	FD0364
SBS	809
VESRAH	VD-170

		CC	KW	FROM	TO	FRONT REAR	LEFT RIGHT	
	HONDA							
	M	CBR 600 RR	600		2005	2006	F	
	M	CBR 600 RR / Lim. Ed. / Fireblade Repsol	600		2007		F	
	M	VFR 800 F	800		2014	2017	F	
	M	VFR 800 X Crossrunner	800		2015		F	
M	VFR 800 X Crossrunner Travel Edition	800		2015		F		

		CC	KW	FROM	TO	FRONT REAR	LEFT RIGHT
	M	CB 1000 R (No ABS)	1000		2009		F
	M	CBR 1000 FIREBLADE	1000		2004	2005	F
	M	CBR 1000 RR FIREBLADE / Hansspree Ed.	1000		2006	2013	F
	M	CBR 1000 RR Fireblade	1000	141	2014		F

M = MOTORCYCLE
S = SCOOTER
A = ATV
Sn = SNOWMOBILE

FDB2182

75.4 x 39.7 x 9.7 mm

MATERIAL AVAILABILITY											
AG	EF	P	PRP	ST	SM	SG	ZR	XRAC	ZRAC	CP1	CPRO
						✓					

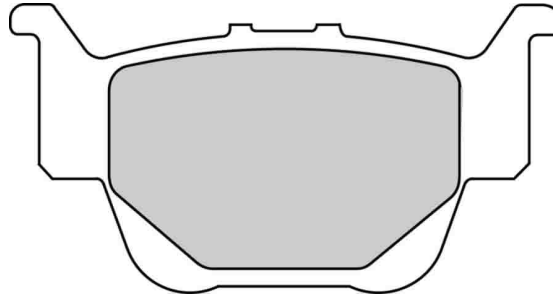

CROSS REFERENCE	
BRAKING	911
BREMBO	07HO55
CL BRAKES	1140
EBC	FA373
LUCAS/TRW	MCB769
NEWFREN	FD0376
SBS	813
VESRAH	VD-171

		CC	KW	FROM	TO	FRONT / REAR	LEFT / RIGHT
 HONDA ATV	A	TRX 420 FA/FPA P.S.Fourtrax Rancher	420		2009	2010	R
	A	TRX 450 R/ER	450		2004	2009	R
	A	TRX 650 FA Rincon / FGA Fourtrax Rincon Gpscape	650		2003	2005	R

		CC	KW	FROM	TO	FRONT / REAR	LEFT / RIGHT
	A	TRX 680 Fourtrax Rincon Gpscape	680		2006	2009	R
	A	TRX 680 Fourtrax Rincon	680		2006	2010	R

FDB2183

43.6 x 25.3 x 5.0 mm

MATERIAL AVAILABILITY											
AG	EF	P	PRP	ST	SM	SG	ZR	XRAC	ZRAC	CP1	CPRO
						✓					

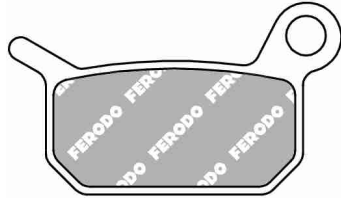
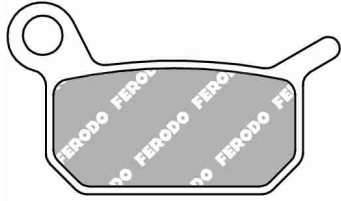

CROSS REFERENCE	
BRAKING	897
BREMBO	07GR70
BRENTA	3032
BRENTA	4032
CL BRAKES	1128
EBC	FA325
LUCAS/TRW	MCB750
NEWFREN	FD0372
SBS	794
VESRAH	VD-9006
VESRAH	VD-991

		CC	KW	FROM	TO	FRONT / REAR	LEFT / RIGHT
	HUSQVARNA						
M	CR 50 Senior Pro	50		2005		R	
M	CR 50	50		2010	2013	F	
M	CR 50	50		2010	2013	R	
M	SM 50	50		2010	2013	F	
M	SM 50	50		2010	2013	R	
M	TC 50	50		2017		F	
M	TC 50	50		2017		R	

		CC	KW	FROM	TO	FRONT / REAR	LEFT / RIGHT
	KTM						
M	50 SX SENIOR ADVENTURE	50		2002	2007	F	
M	50 SX PRO SENIOR LC	50		2002	2003	F	
M	50 SX PRO SENIOR LC (12" Front Wheel)	50		2004		F	
M	50 SX PRO SENIOR LC (12" Front Wheel)	50		2004		R	
M	SX 65	65		2004	2009	R	
LEM	M R2 / R3	50		2003		F	
M	R2 / R3	50		2003		R	

M = MOTORCYCLE
S = SCOOTER
A = ATV
Sn = SNOWMOBILE

FDB2184

73.3 x 47.3 x 10.9 mm / 94.4 x 47.5 x 8.6 mm

MATERIAL AVAILABILITY											
AG	EF	P	PRP	ST	SM	SG	ZR	XRAC	ZRAC	CP1	CPRO
		✓				✓					

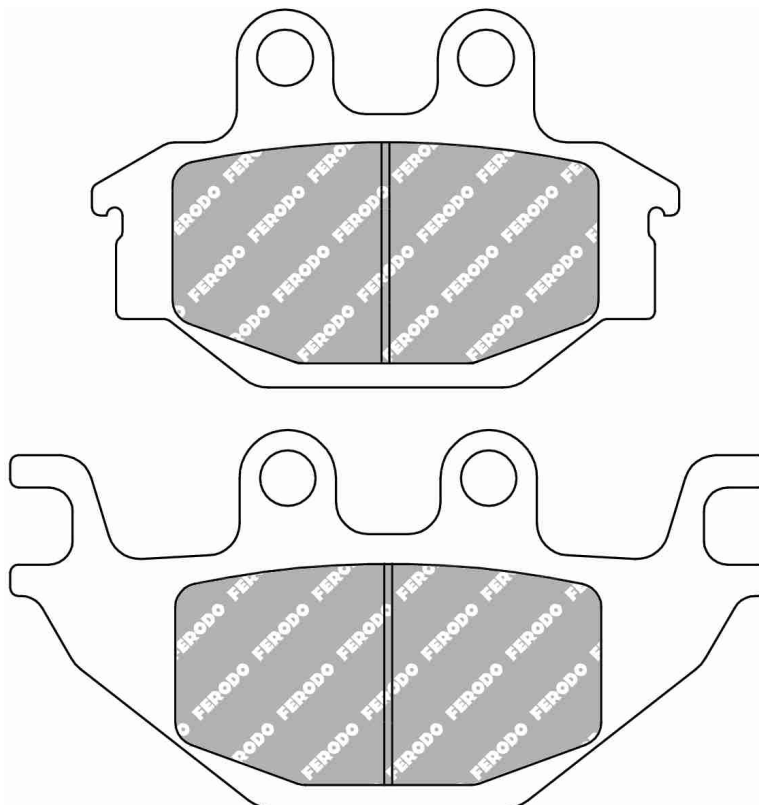

CROSS REFERENCE	
BRAKING	923
BREMBO	07GR52
BREMBO	07GR81
BRENTA	3133
BRENTA	4133
CL BRAKES	1147
EBC	FA377
GALFER	FD336
GOLD FREN	230
LUCAS/TRW	MCB760
NEWFREN	FD0383
SBS	810
VESRAH	VD-9026

		CC	KW	FROM	TO	FRONT / REAR	LEFT / RIGHT
	ARCTIC CAT	A 250 DVX	250	2006	2008	F	
		A 250 Utility 2 x 4	250	2006	2009	F	
		A 250 Utility 2 x 4	250	2006	2009	R	
		A 300 DVX	300	2009	2010	F	
BOMBARDIER ATV	A DS 250	250	2006	2007	F		
	A DS 250	250	2006	2007	R		
CAN AM ATV	A DS 250	250	2007	2009	F		
	A DS 250	250	2007	2009	R		
CPI ATV	A 250 XS	250	2006		F		
KYMGCO	S AGILITY maxi 300i ABS	300	2015		R		
KYMCO ATV	A KXR 250 MONGOOSE	250	2004	2009	F		
	A MXU 250	250	2004	2013	F		
	A MXU 250 R	250	2012	2013	F		
	A MXU 250 R	250	2012	2013	R		
	A URBAN 250	250	2006	2007	F		
	A MAXXER 300	300	2006	2013	F		
	A Mongoose 300	300	2006	2010	F		
	A MXU 300	300	2006	2011	F		
	A MXU 300	300	2006	2011	R		

		CC	KW	FROM	TO	FRONT / REAR	LEFT / RIGHT
	A MXU 300 R	300	2010		F		
	A MXU 300 R	300	2010		R		
	A MXU 400	400	2008	2011	F		
	A MXU 400	400	2008	2011	R		
	A MXU 500 (L70000/Carb Model/4x4)	500	2005	2013	F		
	A MXU 500 (L70000/Carb Model/4x4)	500	2005	2013	R		
	A MXU 500i DX Parking Brake	500	2012	2013	F		
	A MXU 500i IRS Parking Brake	500	2012	2013	F		
	A UXV 500 (Side x Side/4x4/U10000)	500	2008	2009	F		
	A UXV 500 (Side x Side/4x4/U10000)	500	2008	2009	R		
	A UXV 500i (Side x Side/4x4/U10100)	500	2010		F		
	A UXV 500i (Side x Side/4x4/U10100)	500	2010		R		
	A MXU 550i Parking Brake	550	2012	2012	F		
	A MXU 550i (4x4 LoF) Parking Brake	550	2013		F		
	A MXU 700i (4x4 LoF) Parking Brake	700	2013		F		
	A UXV 700i (Turf) Parking Brake	700	2014		F		
PGO ATV	A BR 500i Racer	500	2007	2009	R		
	A 500 Bug	500	2008	2009	R		
	A BR 600i Racer	600	2012	2012	R		

		CC	KW	FROM	TO	FRONT / REAR	LEFT / RIGHT
	QUADZILLA	A RS 7 4WD	700	2010	2011	F	
		A X7 R	700	2010	2011	F	
		A RS 8	800	2010	2011	F	
SYM	M SB 125 Ni - Wolf (EFi Model)	125	2011			R	
	M SB250 Ni - Wolf	250	2012			R	
	M SB300 Cafe' Racer	300	2016			R	
	S Wolf 300 i Cafe' Racer	300	2015			R	
SYM ATV	A Quadlander 200	200	2012	2013		F	
	A Trackrunner 200 Quad	200	2005	2009		F	
	A Quadlander 250	250	2005	2009		F	
	A Citymax 300 Quad	300	2006			F	
	A Quadlander 300	300	2007	2010		F	
	A Quadlander 300	300	2007	2010		R	
	A Quadlander 300 S	300	2007			F	
	A Quadlander 300 S	300	2007			R	
	A Quadlander 600	600	2008	2010		R	
	A Quadraider 600	600	2006	2007		R	
	A Quadraider 600	600	2008			F	
	A Quadraider 600	600	2008			R	
	A Quadraider 600LE	600	2010			F	
	A Quadraider 600LE	600	2010			R	
	TGB ATV	A Avenger400 Quad (4x2)	400	2007	2009		F
A Avenger400 Quad (4x2)		400	2007	2009		R	
A Avenger400 LE Quad (4x2)		400	2009	2010		F	
A Avenger400 LE Quad (4x2)		400	2009	2010		R	
A Blade(4x4) 425 Quad		425	2007	2009		F	
A Blade(4x4) 425 Quad		425	2007	2009		R	
	A BladeSE (4x4) 425 Quad	425	2009	2010		F	

		CC	KW	FROM	TO	FRONT / REAR	LEFT / RIGHT
	A BladeSE (4x4) 425 Quad	425	2009	2010		R	
	A Outback 425 C 4x4	425	2007	2009		F	
	A Outback 425 C 4x4	425	2007	2009		R	
	A Outback 425 SE 4x4 Auto	425	2007	2009		F	
	A Outback 425 SE 4x4 Auto	425	2007	2009		R	
	A Outback 425 Real Tree Camo Edition 4x4 Auto	425	2007	2009		F	
	A Outback 425 Real Tree Camo Edition 4x4 Auto	425	2007	2009		R	
	A Blade450 SE (4x4)	450	2010	2011		F	
	A Blade460 SL IRS 4x4	460	2012			F	
	A Avenger500 R Quad (4x2)	500	2009	2010		F	
	A Avenger500 R Quad (4x2)	500	2009	2010		R	
	A Blade510 LE	510	2011	2012		F	
	A 525SE 4X4	525	2009			F	
	A Blade525 SE 4X4	525	2009	2010		F	
	A Blade525 SE 4X4	525	2009	2010		R	
	A Blade525 SL 4X4	525	2009	2010		F	
	A Blade550 SE 4X4	550	2009	2011		F	
	A Blade550 SL 4X4	550	2009	2010		F	
	A 550IRS Blade LT	550	2010	2012		F	
	A Blade550 LT 4X4	550	2010	2012		F	
A Blade550 IRS Target	550	2011	2012		F		
A Gunner550 4 X 4 Target	550	2010	2012		F		
A Gunner550 4 X 4 Target	550	2010	2012		R		
YAMAHA	M MT-125 (RE11)	125	11	2015	2019	R	
	M MT-125A (RE11) ABS	125	11	2015	2019	R	
	M YZF-R 125	125		2008	2013	R	
	M YZF-R 125	125		2014	2018	R	

FDB2185

64.1 x 48.3 x 8.1 mm

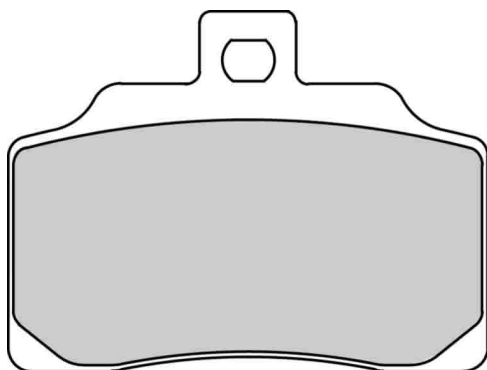

MATERIAL AVAILABILITY

AG	EF	P	PRP	ST	SM	SG	ZR	XRAC	ZRAC	CP1	CPRO
		✓									

CROSS REFERENCE

EBC	FA426
NEWFREN	FD0379

		CC	KW	FROM	TO	FRONT / REAR	LEFT / RIGHT
	BETA	M M4 Supermotard	350	2004	2006	F	

		CC	KW	FROM	TO	FRONT / REAR	LEFT / RIGHT
	M	M4 Supermotard	350	2006	2012	F	

M = MOTORCYCLE
S = SCOOTER
A = ATV
Sn = SNOWMOBILE

FDB2186

97.1 x 41.2 x 9.0 mm / 77.2 x 41.2 x 9.0 mm

MATERIAL AVAILABILITY											
AG	EF	P	PRP	ST	SM	SG	ZR	XRAC	ZRAC	CP1	CPRO
✓	✓				✓						

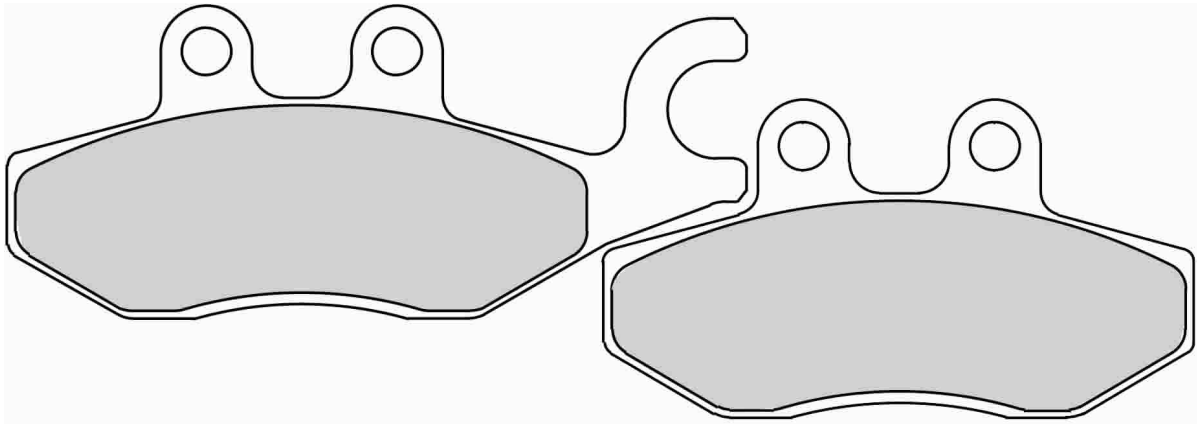

ALSO AVAILABLE		
SHAPE	TH. MM	NOTES
FDB2142		Coupled set

CROSS REFERENCE	
BRAKING	953
BREMBO	07060
BREMBO	7060
BRENTA	3097
BRENTA	4097
EBC	FA418
EBC	SFA418
GALFER	FD334
GOLD FREN	266
LUCAS/TRW	MCB771
NEWFREN	FD0365
SBS	187
SBS	818

		CC	KW	FROM	TO	FRONT REAR	LEFT RIGHT
	PIAGGIO S Beverly RST 125 i.e. (4T 4V)(M69)	125	11	2010	2014	R	
	S Medley 125 i-get ABS (MA0A)	125	9	2016		R	
	S MP3 Hybrid 125	125		2010		R	
	M X9 125 Evolution	125		2004		F	right
	S X7 125cc	125		2008	2009	R	
	S X7 Evo 125 ie (EFi)	125		2009	2012	R	
	S X10 125 i.e. (4T 4V)	125		2012		R	
	S X10 125 i.e. (4T 4V)	125		2012		F	right
	S X10 EXECUTIVE (ABS-ASR) 125 i.e. (4T 4V)	125		2013		R	
	S X10 EXECUTIVE (ABS-ASR) 125 i.e. (4T 4V)	125		2013		F	right
	S Xevo 125	125		2007	2012	R	
	S 125 ie MP3 Yourban	125		2011	2012	R	
	S Medley 150 i-get ABS	150	11	2016		R	
	M X9 250 Evolution	250		2005		F	right
	M X7 250	250		2008		F	
	M X7 250	250		2008		R	
	M X-EVO 250 ie	250		2008		R	
	M Beverly 300 i.e. RST (M69)	300	16	2010		R	
	S Beverly 300 ie Police	300		2016		R	
	S MP3 LT 300 ie	300		2010	2011	R	
S MP3 Hybrid 300 ie 4T 4V	300		2010	2013	R		
S MP3 Hybrid LT 300 ie 4T 4V	300		2010	2011	R		
S MP3 MIC 300 ie	300		2010	2011	R		
S MP3 Touring 300 ie	300		2011	2012	R		
S MP3 Touring LT 300 ie	300		2011	2012	R		

		CC	KW	FROM	TO	FRONT REAR	LEFT RIGHT
	S MP3 300 ie LT Sport	300		2011	2013	R	
	S MP3 300 ie LT Sport ABS	300		2014		R	
	S MP3 300 ie LT Business ABS	300		2014		R	
	M X7 EVO 300	300		2010		R	
	S 300 ie MP3 Yourban	300		2011	2012	R	
	S 300 ie MP3 Yourban LT	300		2011		R	
	S 300 ie MP3 Yourban LT Sport	300		2015		R	
	M Beverly 350 (4T 4V)(M69) No ABS	350	25	2011		R	
	M Beverly 350 (4T 4V)(M69) ABS	350	25	2011		R	
	S Beverly 350 i.e. Sport Touring	350	25	2014		R	
	S Beverly 350 Tourer	350		2020		R	
	S X10 350 i.e. (4T 4V)	350		2012		R	
	S X10 350 i.e. (4T 4V)	350		2012		F	right
	S X10 EXECUTIVE (ABS-ASR) 350 i.e. (4T 4V)	350		2013		R	
	S X10 EXECUTIVE (ABS-ASR) 350 i.e. (4T 4V)	350		2013		F	right
	M X-EVO 400 ie	400		2008		F	right
	M X-EVO 400 ie	400		2008		R	
	S MP3 500 i.e. Bussines	500		2011	2012	R	
	S MP3 500 i.e. LT Bussines	500		2011	2013	R	
	S MP3 500 i.e. LT Sport	500		2011	2013	R	
S MP3 500 i.e. Sport	500		2012	2012	R		
S X10 500 i.e. (4T 4V)	500		2012		R		
S X10 500 i.e. (4T 4V)	500		2012		F	right	
S X10 EXECUTIVE (ABS-ASR) 500 i.e. (4T 4V)	500		2013		R		
S X10 EXECUTIVE (ABS-ASR) 500 i.e. (4T 4V)	500		2013		F	right	

FDB2188

94.5 x 35.8 x 7.3 mm / 119.7 x 26.6 x 6.8 mm

MATERIAL AVAILABILITY											
AG	EF	P	PRP	ST	SM	SG	ZR	XRAC	ZRAC	CP1	CPRO
						✓					

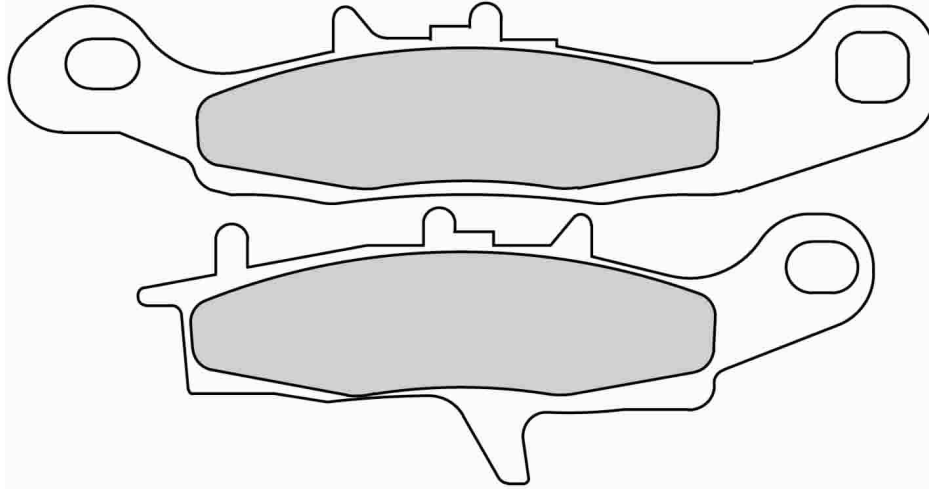

ALSO AVAILABLE		
SHAPE	TH. MM	NOTES
FDB2080		Coupled set

CROSS REFERENCE	
BREMBO	07KA25
CL BRAKES	1142
EBC	FA342
GALFER	FD319
LUCAS/TRW	MCB757
NEWFREN	FD0374
SBS	801
VESRAH	VD-441

		CC	KW	FROM	TO	FRONT REAR	LEFT RIGHT
	A KFX 450 R	450		2008	2012	F	left
	A KVF 650 PRAIRIE	650		2002	2003	F	left

		CC	KW	FROM	TO	FRONT REAR	LEFT RIGHT
	A KVF 650 BRUTE FORCE	650		2005	2007	F	left
	A KFX 700	700		2004	2009	F	left

FDB2189

57.9 x 78.3 x 11.6 mm

MATERIAL AVAILABILITY

AG	EF	P	PRP	ST	SM	SG	ZR	XRAC	ZRAC	CP1	CPRO
						✓					

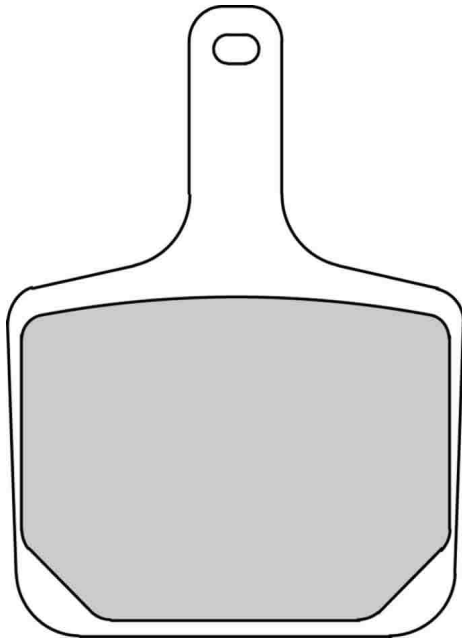

CROSS REFERENCE

GALFER	FD296
NEWFREN	FD0381



CC	KW	FROM	TO	FRONT / REAR	LEFT / RIGHT
POLARIS SNOWMOBILE	Sn	ALL MODELS WITH PHANTOM BRAKES		2003	R

FDB2190

70.2 x 41.5 x 8.2 mm / 85.2 x 43.2 x 8.2 mm

January 2018: AG superseded by EF

MATERIAL AVAILABILITY											
AG	EF	P	PRP	ST	SM	SG	ZR	XRAC	ZRAC	CP1	CPR0
✗	✓										

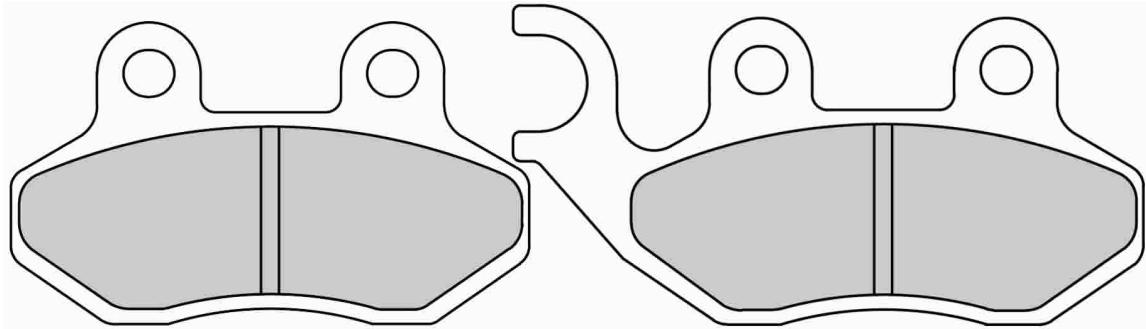

CROSS REFERENCE	
BRAKING	796
BREMBO	07005
BREMBO	7005
BRENTA	3099
BRENTA	4099
EBC	FA264
EBC	SFA264
GALFER	FD188
GOLD FREN	174
LUCAS/TRW	MCB684
NEWFREN	FD0219
SBS	140
SBS	708
VESRAH	VD-9012

		CC	KW	FROM	TO	FRONT REAR	LEFT RIGHT		
	ADIVA	S	AD 125	125		2009	2011	F	
		S	AR 125	125		2010	2011	F	
		S	AD 200	200		2009	2011	F	
		S	AR 200	200		2010	2011	F	
AKT	M	AK 125 Dynamic	125					F	
	M	AK 125 PRO	125					F	
CAGIVA	M	CITY 50	50			1995		F	
	M	PASSING 50	50			1995		F	
	M	STELLA 50	50			1997		F	
	M	STELLA 50	50			1997		R	
GARELLI	M	PASSING 125	125			1993	1997	F	
	M	KRS 50	50			2002		F	
	M	FREELAND 125	125			2002		F	
	M	JOKER 125	125			2002		F	
LAMBRETTA	M	FREELAND 150	150			2002		F	
	M	JOKER 150	150			2002		F	
	KSR MOTO BY GENERIC	S	Vendetta 50 (2T)	50		2012		F	
	S	LJ 50	50			2012	2013	F	
PEUGEOT	S	LT 50	50			2012	2013	F	
	S	LN 125 (4T)	125			2011	2013	F	
	S	LN 151 (4T)	150			2011	2013	F	
	S	Tweet 50 (4T/Rear Drum Model)	50			2010	2013	F	
PGO	S	Tweet 50 RS (4T/Rear Disc Model)	50			2010	2012	F	
	S	Tweet 50 Evo	50			2014		F	
	S	Tweet 50 Evo RS	50			2014		F	
	S	LXR 125 (4T)	125			2010	2012	F	
	S	Tweet 125 Evo (4T/Rear Drum Model) (LW2)	125	6		2010		F	
	S	Tweet 125 Evo RS (4T/Rear Disc Model)	125	6		2011		F	
	S	Tweet 150 (4T/Rear Drum Model)	150	8		2010	2011	F	
	S	Tweet 150 RS (4T/Rear Disc Model)	150			2011		F	
	S	LXR 200i (4T)	200			2010	2011	F	
	S	i-Dep Electric Scooter				2009		F	
SYM	S	i-Dep Electric Scooter				2009		R	
	M	BIG MAX 50 S	50			2003	2004	F	
	S	Big Max 50 (Front wave disc)	50			2007	2009	F	
	S	Big Max 50 Naked	50			2007	2009	F	

		CC	KW	FROM	TO	FRONT REAR	LEFT RIGHT		
	S	G-Max 50	50			2005	2007	F	
	S	G-Max 50 (Wave disc)	50			2008	2012	F	
	S	G-Max 50 Naked (Wave disc)	50			2009		F	
	S	Libra 50 (2T)	50			2009	2009	F	
	S	Ligero 50 (2T)	50			2008	2012	F	
	M	PMX 50	50			2000	2004	F	
	M	T-REX 50	50			1999	2004	F	
	S	Bubu 100	100			2003	2008	F	
	S	My Bubu 100	100			2003	2005	F	
	M	PMX 110	110			2000	2004	F	
	M	T-REX 110	110			1999	2004	F	
	S	Bubu 125	125			2003	2008	F	
	M	CHARGE 125 A / B	125			2001	2002	F	
	M	I-CHARGE 125	125			2003	2004	F	
	S	Libra 125 EFI (4T)	125			2009	2012	F	
	S	Ligero 125	125			2006	2008	F	
	S	Ligero 125 (4T)	125			2008	2012	F	
	M	MY BUBU 100 / 125	125			2003	2004	F	
	M	T-REX 125	125			1999	2004	F	
	S	T/Rex 125	125			1999	2007	F	
S	Tigra125 (4T/4V)	125			2012		F		
M	YOUNG BUBU 125	125			2003	2004	F		
S	Libra 150 (4T)	150			2009	2009	F		
M	T-REX 150	150			1999	2004	F		
S	TR-3 150cc (3 wheeler)	150			2003	2009	F		
SYM	S	Allo 50 (4T)	50			2011		F	
	S	Allo GT 50 (4T)	50			2013		F	
	S	Crox 50	50			2014		F	
	S	Fiddle II 50	50			2008		F	
	S	Fiddle III 50 (4T)	50			2014		F	
	M	JET 50	50			1999		F	
	S	Jet Basix 50	50			2006	2009	F	
	S	Jet Euro X 50	50			2006	2012	F	
	S	Jet Sport X 50 SR	50			2006	2013	F	
	S	Jet Sport X 50	50			2006	2013	F	
S	Jet Sport X 50 S	50			2006	2013	F		

M = MOTORCYCLE
S = SCOOTER
A = ATV
Sn = SNOWMOBILE

		CC	KW	FROM	TO	FRONT / REAR	LEFT / RIGHT
S	Jet 4 (50cc- 4T)	50		2010		F	
S	Jet 4 R (50cc- 2T)	50		2011		F	
S	Jet Evo 50 (2T)	50		2013		F	
S	Jet4 Naked (50cc/4T)	50		2013		F	
M	JUNGLE 50	50		1999	2002	F	
M	MASK 50	50		2000		F	
S	Orbit II 50 (4T)	50		2012		F	
S	Orbit II 50 Naked (4T)	50		2012		F	
S	Orbit II 50 TS (4T)	50		2012		F	
M	RED DEVIL 50	50		1999		F	
M	SUPER FANCY 50 (G5H-6/H325)	50		1996	2002	F	
S	Symphony 50 (4T/Rear drum model)	50		2009		F	
S	Symphony 50 SR (4T/Rear disc model)	50		2010		F	
S	Symphony S 50 (4T/Rear disc model)	50		2010		F	
S	Symphony 50 ST	50		2015		F	
S	Symply 50	50		2007	2008	F	
S	Symply II 50	50		2009		F	
M	JET 100	100		1999		F	
S	Allo 125 (4T)	125		2011		F	
M	ATTILA 125	125		1999	2000	F	
S	City Com 125	125		2008	2013	F	
S	Crox 125 i	125		2014		F	
S	Fiddle II 125	125	6	2009	2013	F	
S	Fiddle III 125 (4T)	125	7	2014		F	
M	HD Evo 125 (Carb & EFI Models/4T/Single Headlight)	125		2003		F	
S	HD 125 S Evo	125		2007		F	
M	HD2- 125i (4T)	125		2010		F	
S	JET 4 (125cc- 4T)	125	7	2009		F	
S	Jet 14 125 i	125		2017		F	
S	Jet 14 125 i	125		2017		R	
M	MEGALO 125	125		2000		F	
S	Orbit II/Symply 125 (4T)	125		2009		F	
S	Orbit II / Simply II 125 i	125		2012	2015	F	

		CC	KW	FROM	TO	FRONT / REAR	LEFT / RIGHT
M	SUPER DUKE 125 / 150	125		1999	2000	F	
S	Symphony 125 (4T/Rear drum) (AY12W)	125	7	2009		F	
S	Symphony 125 SR (4T/Rear disc model)	125		2010		F	
S	Symphony 125 S (4T/Rear disc model) (AY12W7)	125	7	2010		F	
S	Symphony 125 ST	125		2015		F	
S	Symphony Cargo 125 i	125		2015		F	
S	Symply 125	125		2007	2008	F	
S	Symply II 125	125		2009		F	
S	X Pro 125	125		2013		F	
S	Allo 150 (4T)	150		2011		F	
S	Fighter VI	150		2010	2015	F	
S	Jet4 (150cc/4T)	150		2013		F	
M	SUPER DUKE 150	150		1999		F	
S	Fiddle II 151	151		2010		F	
S	Symphony 151 SR (4T/Rear disc model)	151		2010		F	
S	Symphony S 151 (4T/Rear disc model)	151		2010		F	
S	Fiddle III 200i (4T)	200		2014		F	
S	HD 200 EVO Euro 2-3 / EVO 1 Euro 2-3	200		2005	2006	F	
S	HD200 S Evo	200		2007		F	
S	HD2-200i (Twin H/Lights/4T)	200		2010		F	
S	Jet 14 200 i	200		2018		F	
S	Symphony 200ST	200		2015	2018	F	
S	City Com 300 i	300		2008		F	
S	City Com 300 i	300		2008		R	
S	City Com 300 i S	300		2015		F	
S	City Com 300 i S	300		2015		R	
TGB	S 101R (50cc)	50		2004	2009	F	
S	202 Classic (50cc)	50		2003		F	
S	AkrosTec -50	50		2003	2004	F	
S	Delivery50 Scooter (Up to E/F no 609099)	50		2004	2006	F	
S	Bellavita125 i (4T)	125		2012		F	
S	Bellavita300 i (4T)	300		2012		F	

FDB2191

60.2 x 44.1 x 9.1 mm

April 2017: AG superseded by EF

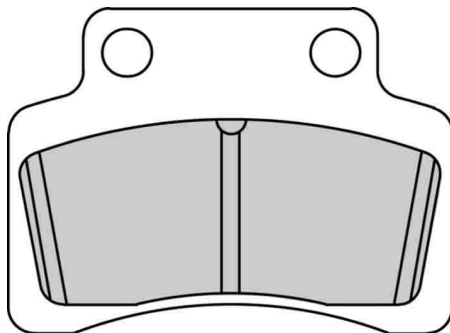

MATERIAL AVAILABILITY

AG	EF	P	PRP	ST	SM	SG	ZR	XRAC	ZRAC	CP1	CPRO
✗	✓										

CROSS REFERENCE

BREMBO	07018
BREMBO	7018
CL BRAKES	3047
EBC	FA235
EBC	SFA235
GALFER	FD175
GOLD FREN	136
LUCAS/TRW	MCB694
NEWFREN	FD0223
SBS	723
VESRAH	VD-996

		CC	KW	FROM	TO	FRONT / REAR	LEFT / RIGHT
	BENELLI	S	QuattroNove X (50cc/All Rear Drum Models)	50	2008	2012	F
		S	QuattroNove X (50cc/All Rear Disc Models)	50	2010	2012	F
		S	QuattroNove X (50cc/All Rear Disc Models)	50	2010	2012	R
	CPI	M	OLIVER 50	50	2003	2005	F
		M	POPCORN 50	50	2003		F
		M	HUSSAR 50 / 125 / 150	125	2003		F
	KEEWAY	S	F-Act 50	50	2007	2010	F
		S	F-Act-NKD 50	50	2009	2011	F
		S	F-Act 50 EVO (2T)	50	2009		F
		S	F-Act 50 EVO (4T)	50	2009		F
		S	F-Act- 50 Racing (25/45)	50	2010	2012	F
		S	F-Act- 50 RS	50	2010	2011	F
		S	Flash 50 Electric	50	2009	2010	F
		S	Focus 50	50	2006	2007	F
		S	Matrix 50 (2T)	50	2006	2012	F
		S	Matrix V4 50 (25/45)	50	2010	2011	F
		S	RY6 50cc (25/45)	50	2010		F
		S	RY8 50cc (All models)	50	2007	2009	F
		S	RY8 SP 50cc (25/45)	50	2010	2011	F
		S	RY8 Racing 50cc (25/45)	50	2010	2011	F

		CC	KW	FROM	TO	FRONT / REAR	LEFT / RIGHT	
		S	Swan 50 (25/45)	50	2010	2011	F	
		S	F-Act 125	125	2007	2011	F	
		S	Focus 125	125	2006	2007	F	
		S	Matrix 125	125	2007	2010	F	
		S	F-Act 150	150	2007	2010	F	
		S	Matrix 150	150	2007	2010	F	
	KSR MOTO BY GENERIC	S	Epico Electric			2012	2013	F
		S	Cracker 50 (2T/4T)	50		2009		F
		S	Epico 50 (2T)	50		2010		F
		S	Race 2 50 (2T/4T)	50		2010		F
		S	50 GT Race Explorer	50		2009	2009	F
		S	Roc 50	50		2008	2011	F
		S	Sirion 50 (2T/4T)	50		2012		F
		S	Toxic 50 Sport (2T)	50		2012	2012	F
		S	Race 2 125 (4T)	125		2010		F
S		Sirion 125 (4T)	125		2012		F	
KYMCO	M	HEROISM 50	50		1995	1997	F	
	M	HEROISM 125	125		1995	1997	F	
	M	HEROISM 150	150		1995	1997	F	
PEUGEOT	S	E-Vivacity (Electric)			2010		F	

FDB2192

52.0 x 36.8 x 8.2 mm

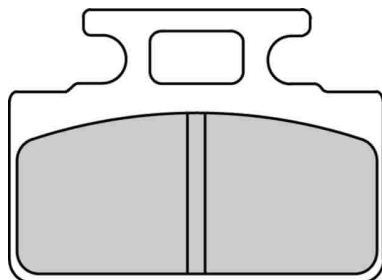



MATERIAL AVAILABILITY

AG	EF	P	PRP	ST	SM	SG	ZR	XRAC	ZRAC	CP1	CPRO
✓											

CROSS REFERENCE

BREMBO	07031
BREMBO	7031
CL BRAKES	2287
CL BRAKES	3009
EBC	FA151
GALFER	FD113
LUCAS/TRW	MCB589
NEWFREN	FD0139
SBS	618
VESRAH	VD-150

		CC	KW	FROM	TO	FRONT / REAR	LEFT / RIGHT
	HONDA	S	NH 50 LEAD	50	1988	1992	F
		S	NH 80 LEAD	80	1988		F
		M	RS 125 R	125	1991	1994	R
		M	RS 250	250	1993	1994	R
KYMCO	M	MANBOY 50	50	1995		F	
	M	SP 90 YUP	90	1995		F	
SYM	S	E Woo - Electric		2011		F	
	S	E-Symmetry(Electric)		2012	2013	F	
	S	E-ViridDeluxe (Electric)		2012		F	

		CC	KW	FROM	TO	FRONT / REAR	LEFT / RIGHT
	M	BULLET 50	50	1993		F	
	M	FEEL BIG 50	50	1998	2002	F	
	S	Mio 50	50	2005	2013	F	
	M	PURE 50	50	1998	2002	F	
	S	Tonic 50	50	2011		F	
	S	Mio 100	100	2005	2014	F	
	S	Mio 110i	110	2005	2015	F	
	S	Tonic 110 (4T)	110	2011	2013	F	
	S	Tonic 125	125	2011		F	

M = MOTORCYCLE
S = SCOOTER
A = ATV
Sn = SNOWMOBILE

FDB2193

65.8 x 44.7 x 11.4 mm

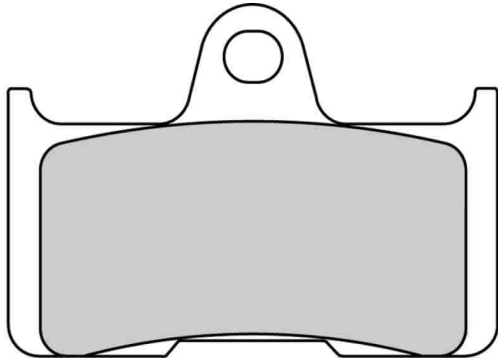

MATERIAL AVAILABILITY											
AG	EF	P	PRP	ST	SM	SG	ZR	XRAC	ZRAC	CP1	CPRO
						✓					

CROSS REFERENCE	
BREMBO	07YA45
EBC	FA344
LUCAS/TRW	MCB756
NEWFREN	FD0388
SBS	799
VESRAH	VD-270

		CC	KW	FROM	TO	FRONT / REAR	LEFT / RIGHT
CFMOTO	A CF 500-5 (Rancher 500 UTV)	500		2010	2012	R	
	A CF 500 (Terracross)	500		2011	2012	R	
	A CF 500 CForce (5B/5C Classic Parking Brake)	500		2014	2015	R	
	A CF 625-3 (Z6 Terracross)	625		2011	2012	R	
	A CF 625 - B/C (X6 Terranlander)	625		2011	2012	R	
	A CF 800-2 CForce (Terranlander)	800		2012		R	
QUADZILLA	A CUV 500 Side X Side	500		2010	2011	R	

		CC	KW	FROM	TO	FRONT / REAR	LEFT / RIGHT
	A QZ 500 E/ES 4x4	500		2009	2011	R	
	A RL 500 MK 11 Buggie	500		2010	2011	R	
	A RS 5 4WD	500		2010	2011	R	
	A Z6 4X4	600		2010	2013	R	
YAMAHA ATV	A YFM 660 GRIZZLY	660		2002	2008	R	
	A YFM 660 Ducks Unlimited Ed.-side by side	660		2006	2007	R	

FDB2194

48.1 x 44.6 x 7.1 mm

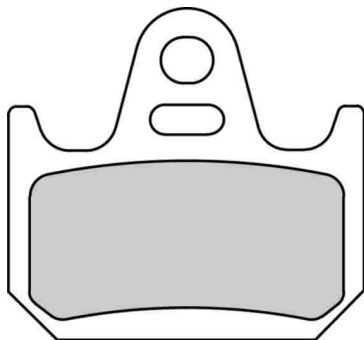

MATERIAL AVAILABILITY											
AG	EF	P	PRP	ST	SM	SG	ZR	XRAC	ZRAC	CP1	CPRO
		!									

Pinze / Calipers

Nissin

Nissin 2pot rear (TZ250, others)

CROSS REFERENCE	
CL BRAKES	2269
EBC	FA162
GALFER	FD163
LUCAS/TRW	MCB646
NEWFREN	FD0395
SBS	659
VESRAH	VD-253

		CC	KW	FROM	TO	FRONT / RÉAR	LEFT / RIGHT
YAMAHA	M TZ 125	125		1997		R	
	M TZ 250	250		1989	2001	R	

		CC	KW	FROM	TO	FRONT / RÉAR	LEFT / RIGHT
M	TZ 250	250		2002	2008	R	
	TZR 250 R	250		1994		R	

FDB2195

82.0 x 38.7 x 10.2 mm

MATERIAL AVAILABILITY											
AG	EF	P	PRP	ST	SM	SG	ZR	XRAC	ZRAC	CP1	CPR0
						✓					

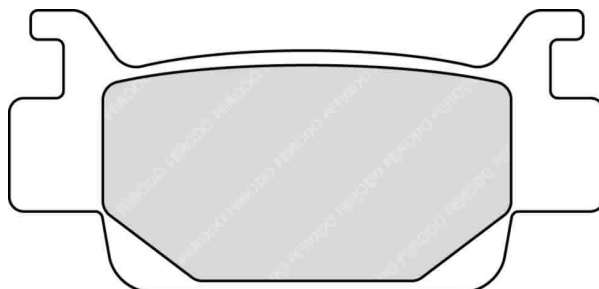

CROSS REFERENCE	
BREMBO	07HO58
EBC	FA410
LUCAS/TRW	MCB823
NEWFREN	FD0397
VESRAH	VD-175

		CC	KW	FROM	TO	FRONT / RÉAR	LEFT / RIGHT
HONDA ATV	A TRX 500 TM/FE/FA/FMA/FPE/FPM Fourtrax Foreman	500		2005	2010	F	
	A TRX 500 FA/FAA Fourtrax Foreman Rubicon	500		2005	2010	F	
	A TRX 500 FGA Fourtrax Foreman Rubicon Gpscape	500		2005	2009	F	
	A TRX 500 FPA9 Fourtrax Foreman Rub.Gpscape EPS	500		2009		F	

		CC	KW	FROM	TO	FRONT / RÉAR	LEFT / RIGHT
A	TRX 680 Fourtrax Rincon Gpscape	680		2006	2009	F	
	TRX 680 Fourtrax Rincon	680		2006	2010	F	
	TRX 700 XX (8/XX9)	700		2008	2009	R	

M = MOTORCYCLE
S = SCOOTER
A = ATV
Sn = SNOWMOBILE

FDB2196

118.1 x 45.4 x 8.4 mm

September 2016: AG superseded by EF

MATERIAL AVAILABILITY											
AG	EF	P	PRP	ST	SM	SG	ZR	XRAC	ZRAC	CP1	CPRO
✗	✓	✓		✓	✓						

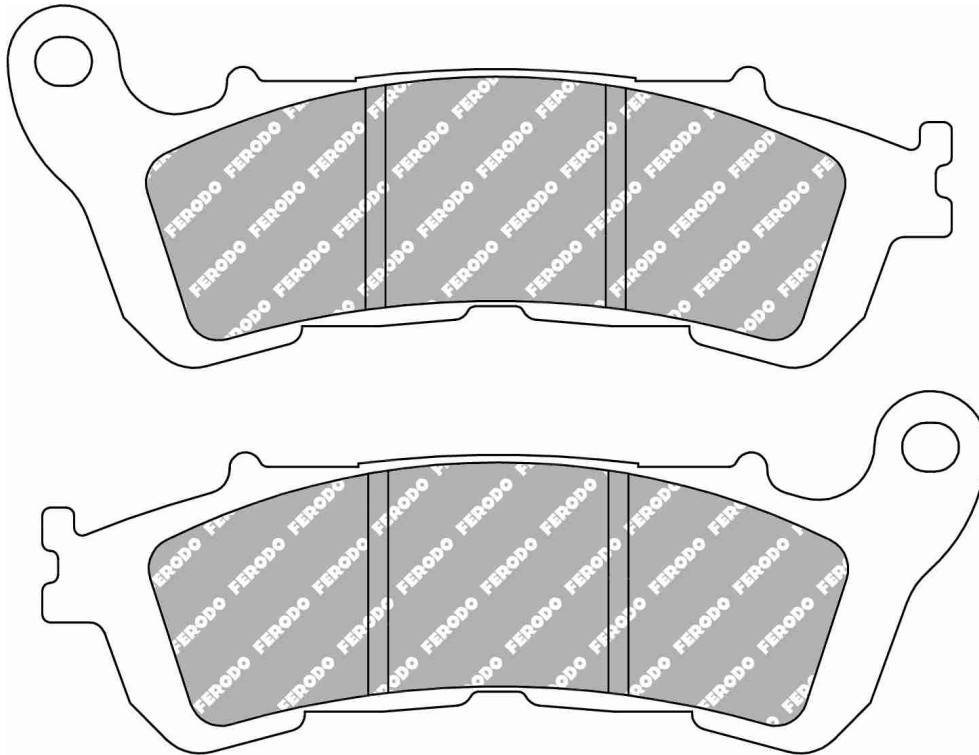

CROSS REFERENCE	
BRAKING	910
BREMBO	07063
BREMBO	07HD22
BREMBO	07HO57
BREMBO	7063
BRENTA	3081
BRENTA	4081
CL BRAKES	1159
CL BRAKES	3082
EBC	FA388
GALFER	FD344
GOLD FREN	257
LUCAS/TRW	MCB776
NEWFREN	FD0385
SBS	192
SBS	828
VESRAH	VD-172

		CC	KW	FROM	TO	FRONT / REAR	LEFT / RIGHT
	M FES 125 S-WING	125		2007		F	
	M SH 125i (JF23)	125	10	2008	2012	F	
	M FES 150 S-WING	150		2007	2013	F	
	M SH 150i (KF10)	150	12	2009	2012	F	
	M CBR 250 R ABS	250		2011		F	
	S NSS 250 FORZA EX (ABS)	250		2005	2008	F	
	S NSS 250 FORZA Z (ABS)	250		2005	2006	F	
	S NSS 250 FORZA Z (ABS)	250		2005	2006	R	
	S NSS 250 FORZA X	250		2005	2008	F	
	S NSS 300 FORZA (NF04)	300	18	2013		F	
	M SH 300i (NF02)	300	20	2007	2014	F	
	S Silver Wing GT400 (FJS400D)	400		2009	2017	F	
	S Silver Wing GT400 ABS (FJS400A)	400		2009	2017	F	
	S SW-T 400	400		2009		F	
	M CBF 500 ABS	500		2004	2007	F	

		CC	KW	FROM	TO	FRONT / REAR	LEFT / RIGHT
	M CB 600 F HORNET ABS	600		2007		F	
	M CBF 600 N / S / ABS	600		2008		F	
	S Silver Wing 600 (FJS600D)	600		2009	2010	F	
	S Silver Wing GT ABS (FJS600A)	600		2009	2017	F	
	S SW-T 600 ABS	600		2011		F	
	M DEAUVILLE TRAVEL	680		2007		F	
	M DN-01 Sports Cruiser	680		2009		F	
	M NT 700 DEAUVILLE 680 / ABS	680		2006		F	
	M XL 700 V TRANSALP (ABS)	680	44	2007		F	
	M NC 700 D Integra (RC62)	700	35	2012	2013	F	
	M NC 700 D Integra (RC62)	700	38	2012	2013	F	
	M NC 700 SA, XA (man.gearbox - ABS)	700		2012		F	
	M NC 700 SD, XD (automatic gearbox - ABS)	700		2012		F	
	M VT 750 C2 SHADOW	750		2010	2012	F	
	M VFR 800 X Crossrunner (RC60)	780		2011	2013	F	

		CC	KW	FROM	TO	FRONT / REAR	LEFT / RIGHT
	M VFR 800	800		2006	2013	F	
	M VFR 800 XC Crossrunner	800		2012	2014	F	
	M CBF 1000 / Special Ed. (ABS System)	1000		2006		F	
	M CBF 1000 / Special Ed. (ABS System)	1000		2006		R	
	M CBF 1000 F ABS	1000		2011		F	
	M XL 1000 VARADERO A4 (ABS)	1000		2004		F	
	M CB 1100	1100		2013		F	
	M VFR 1200 XA Crosstourer (Man.Tras.) SC70	1237	95	2012		F	
	M VFR 1200 XD-DCT Crosstourer (Autom. Transm.) SC70	1237	95	2012		F	
	M VFR 1200 X Crosstourer	1237		2016		F	

		CC	KW	FROM	TO	FRONT / REAR	LEFT / RIGHT
	M CB 1300 S	1300		2011		F	
	M CTX1300	1300		2014		F	
	M ST 1300 PAN EUROPEAN / ABS	1300		2008		F	
SUZUKI	S SIXTEEN 125 UH	125		2008		F	
	S UH 125 BURGMAN	125		2007	2013	F	
	S SIXTEEN 150 UH	150		2008		F	
	S UH 150 BURGMAN	150	11	2007	2013	F	
	S UH 200 BURGMAN	200		2007	2013	F	
	M VLR 1800 INTRUDER C1800 R/RT	1800		2008		F	

FDB2197

75.7 x 41.5 x 8.2 mm / 99.2 x 40.2 x 7.5 mm

MATERIAL AVAILABILITY

AG	EF	P	PRP	ST	SM	SG	ZR	XRAC	ZRAC	CP1	CPRO
						✓					

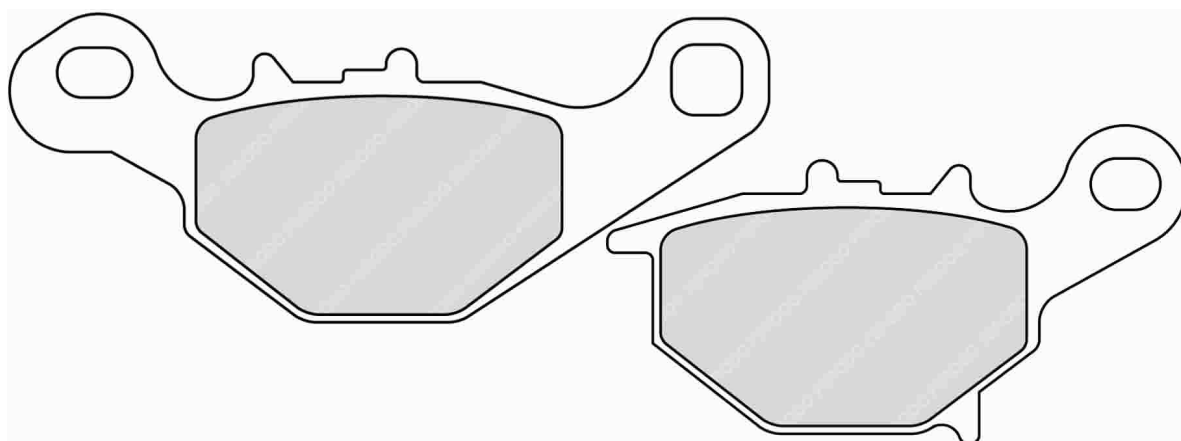

ALSO AVAILABLE

SHAPE	TH. MM	NOTES
FDB2133		Coupled set

CROSS REFERENCE

BRAKING	905
BREMBO	07SU31
CL BRAKES	1152
EBC	FA401
NEWFREN	FD0399
SBS	820
VESRAH	VD-358

		CC	KW	FROM	TO	FRONT / REAR	LEFT / RIGHT
	SUZUKI	M	RM 85 L	85		2005	R

M = MOTORCYCLE
S = SCOOTER
A = ATV
Sn = SNOWMOBILE

FERODO
RACING
Updated on November 2020

4267

FDB2198

69.9 x 42.9 x 7.4 mm

MATERIAL AVAILABILITY

AG	EF	P	PRP	ST	SM	SG	ZR	XRAC	ZRAC	CP1	CPRO
				✓							

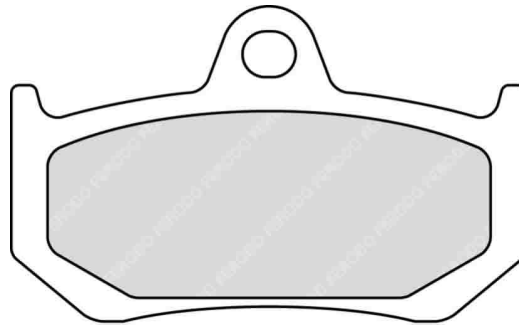

CROSS REFERENCE

BRAKING	907
BREMBO	07GR35
EBC	FA320
LUCAS/TRW	MCB797
NEWFREN	FD0391
SBS	763
VESRAH	VD-998

		CC	KW	FROM	TO	FRONT / REAR	LEFT / RIGHT
	M BRUTALE 750 F4	750		2003	2005	R	
	M BRUTALE 910 R	910		2006	2008	R	
	M BRUTALE 910 S	910		2007		R	
	M BRUTALE 920 (B53)	920		2011	2012	R	
	M BRUTALE 989 R	989		2008	2009	R	
	M BRUTALE 990 R	990		2010	2011	R	
	M F4 1000	998		2004	2006	R	
	M F4 1000 R	998		2006	2007	R	
	M F4 1000 312R (Up to VIN #008064)	998		2007	2007	R	
	M F4 1000 312R 1+1	998		2007	2008	R	
	M F4 1000 VELTRO	998		2008	2008	R	
	M F4 1000 312R (From VIN #008065)	998		2008	2009	R	
	M F4 1000 S Freccie Tricolori	998		2010	2010	R	
	M F4 1000	998		2010	2015	R	

		CC	KW	FROM	TO	FRONT / REAR	LEFT / RIGHT
	M F4 1000 R	998		2012		R	
	M F4 1000 RR	998	148	2012		R	
	M F4 1000 RC	998	151	2015		R	
	M F4 1000 LH44	998	151	2018		R	
	M F4 1000 RC Lim.ed.	998	156	2018		R	
	M F4 1000 Claudio	998		2019		R	
	M BRUTALE 1078 RR	1078		2008	2009	R	
	M F4 1078 312 RR	1078		2007	2008	R	
	M F4 100 CC	1078		2007	2008	R	
	M F4 1078 RR	1078		2008	2011	R	
	M BRUTALE 1090 RR	1090		2010		R	
	M BRUTALE 1090 R	1090		2012		R	
	M BRUTALE 1090	1090		2013		R	

FDB2200

100.1 x 38.3 x 12.0 mm

MATERIAL AVAILABILITY											
AG	EF	P	PRP	ST	SM	SG	ZR	XRAC	ZRAC	CP1	CPRO
	✓	✓			✓						

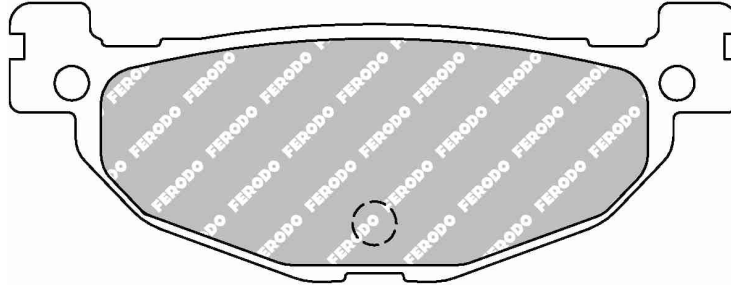

CROSS REFERENCE	
BRAKING	904
BREMBO	07059
BREMBO	7059
BRENTA	3078
BRENTA	4078
CL BRAKES	3061
CL BRAKES	3075
EBC	FA408
EBC	SFA408
GALFER	FD352
GOLD FREN	268
NEWFREN	FD0378
SBS	185
SBS	812
VESRAH	VD-275

		CC	KW	FROM	TO	FRONT / RÉAR	LEFT / RIGHT	
	MBK	S	SKYLINER 400	400		2004	R	
	YAMAHA	S	CP 250 (1B71) Maxam/Morphus	250		2005	2008	R
		S	YP 400 MAJESTY	400		2004	2004	R
		S	YP 400 MAJESTY (NO ABS)	400		2005		R
		S	YP 400 MAJESTY (ABS)	400		2007		R

		CC	KW	FROM	TO	FRONT / RÉAR	LEFT / RIGHT
	S	TMAX 500 (SJ03)	500	33	2004	2007	R
	S	TMAX 500 (SJ05)	500	32	2008	2011	R
	S	TMAX 500 SV (Tech Max)	500		2011		R
	S	TMAX 500 SV ABS (Tech Max)	500		2011		R

M = MOTORCYCLE
S = SCOOTER
A = ATV
Sn = SNOWMOBILE

FDB2201

70.0 x 51.7 x 7.5 mm

MATERIAL AVAILABILITY											
AG	EF	P	PRP	ST	SM	SG	ZR	XRAC	ZRAC	CP1	CPRO
				✓							

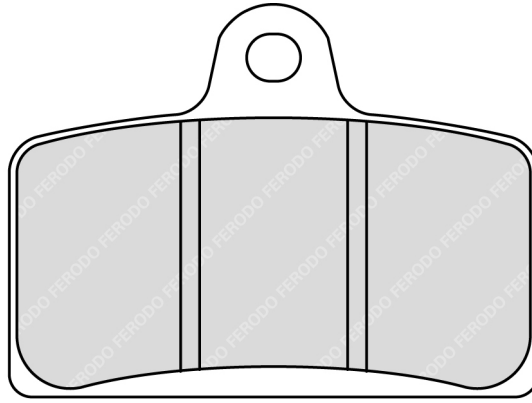

CROSS REFERENCE	
BRAKING	964
BREMBO	07GR72
BRENTA	3142
BRENTA	4142
EBC	FA399
GALFER	FD341
GOLD FREN	233
LUCAS/TRW	MCB780
NEWFREN	FD0380
SBS	821
VESRAH	VD-9004

		CC	KW	FROM	TO	FRONT / REAR	LEFT / RIGHT
 APRILIA	M	RS4 50 (AJP caliper)	50	2011		F	
	M	RS4 50 (JJ caliper)	50	2011		F	
	M	RS	125	2017		F	
	M	RS4 125 4T (AJP caliper)	125	2011		F	
	M	RS4 125 4T (JJ caliper)	125	2011		F	
M	RS4 125 4T SBK Replica (JJ caliper)	125		2015		F	

		CC	KW	FROM	TO	FRONT / REAR	LEFT / RIGHT
 DERBI	M	TUONO 125 4T	125		2017		F
	M	GPR 50	50		2010		F
	M	GPR 125 / NUDE (Radial Caliper)	125		2004	2009	F
	M	GPR 125	125		2010		F
PEUGEOT	S	NK7 (50cc) Naked	50		2009	2012	F
	S	XR7 (50cc) Full Fairing	50		2008	2012	F

FDB2202

98.1 x 64.2 x 8.1 mm

MATERIAL AVAILABILITY

AG	EF	P	PRP	ST	SM	SG	ZR	XRAC	ZRAC	CP1	CPRO
		✓		✓							

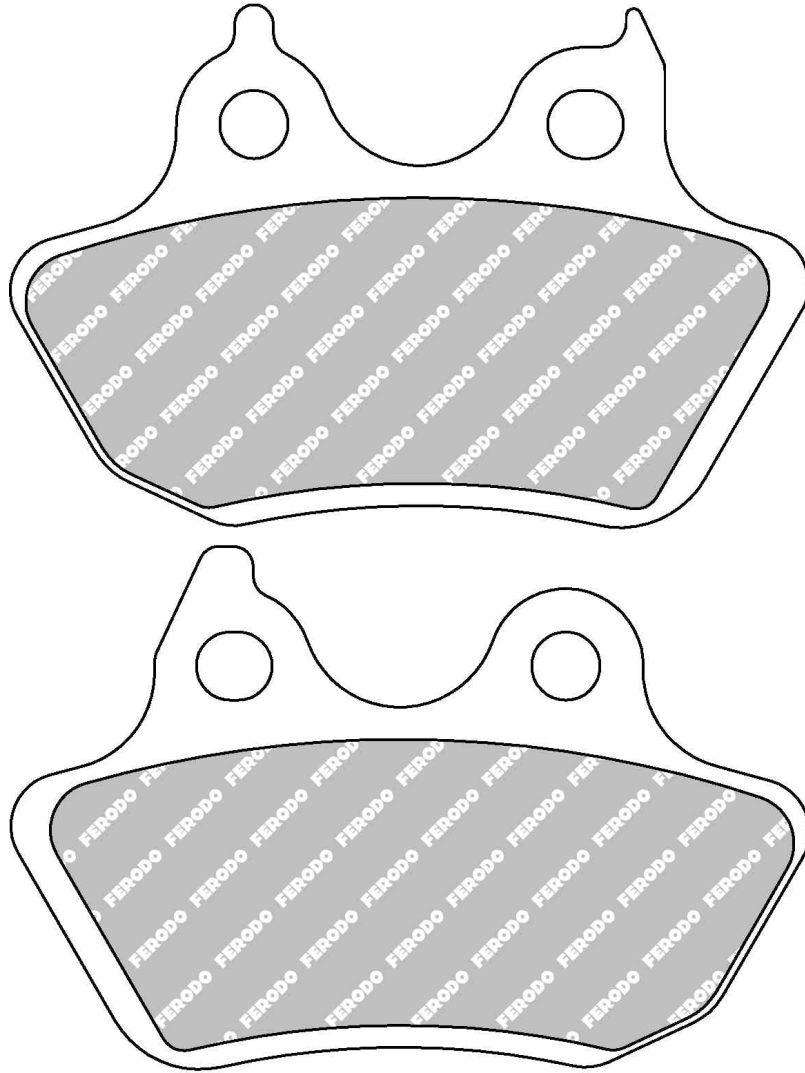

CROSS REFERENCE

BRAKING	951
BREMBO	07HD18
BRENTA	4164
EBC	FA434
NEWFREN	FD0389
NEWFREN	FD0416
SBS	846
VESRAH	VD-9022
VESRAH	VD-971

		CC	KW	FROM	TO	FRONT / REAR	LEFT / RIGHT
 HARLEY DAVIDSON	M FXSTD/I Softail Deuce	1450		2006		R	
	M FXSTS/FXSTSi Softail Springer	1450		2006		R	
	S FLSTC Heritage Softail Classic	1584		2007	2007	R	
	M FLSTF Fat Boy	1584		2007	2007	R	
	M FLSTSC/FLSTSCi Springer Softail Classic	1584		2006	2007	R	

		CC	KW	FROM	TO	FRONT / REAR	LEFT / RIGHT
	M FXST/FXSTi Softail Standard	1584		2006	2007	R	
	M FXSTB/FXSTBi Night Train Softail	1584		2006	2007	R	
	M FXSTC Softail Custom	1584		2007		R	
	M FXSTD Softail Deuce	1584		2007		R	

M = MOTORCYCLE
S = SCOOTER
A = ATV
Sn = SNOWMOBILE

FDB2204

71.7 x 50.3 x 9.3 mm

For OEM numbers see FDB2178

MATERIAL AVAILABILITY											
AG	EF	P	PRP	ST	SM	SG	ZR	XRAC	ZRAC	CP1	CPRO
								✓	✓	✓	

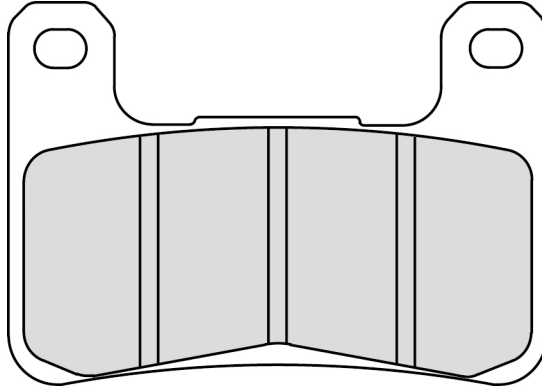

ALSO AVAILABLE		
SHAPE	TH. MM	NOTES
FDB2178	7.8	

CROSS REFERENCE	
GOLD FREN	213
NEWFREN	FD0409
SBS	806

		CC	KW	FROM	TO	FRONT / REAR	LEFT / RIGHT
 SUZUKI	M	GSX-R 600 - Racing Applications	600	2004	2005	F	
	M	GSX-R 600 - Racing Applications	600	2006		F	
	M	GSX-R 750 - Racing Applications	750	2004	2005	F	

		CC	KW	FROM	TO	FRONT / REAR	LEFT / RIGHT
 SUZUKI	M	GSX-R 750 - Racing Applications	750		2006		F
	M	GSX-R 1000 - Racing Applications	1000	2004	2008	F	
	M	GSX-R 1000 - Racing Applications	1000		2009		F

FDB2205

74.6 x 47.4 x 9.0 mm

For OEM numbers see FDB2181; CP1 superseded by CPRO

MATERIAL AVAILABILITY											
AG	EF	P	PRP	ST	SM	SG	ZR	XRAC	ZRAC	CP1	CPRO
								✗	✓	✗	✓

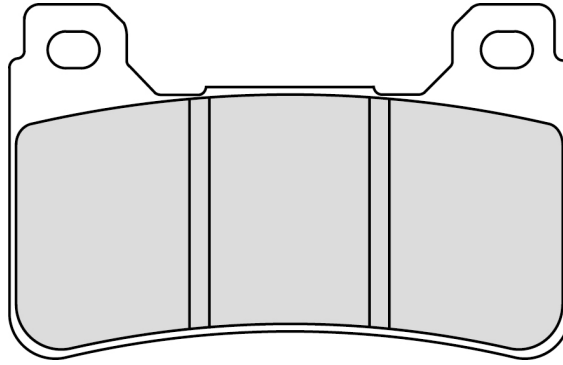

ALSO AVAILABLE		
SHAPE	TH. MM	NOTES
FDB2181	8.0	

CROSS REFERENCE	
GOLD FREN	214
NEWFREN	FD0410
SBS	809

		CC	KW	FROM	TO	FRONT / REAR	LEFT / RIGHT		
	HONDA	M	CBR 600 RR (Racing spec.)	600		2005	2005	F	

		CC	KW	FROM	TO	FRONT / REAR	LEFT / RIGHT		
	M	CBR 1000 FIREBLADE - Racing Applications	1000			2004	2005	F	

FDB2206

66.2 x 37.2 x 7.6 mm

MATERIAL AVAILABILITY											
AG	EF	P	PRP	ST	SM	SG	ZR	XRAC	ZRAC	CP1	CPRO
		✓									

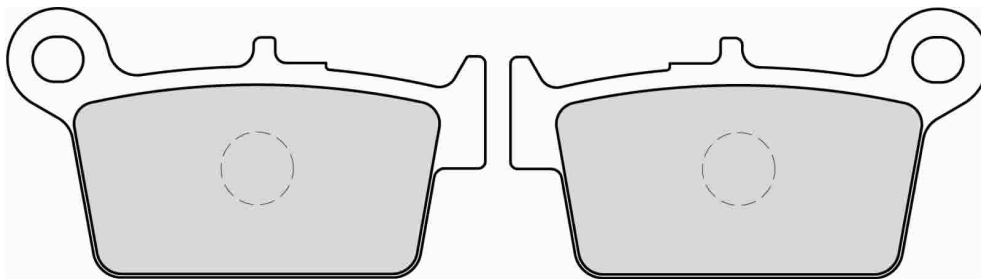

CROSS REFERENCE	
BREMBO	07.GR05
BRENTA	3125
BRENTA	4125
EBC	FA367/2
LUCAS/TRW	MCB820
NEWFREN	FD0398
SBS	199
SBS	861

M = MOTORCYCLE
S = SCOOTER
A = ATV
Sn = SNOWMOBILE

		CC	KW	FROM	TO	FRONT / REAR	LEFT / RIGHT
	BETA	M	RR 50 Enduro	50	2004	2007	R
		M	RR 50 Motard (Spoke Wheel)	50	2009	2012	R
		M	ALP 125 4T	125	2005	2012	R
		M	Urban 125	125	2008	2012	R

		CC	KW	FROM	TO	FRONT / REAR	LEFT / RIGHT
	M	ALP 200 4T	200	2005	2012	R	
	M	URBAN 200	200	2008	2012	R	
	M	ALP 4.0 350 4T	350	2005	2012	R	
	M	M4 Supermotard	350	2006	2012	R	

FDB2207

55.7 x 54.5 x 8.0 mm

July 2017: AG superseded by EF

MATERIAL AVAILABILITY											
AG	EF	P	PRP	ST	SM	SG	ZR	XRAC	ZRAC	CP1	CPRO
✗	✓										

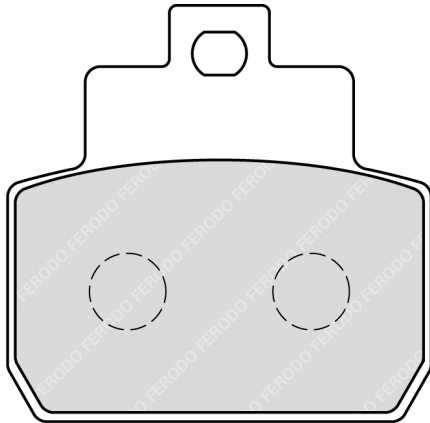

CROSS REFERENCE	
BRAKING	909
BREMBO	07061
BREMBO	7061
BRENTA	3079
BRENTA	4079
EBC	FA425
EBC	SFA425
GALFER	FD343
GOLD FREN	263
LUCAS/TRW	MCB782
NEWFREN	FD0394

		CC	KW	FROM	TO	FRONT / REAR	LEFT / RIGHT
	PIAGGIO	S	MP3 125 ie	125	2006		R
		M	X8 125	125	2005		R
		S	X8 125 ie	125	2007		R
		S	MP3 250	250	2007		R
		M	X9 250 Evolution	250	2005		R

		CC	KW	FROM	TO	FRONT / REAR	LEFT / RIGHT
	M	X8 250	250	2006			R
	S	X8 250 ie	250	2007			R
	S	MP3 LT 400 ie	400	2009			R
	M	BEVERLY 500	500	2006	2006		R

FDB2208

94.0 x 40.0 x 7.6 mm

August 2016: AG superseded by EF

MATERIAL AVAILABILITY											
AG	EF	P	PRP	ST	SM	SG	ZR	XRAC	ZRAC	CP1	CPRO
✘	✔										

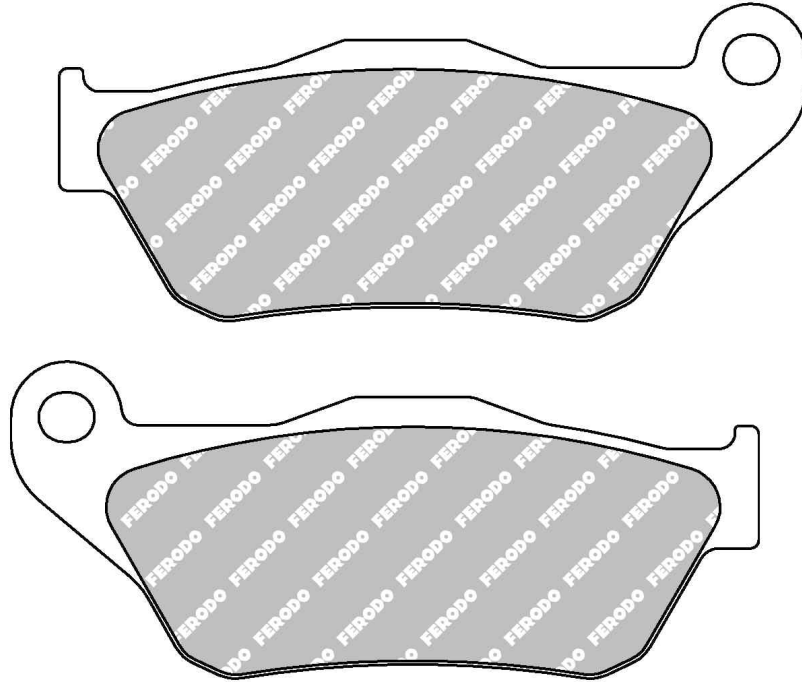

CROSS REFERENCE	
BRAKING	926
BREMBO	07065
BREMBO	7065
BRENTA	3080
BRENTA	4080
EBC	SFA430
GALFER	FD355
GOLD FREN	262
LUCAS/TRW	MCB786
NEWFREN	FD0396
SBS	194

		CC	KW	FROM	TO	FRONT REAR	LEFT RIGHT
 YAMAHA	M	YP 125 MAJESTY	125		2015	F	
	M	YP 125 R X-MAX (Brembo Front) NO ABS	125		2006	2009	F
	M	CELLOW 225	225		2005		F

		CC	KW	FROM	TO	FRONT REAR	LEFT RIGHT
 M	M	X-Max 250 (SG16) - No ABS	250	15	2005	2009	F
	M	X-Max 250 (SG16) - No ABS	250	16	2007	2009	F

M = MOTORCYCLE
S = SCOOTER
A = ATV
Sn = SNOWMOBILE

FDB2209

86.4 x 42.0 x 9.8 mm

MATERIAL AVAILABILITY											
AG	EF	P	PRP	ST	SM	SG	ZR	XRAC	ZRAC	CP1	CPRO
								!			

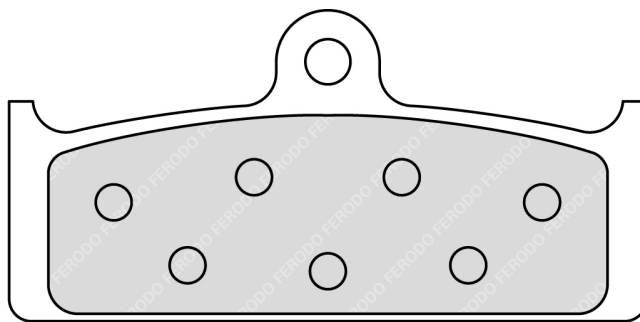

Pinze / Calipers

Nissin

Nissin 4Pot Radial Mount/billet

CROSS REFERENCE	
NEWFREN	FD0403

FDB2210

92.1 x 58.6 x 7.0 mm

MATERIAL AVAILABILITY											
AG	EF	P	PRP	ST	SM	SG	ZR	XRAC	ZRAC	CP1	CPRO
		✓		✓							

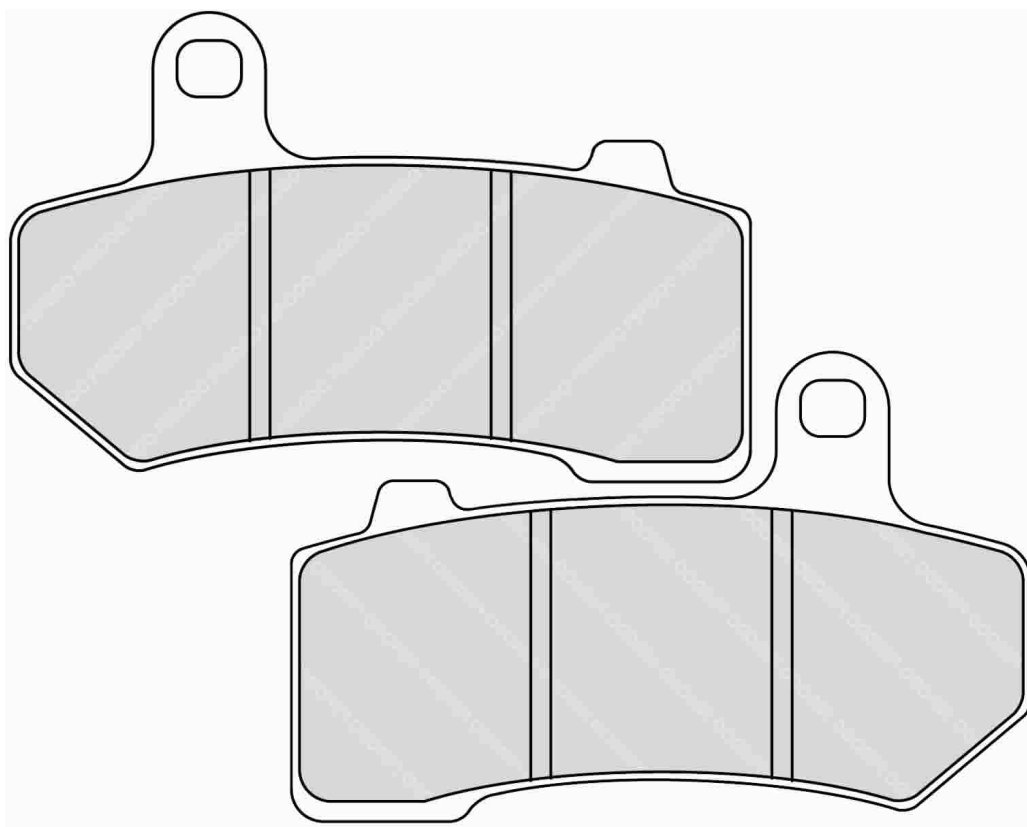

CROSS REFERENCE	
BREMBO	07.92.8720
BRENTA	4171
CL BRAKES	1172
DP (Dunlop) BRAKE	DP962
EBC	FA409
LUCAS/TRW	MCB781
NEWFREN	FD0405
SBS	830
VESRAH	VD-9025



		CC	KW	FROM	TO	FRONT / REAR	LEFT / RIGHT
HARLEY DAVIDSON	M VRSCD Night Rod (Cast Wheel)	1130		2006		F	
	M VRSCD Night Rod (Cast Wheel)	1130		2006		R	
	M VRSCR Street Rod	1130		2006		F	
	M VRSCR Street Rod	1130		2006		R	
	M VRSC V-Rod	1130		2006	2008	F	
	M VRSC V-Rod	1130		2006	2008	R	
	M VRSCAW V-Rod	1250		2007	2008	F	
	M VRSCAW V-Rod	1250		2007	2008	R	
	M VRSCDX Night Rod Special (Cast Wheel)	1250		2008		F	
	M VRSCDX Night Rod Special (Cast Wheel)	1250		2008		R	
	M VRSCF V-Rod Muscle	1250		2008		F	
	M VRSCF V-Rod Muscle	1250		2008		R	
	M VRSCAW V-Rod (Spoke wheel)	1250		2008		F	
	M VRSCAW V-Rod (Spoke wheel)	1250		2008		R	
	M VRSCX V-Rod	1250		2008		F	
	M VRSCX V-Rod	1250		2008		R	
	M FLHR Road King	1584		2007	2011	F	
	M FLHR Road King	1584		2007	2011	R	
	M FLHRC Road King Classic	1584		2007	2011	F	
	M FLHRC Road King Classic	1584		2007	2011	R	
	M FLHR Road King Shrine	1584		2008	2011	F	
	M FLHR Road King Shrine	1584		2008	2011	R	
	M FLHT Electra Glide Standard	1584		2008	2010	F	
	M FLHT Electra Glide Standard	1584		2008	2010	R	
	M FLHTC Electra Glide Classic	1584		2008	2011	F	
	M FLHTC Electra Glide Classic	1584		2008	2011	R	
	M FLHTCU Ultra Classic Electra Glide	1584		2008	2011	F	
	M FLHTCU Ultra Classic Electra Glide	1584		2008	2011	R	
	M FLHTCU Ultra Classic Electra Glide Shrine	1584		2008	2011	F	
	M FLHTCU Ultra Classic Electra Glide Shrine	1584		2008	2011	R	
	M FLHX Street Glide	1584		2008	2011	F	
	M FLHX Street Glide	1584		2008	2011	R	
	M FLTR Road Glide	1584		2007	2009	F	
	M FLTR Road Glide	1584		2007	2009	R	
	M FLTRX Road Glide Custom	1584		2010	2011	F	
	M FLTRX Road Glide Custom	1584		2010	2011	R	
	M FLHR Road King	1690		2011		F	
	M FLHR Road King	1690		2011		R	
	M FLHRC Road King Classic	1690		2011		F	
	M FLHRC Road King Classic	1690		2011		R	
	M FLHR Road King Shrine	1690		2012	2013	F	
	M FLHR Road King Shrine	1690		2012	2013	R	
	M FLHR ANV Road King 110th Ann. Ed.	1690		2013	2013	F	
	M FLHR ANV Road King 110th Ann. Ed.	1690		2013	2013	R	
	M FLHR CVO Road King	1690		2014	2014	F	
	M FLHR CVO Road King	1690		2014	2014	R	
	M FLHTCUTG Ultra Classic Tri Glide	1690		2009	2014	F	
	M FLHTCU Ultra Classic Electra Glide	1690		2012		F	
	M FLHTCU Ultra Classic Electra Glide	1690		2012		R	
	M FLHTC Electra Glide Classic	1690		2012	2013	F	
	M FLHTC Electra Glide Classic	1690		2012	2013	R	
	M FLHTCU Ultra Classic Electra Glide Shrine	1690		2012	2013	F	
	M FLHTCU Ultra Classic Electra Glide Shrine	1690		2012	2013	R	
	M FLHTCUSE8 CVO Ultra Classic Electra Glide	1690		2013	2013	F	
	M FLHTCUSE8 CVO Ultra Classic Electra Glide	1690		2013	2013	R	
	M FLHTCU TC Ultra Classic Electra Glide	1690		2014		F	
	M FLHTCU TC Ultra Classic Electra Glide	1690		2014		R	
	M FLHTCUL Ultra Classic Electra Glide Low	1690		2015		F	
	M FLHTCUL Ultra Classic Electra Glide Low	1690		2015		R	
	M FLHTCUL TC Ultra Classic Electra Glide Low	1690		2015		F	
	M FLHTCUL TC Ultra Classic Electra Glide Low	1690		2015		R	
	M FLHTK Electra Glide Ultra LTD	1690		2010		F	
	M FLHTK Electra Glide Ultra LTD	1690		2010		R	
	M FLHTK ANV Electra Glide Ultra LTD 110th Ann. Ed.	1690		2013	2013	F	
	M FLHTK ANV Electra Glide Ultra LTD 110th Ann. Ed.	1690		2013	2013	R	
	M FLHTK CVO Electra Glide Ultra LTD	1690		2014	2014	F	
	M FLHTK CVO Electra Glide Ultra LTD	1690		2014	2014	R	
	M FLHTK Electra Glide Ultra LTD Shrine	1690		2015	2016	F	



		CC	KW	FROM	TO	FRONT / REAR	LEFT / RIGHT
	M FLHTK Electra Glide Ultra LTD Shrine	1690		2015	2016	R	
	M FLHTKL Electra Glide Ultra LTD Low	1690		2015		F	
	M FLHTKL Electra Glide Ultra LTD Low	1690		2015		R	
	M FLHXXX Street Glide Trike	1690		2010	2011	F	
	M FLHX Street Glide	1690		2011		F	
	M FLHX Street Glide	1690		2011		R	
	M FLHXS Street Glide Special	1690		2014		F	
	M FLHXS Street Glide Special	1690		2014		R	
	M FLTRU Road Glide Ultra	1690		2011	2013	F	
	M FLTRU Road Glide Ultra	1690		2011	2013	R	
	M FLTRX Road Glide Custom	1690		2011		F	
	M FLTRX Road Glide Custom	1690		2011		R	
	M FLTRXS Road Glide Special	1690		2015		F	
	M FLTRXS Road Glide Special	1690		2015		R	
	M FLTRU Road Glide Ultra	1690		2016		F	
	M FLTRU Road Glide Ultra	1690		2016		R	
	M FLHR Road King	1745		2018		F	
	M FLHR Road King	1745		2018		R	
	M FLHRC Road King Classic	1745		2018		F	
	M FLHRC Road King Classic	1745		2018		R	
	M FLHRXS Road King Special	1745		2018		F	
	M FLHTK Electra Glide Ultra LTD	1745		2018		F	
	M FLHTK Electra Glide Ultra LTD	1745		2018		R	
	M FLHTKL Electra Glide Ultra LTD Low	1745		2018		F	
	M FLHTKL Electra Glide Ultra LTD Low	1745		2018		R	
	M FLHX Street Glide	1745		2018		F	
	M FLHX Street Glide	1745		2018		R	
	M FLHXS Street Glide Special	1745		2018		F	
	M FLHXS Street Glide Special	1745		2018		R	
	M FLTRU Road Glide Ultra	1745		2018		F	
	M FLTRU Road Glide Ultra	1745		2018		R	
	M FLTRX Road Glide Custom	1745		2018		F	
	M FLTRX Road Glide Custom	1745		2018		R	
	M FLTRXS Road Glide Special	1745		2018		F	
	M FLTRXS Road Glide Special	1745		2018		R	
	M FLHTCUTG Tri Glide Ultra Classic	1745		2014		F	
	M FLHRSE CVO Road King	1802		2014	2014	F	
	M FLHRSE CVO Road King	1802		2014	2014	R	
	M FLHTCUSE4-5-6-7 CVO Ultra Classic Electra Glide	1802		2009	2012	F	
	M FLHTCUSE4-5-6-7 CVO Ultra Classic Electra Glide	1802		2009	2012	R	
	M FLHTCU8 CVO Ultra Classic Electra Glide	1802		2013	2013	F	
	M FLHTCU8 CVO Ultra Classic Electra Glide	1802		2013	2013	R	
	M FLHTKSE CVO Electra Glide Ultra LTD	1802		2014		F	
	M FLHTKSE CVO Electra Glide Ultra LTD	1802		2014		R	
	M FLHXSE-SE2-SE3 CVO Street Glide	1802		2010	2012	F	
	M FLHXSE-SE2-SE3 CVO Street Glide	1802		2010	2012	R	
	M FLTRSE3 CVO Road Glide	1802		2009	2009	F	
	M FLTRSE3 CVO Road Glide	1802		2009	2009	R	
	M FLTRUSE CVO Road Glide Ultra	1802		2011	2011	F	
	M FLTRUSE CVO Road Glide Ultra	1802		2011	2011	R	
	M FLTRUSE CVO Road Glide Ultra	1802		2015	2015	F	
	M FLTRUSE CVO Road Glide Ultra	1802		2015	2015	R	
	M FLHTK Ultra Limited	1868		2019		F	
	M FLHTK Ultra Limited	1868		2019		R	
	M FLHTKL Ultra Limited	1868		2019		F	
	M FLHTKL Ultra Limited	1868		2019		R	
	M FLHXS Street Glide Special	1868		2019		F	
	M FLHXS Street Glide Special	1868		2019		R	
	M FLTRU Road Glide Ultra	1868		2019		F	
	M FLTRU Road Glide Ultra	1868		2019		R	
	M FLTRXS Road Glide Special	1868		2019		F	
	M FLTRXS Road Glide Special	1868		2019		R	
	M FLTRXSE CVO Road Glide	1923		2018		F	
	M FLTRXSE CVO Road Glide	1923		2018		R	
	M FLHTKSE CVO Limited	1923		2018		F	
	M FLHTKSE CVO Limited	1923		2018		R	
	M FLHXSE-SE2-SE3 CVO Street Glide	1923		2018		F	
	M FLHXSE-SE2-SE3 CVO Street Glide	1923		2018		R	

M = MOTORCYCLE
S = SCOOTER
A = ATV
Sn = SNOWMOBILE

FDB2212



81.8 x 37.7 x 9.6 mm

August 2016: AG superseded by EF

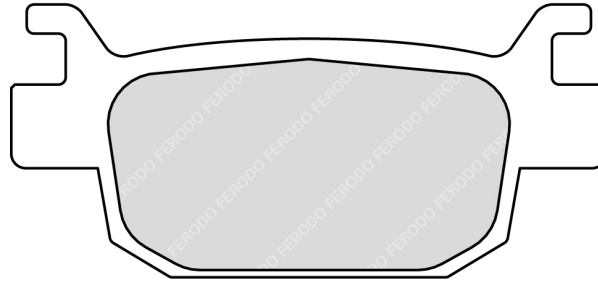
MATERIAL AVAILABILITY											
AG	EF	P	PRP	ST	SM	SG	ZR	XRAC	ZRAC	CP1	CPRO
✗	✓			✓	✓						



CROSS REFERENCE	
BRAKING	908
BREMBO	07064
BREMBO	7064
BRENTA	3082
BRENTA	4082
CL BRAKES	3083
EBC	SFA415
GALFER	FD345
GOLD FREN	287
LUCAS/TRW	MCB806
NEWFREN	FD0401
SBS	193
VESRAH	VD-173

		CC	KW	FROM	TO	FRONT REAR	LEFT RIGHT
	BENELLI						
	M BN 302	300		2015		R	
	M TORNADO 302	300		2016		R	
	HONDA						
	M FES 125 S-WING	125		2007		R	
	S NSS 125 FORZA (JF69)	125	11	2017		R	
	S NSS 125 FORZA (JF60)	125	11	2015		R	
	M SH 125i (JF23)	125	10	2008	2012	R	
	S SH 125i (JF41)	125	9	2013		R	
	S SH 125i	125		2020		R	
S SH 150i	125		2020		R		

		CC	KW	FROM	TO	FRONT REAR	LEFT RIGHT
	M FES 150 S-WING	150		2007	2013	R	
	M SH 150i (KF10)	150	12	2009	2012	R	
	S SH 150i (KF13)	150	11	2013		R	
	S NSS 250 FORZA EX (ABS)	250		2005	2008	R	
	S NSS 250 FORZA X	250		2005	2008	R	
	S NSS 300 FORZA	300	18	2019		R	
	S NSS 300 FORZA (NF04)	300	18	2013		R	
	M SH 300i (NF02)	300	20	2007	2014	R	
	S SH 300i ABS (NF05)	300	19	2015		R	

FDB2213

89.4 x 40.7 x 9.8 mm

MATERIAL AVAILABILITY											
AG	EF	P	PRP	ST	SM	SG	ZR	XRAC	ZRAC	CP1	CPRO
		✓		✓							

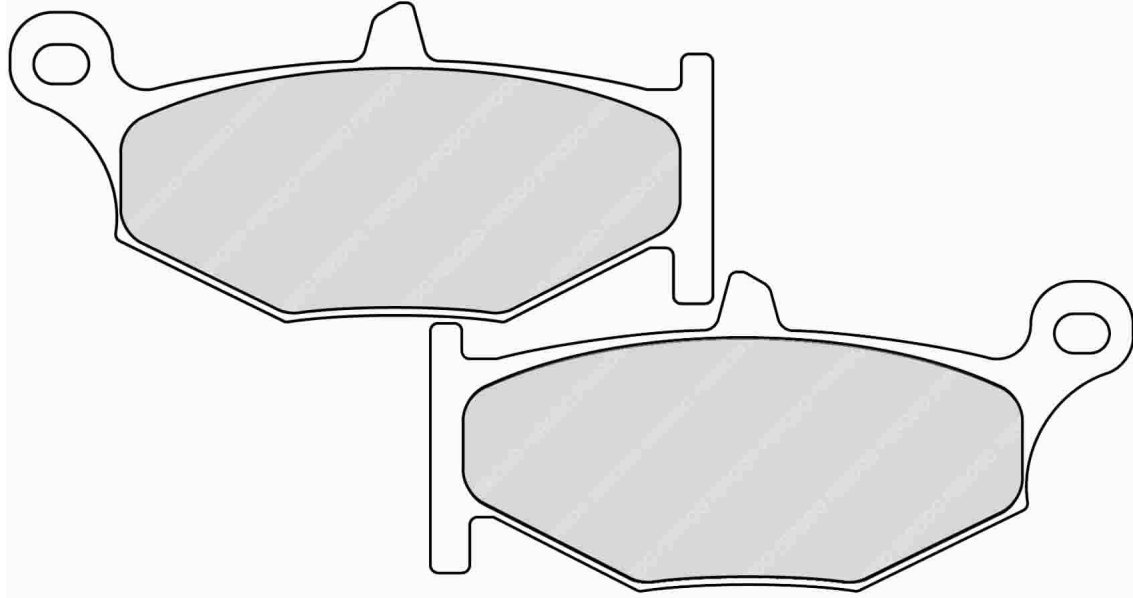

CROSS REFERENCE	
BRAKING	924
BREMBO	07SU32
BRENTA	3131
BRENTA	4131
CL BRAKES	1163
EBC	FA419
GALFER	FD359
GOLD FREN	241
NEWFREN	FD0402
SBS	833
VESRAH	VD-359

		CC	KW	FROM	TO	FRONT REAR	LEFT RIGHT
	M GSR 600 /A / ABS	600		2006	2008	R	
	M GSX-R 600	600		2006	2010	R	
	M GSX-R 600 - Racing Applications	600		2006		R	
	M GSX-R 750 - Racing Applications	750		2006		R	
	M DL 1000 V-STROM ABS (DD1)	1000	74	2014		R	
	M GSX-R 1000	1000		2007	2008	R	
	M GSX-R 1000 Yoshimura 2008	1000		2010		R	
	M V-Strom 1000 ABS	1037		2016		R	

		CC	KW	FROM	TO	FRONT REAR	LEFT RIGHT
	M V-Strom 1000-XT ABS	1037		2016		R	
	M V-Strom 1050	1050		2020		R	
	M GSX 1300 B-KING / Hyaku	1300		2007		R	
	M GSX-R 1300 HAYABUSA (Tokico Front std caliper)	1300		2008	2012	R	
	M GSX-R 1300	1300		2008		R	
	M GSX-R 1300 HAYABUSA ABS (Brembo Caliper-Road pad)	1300		2013		R	
	M B-KING	1340		2010		R	

M = MOTORCYCLE
S = SCOOTER
A = ATV
Sn = SNOWMOBILE

FDB2214

79.1 x 69.1 x 10.3 mm

MATERIAL AVAILABILITY											
AG	EF	P	PRP	ST	SM	SG	ZR	XRAC	ZRAC	CP1	CPRO
						!					

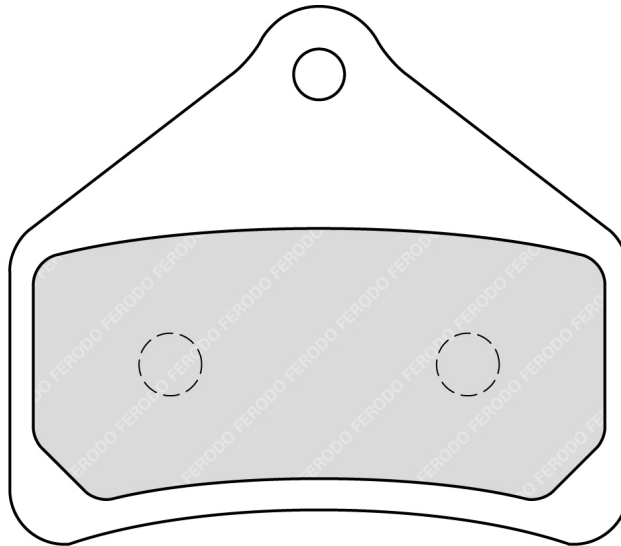

CROSS REFERENCE	
NEWFREN	FD0442



ARCTIC CAT

A F-series Diamond Drive

CC	KW	FROM	TO	FRONT REAR	LEFT RIGHT
		2005		F	

FDB2215

35.2 x 39.7 x 8.5 mm

For OEM numbers see FDB2120 (Set=4 Pads)

MATERIAL AVAILABILITY											
AG	EF	P	PRP	ST	SM	SG	ZR	XRAC	ZRAC	CP1	CPRO
								✓			

ALSO AVAILABLE

SHAPE	TH. MM	NOTES
FDB2120	7.6	Road Version
FDB2255	9	Only for BMW



Pinze / Calipers

BREMBO

P4 34 Axial caliper Four Pads XA32950

CROSS REFERENCE	
GOLD FREN	177
NEWFREN	FD0413

FDB2216

68.6 x 55.5 x 9.2 mm

MATERIAL AVAILABILITY											
AG	EF	P	PRP	ST	SM	SG	ZR	XRAC	ZRAC	CP1	CPRO
		✓		✓	✓					✓	

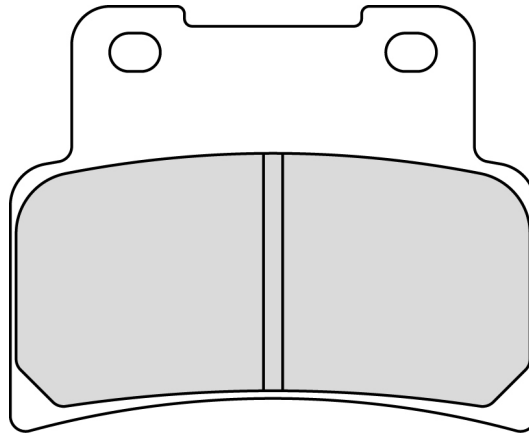

CROSS REFERENCE	
BRAKING	933
BREMBO	07GR77
BREMBO	7100
BRENTA	3098
BRENTA	4098
CL BRAKES	1187
EBC	FA432
LUCAS/TRW	MCB847
NEWFREN	FD0404
SBS	844

		CC	KW	FROM	TO	FRONT / REAR	LEFT / RIGHT
 APRILIA	M RS 125 2T RADIAL CALIPER	125		2006	2012	F	
	M SL 750 SHIVER ABS / GT	750		2008		F	
	M SMV 750 Dorsoduro (NO ABS/ABS)	750		2008		F	
	M NA 850 MANA ABS / GT	850		2008		F	
	M Dorsoduro	900		2017		F	
	M Shiver	900		2017		F	

		CC	KW	FROM	TO	FRONT / REAR	LEFT / RIGHT
 YAMAHA	M MT-125 (RE11)	125	11	2015	2019	F	
	M MT-125A (RE11) ABS	125	11	2015	2019	F	
	M MT-125	125		2020		F	
	M YZF-R 125	125		2014	2018	F	
	M YZF-R 125	125		2019		F	

M = MOTORCYCLE
S = SCOOTER
A = ATV
Sn = SNOWMOBILE

FDB2217

62.1 x 44.6 x 8.9 mm / 31.0 x 48.1 x 8.9 mm

Thickness 9,5mm for racing compounds CP1 / XRAC; (Set=4 Pads)

MATERIAL AVAILABILITY											
AG	EF	P	PRP	ST	SM	SG	ZR	XRAC	ZRAC	CP1	CPRO
				✓				✓	✓	⚠	✓

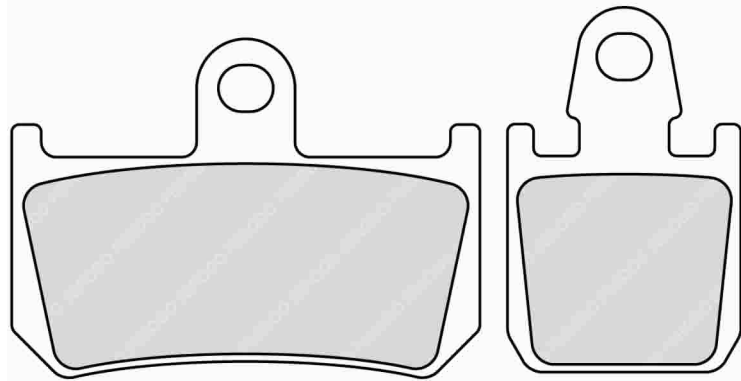

CROSS REFERENCE	
BRAKING	928
BREMBO	07YA46
BRENTA	4118
CL BRAKES	1180
EBC	FA442
GALFER	FD365
GOLD FREN	246
LUCAS/TRW	MCB795
NEWFREN	FD0407
SBS	839
VESRAH	VD-277

		CC	KW	FROM	TO	FRONT / REAR	LEFT / RIGHT
 YAMAHA	M YZF 1000 R1	1000		2007	2014	F	
	M MT-01	1670		2007		F	

		CC	KW	FROM	TO	FRONT / REAR	LEFT / RIGHT
 M	V-MAX	1680		2009		F	

FDB2219

94.1 x 31.5 x 7.2 mm

MATERIAL AVAILABILITY											
AG	EF	P	PRP	ST	SM	SG	ZR	XRAC	ZRAC	CP1	CPRO
						✓	✓				

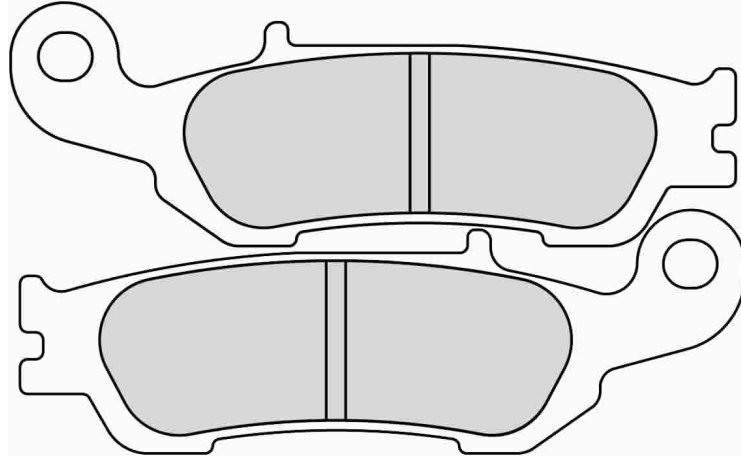

CROSS REFERENCE	
BRAKING	929
BREMBO	07YA47
BRENTA	3105
BRENTA	4105
EBC	FA450
LUCAS/TRW	MCB791
NEWFREN	FD0411
SBS	840
VESRAH	VD-280

		CC	KW	FROM	TO	FRONT REAR	LEFT RIGHT
	HARLEY DAVIDSON	M	FLHRXS Road King Special	1745		2018	R
	YAMAHA	M	YZ 125	125		2008	F
		M	YZ 250 F (4T)	250		2007	F
		M	YZ 250 (2T)	250		2008	F

		CC	KW	FROM	TO	FRONT REAR	LEFT RIGHT
		M	YZ 250 F 60th Anniv.	250		2016	F
		M	WR 450 F	450		2019	F
		M	YZ 450 F	450		2008	F
		M	YZ 450 F 60th Anniv.	450		2016	F

M = MOTORCYCLE
S = SCOOTER
A = ATV
Sn = SNOWMOBILE

FDB2220

37.9 x 50.0 x 9.5 mm

ATTENTION: Thickness for ST material is 7.9mm (Set=4 Pads)

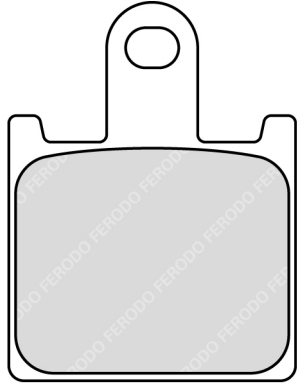

MATERIAL AVAILABILITY											
AG	EF	P	PRP	ST	SM	SG	ZR	XRAC	ZRAC	CP1	CPRO
				✓				✓		⚠	✓

CROSS REFERENCE	
BRAKING	927
BREMBO	07KA28
BRENTA	4115
CL BRAKES	1177
EBC	FA417/4
GOLD FREN	249
LUCAS/TRW	MCB789
NEWFREN	FD0419
SBS	838

		CC	KW	FROM	TO	FRONT / REAR	LEFT / RIGHT
 KAWASAKI	M ZX 6R 600 NINJA	600		2007		F	
	M Z 750 R	750		2011		F	
	M Z 1000	1000		2007	2009	F	
	M Z 1000 / SE	1000		2012		F	
	M Z 1000 SX	1000		2012	2016	F	

		CC	KW	FROM	TO	FRONT / REAR	LEFT / RIGHT
 HONDA	M 1400 GTR	1400		2007		F	
	M 1400 GTR	1400		2015		F	
	M ZZR 1400	1400		2006		F	
	M ZZR 1400	1400		2016		F	

FDB2221

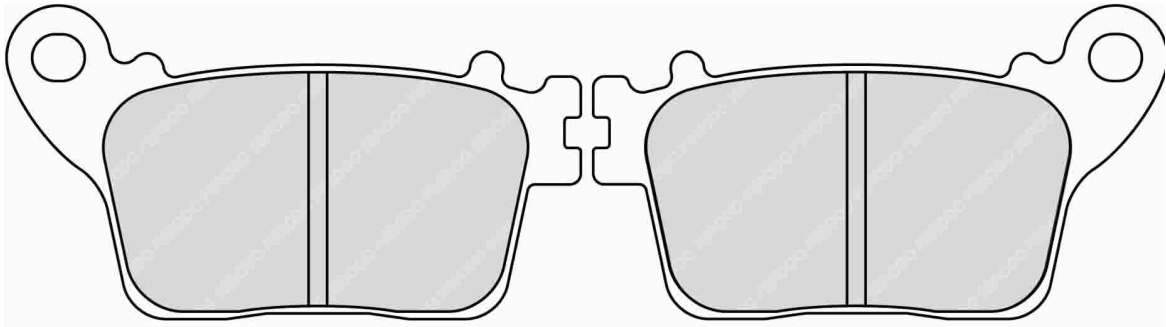

76.6 x 42.1 x 8.9 mm

MATERIAL AVAILABILITY											
AG	EF	P	PRP	ST	SM	SG	ZR	XRAC	ZRAC	CP1	CPRO
		✓		✓							



CROSS REFERENCE	
BRAKING	925
BREMBO	07HO59
CL BRAKES	1174
EBC	FA436
GALFER	FD363
GOLD FREN	242
LUCAS/TRW	MCB784
LUCAS/TRW	MCB785
NEWFREN	FD0412
SBS	834
VESRAH	VD-174

		CC	KW	FROM	TO	FRONT / REAR	LEFT / RIGHT
	HONDA						
	M CB 600 F HORNET	600		2007		R	
	M CBR 600 F / ABS	600		2011		R	
	M CBR 600 RR / Lim. Ed. / Fireblade Repsol	600		2007		R	
	M CBR 1000 RR FIREBLADE / Hansspree Ed.	1000		2006	2013	R	
	M CBR 1000 RR Fireblade	1000	141	2014		R	
M CBR 1000 RR Fireblase SP	1000	141	2014		R		
M CBR 1000 RR Fireblade SP-1/SP2	1000		2017		R		
	KAWASAKI						
	M ZX-6R Ninja	636	95	2019		R	
	M ZX 6R 636 NINJA	636		2013		R	
	M ZX-10RR Ninja	998	149	2017		R	
	M ZX-10R 1000 SE Ninja	998	149	2018		R	
	M ZX-10R 1000	1000	149	2011	2015	R	
M ZX-10R 1000	1000	149	2016		R		
M ZX-10R Winter test Ed.	1000		2016		R		

		CC	KW	FROM	TO	FRONT / REAR	LEFT / RIGHT
	SUZUKI						
	M GSX-R 600	600		2011		R	
	M GSX-R 750	750		2011		R	
	M GSX-R 1000	1000		2009	2011	R	
	M GSX-R 1000 Alstare 25 Ann.	1000		2010		R	
	M GSX-R 1000 No ABS	1000		2012		R	
	M GSX-R 1000 ABS	1000		2015	2019	R	
	M GSX-R 1000 CONCEPT	1000		2016		R	
	M GSX-R 1000 R ABS	1000		2017		R	
	M GSX-R 1000 - Racing Applications	1000		2009		R	
	YAMAHA						
	M YZF 600 R6	600		2017	2019	R	
	M YZF 1000 R1	1000		2015		R	
	M YZF 1000 R1M	1000		2015		R	
M YZF 1000 R1 60th Anniversary	1000		2016		R		

M = MOTORCYCLE
S = SCOOTER
A = ATV
Sn = SNOWMOBILE

FDB2224

77.2 x 41.2 x 9.0 mm

MATERIAL AVAILABILITY											
AG	EF	P	PRP	ST	SM	SG	ZR	XRAC	ZRAC	CP1	CPRO
	✓	✓									

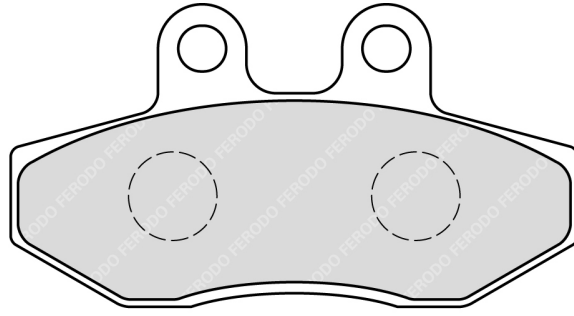

CROSS REFERENCE	
BREMBO	07068
BREMBO	7068
BRENTA	3077
BRENTA	4077
EBC	FA393
EBC	SFA393
GALFER	FD342
LUCAS/TRW	MCB774
NEWFREN	FD0414
SBS	823
VESRAH	VD-273

		CC	KW	FROM	TO	FRONT REAR	LEFT RIGHT
YAMAHA	M	NCX 125 CYGNUS X 220mm disc (5ML)	125		2004	2006	F
	S	NCX 125 CYGNUS X 240mm disc (4P9)	125		2006	2013	F

		CC	KW	FROM	TO	FRONT REAR	LEFT RIGHT
M	CYGNUS X 250	250		2007		F	

FDB2225

102.1 x 39.0 x 10.3 mm

May 2016: AG superseded by EF

MATERIAL AVAILABILITY											
AG	EF	P	PRP	ST	SM	SG	ZR	XRAC	ZRAC	CP1	CPRO
✗	✓				✓						

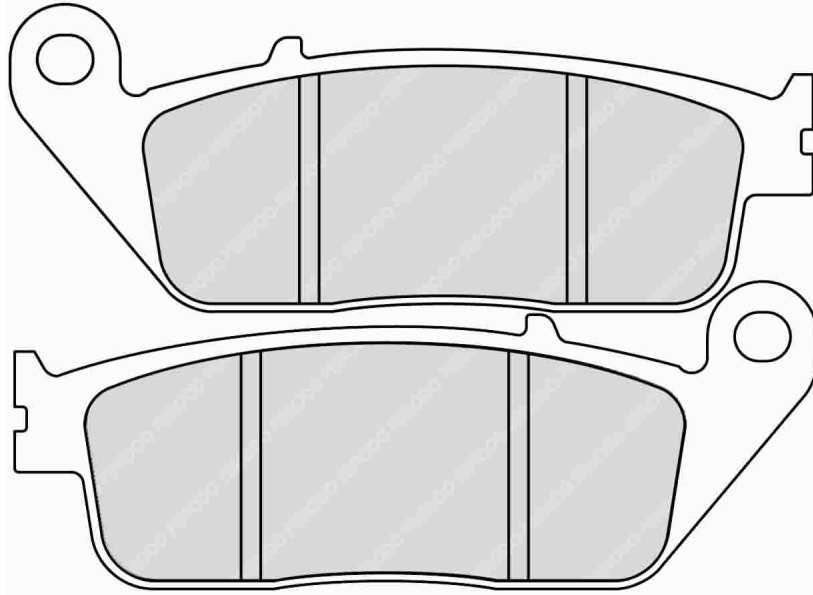

ALSO AVAILABLE		
SHAPE	TH. MM	NOTES
FDB570	8.3	
FDB664	9.8	
FDB2288	10.5	With Pin

CROSS REFERENCE	
BRAKING	748
BREMBO	07HO34
BREMBO	7096
CL BRAKES	3097
EBC	FA196
GALFER	FD140
GOLD FREN	014
LUCAS/TRW	MCB631
NEWFREN	FD0406
SBS	181
SBS	654
VESRAH	VD-156/3

		CC	KW	FROM	TO	FRONT / REAR	LEFT / RIGHT
	S SH 125i (JF41)	125	9	2013		F	
	S SH 125i	125		2020		F	
	S SH 150i	125		2020		F	
	S SH 150i (KF13)	150	11	2013		F	
	S SH 300i ABS (NF05)	300	19	2015		F	
KYMCO	S PEOPLE 250	250		2003	2005	R	
YAMAHA	S X-CITY 125	125		2008		F	
	S YP 125 R X-MAX (Nissin Front) NO ABS	125		2010	2013	F	
	S YP 125 RA X-MAX (Nissin Front) (39D2) ABS	125		2011		F	
	S YP 125 R X-MAX (Nissin Front) NO ABS	125		2014		F	

		CC	KW	FROM	TO	FRONT / REAR	LEFT / RIGHT
	S YP125RA X-MAX IRON MAX ABS	125		2016		F	
	S X-CITY 250	250		2008		F	
	S X-Max 250 (SG22)	250	15	2010	2013	F	
	S X-Max 250 ABS (SG22)	250	15	2011		F	
	S X-Max 250 (SG22)	250		2014		F	
	S X-Max 250 Momodesign (SG22)	250	15	2015		F	
	S X-Max IRON MAX ABS	250		2016		F	
	S X-Max 400 ABS	400	23	2013		F	
	S X-Max 400	400	23	2013		F	
	S X-Max 400RA IRON MAX ABS	400		2016		F	

M = MOTORCYCLE
S = SCOOTER
A = ATV
Sn = SNOWMOBILE

FDB2226

94.1 x 36.2 x 10.2 mm

MATERIAL AVAILABILITY

AG	EF	P	PRP	ST	SM	SG	ZR	XRAC	ZRAC	CP1	CPRO
✓	✓										

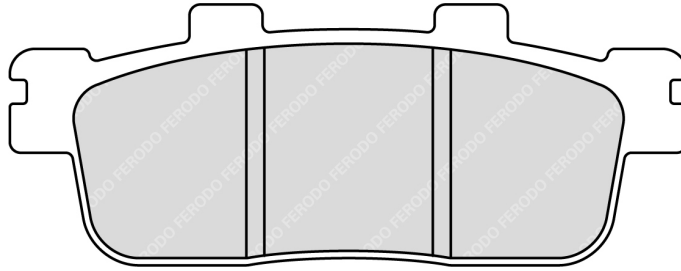
**CROSS REFERENCE**

BRAKING	948
BREMBO	07040
BREMBO	7040
BRENTA	3100
BRENTA	3102
BRENTA	4100
BRENTA	4102
EBC	FA427
EBC	SFA607
GALFER	FD399
GOLD FREN	286
LUCAS/TRW	MCB800
NEWFREN	FD0417
SBS	195
SBS	201
SBS	847

		CC	KW	FROM	TO	FRONT REAR	LEFT RIGHT
	PEUGEOT						
	S LXR 125 (4T)	125		2010	2012	R	
	S LXR 200i (4T)	200		2010	2011	R	
SYM	S City Com 125	125		2008	2013	R	
	M GTS 125	125		2006	2009	F	
	M GTS 125	125		2006	2009	R	
	S GTS 125 i	125		2010	2015	R	
	S Joymax 125 i GTS Sport	125		2016		R	
	M HD Evo 125 (Carb & EFI Models/4T/Single Headlight)	125		2003		R	
	M HD2- 125i (4T)	125		2010		R	
	M JOYRIDE 125 EURO2	125		2005	2006	R	
	S JOYRIDE (Euro2 - Euro3)	125		2005	2006	R	
	S Joyride 125 i	125		2007	2009	R	
	S Joyride EVO 125 i (Twin Headlights)	125		2009		R	
	S Joyride S 125i	125		2016		R	
	M SB 125 Ni - Wolf (EFI Model)	125		2011		F	
	S HD 200 EVO Euro 2-3 / EVO 1 Euro 2-3	200		2005	2006	R	
	S HD200 S Evo	200		2007		R	
	S HD2-200i (Twin H/Lights/4T)	200		2010		R	
	S Joyride 200 i	200		2007	2009	R	

		CC	KW	FROM	TO	FRONT REAR	LEFT RIGHT
	S						
	S Joyride EVO 200 i	200		2009		R	
	S Joyride S. 200i	200		2016		R	
	S GTS 250	250		2007	2008	R	
	S Joymax 250 i GTS (All Models)	250		2009	2015	R	
	S Joymax 250 i GTS Sport	250		2016		R	
	S JOYMAX 250	250		2006	2007	R	
	S Joymax 250 i	250		2007	2008	R	
	S Cruisym 300 i	300		2017		R	
	S Joymax 300 GTS (All Models)	300		2008	2015	R	
	S Joymax 300 i GTS Sport	300		2016		R	
SYM ATV	A Quadlander 200	200		2012	2013	R	
	A Trackrunner 200 Quad	200		2005	2009	R	
	A Quadlander 250	250		2005	2009	R	
	A Citymax 300 Quad	300		2006		R	
TGB	S X-Motion125	125		2008		R	
	S X-Motion125 R i	125		2011	2012	R	
	S X-Motion250i	250		2008	2010	R	
	S X-Motion300 Efi	300		2010	2012	R	

4288

FERODO

RACING

Updated on November 2020

M = MOTORCYCLE
S = SCOOTER
A = ATV
Sn = SNOWMOBILE

FDB2228

82.2 x 28.8 x 9.5 mm

Brembo GP Type 4 Pistons (Set=4 Pads)

MATERIAL AVAILABILITY											
AG	EF	P	PRP	ST	SM	SG	ZR	XRAC	ZRAC	CP1	CPRO
								✗		✗	🔄

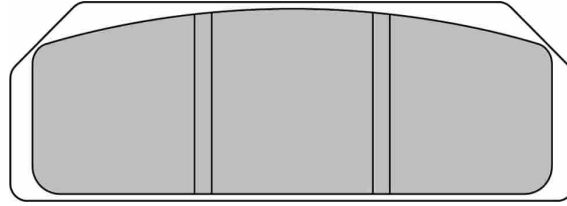

Pinze / Calipers

BREMBO

GP Type XA3.J7&XA8.Y3 Radial Mount (Pinless Fixing)

CROSS REFERENCE	
BREMBO	07.8354.24
EBC	GPFAX611HH
LUCAS/TRW	MCB815
NEWFREN	FD0509
SBS	845

FDB2230

107.4 x 36.7 x 8.0 mm / 91.7 x 36.5 x 8.0 mm

MATERIAL AVAILABILITY											
AG	EF	P	PRP	ST	SM	SG	ZR	XRAC	ZRAC	CP1	CPRO
						✓					

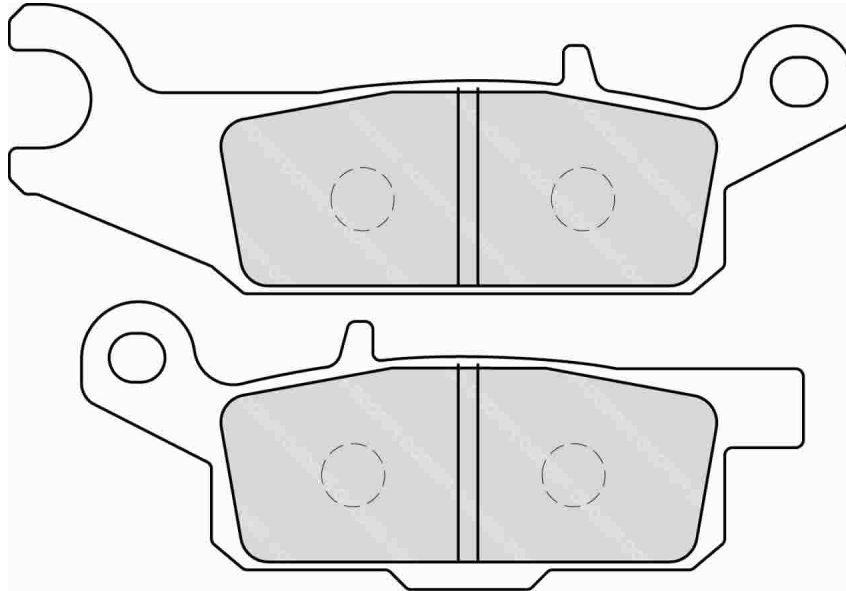

ALSO AVAILABLE

SHAPE	TH. MM	NOTES
FDB2231		Coupled set

CROSS REFERENCE	
BREMBO	07YA48
EBC	FA444
LUCAS/TRW	MCB802
NEWFREN	FD0429
SBS	849
VESRAH	VD-278/2

		CC	KW	FROM	TO	FRONT / REAR	LEFT / RIGHT
YAMAHA ATV	A	YFM 250 R Raptor	250	2008		F	right
	A	YFM 250 RSPX Special Edition Custom	250	2008		F	right
	A	YFM 550 4x4 Grizzly	550	2008		F	right

		CC	KW	FROM	TO	FRONT / REAR	LEFT / RIGHT
A	A	YFM 700 Ducks Unlimited Edition	700	2007	2009	F	right
	A	YFM 700 GRIZZLY	700	2008		F	right

FDB2231

107.4 x 36.7 x 8.0 mm / 91.7 x 36.5 x 8.0 mm

MATERIAL AVAILABILITY											
AG	EF	P	PRP	ST	SM	SG	ZR	XRAC	ZRAC	CP1	CPR0
						✓					

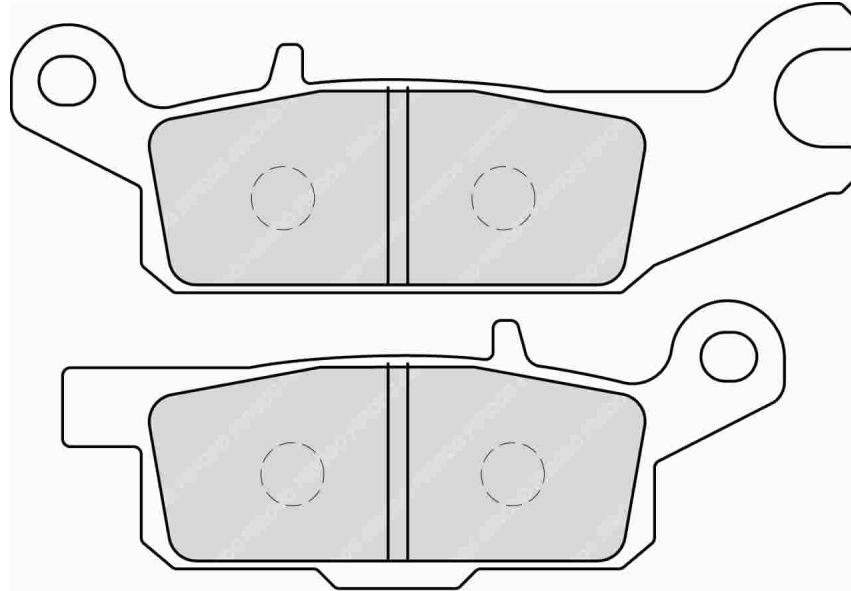

ALSO AVAILABLE		
SHAPE	TH. MM	NOTES
FDB2230		Coupled set

CROSS REFERENCE	
BREMBO	07YA49
EBC	FA443
LUCAS/TRW	MCB801
NEWFREN	FD0427
NEWFREN	FD0430
SBS	850
VESRAH	VD-279/2

		CC	KW	FROM	TO	FRONT / REAR	LEFT / RIGHT
YAMAHA ATV	A	YFM 250 RSPX Special Edition Custom	250	2008		F	left
	A	YFM 250 R Raptor	250	2008		F	left
	A	YFM 550 4x4 Grizzly	550	2008		F	left

		CC	KW	FROM	TO	FRONT / REAR	LEFT / RIGHT
A	A	YFM 700 Ducks Unlimited Edition	700	2007	2009	F	left
	A	YFM 700 GRIZZLY	700	2008		F	left

FDB2232

107.4 x 36.7 x 9.0 mm / 91.7 x 36.5 x 9.0 mm

MATERIAL AVAILABILITY											
AG	EF	P	PRP	ST	SM	SG	ZR	XRAC	ZRAC	CP1	CPRO
						✓					

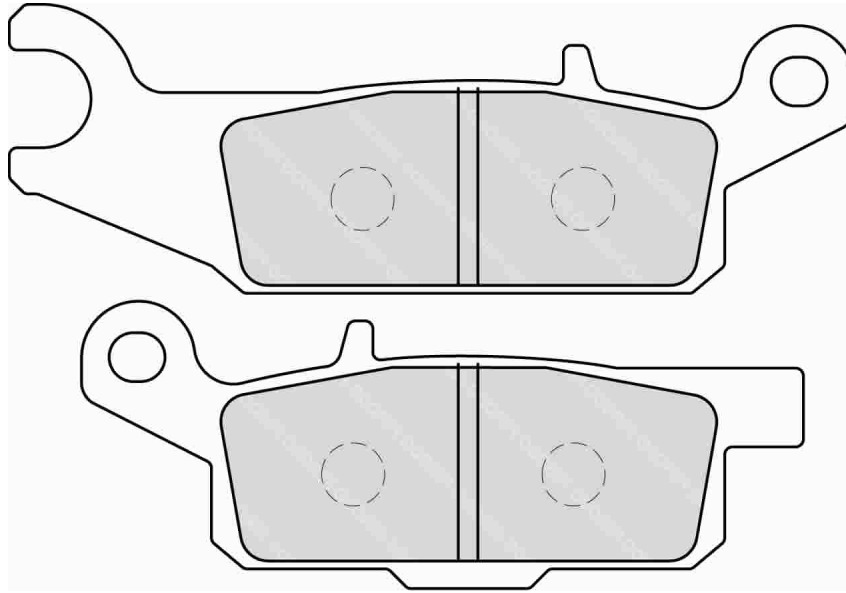

ALSO AVAILABLE		
SHAPE	TH. MM	NOTES
FDB2233		Coupled set

CROSS REFERENCE	
BREMBO	07YA50
EBC	FA446
LUCAS/TRW	MCB804
NEWFREN	FD0428
NEWFREN	FD0430
SBS	851
VESRAH	VD-278

		CC	KW	FROM	TO	FRONT / REAR	LEFT / RIGHT
 YAMAHA ATV	A	YFM 550 4x4 Grizzly	550	2008		R	right
	A	YFM 700 Ducks Unlimited Edition	700	2007	2009	R	right

		CC	KW	FROM	TO	FRONT / REAR	LEFT / RIGHT
 A	YFM 700 GRIZZLY	700		2008		R	right

M = MOTORCYCLE
S = SCOOTER
A = ATV
Sn = SNOWMOBILE

FDB2233

107.4 x 36.7 x 9.0 mm / 91.7 x 36.5 x 9.0 mm

MATERIAL AVAILABILITY											
AG	EF	P	PRP	ST	SM	SG	ZR	XRAC	ZRAC	CP1	CPRO
						✓					

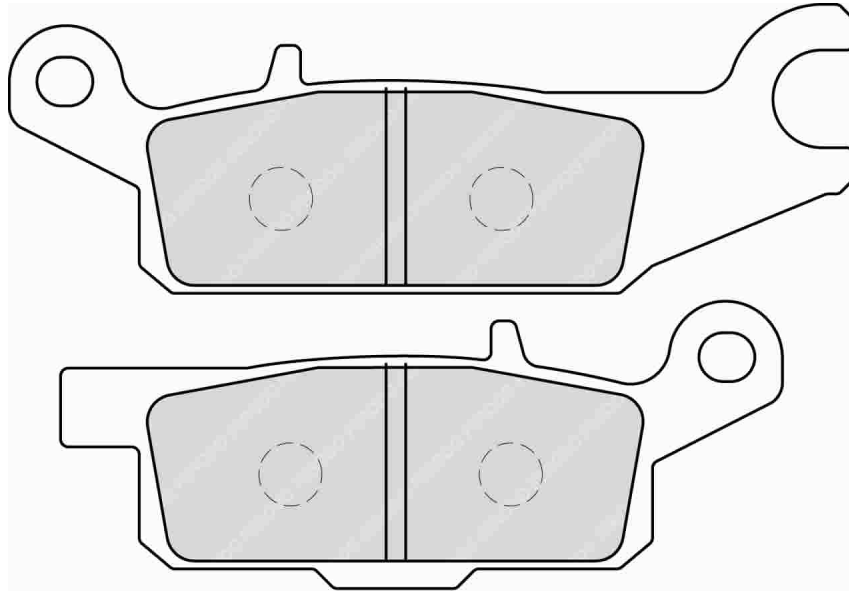

ALSO AVAILABLE		
SHAPE	TH. MM	NOTES
FDB2232		Coupled set

CROSS REFERENCE	
BREMBO	07YA51
EBC	FA445
LUCAS/TRW	MCB803
NEWFREN	FD0428
SBS	852
VESRAH	VD-279

		CC	KW	FROM	TO	FRONT / REAR	LEFT / RIGHT
 YAMAHA ATV	A	YFM 550 4x4 Grizzly	550		2008	R	left
	A	YFM 700 Ducks Unlimited Edition	700		2007	2009	R

		CC	KW	FROM	TO	FRONT / REAR	LEFT / RIGHT
 A	YFM 700 GRIZZLY	700		2008		R	left

FDB2235

82.2 x 40.9 x 9.4 mm / 62.1 x 40.9 x 9.4 mm

with pin 3mm on the little backplate. See also FDB2149 for version without pin

MATERIAL AVAILABILITY											
AG	EF	P	PRP	ST	SM	SG	ZR	XRAC	ZRAC	CP1	CPRO
						✓					

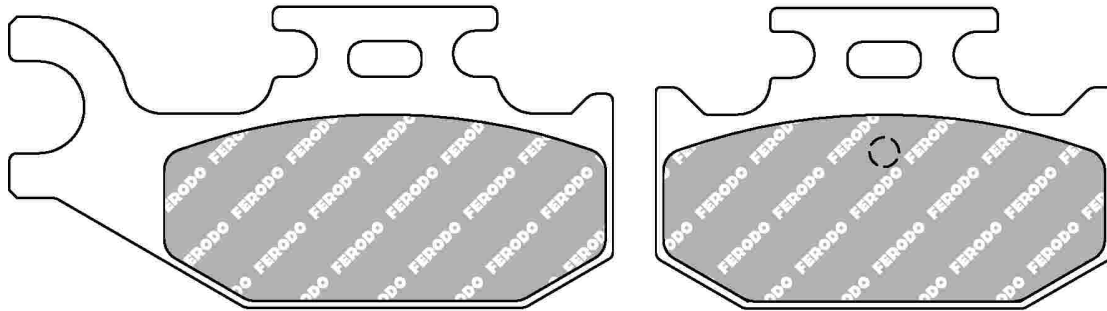

CROSS REFERENCE	
BREMBO	07GR50
BRENTA	3144
BRENTA	4144
CL BRAKES	1102
EBC	FA428
NEWFREN	FD0426



YAMAHA ATV	A	YFM 700 RAPTOR - All Models	CC	KW	FROM	TO	FRONT / LEFT	
							REAR	RIGHT
			700		2006		R	

FDB2236

97.1 x 51.2 x 7.7 mm

MATERIAL AVAILABILITY											
AG	EF	P	PRP	ST	SM	SG	ZR	XRAC	ZRAC	CP1	CPRO
						✓					

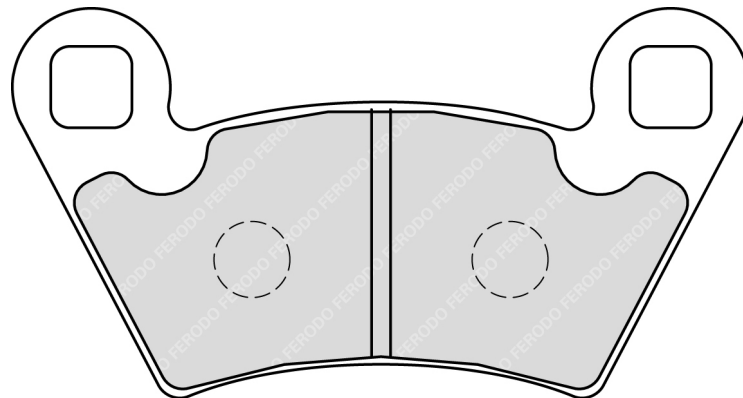

CROSS REFERENCE	
BREMBO	07PO07
EBC	FA354
NEWFREN	FD0435
SBS	800
VESRAH	VD-9024

M = MOTORCYCLE
S = SCOOTER
A = ATV
Sn = SNOWMOBILE



			CC	KW	FROM	TO	FRONT / REAR	LEFT / RIGHT
POLARIS ATV	A	Ranger 2x4/4x4 - side by side			2004	2005	F	
	A	Ranger 2x4/4x4 - side by side			2004	2005	R	
	A	Ranger 6x6 - side by side			2004	2005	F	
	A	Ranger 6x6 - side by side			2004	2005	R	
	A	Ranger TM - side by side			2004		F	
	A	Ranger TM - side by side			2004		R	
	A	Ranger XP - side by side			2005		F	
	A	Ranger XP - side by side			2005		R	
	A	Ranger EV (Electric) - side by side			2010	2011	R	
	A	Ranger 325 ETX - side by side	325		2015	2015	F	
	A	Ranger 325 ETX - side by side	325		2015	2015	R	
	A	Sportsman ACE 325	325		2014	2014	R	
	A	Ranger 400 - side by side	400		2010		R	
	A	Ranger 500 (2x4/4x4) - side by side	500		2006	2007	F	
	A	Ranger 500 (2x4/4x4) - side by side	500		2006	2007	R	
	A	Ranger 500 4x4 EFI - side by side	500		2006	2007	F	
	A	Ranger 500 4x4 EFI - side by side	500		2006	2007	R	
	A	Ranger 500 4x4 EFI - side by side	500		2008		R	
	A	Ranger 500 2x4 - side by side	500		2008		R	
	A	Ranger 500 (Carb) 2x4 -side by side	500		2009		R	
	A	Ranger 500 (EFI) 4x4 H.O. - side by side	500		2009	2011	R	
	A	Ranger 500 Crew - side by side	500		2011		R	
	A	Ranger 570 Crew Efi - side by side	570		2014	2015	R	
	A	Ranger 570 Efi - side by side	570		2014	2014	F	
	A	Ranger 570 Efi - side by side	570		2014	2014	R	
	A	Sportsman ACE 570	570		2015	2015	R	



			CC	KW	FROM	TO	FRONT / REAR	LEFT / RIGHT
	A	Ranger 700 6x6 EFI - side by side	700		2006	2009	F	
	A	Ranger 700 6x6 EFI - side by side	700		2006	2009	R	
	A	Ranger 700 XP 4x4 - side by side	700		2006	2008	F	
	A	Ranger 700 XP 4x4 - side by side	700		2006	2008	R	
	A	Ranger 700 4x4 EFI/LE - side by side	700		2007		F	
	A	Ranger 700 4x4 EFI/LE - side by side	700		2007		R	
	A	Ranger 700 6x4 EFI - side by side	700		2008		R	
	A	Ranger 700 XP 4x4 - side by side	700		2008		R	
	A	Ranger 700 4x4 EFI - side by side	700		2009		R	
	A	Ranger 800 HD - side by side	800		2010		R	
	A	Ranger 800 XP - side by side	800		2010	2012	R	
	A	Ranger 800 6x6 - side by side	800		2010		R	
	A	Ranger 800 Crew - side by side	800		2010		R	
	A	Ranger 800 RZR-4 EFI - side by side	800		2010		R	
	A	Ranger 800 - side by side	800		2010	2012	R	
	A	Ranger 800 RZR-4 EPS - side by side	800		2012	2012	R	
	A	Ranger 800 RZR EFI - side by side	800		2013	2014	R	
	A	Ranger 800 Mid Size - side by side	800		2013	2014	F	
	A	Ranger 800 Mid Size - side by side	800		2013	2014	R	
	A	RZR-4 800 - side by side	800		2012	2012	R	
	A	Ranger 900 D 4x4 Diesel - side by side	900		2011		R	
	A	Ranger 900 RZR XP - side by side	900		2011	2012	R	
	A	Polaris Razor XP900 - side by side	900		2012		R	
	A	Ranger 1000 D Crew - side by side	1000		2015	2015	R	
	A	Ranger 1000 D- side by side	1000		2015	2015	R	

FDB2238

95.8 x 37.6 x 8.3 mm / 109.8 x 51.5 x 8.3 mm

April 2017: AG superseded by EF

MATERIAL AVAILABILITY											
AG	EF	P	PRP	ST	SM	SG	ZR	XRAC	ZRAC	CP1	CPRO
✗	✓	✓									

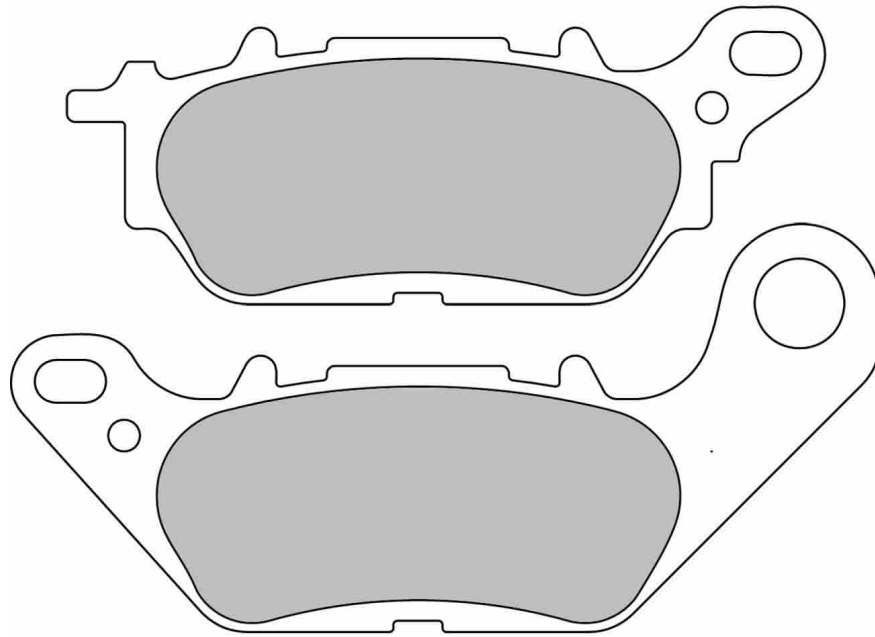

CROSS REFERENCE	
BREMBO	07YA28
BRENTA	3152
BRENTA	4152
EBC	FA464
GALFER	FD393
GOLD FREN	264
LUCAS/TRW	MCB812
NEWFREN	FD0437
SBS	858
VESRAH	VD-282

		CC	KW	FROM	TO	FRONT REAR	LEFT RIGHT
	S XC 115 D'elight	115		2014		F	
	M YS 125	125		2017		F	
	S NMAX (GPD125A)	125		2015		R	
	M VITY 125	125		2008		F	
	M YBR 125 (3D92/9)	125		2007	2009	F	
	M YBR 125 Custom	125		2008	2013	F	
	M YBR 125 (51D1/2)	125		2010	2014	F	

		CC	KW	FROM	TO	FRONT REAR	LEFT RIGHT
	M CRYPTON T135	135		2006		F	
	M YZF-R15 (Indian Model)	150		2008		F	
	M YZF-R15	150		2011		F	
	S NMAX	155	11	2019		R	
	S Tricity 155 ABS	155		2018		R	right
	S Tricity 300	300		2020		R	

M = MOTORCYCLE
S = SCOOTER
A = ATV
Sn = SNOWMOBILE

FDB2240

61.6 x 46.6 x 7.4 mm

Set=4 Pads

MATERIAL AVAILABILITY											
AG	EF	P	PRP	ST	SM	SG	ZR	XRAC	ZRAC	CP1	CPRO
				✓				✗			

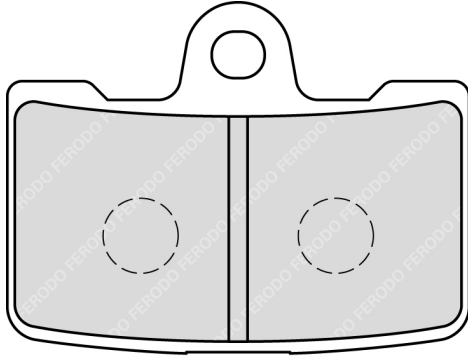

CROSS REFERENCE	
BRAKING	939
BREMBO	07HD19
EBC	FA454/4HH
LUCAS/TRW	MCB810
NEWFREN	FD0438
SBS	856
VESRAH	VD-9038

		CC	KW	FROM	TO	FRONT / REAR	LEFT / RIGHT
	BUELL						
	M 1125R	1125		2008	2010	F	
	M 1125CR	1125		2009	2010	F	
	M XB12 R Firebolt	1200		2009	2010	F	
	M XB12 S Lightning	1200		2009	2010	F	

		CC	KW	FROM	TO	FRONT / REAR	LEFT / RIGHT
							
	M XB12 SCG Lightning	1200		2009	2010	F	
	M XB12 Ss Lightning Long	1200		2009	2010	F	
EBR	M 1190RX	1190		2014	2015	F	
	M 1190SX	1190		2014	2015	F	

FDB2242

111.4 x 36.3 x 7.6 mm / 98.8 x 33.3 x 7.6 mm

September 2017: AG superseded by EF

MATERIAL AVAILABILITY											
AG	EF	P	PRP	ST	SM	SG	ZR	XRAC	ZRAC	CP1	CPRO
✗	✓	✓									

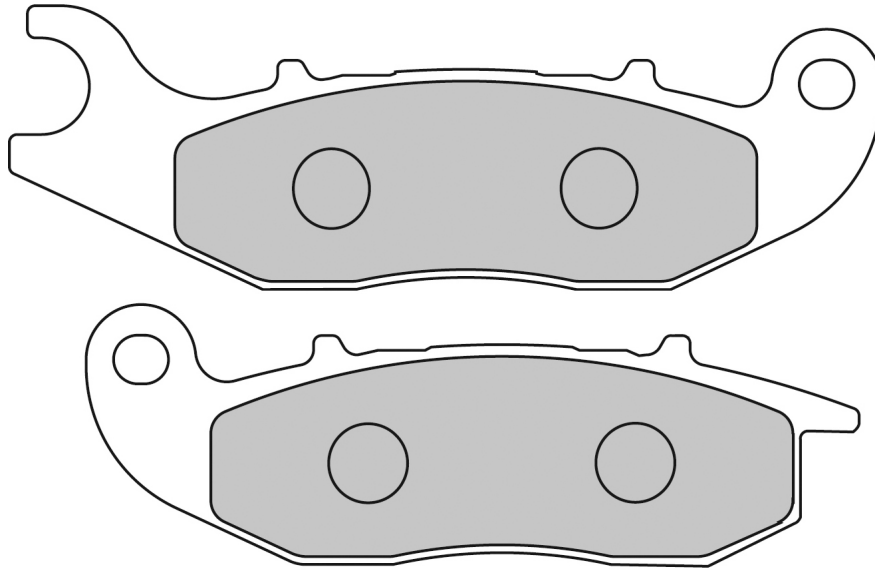

ALSO AVAILABLE		
SHAPE	TH. MM	NOTES
FDB2169		Coupled set

CROSS REFERENCE	
BREMBO	07GR03
BRENTA	4162
EBC	FA465
EBC	FA693
GALFER	FD409
NEWFREN	FD0444
SBS	859
VESRAH	VD-181

		CC	KW	FROM	TO	FRONT REAR	LEFT RIGHT
	AJP	M PR3 125 Enduro	125		2013 2015	F	
		M PR3 125 Enduro Pro	125		2013 2015	F	
		M PR3 125 Extreme	125		2013 2015	F	
		M PR3 125 Supermoto	125		2013 2015	F	
		M PR4 Enduro 125	125		2013 2015	F	
		M PR4 Enduro Pro 125	125		2013 2015	F	
		M PR4 Supermoto 125	125		2013 2015	F	
		M PR4 125 Trial	125		2013 2015	F	
		M PR3 240 M/X Pro	240		2013 2015	F	
		M PR4 240 Extreme	240		2013 2015	F	
		M PR5 250 Enduro	250		2010 2015	F	
		M PR5 250 Extreme	250		2012 2015	F	
		M PR5 250 Supermoto	250		2010 2015	F	
	DERBI	M Cross City 125	125		2009		F
M Mulhacen 125 (4T) From ref no.: 7N001791		125		2007 2010		F	
M TERRA 125		125		2007 2008		F	
M TERRA 125 ADVENTURE		125		2008 2009		F	
M TERRA 125 ADVENTURE		125		2010 2013		F	
FANTIC	M 50E (2T) Enduro Casa	50		2013		F	
	M 50ER (2T) Enduro Competizione	50		2013		F	
	M 50M (2T) Motard Casa	50		2013		F	
	M 50MR (2T) Motard Competizione	50		2013		F	
	M TX 180 E (49cc/2T) Regularita Casa 50E	50		2011 2013		F	
M TX 180 ER (49cc/2T) Regularita Competizione 50ER	50		2011 2013		F		

		CC	KW	FROM	TO	FRONT REAR	LEFT RIGHT
	M TX 180 ES (49cc/2T) Regularita Scuderia 50ES	50		2011	2013	F	
	M TX 180 SM (49cc/2T) Motard Casa 50M	50		2011	2013	F	
	M TX 180 MR (49cc/2T) Motard Competizione 50MR	50		2011	2013	F	
	M 125 E (4T)Enduro Casa	125		2013		F	
	M 125 M (4T)Motard Casa	125		2013		F	
	M 125 MR (4T)Motard Competizione	125		2013		F	
	M TR 125 CR (2T) Cross Competizione	125		2013		F	
	M TR 125 MR (2T) Motard Competizione	125		2013		F	
	M TZ 125 CS (2T) Caballero Cross	125		2011	2012	F	
	M TZ 125 ES (2T) Regularita Scuderia	125		2011	2012	F	
	M TZ 125 SM (2T) Caballero Motard	125		2011	2012	F	
	M TZ 170 E (125 E / 4T) Regularita Casa	125		2011	2013	F	
	M TZ 170 ER (125 ER / 4T) Caballero Reg. Comp.	125		2011	2013	F	
	M TZ 170 SM (125 SM/ 4T) Motard Casa	125		2011	2013	F	
	M 200 ER (4T)Enduro Competizione	200		2011		F	
	M 200 MR (4T)Motard Competizione	200		2011		F	
	M TZ 200 ER (200 ER / 4T) Caballero Reg. Comp.	200		2011	2013	F	
	M TZ 200 MR (200 MR / 4T) Motard	200		2011	2013	F	
	M TF 250 ES (4T)	250		2011	2013	F	
	M TR 250 ES (2T) Enduro Six Day	250		2013		F	
M TR 300 ES (2T) Enduro Six Day	300		2013		F		
M TZ 300 ES Regularita Scuderia	300		2011	2012	F		
HONDA	S PCX	125	9	2019		F	
M CRF 250 LD	250	18	2013		F		

M = MOTORCYCLE
S = SCOOTER
A = ATV
Sn = SNOWMOBILE

		CC	KW	FROM	TO	FRONT / REAR	LEFT / RIGHT
	M	CRF 250 M Supermoto	250		2014	F	
HONDA-HM ITALIA	M	CRE Baja RR HM 125 2T	125		2011	F	
PIAGGIO	S	Liberty 125 4T 3V i-get ABS	125	8	2016	F	
	S	Medley 125 i-get ABS (MA0A)	125	9	2016	F	
	S	Liberty 150 4T 3V i-get ABS	150		2016	F	
	S	Medley 150 i-get ABS	150	11	2016	F	
RIEJU	M	MTR 50 Competizione (Spoke Wheel)	50		2011	F	

		CC	KW	FROM	TO	FRONT / REAR	LEFT / RIGHT
	M	TANGO 50	50		2013	2015	F
	M	Marathon Pro 125 Competizione (Spoke Wheel)	125		2011		F
	M	TANGO 125	125		2011		F
	M	TANGO 250	250		2012	2013	F
SCORPA	M	T-Ride 125 F (Enduro)	125		2010		F
	M	T-Ride 250 F (Enduro)	250		2008	2011	F

FDB2243

86.2 x 43.5 x 10.0 mm

MATERIAL AVAILABILITY

AG	EF	P	PRP	ST	SM	SG	ZR	XRAC	ZRAC	CP1	CPRO
		✓				✓				✗	

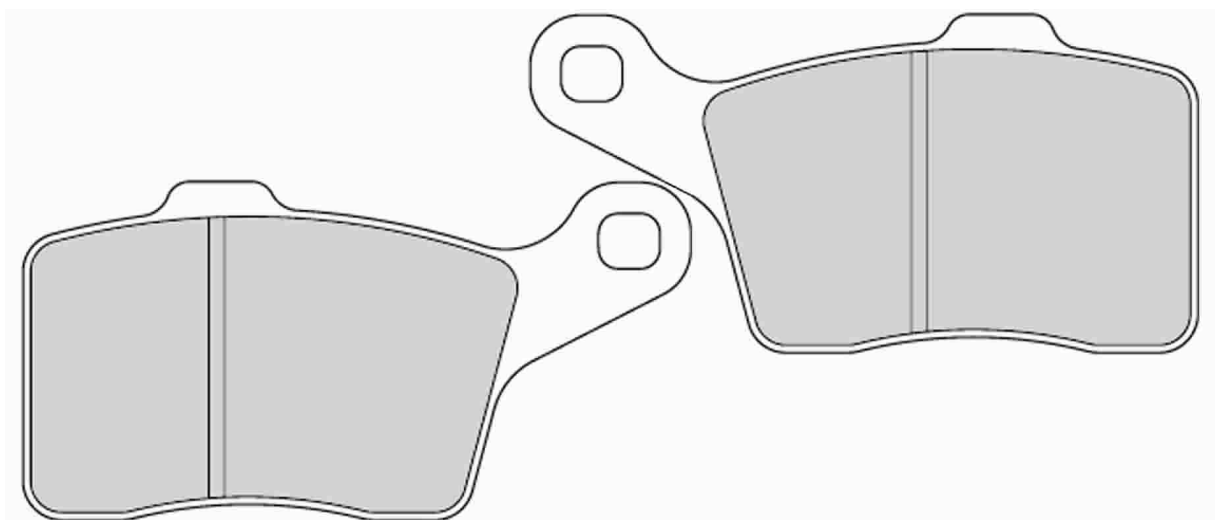

CROSS REFERENCE

BREMBO	07BB35
NEWFREN	FD0448

		CC	KW	FROM	TO	FRONT / REAR	LEFT / RIGHT
SKI DOO SNOWMOBILE	Sn	REV XP			2008	F	

FDB2244

34.9 x 45.9 x 7.7 mm

MAGURA Brake System (Set=4 Pads)

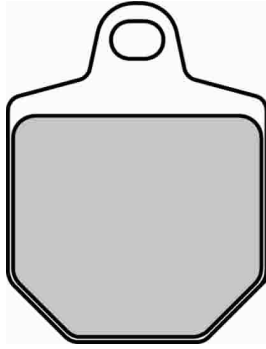

MATERIAL AVAILABILITY											
AG	EF	P	PRP	ST	SM	SG	ZR	XRAC	ZRAC	CP1	CPRO
				✓				✗			

CROSS REFERENCE	
BRAKING	932
BREMBO	07GR76
EBC	FA433/4
LUCAS/TRW	MCB794
NEWFREN	FD0363
SBS	843

		CC	KW	FROM	TO	FRONT REAR	LEFT RIGHT
	M CRM F 450 R	450		2008		F	
	M CRM F 450 X	450		2008		F	

		CC	KW	FROM	TO	FRONT REAR	LEFT RIGHT
	M 450 SMR	450		2007		F	
	M 560 SMR	560		2007		F	

M = MOTORCYCLE
S = SCOOTER
A = ATV
Sn = SNOWMOBILE

FDB2245

77.5 x 50.0 x 8.1 mm

FTE Brake System

MATERIAL AVAILABILITY											
AG	EF	P	PRP	ST	SM	SG	ZR	XRAC	ZRAC	CP1	CPRO
				✓							

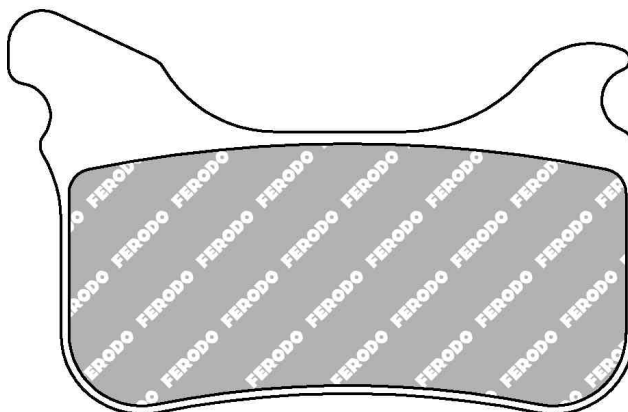
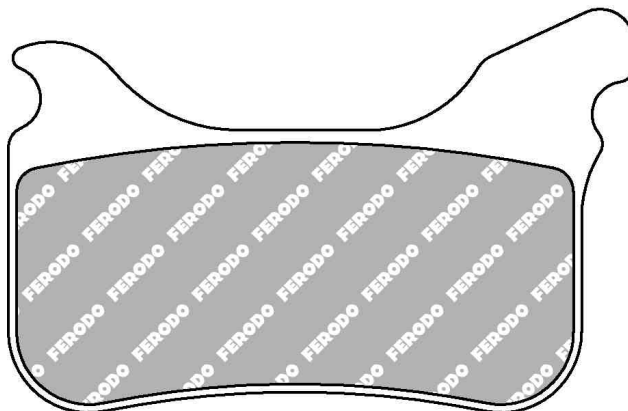

CROSS REFERENCE	
BRAKING	931
BREMBO	07GR75
EBC	FA405
EBC	MXS405
LUCAS/TRW	MCB793
NEWFREN	FD0462
SBS	842
VESRAH	VD-9030

		CC	KW	FROM	TO	FRONT / REAR	LEFT / RIGHT
	M SXV 450	450		2005	2007	F	
	M SXV 550	550		2005		F	
	M PEGASO 650 Factory	650		2008		F	
HUSABERG	M FE 450 c	450		2006		F	

		CC	KW	FROM	TO	FRONT / REAR	LEFT / RIGHT
	M FS 650 e, c	650		2006		F	
	M SX 450 SMR	450		2005	2006	F	
	M SX 525 SMR	525		2005		F	

FDB2248

90.1 x 33.3 x 9.8 mm

July 2018: AG superseded by EF

MATERIAL AVAILABILITY											
AG	EF	P	PRP	ST	SM	SG	ZR	XRAC	ZRAC	CP1	CPRO
	✓										

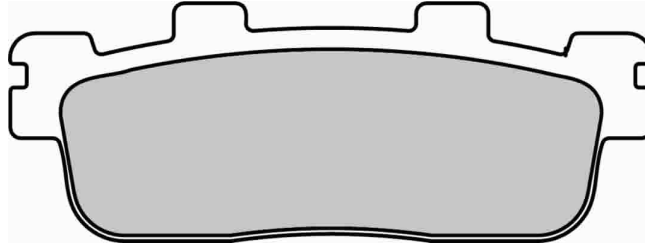

CROSS REFERENCE	
BRAKING	945
BREMBO	07085
BREMBO	7085
BRENTA	3103
BRENTA	4103
EBC	SFA498
GALFER	FD438
GOLD FREN	302
LUCAS/TRW	MCB830
NEWFREN	FD0460
SBS	204
VESRAH	VD-9044

		CC	KW	FROM	TO	FRONT / REAR	LEFT / RIGHT
 KAWASAKI	S J125	125		2016		R	
	S J300	300		2014		R	
KYMCO	S DOWNTOWN 125 i (Super Dink V21000)	125		2009	2011	R	
	S DOWNTOWN 125 i ABS (Super Dink V21000)	125	11	2011	2014	R	
	S DOWNTOWN 125 i ABS	125		2015		R	
	S GRAND DINK 125 E4	125		2016		R	
S PEOPLE S 125 4T (4V)	125		2017		R		

		CC	KW	FROM	TO	FRONT / REAR	LEFT / RIGHT
 S	Racing 125 Fi	125		2010	2015	F	
	M PEOPLE S 150 4T (4V)	150	10	2017		R	
S	Racing 150Fi	150		2010	2014	F	
S	DOWNTOWN 200 i (Super Dink V22000)	200		2010		R	
S	Agility 300	276	17	2019		F	
S	DOWNTOWN 300 i (V2)	300	22	2009	2012	R	
S	DOWNTOWN 300 i ABS (V2)	300	22	2010		R	

M = MOTORCYCLE
S = SCOOTER
A = ATV
Sn = SNOWMOBILE

FDB2250

90.8 x 62.2 x 8.0 mm

N.B. Anti-rattle clips inside caliper pistons must be correctly inserted under back-plate hooks. Do not fit backing shim

MATERIAL AVAILABILITY

AG	EF	P	PRP	ST	SM	SG	ZR	XRAC	ZRAC	CP1	CPRO
				✓							

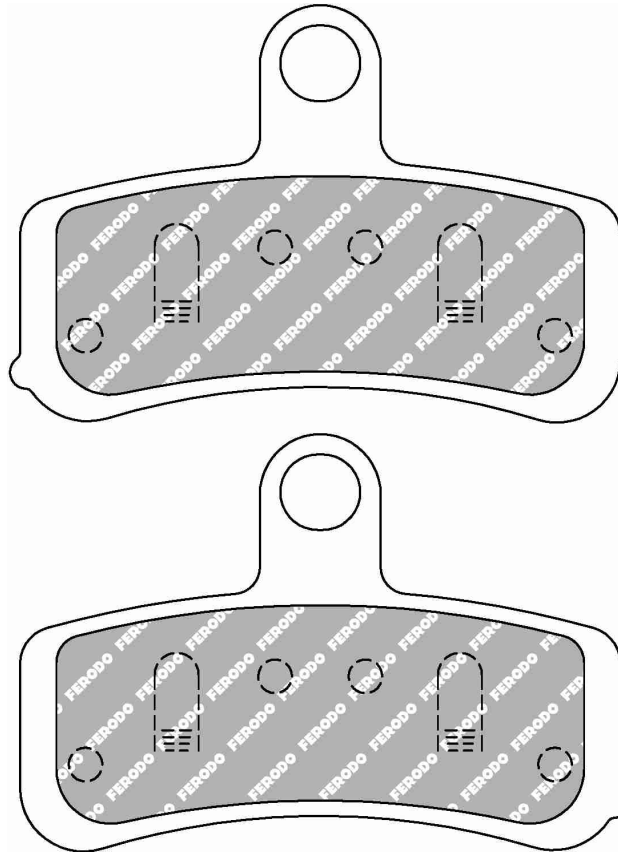

CROSS REFERENCE

BRAKING	943
BREMBO	07HD15
BRENTA	4172
EBC	FA457
LUCAS/TRW	MCB813
NEWFREN	FD0443
SBS	853
VESRAH	VD-9034

		CC	KW	FROM	TO	FRONT / REAR	LEFT / RIGHT
	HARLEY DAVIDSON						
S	FLSTC Heritage Softail Classic	1584		2008	2014	F	
M	FLSTF Fat Boy	1584		2008	2014	F	
M	FLSTFB Fat Boy Special/Lo	1584		2010	2014	F	
M	FLSTFB ANV Fat Boy Lo 110th Ann. Ed.	1584		2013	2013	F	
M	FLSTN Softail Deluxe	1584		2007	2014	F	
M	FXCW Rocker (Cast wheel)	1584		2008	2009	F	
M	FXCWC Rocker C (Cast wheel)	1584		2008	2011	F	
M	FXD Super Glide (Cast wheel)	1584		2008	2010	F	
M	FXDB Street Bob (Spoke wheel)	1584		2008	2013	F	
M	FXDC Dyna Super Glide Custom (Spoke wheels)	1584		2008	2013	F	
M	FXDF Fat Bob	1584		2008		F	
M	FXDL Low Rider	1584		2008		F	
M	FXDWG Wide Glide 105th Ann.	1584		2008	2008	F	
M	FXDWG Wide Glide	1584		2010		F	
M	FXS Blackline	1584		2011	2013	F	
M	FXSTB Night Train (Spoke wheel)	1584		2008	2009	F	

		CC	KW	FROM	TO	FRONT / REAR	LEFT / RIGHT
							
M	FXSTC Softail Custom (Spoke wheel)	1584		2008	2010	F	
M	FXSTI Softail Standard	1584		2008	2014	F	
M	FLD Switchback	1690		2012		F	
M	FLS Softail Slim	1690		2012	2014	F	
M	FLSTC Heritage Softail Classic	1690		2012	2014	F	
M	FLSTFB Fat Boy Special/Lo	1690		2012	2014	F	
M	FLSTF Fat Boy	1690		2012	2014	F	
M	FLSTN Softail Deluxe	1690		2012	2014	F	
M	FXDB Street Bob (Spoke wheel)	1690		2014		F	
M	FXDB Street Bob Special	1690		2016		F	
M	FXDC Dyna Super Glide Custom (Spoke wheel)	1690		2014		F	
M	FXDF Fat Bob	1690		2012		F	
M	FXDL Low Rider	1690		2014		F	
M	FXDWG Wide Glide	1690		2012		F	
M	FXSB Breakout	1690		2013	2014	F	
M	FXDF Fat Bob	1745		2018		F	

FDB2251

127.6 x 52.6 x 7.4 mm

OEM shim should be refitted to non-piston pad

MATERIAL AVAILABILITY											
AG	EF	P	PRP	ST	SM	SG	ZR	XRAC	ZRAC	CP1	CPR0
				✓							

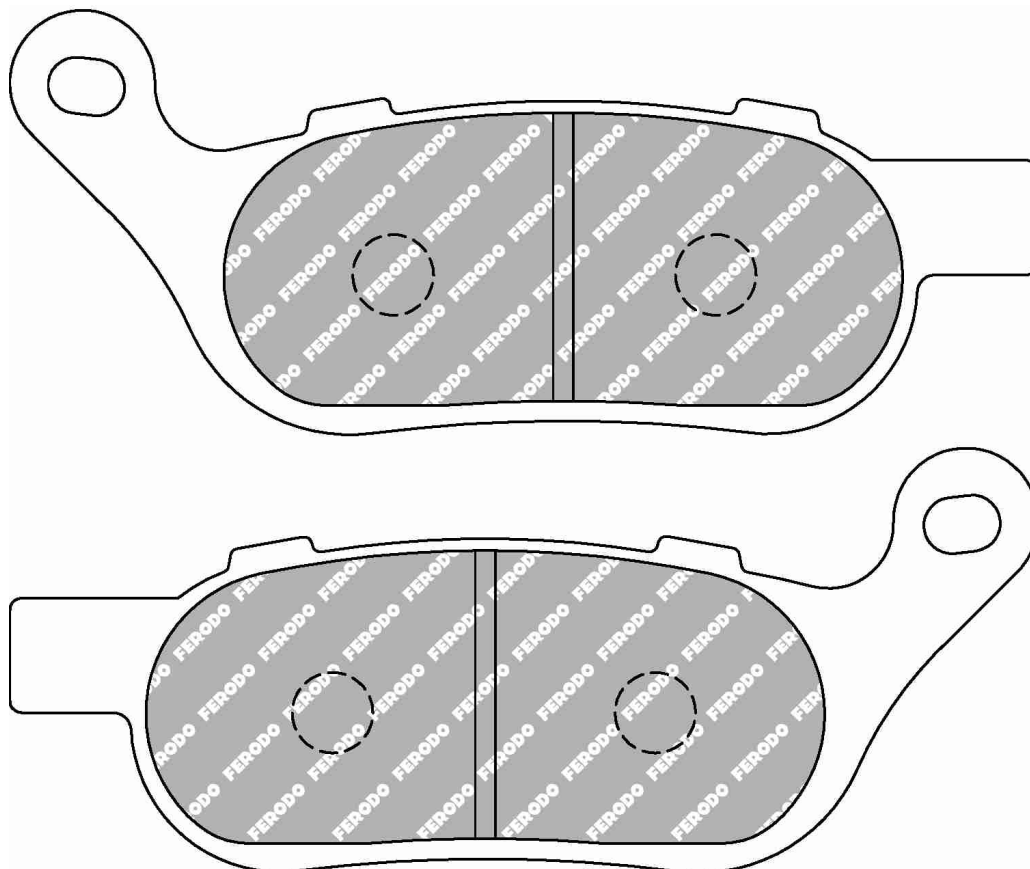



CROSS REFERENCE	
BRAKING	944
BREMBO	07HD07
BRENTA	4163
DP (Dunlop) BRAKE	DP987
EBC	FA458
LUCAS/TRW	MCB814
NEWFREN	FD0436
SBS	854
VESRAH	VD-9035

		CC	KW	FROM	TO	FRONT REAR	LEFT RIGHT
	S FLSTC Heritage Softail Classic	1584		2008	2014	R	
	S FLSTC Heritage Softail Classic	1584		2015	2015	R	
	M FLSTF Fat Boy	1584		2008	2014	R	
	M FLSTFB Fat Boy Special/Lo	1584		2010	2014	R	
	M FLSTFB ANV Fat Boy Lo 110th Ann. Ed.	1584		2013	2013	R	
	M FLSTF Fat Boy	1584		2015		R	
	M FLSTFB Fat Boy Special/Lo	1584		2015		R	
	M FLSTN Softail Deluxe	1584		2007	2014	R	
	M FLSTN Softail Deluxe	1584		2015		R	
	M FLSTSB Softail Cross Bones	1584		2008	2011	R	
	M FXCW Rocker (Cast wheel)	1584		2008	2009	R	
	M FXCWC Rocker C (Cast wheel)	1584		2008	2011	R	
	M FXD Super Glide (Cast wheel)	1584		2008	2010	R	
	M FXDB Street Bob (Spoke wheel)	1584		2008	2013	R	
	M FXDC Dyna Super Glide Custom (Spoke wheels)	1584		2008	2013	R	
	M FXDF Fat Bob	1584		2008		R	
	M FXDL Low Rider	1584		2008		R	
	M FXDWG Wide Glide 105th Ann.	1584		2008	2008	R	
	M FXDWG Wide Glide	1584		2010		R	
	M FXS Blackline	1584		2011	2013	R	

		CC	KW	FROM	TO	FRONT REAR	LEFT RIGHT
	M FXST Softail Standard	1584		2015		R	
	M FXSTB Night Train (Spoke wheel)	1584		2008	2009	R	
	M FXSTC Softail Custom (Spoke wheel)	1584		2008	2010	R	
	M FXSTI Softail Standard	1584		2008	2014	R	
	M FLD Switchback	1690		2012		R	
	M FLS Softail Slim	1690		2012	2014	R	
	M FLS Softail Slim	1690		2015		R	
	M FLSTC Heritage Softail Classic	1690		2012	2014	R	
	M FLSTC Heritage Softail Classic	1690		2015		R	
	M FLSTFB Fat Boy Special/Lo	1690		2012	2014	R	
	M FLSTF Fat Boy	1690		2012	2014	R	
	M FLSTFB Fat Boy Special/Lo	1690		2015		R	
	M FLSTF Fat Boy	1690		2015		R	
	M FLSTN Softail Deluxe	1690		2012	2014	R	
	M FLSTN Softail Deluxe	1690		2015		R	
	M FXDB Street Bob (Spoke wheel)	1690		2014		R	
	M FXDB Street Bob Special	1690		2016		R	
	M FXDC Dyna Super Glide Custom (Spoke wheel)	1690		2014		R	
	M FXDF Fat Bob	1690		2012		R	
	M FXDL Low Rider	1690		2014		R	

M = MOTORCYCLE
S = SCOOTER
A = ATV
Sn = SNOWMOBILE

		CC	KW	FROM	TO	FRONT / REAR	LEFT / RIGHT
	M FXDWG Wide Glide	1690		2012		R	
	M FXSB Breakout	1690		2013	2014	R	
	M FXSB Breakout	1690		2015		R	
	M FLS Softail Slim	1745		2018		R	
	M FLSTC Heritage Softail Classic	1745		2018		R	
	M FLSTF Fat Boy	1745		2018		R	

		CC	KW	FROM	TO	FRONT / REAR	LEFT / RIGHT
	M FXDF Fat Bob	1745		2018		R	
	M FXSB Breakout	1745		2018		R	
	M FLS Softail Slim S	1802		2016		R	
	M FLSTC Heritage Softail Classic	1802		2016		R	
	M FLSTF Fat Boy S	1802		2016		R	

FDB2252

78.5 x 46.5 x 7.5 mm

Road pad ST 7,5mm thick to accommodate original shim [NOT INCLUDED]

MATERIAL AVAILABILITY											
AG	EF	P	PRP	ST	SM	SG	ZR	XRAC	ZRAC	CP1	CPRO
				✓				✗			

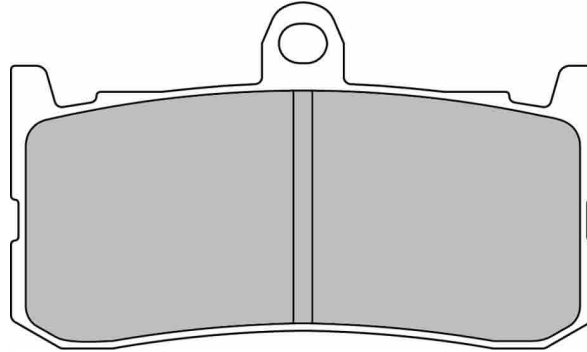

CROSS REFERENCE	
BRAKING	941
BREMBO	07GR06
EBC	FA491
LUCAS/TRW	MCB816
NEWFREN	FD0441
SBS	864
VESRAH	VD-9048

		CC	KW	FROM	TO	FRONT / REAR	LEFT / RIGHT
	TRIUMPH	M	DAYTONA 675	675		2009 2012	F

		CC	KW	FROM	TO	FRONT / REAR	LEFT / RIGHT
	M	DAYTONA 675	675		2013		F

FDB2253

99.6 x 38.4 x 8.9 mm

MATERIAL AVAILABILITY											
AG	EF	P	PRP	ST	SM	SG	ZR	XRAC	ZRAC	CP1	CPRO
				✓							

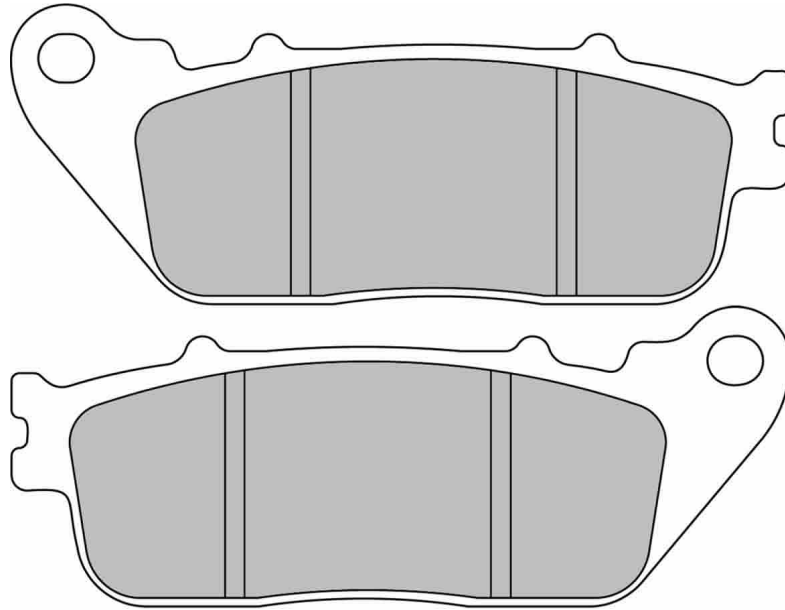

CROSS REFERENCE	
BRAKING	942
BRENTA	3129
BRENTA	4129
EBC	FA488
LUCAS/TRW	MCB817
NEWFREN	FD0446
SBS	862
VESRAH	VD-178

		CC	KW	FROM	TO	FRONT REAR	LEFT RIGHT
	HONDA						
	M	VFR 800 X Crossrunner (RC60)	780		2011	2013	R
	M	VFR 800 XC Crossrunner	800		2012	2014	R
	M	VFR 800 X Crossrunner	800		2015		R

		CC	KW	FROM	TO	FRONT REAR	LEFT RIGHT
	HONDA						
	M	VFR 800 X Crossrunner Travel Edition	800		2015		R
	M	CB 1000 R (No ABS)	1000		2009		R
	M	VFR 1200 FA (Man.Trans.) SC63	1237	127	2009		R

M = MOTORCYCLE
S = SCOOTER
A = ATV
Sn = SNOWMOBILE

FDB2254

94.1 x 36.2 x 10.0 mm

October 2016: AG superseded by EF

MATERIAL AVAILABILITY											
AG	EF	P	PRP	ST	SM	SG	ZR	XRAC	ZRAC	CP1	CPRO
X	✓										

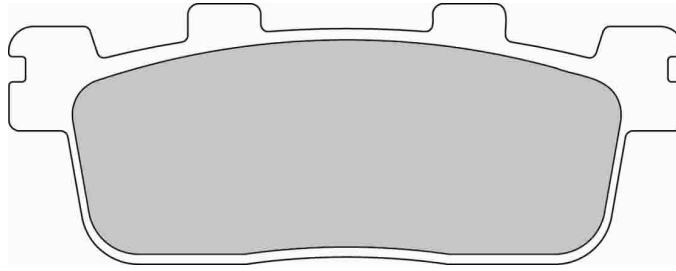

CROSS REFERENCE	
BRAKING	958
BREMBO	07069
BREMBO	7069
EBC	SFA607
GALFER	FD399
GOLD FREN	286
LUCAS/TRW	MCB821
NEWFREN	FD0445
SBS	195
SBS	201
SBS	847
VESRAH	VD-9045

		CC	KW	FROM	TO	FRONT REAR	LEFT RIGHT
	KYMCO						
	S	G-DINK 125i	125		2012		R
	S	K-XCT 125i	125		2012		R
	S	LIKE II 125 i ABS Exclusive	125	6	2017		R
	M	LIKE II 125 i CBS	125	6	2018		R
	S	Like 125 S	125	8	2020		R right
	M	PEOPLE / PEOPLE S 125	125		2006		R
	S	PEOPLE S 125 DD	125		2007		R
	S	PEOPLE GT 125i	125		2010		R
	S	People GT 125 i CBS	125	21	2019		R
	S	X-TOWN 125i ABS	125		2016		R
	S	X-Town CT 125	125	11	2020		R right
	S	PEOPLE S 200 i	200		2007		R
	S	PEOPLE GTi 200	200		2010		R
	M	PEOPLE 250 S	250		2006	2008	R
S	XCITING 250	250		2005	2006	R	

		CC	KW	FROM	TO	FRONT REAR	LEFT RIGHT	
	KYMCO							
	S	XCITING 250	250		2006	2008	R	
	S	Agility 300	276	17	2019		R	
	S	G-DINK 300i	300		2012		R	
	S	G-DINK 300i ABS	300	16	2016		R	
	S	K-XCT 300i /ABS	300		2012		R	
	S	PEOPLE GTi 300	300		2010		R	
	M	PEOPLE S 300 i	300		2018		R	
	S	X-TOWN 300i ABS	300		2016		R	
	S	X-Town CT 300	300	17	2020		R right	
	S	XCITING 300 i	300		2008		R	
	S	XCITING 300 i R	300		2008		R	
	S	DOWNTOWN 350 i ABS	350	22	2015		R	
	YAMAHA	S	X-Max 400 ABS	400	23	2013		R
	S	X-Max 400	400	23	2013		R	
S	X-Max 400RA IRON MAX ABS	400		2016		R		

FDB2255

35.2 x 39.7 x 9.0 mm

4.5 mm Backplate for BMW use only (Set=4 Pads)



MATERIAL AVAILABILITY											
AG	EF	P	PRP	ST	SM	SG	ZR	XRAC	ZRAC	CP1	CPRO
				✓				✓			

ALSO AVAILABLE		
SHAPE	TH. MM	NOTES
FDB2120	7.6	Not for BMW
FDB2215	8.5	Not for BMW

CROSS REFERENCE	
BRAKING	947
BREMBO	07BB33
BRENTA	4122
DP (Dunlop) BRAKE	DP509
EBC	FA604/4HH
GALFER	FD437
GOLD FREN	304
LUCAS/TRW	MCB829
NEWFREN	FD0466
SBS	870

		CC	KW	FROM	TO	FRONT / REAR	LEFT / RIGHT
BMW	M S1000 R Naked (K47)	1000		2014		F	
	M S1000 RR (K46)	1000		2010	2014	F	

		CC	KW	FROM	TO	FRONT / REAR	LEFT / RIGHT
M	S1000 RR	1000	152	2015	2018	F	

FDB2256

111.0 x 44.7 x 8.0 mm / 109.5 x 41.7 x 8.0 mm

July 2016: AG compound superseded by EF

MATERIAL AVAILABILITY											
AG	EF	P	PRP	ST	SM	SG	ZR	XRAC	ZRAC	CP1	CPRO
✗	✓										

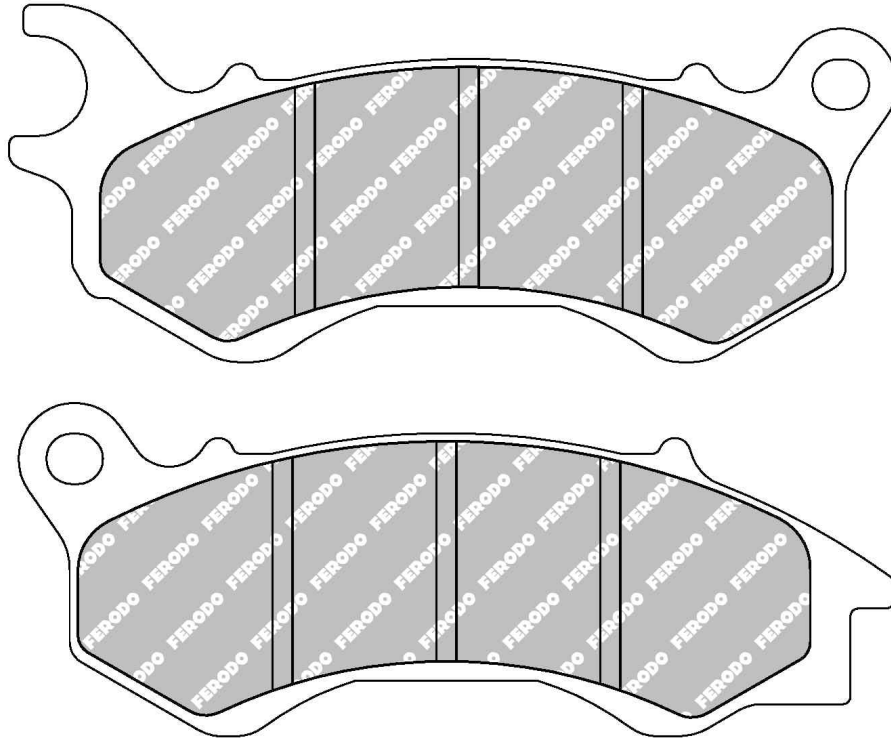

CROSS REFERENCE	
BRAKING	954
BREMBO	07090
BREMBO	7090
BRENTA	3130
BRENTA	4130
EBC	FA603
EBC	SFA603
GALFER	FD439
GOLD FREN	299
LUCAS/TRW	MCB833
NEWFREN	FD0467
SBS	205
VESRAH	VD-180

		CC	KW	FROM	TO	FRONT / REAR	LEFT / RIGHT
	HONDA						
	M NSC 50 C,AC Vision & R	50		2012		F	
	M NSC 110 WHB,AC Vision	110		2011		F	
	M SCV 110 Lead (WHA)	110		2010	2011	F	
	M PCX 125 (WW125 EX2)	125		2010	2013	F	
	M PCX 125 LIMITED EDITION (WW125 EX2)	125		2012		F	
S SH 125 Mode (JF51)	125	8	2014		F		
M PCX 150 (WW150)	150		2012		F		
KYMCO	S AGILITY CITY E4	125		2008		F	
	S AGILITY 125 R16 +	125	7	2015		F	
	S AGILITY Carry 125 (4T) EURO4	125		2017		F	
	S AGILITY City +125 i CBS	125	6	2019		F	
M LIKE II 125 i CBS	125	6	2018		F		

		CC	KW	FROM	TO	FRONT / REAR	LEFT / RIGHT
	PEUGEOT						
	S Like 125 S	125	8	2020		F	left
	S MILER 4T	125		2017		F	
	S PEOPLE ONE 125i	125		2015		F	
	S DJANGO 50 2T (SPORT-EVASION-ALLURE)	50		2015		F	
	S DJANGO 50 4T (SPORT-EVASION-ALLURE)	50		2015		F	
	S DJANGO 125 (ALLURE)	125		2014		F	
	S DJANGO 125 (SPORT)	125		2014		F	
	S DJANGO 125 (EVASION)	125		2014		F	
	S SATELIS 125	125		2013		F	
	S DJANGO 150 (ALLURE)	150		2014		F	
	S DJANGO 150 (SPORT)	150		2014		F	
S DJANGO 150 (EVASION)	150		2014		F		

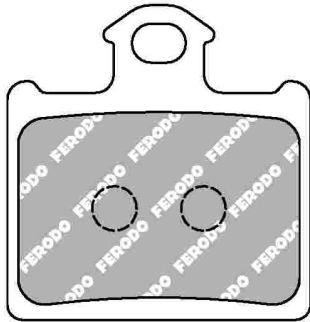

FDB2257

41.0 x 42.4 x 7.3 mm



MATERIAL AVAILABILITY											
AG	EF	P	PRP	ST	SM	SG	ZR	XRAC	ZRAC	CP1	CPRO
						✓					

CROSS REFERENCE	
BRAKING	949
BREMBO	07GR16
BRENTA	4159
EBC	FA602
LUCAS/TRW	MCB831
NEWFREN	FD0464
SBS	872
VESRAH	VD-9063

		CC	KW	FROM	TO	FRONT / REAR	LEFT / RIGHT
	HUSQVARNA						
	M CR 65	65		2010	2013	R	
	M TC 85 (2T/ 17"/14" Wheels)	85		2014		R	
	M TC 85 (2T/ 19"/16" Wheels)	85		2014		R	
	KTM						
	M Freeride Electric			2012		R	
	M Freeride E-XC			2015		R	
	M Freeride E-SX			2015		R	

		CC	KW	FROM	TO	FRONT / REAR	LEFT / RIGHT
	M						
	M Freeride E-SM			2015		R	
	M SX 85 (17"/14")	85		2011		R	
	M SX 85 (16"/19")	85		2012		R	
	M Freeride 250 R	250		2014		R	
	M Freeride 350	350		2012		R	

M = MOTORCYCLE
S = SCOOTER
A = ATV
Sn = SNOWMOBILE

FDB2258

86.0 x 40.0 x 8.9 mm

MATERIAL AVAILABILITY											
AG	EF	P	PRP	ST	SM	SG	ZR	XRAC	ZRAC	CP1	CPR0
	✓			✓							

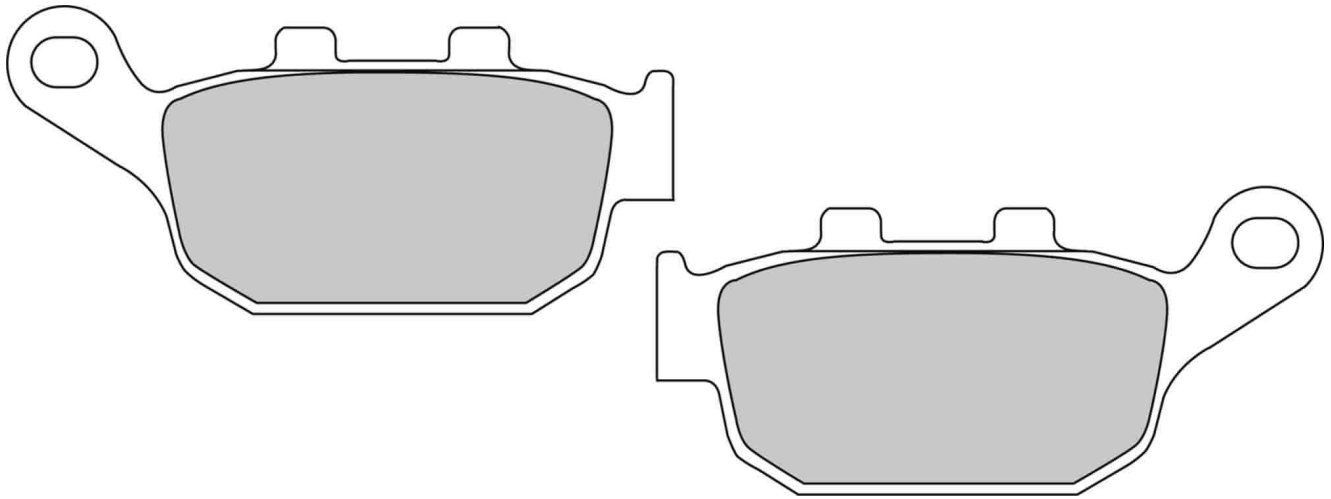

ALSO AVAILABLE		
SHAPE	TH. MM	NOTES
FDB531	10.6	

CROSS REFERENCE	
BRAKING	956
BREMBO	07HO53
BRENTA	3155
BRENTA	4155
EBC	FA496
GALFER	FD457
GOLD FREN	306
LUCAS/TRW	MCB841
NEWFREN	FD0470
SBS	881
VESRAH	VD-147/2

		CC	KW	FROM	TO	FRONT REAR	LEFT RIGHT
AKT	M RTX 150	150				R	
	M AK 250 Adventour	250				R	
HONDA	M CBR 250 R ABS	250		2011		R	
	M CBR 250 R	250		2011		R	
	M CBR300R	300		2014		R	
	M CB 650 R	650	70	2019		R	
	M CB 650 F (RC75)	650	64	2014		R	
	M CBR 650 F	650		2014		R	
	M CTX700N	700		2014		R	
	M CTX700	700		2014		R	
	M NC 750 X Travel Edition	745	40	2018		R	
	S X-ADV	745		2017		R	
	S NC 750 D Integra (RC71)	750	40	2014	2015	R	
	M NC 750 D Integra (RC89)	750	40	2016		R	
	M NC 750 S DCT	750		2014		R	
M NC 750 X (RC72)	750	35	2014	2015	R		
M NC 750 X (RC72)	750	40	2014	2015	R		
M NC 750 X (RC90)	750	40	2016		R		
KAWASAKI	M Versys 650 ABS (LE650E) FFF	650	35	2015		R	
	M Versys 650 (LE650E) EFF	650	35	2015		R	

		CC	KW	FROM	TO	FRONT REAR	LEFT RIGHT	
	M Z 650	650		2017		R		
	M Z 800 (ZR800A)	800	72	2013		R		
	M Z 800 ABS (ZR800B)	800	83	2013		R		
	M Z 800 (ZR800A)	800	78	2013		R		
	M Z 800 (ZR800A)	800	83	2013		R		
	M Z 800 Sugomi Ed.	800		2016		R		
	M Z 800 e (ZR800C)	800	35	2013		R		
	M Z 800 e ABS (ZR800D)	800	70	2013		R		
	M Z 800 e (ZR800C)	800	70	2013		R		
	M Z 900	900		2017		R		
	M Z 900 RS	948	82	2018		R		
	M Z 900 RS Cafe	948	82	2018		R		
	SUZUKI	M GSX 250 R ABS	250		2017		R	
	M Inazuma 250	250		2013		R		
	M Inazuma 250F	250		2015		R		
	M Inazuma 250Z	250		2015		R		
M V-Strom 250 ABS	250		2017		R			
M SV 650 X ABS	645	56	2018		R	right		
M SV 650 ABS	650		2016		R	right		
M SFV GLADIUS 650 NO ABS	650		2009		R			
M SFV GLADIUS 650 ABS	650		2009		R			

FDB2259

69.2 x 51.5 x 8.9 mm / 33.0 x 51.5 x 8.9 mm

Set=4 Pads

MATERIAL AVAILABILITY											
AG	EF	P	PRP	ST	SM	SG	ZR	XRAC	ZRAC	CP1	CPRO
				✓							

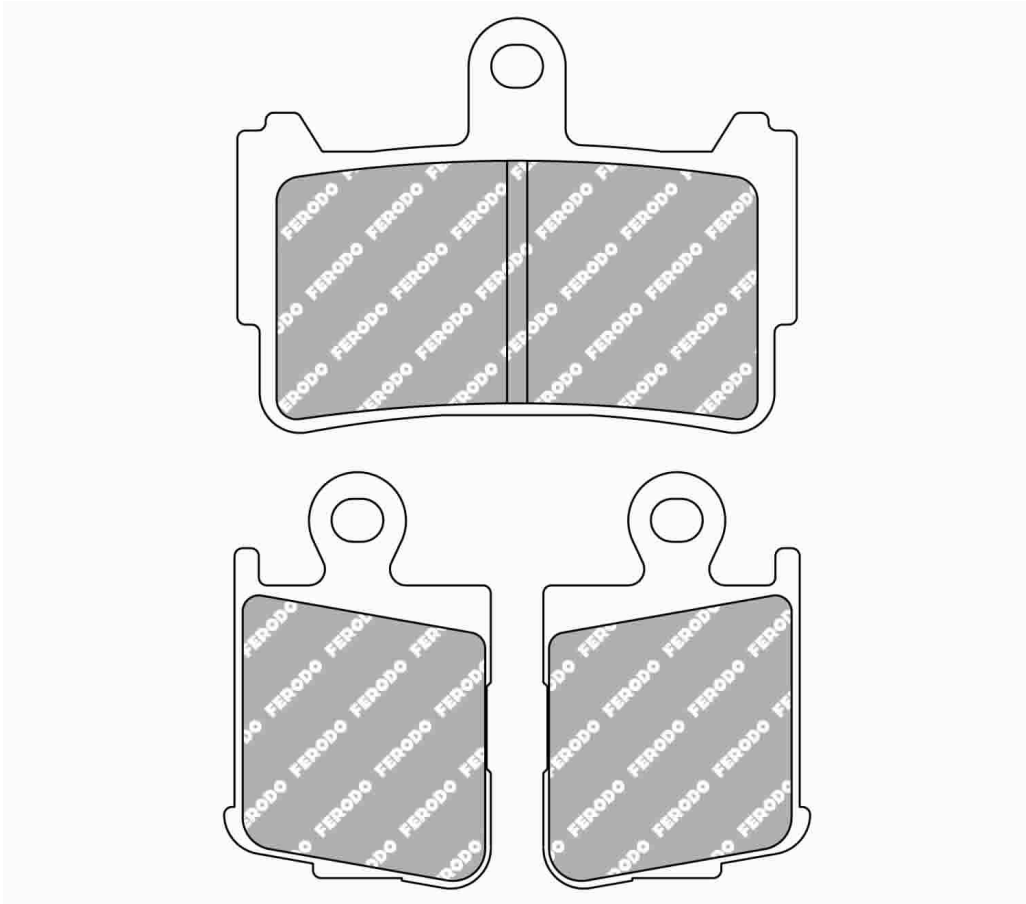

CROSS REFERENCE	
BRAKING	950
BREMBO	07HO37
EBC	FA499/4HH
LUCAS/TRW	MCB828
NEWFREN	FD0491
SBS	869
VESRAH	VD-179



	M	VFR 1200 FA (Man.Trans.) SC63	CC	KW	FROM	TO	FRONT		LEFT	
							REAR	RIGHT	REAR	RIGHT
HONDA			1237	127	2009		F			

M = MOTORCYCLE
S = SCOOTER
A = ATV
Sn = SNOWMOBILE

FDB2260

102.2 x 42.0 x 7.5 mm

CPRO version has 8.0 mm max. thickness; ZRAC superseded by XRAC

MATERIAL AVAILABILITY											
AG	EF	P	PRP	ST	SM	SG	ZR	XRAC	ZRAC	CP1	CPO
				✓				✓			✓

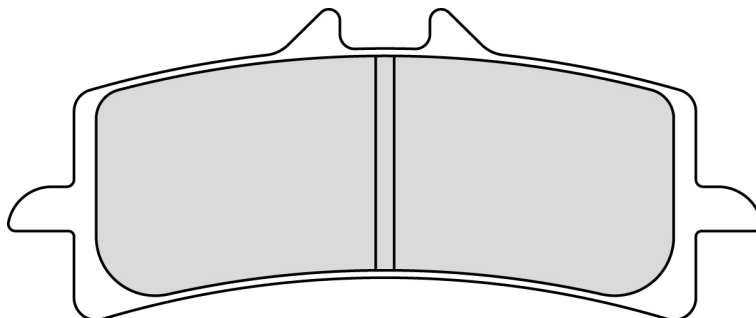

Pinze / Calipers

BREMBO

220.9885.30 High Perf. Kit Ducati models (100 mm distance)

220.A397.10 High Perf. kit Japanese models (108 mm distance)

CROSS REFERENCE

BREMBO	07BB37
BRENTA	4113
CL BRAKES	1185
EBC	FA447
GOLD FREN	258
LUCAS/TRW	MCB792
NEWFREN	FD0415
SBS	841
SBS	901
VESRAH	VD-9031

		CC	KW	FROM	TO	FRONT REAR	LEFT RIGHT
	APRILIA	M	RSV4 Factory /APRC SE /R	1000	2008	F	
	M	RSV4 Factory APRC ABS	1000	2013	F		
	M	RSV4 R APRC ABS	1000	2013	F		
	M	RSV4 RR	1000	2015	F		
	M	RSV4 RF	1000	2016	F		
	M	TUONO V4 RR/Factory	1100	2017	F		
	BENELLI	M	TNT 1130 R	1130	2014	F	
	BIMOTA	M	Tesi 3D Race Cafe'	800	2016	F	
	M	BB3	1000	2014	F		
	M	DB7 Oronero Millenovanotto	1098	2009	F		
	M	DB7 (1099cc)	1099	2009	F		
	M	DB8 (1198cc)	1198	2010	F		
	M	DB8 Oronero	1198	2010	F		
	M	Impeto	1198	2016	F		
	BMW	M	HP4 1000 (K42)	1000	2013	F	
	M	HP4 Race	1000	2019	F		
	M	HP2 Sport 1200	1200	2008	F		
	DUCATI	M	Superbike 848 EVO	848	2011	F	
	M	Panigale V4R	998 162	2019	F		
	M	Desmosedici RR (Lim. Ed.)	1000	2008	F		
	M	1098 /1098 S / 1098 R Bayliss Lim. Ed.	1098	2007	F		
	M	STREETFIGHTER S	1099	2011	F		
	M	HYPERMOTARD 1100S	1100	2007	F		
	M	HYPERMOTARD 1100 SP / EVO SP / Corse ed.	1100	2010	F		
	M	Streetfighter / S	1100	2010	F		
	M	Panigale V4	1103 157	2018	F		
	M	Panigale V4 S	1103 157	2018	F		
	M	Panigale V4 Speciale	1103 157	2018	F		
	M	Panigale V4S Corse	1103 157	2018	F		
	M	Street fighter V4 S	1103 153	2020	F		
	M	1199 Panigale S (ABS Std)	1198	2012	F		
	M	1199 Panigale (ABS Std)	1198	2014	F		
	M	1199 Panigale R (ABS Std)	1198	2013 2017	F		
	M	DIAVEL 1200 (ABS Std)	1198	2011	F		
	M	DIAVEL STRADA 1200 (ABS Std)	1198	2014	F		
	M	DIAVEL DARK 1200 (ABS Std)	1198	2014	F		
	M	DIAVEL CARBON 1200 (ABS Std)	1198	2014	F		
	M	DIAVEL TITANIUM 1200 (ABS Std)	1198	2015	F		
	M	Diavel Diesel	1198 112	2018	F		
	M	MULTISTRADA 1200S	1198	2015	F		
	M	MULTISTRADA 1200S D air	1198	2015	F		
	M	MULTISTRADA 1200 Pikes peak	1198	2016	F		

		CC	KW	FROM	TO	FRONT REAR	LEFT RIGHT
	HONDA	M	SUPERBIKE 1198 / S / S Corse / R / SP	1198	2009	F	
	M	1199 Panigale Superleggera	1199	2014	F		
	M	MONSTER 1200S	1200 108	2014	F		
	M	MONSTER 1200S Stripe	1200	2015	F		
	M	MONSTER 1200R	1200 112	2016	F		
	M	Diavel 1260 S	1262 117	2019	F		
	M	Multistrada 1260 Pikes peak	1262 116	2018	F		
	M	Multistrada 1260 S	1262 116	2018	F		
	M	Multistrada 1260 S D air	1262 116	2018	F		
	M	Multistrada 1260 S Grantour	1262 116	2020	F		
	M	XDIAVEL S	1262	2016	F		
	M	1299 Panigale (ABS Std)	1285	2015	F		
M	1299 Panigale S (ABS Std)	1285	2015	F			
M	1299 Panigale R Final Edition	1285 154	2018	F			
M	1299 Superleggera	1299	2017	F			
M	CBR 1000 RR-R Fireblade SP	1000	2020	F			
M	CBR 1000 RR Fireblade SP	1000 141	2014	F			
M	CBR 1000 RR Fireblade SP-1/SP2	1000	2017	F			
M	RCV 213	1000	2015	F			
	HUSQVARNA	M	FS 450	450	2015	F	
	M	701 VITPILEN	701	2016	F		
	M	NUDA 900	900	2012	F		
M	NUDA 900 ABS	900	2013	F			
	KAWASAKI	M	Ninja HR2 Carbon	998	2017	F	
	M	Ninja H2 SX SE+	998 147	2019	F		
	M	ZX-10RR Ninja	998 149	2017	F		
	M	ZX-10R 1000 SE Ninja	998 149	2018	F		
	M	NINJA H2R	1000 228	2015	F		
	M	NINJA H2	1000 170	2015	F		
	M	NINJA H2 CARBON	1000 170	2017	F		
	M	Z 1000 R Edition	1000	2017	F		
	M	ZX-10R 1000	1000 149	2016	F		
	M	ZX-10R Winter test Ed.	1000	2016	F		
	KTM	M	ZZR 1400 Performance Sport	1400	2016	F	
	M	690 DUKE R (ABS Std)	690	2014	F		
	M	890 Duker	890	2020	F		
	M	990 SMR	990	2010	F		
	M	1190 RC8	1190	2008 2011	F		
	M	1190 RC8 R (ABS Std)	1190	2009	F		
	M	SUPERDUKE R 1290 SP Ed.	1290	2017	F		
	M	SUPERDUKE R 1290 (ABS Std)	1301 130	2014	F		
	M	SUPERDUKE GT 1290	1301 127	2016	F		

		CC	KW	FROM	TO	FRONT REAR	LEFT RIGHT
							
	M SUPERDUKE SE 1290	1301		2016		F	
MOTO GUZZI	M GRANFERRO 1200	1200		2010		F	
	M V12 X / Strada	1200		2010		F	
MV AGUSTA	M F3 675 Oro	675		2012		F	
	M F3 675	675		2015		F	
	M F3 675 WSS	675		2015		F	
	M F3 675 RC	675		2016		F	
	M F3 675 RC Lim.ed.	675	94	2018		F	
	M Superveloce 800	798		2020		F	
	M Superveloce Serie Oro 800	798		2020		F	
	M F3 800	800		2014		F	
	M F3 800 RC	800		2016		F	
	M Brutale 1000 RR	998		2020		F	
	M F4 1000 312R (From VIN #008065)	998		2008	2009	F	
	M F4 1000 S Freccie Tricolori	998		2010	2010	F	
	M F4 1000	998		2010	2015	F	
	M F4 1000 R	998		2012		F	
	M F4 1000 RR	998	148	2012		F	
	M F4 1000 RC	998	151	2015		F	
	M F4 1000 WSBK	998		2015		F	
	M F4 1000 LH44	998	151	2018		F	
	M F4 1000 RC Lim.ed.	998	156	2018		F	
	M F4 1000 Claudio	998		2019		F	
	M Rush 1000	998		2020		F	
	M BRUTALE 1078 RR	1078		2008	2009	F	
	M F4 1078 312 RR	1078		2007	2008	F	

		CC	KW	FROM	TO	FRONT REAR	LEFT RIGHT
							
	M F4 1078 RR	1078		2008	2011	F	
	M BRUTALE 1090 RR	1090		2010		F	
SUZUKI	M GSX-R 600	600		2011		F	
	M GSX-R 750	750		2011		F	
	M GSX-R 1000 No ABS	1000		2012		F	
	M GSX-R 1000 ABS	1000		2015	2019	F	
	M GSX-R 1000 CONCEPT	1000		2016		F	
	M GSX-R 1000 R ABS	1000		2017		F	
	M GSX-S 1000 F ABS	1000		2015		F	
	M GSX-S 1000 ABS	1000		2015		F	
	M GSX-R 1300 HAYABUSA ABS (Brembo Caliper-Road pad)	1300		2013		F	
TRIUMPH	M DAYTONA 675 R	675		2011	2012	F	
	M DAYTONA 675 R	675		2013		F	
	M STREET TRIPLE 765 RS	765		2017		F	
	M SPEED TRIPLE R 1050	1050		2012		F	
	M SPEED TRIPLE R	1050		2016		F	
	M SPEED TRIPLE S	1050		2016		F	
	M Speed Triple RS	1050	110	2019		F	
	M Scrambler 1200 XE	1200	66	2019		F	
	M Scrambler 1200 XC	1200	66	2020		F	
	M THRUXTON R+	1200		2019		F	
	M Thruxton RS	1200	77	2020		F	
	M Thruxton TFC	1200		2020		F	
	M Rocket 3GT	2458	123	2020		F	
	M Rocket 3R	2458	123	2020		F	

FDB2262

59.0 x 40.2 x 7.7 mm

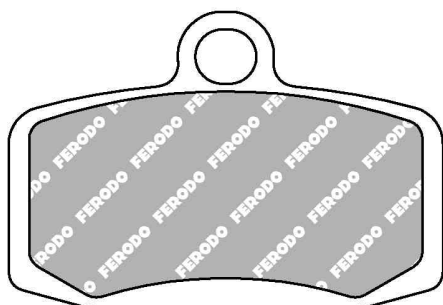



MATERIAL AVAILABILITY

AG	EF	P	PRP	ST	SM	SG	ZR	XRAC	ZRAC	CP1	CPRO
						✓					

CROSS REFERENCE

BRAKING	955
BREMBO	07GR20
BRENTA	4161
DP (Dunlop) BRAKE	DP514
EBC	FA612
GALFER	FD446
LUCAS/TRW	MCB842
NEWFREN	FD0481
SBS	885
VESRAH	VD-9058

		CC	KW	FROM	TO	FRONT REAR	LEFT RIGHT
							
HUSQVARNA	M TC 85 (2T/ 17"/14" Wheels)	85		2014		F	
	M TC 85 (2T/ 19"/16" Wheels)	85		2014		F	
KTM	M Freeride Electric			2012		F	
	M Freeride E-XC			2015		F	
	M Freeride E-SX			2015		F	
	M Freeride E-SM			2015		F	
	M SX 85 (16"/19")	85		2012		F	

		CC	KW	FROM	TO	FRONT REAR	LEFT RIGHT
							
	M Freeride 250 R	250		2014		F	
	M Freeride 350	350		2012		F	
SHERCO	M ST80 (2T)	80		2013	2014	F	
	M ST125 (2T)	125		2013	2014	F	
	M ST250 (2T)	250		2013	2014	F	
	M ST290 (2T)	290		2013	2014	F	
	M ST300 (2T)	300		2013	2014	F	

M = MOTORCYCLE
S = SCOOTER
A = ATV
Sn = SNOWMOBILE

FDB2263**121.0 x 57.3 x 6.9 mm****MATERIAL AVAILABILITY**

AG	EF	P	PRP	ST	SM	SG	ZR	XRAC	ZRAC	CP1	CPRO
						✓					

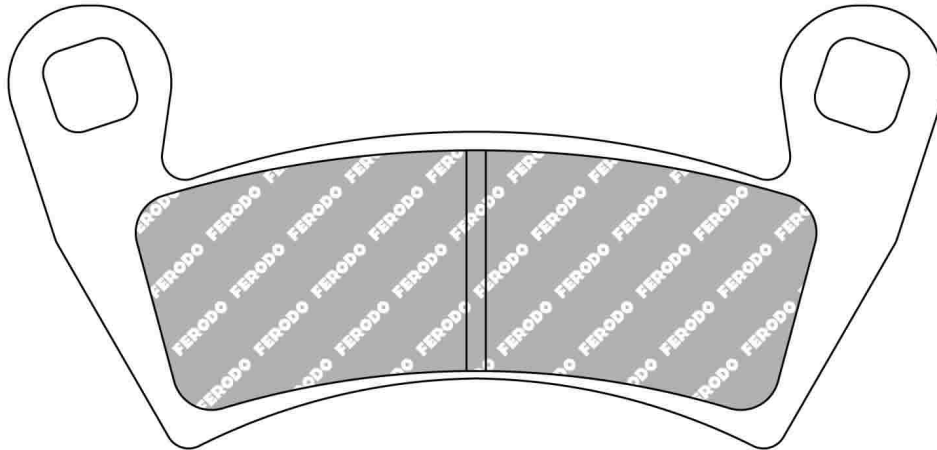
**CROSS REFERENCE**

BREMBO	07PO10
EBC	FA452
EBC	FA656
NEWFREN	FD0492
VESRAH	VD-9036



		CC	KW	FROM	TO	FRONT / REAR	LEFT / RIGHT
POLARIS ATV	A Ranger EV (Electric) - side by side			2010	2011	F	
	A Sportsman ACE 325	325		2014	2014	F	
	A Ranger 400 - side by side	400		2010		F	
	A Ranger 500 4x4 EFI - side by side	500		2008		F	
	A Ranger 500 2x4 - side by side	500		2008		F	
	A Ranger 500 (Carb) 2x4 -side by side	500		2009		F	
	A Ranger 500 (EFI) 4x4 H.O. - side by side	500		2009	2011	F	
	A Ranger 500 Crew - side by side	500		2011		F	
	A Ranger 570 Crew Efi - side by side	570		2014	2015	F	
	A Sportsman ACE 570	570		2015	2015	F	
	A Ranger 700 6x4 EFI - side by side	700		2008		F	
	A Ranger 700 XP 4x4 - side by side	700		2008		F	
	A Ranger 700 4x4 EFI - side by side	700		2009		F	
	A Ranger 700 Crew (EFI) 4x4 - side by side	700		2009		F	
	A Ranger 700 Crew (EFI) 4x4 - side by side	700		2009		R	
	A Ranger 800 HD - side by side	800		2010		F	
	A Ranger 800 XP - side by side	800		2010	2012	F	
	A Ranger 800 6x6 - side by side	800		2010		F	
	A Ranger 800 Crew - side by side	800		2010		F	
	A Ranger 800 RZR-4 EFI - side by side	800		2010		F	



		CC	KW	FROM	TO	FRONT / REAR	LEFT / RIGHT
	A Ranger 800 - side by side	800		2010	2012	F	
	A Ranger 800 RZR-4 EPS - side by side	800		2012	2012	F	
	A Ranger 800 RZR EFI - side by side	800		2013	2014	F	
	A RZR-4 800 - side by side	800		2012	2012	F	
	A Ranger 900 Crew - side by side	900		2010	2015	R	
	A Ranger 900 Crew - side by side	900		2010	2015	F	
	A Ranger 900 D 4x4 Diesel - side by side	900		2011		F	
	A Ranger 900 RZR XP - side by side	900		2011	2012	F	
	A Ranger 900 D Crew - side by side	900		2013	2014	F	
	A Ranger 900 D Crew - side by side	900		2013	2014	R	
	A Polaris Razor XP900 - side by side	900		2012		F	
	A RZR-4 900 XP (EPS Models) - side by side	900		2011	2015	F	
	A RZR-4 900 XP (EPS Models) - side by side	900		2011	2015	R	
	A Ranger 1000 D Crew - side by side	1000		2015	2015	F	
	A Ranger 1000 D- side by side	1000		2015	2015	F	
	A RZR 1000 XP - side by side	1000		2014	2015	F	
	A RZR 1000 XP - side by side	1000		2014	2015	R	
	A RZR XP Turbo	1000		2016		R	
	A RZR XP 4 Turbo	1000		2016		R	

4314**FERODO****RACING**

Updated on November 2020

M = MOTORCYCLE
S = SCOOTER
A = ATV
Sn = SNOWMOBILE

FDB2264

113.7 x 41.7 x 8.8 mm / 109.6 x 51.1 x 9.7 mm

JULY 2018: AG superseded by EF

MATERIAL AVAILABILITY											
AG	EF	P	PRP	ST	SM	SG	ZR	XRAC	ZRAC	CP1	CPRO
✗	✓										

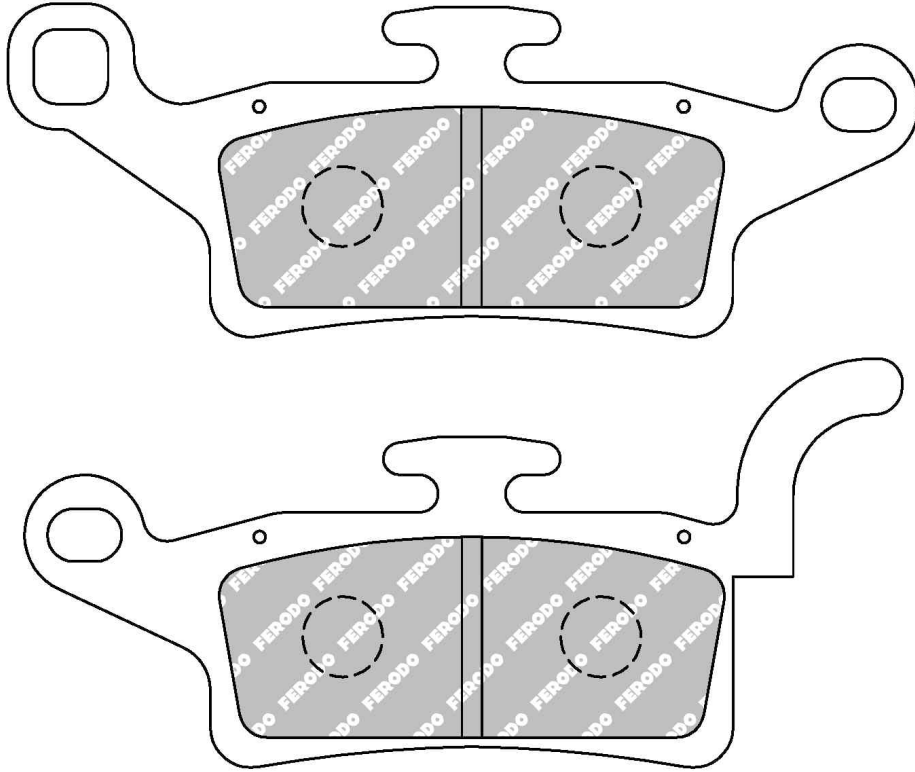

CROSS REFERENCE	
BRAKING	961
BREMBO	07093
BREMBO	7093
BRENTA	3146
BRENTA	4146
EBC	SFA492
GOLD FREN	330
NEWFREN	FD0486
SBS	208
VESRAH	VD-283

		CC	KW	FROM	TO	FRONT REAR	LEFT RIGHT
	MBK						
	M YW 125 Z X-Over	125		2010	2010	F	
	YAMAHA						
	M BW's 125	125		2010		F	

		CC	KW	FROM	TO	FRONT REAR	LEFT RIGHT
	M Xenter 125 (SE59)	125	9	2012		F	
	M Xenter 150	150		2012		F	

M = MOTORCYCLE
S = SCOOTER
A = ATV
Sn = SNOWMOBILE

FDB2265

85.3 x 51.1 x 8.1 mm

MATERIAL AVAILABILITY

AG	EF	P	PRP	ST	SM	SG	ZR	XRAC	ZRAC	CP1	CPRO
	✓			✓							✓

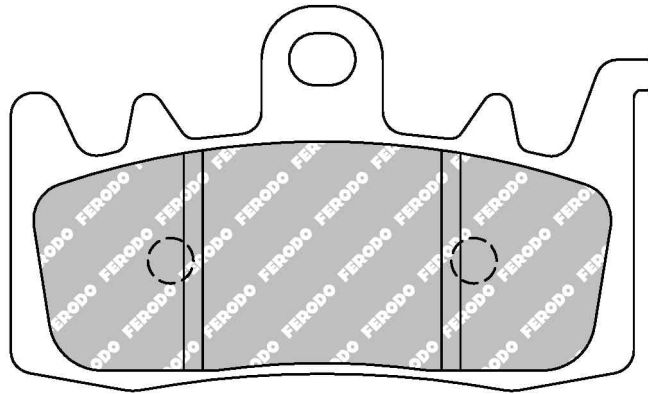
**Pinze / Calipers****BREMBO**

Radial Caliper M4.32

CROSS REFERENCE

BRAKING	960
BREMBO	07BB38
BRENTA	4145
EBC	FA630
GALFER	FD475
GOLD FREN	328
NEWFREN	FD0498
SBS	900
VESRAH	VD-9070

		CC	KW	FROM	TO	FRONT REAR	LEFT RIGHT
	M RS 660	660		2020		F	
	M Tuono 660	660		2020		F	
	M TUONO V4 R APRC ABS	1000		2013		F	
	M TUONO V4 Factory	1078		2015		F	
	M TUONO V4 RR	1078		2015		F	
	M CAPONORD 1200	1200		2013		F	
M CAPONORD 1200 Rally	1200		2015		F		
BENELLI	M BN 600i	600		2014		F	
	M BN 600R	600		2014		F	
	M BN 600GT	600		2015		F	
BMW	M F800 R	800		2015		F	
	M F 900 R	895	77	2020		F	
	M F 900 XR	895	77	2020		F	
	M S1000 XR (K49)	1000	118	2015		F	
	M R nineT (R1ST)	1170	81	2014		F	
	M R nineT (R1ST)	1170	79	2014		F	
	M R 1200 RT (K52)	1200		2014		F	
	M R 1200 R (K53)	1200		2015		F	
	M R 1200 RS	1200		2015		F	
	M R 1200 GS Adventure (K51)	1200	81	2013		F	
	M R 1200 GS (K50)	1200	92	2013		F	
	M R 1200 GS (K50)	1200	79	2013		F	
	M R 1200 GS Exclusive	1200		2017		F	
	M R 1200 GS Rallye	1200		2017		F	
	M R 1250 R	1250	100	2019		F	
M R 1250 RS	1250	100	2019		F		
CAN AM ATV	A Spyder ST (Brembo Calipers)	998		2013		F	
	A Spyder ST - S (Brembo Calipers)	998		2013		F	
	A Spyder ST -LTD (Brembo Calipers)	998		2013		F	
	A Spyder RS (Brembo Calipers)	998		2013		F	
	A Spyder RS-S (Brembo Calipers)	998		2013		F	
	A Spyder RT (Brembo Calipers)	1330		2013		F	
	A Spyder RT-S (Brembo Calipers)	1330		2013		F	
	A Spyder RT - LTD (Brembo Calipers)	1330		2013		F	
	A Spyder RT (3 Cyl Eng/6 Speed)	1330		2014		F	
	A Spyder RT - LTD (3 Cyl Eng/6 Speed)	1330		2014		F	
A Spyder RT-S (3 Cyl Eng/6 Speed)	1330		2014		F		
DUCATI	M Monster 797	803	54	2017		F	
	M Monster 797 plus	803	54	2018		F	
	M SCRAMBLER Icon	803	54	2015		F	
	M SCRAMBLER Urban Enduro	803		2015		F	
	M SCRAMBLER Full Throttle	803	54	2015		F	

		CC	KW	FROM	TO	FRONT REAR	LEFT RIGHT
	M SCRAMBLER Classic (K1)	803	23	2015		F	
	M SCRAMBLER Classic (K1)	803	34	2015		F	
	M SCRAMBLER Classic (K1)	803	55	2015		F	
	M Scrambler Caf	803	54	2017		F	
	M Scrambler Desert Sled	803	54	2017		F	
	M Scrambler Mach 2.0	803	54	2018		F	
	M Scrambler Street Classic	803	54	2018		F	
	M HYPERMOTARD SP 821 (ABS Std)	821		2013		F	
	M HYPERMOTARD 821 (ABS Std)	821		2013		F	
	M HYPERSTRADA 821 (ABS Std)	821		2013		F	
	M MONSTER 821 (M7)	821	35	2015		F	
	M MONSTER 821 DARK	821		2015		F	
	M MONSTER 821 Stripe	821		2015		F	
	M MONSTER 821 (M6)	821	82	2015		F	
	M Monster 821	821	80	2018		F	
	M 899 Panigale (ABS Std)	898		2014		F	
	M HYPERMOTARD 939 SP	937	83	2016		F	
	M HYPERMOTARD 939 (BA)	937	83	2016		F	
	M Hypermotard 950	937	84	2019		F	
	M Hypermotard 950 SP	937	84	2019		F	
	M HYPERSTRADA 939	937	83	2016		F	
	M Multistrada 950	937	83	2017		F	
	M Multistrada 950 S	937	83	2019		F	
	M Supersport S	937	81	2017		F	
	M Supersport	937	81	2017		F	
	M 959 Panigale	955	110	2016		F	
	M 959 Panigale Corse	955	110	2018		F	
	M Panigale V2	955	114	2020		F	
	M Scrambler 1100	1079	63	2018		F	
	M Scrambler 1100 Special	1079	63	2018		F	
	M Scrambler 1100 Sport	1079	63	2018		F	
	M MULTISTRADA 1200 ENDURO	1198	112	2016		F	
M MONSTER 1200	1200	108	2014		F		
M Diavel 1260	1262	117	2019		F		
M Multistrada 1260	1262	116	2018		F		
M Multistrada 1260 Enduro	1262	116	2019		F		
M XDIAVEL	1262		2016		F		
FANTIC	M Caballero Flat Track	500		2017		F	
	M Caballero Scrambler	500		2017		F	
	M Caballero Rally	500		2019		F	
HARLEY DAVIDSON	M Livewire			2020		F	
	M FTR 1200	1200		2019		F	

4316**FERODO****RACING**

Updated on November 2020

M = MOTORCYCLE
S = SCOOTER
A = ATV
Sn = SNOWMOBILE

		CC	KW	FROM	TO	FRONT / REAR	LEFT / RIGHT
	KAWASAKI	M	ZH2	998		2020	F
	KYMCO	S	AK 550	550	39	2017	F
	MV AGUSTA	M	Rivale	800		2013	F
		M	STRADALE 800	800		2015	F
		M	TURISMO VELOCE 800	800	81	2015	F
		M	TURISMO VELOCE 800 LUSO	800	81	2015	F
		M	TURISMO VELOCE 800 POLIZIA	800		2016	F
		M	TURISMO VELOCE RC	800		2017	F
	TRIUMPH	M	STREET TRIPLE 765 R	765		2017	F

		CC	KW	FROM	TO	FRONT / REAR	LEFT / RIGHT
		M	Street Triple 765 R Low	765		2019	F
		M	TIGER EXPLORER Xc	1215		2016	F
		M	TIGER EXPLORER Xca	1215		2016	F
		M	TIGER EXPLORER Xcx	1215		2016	F
		M	TIGER EXPLORER XR	1215		2016	F
		M	TIGER EXPLORER XRt	1215		2016	F
		M	TIGER EXPLORER XRx	1215		2016	F
		M	Rocket 3GT	2458	123	2020	R
		M	Rocket 3R	2458	123	2020	R

FDB2266

69.9 x 45.5 x 8.9 mm

MATERIAL AVAILABILITY											
AG	EF	P	PRP	ST	SM	SG	ZR	XRAC	ZRAC	CP1	CPO
	✓			✓							

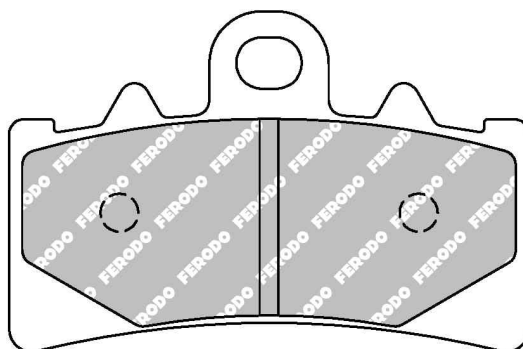

CROSS REFERENCE	
BRAKING	952
BREMBO	07GR18
BRENTA	3154
BRENTA	4154
EBC	FA606
GALFER	FD450
GOLD FREN	305
LUCAS/TRW	MCB834
NEWFREN	FD0497
SBS	877
VESRAH	VD-9068

		CC	KW	FROM	TO	FRONT / REAR	LEFT / RIGHT
	BMW	M	G 310 GS	313		2017	F
		M	G 310 R	313		2016	F
		S	C400	400		2018	F
		S	C 400 GT	400	25	2019	F
	FANTIC	M	Caballero Flat Track	125		2017	F
		M	Caballero Scrambler	125		2017	F
		M	Caballero Flat Track 250	249		2019	F
		M	Caballero Scrambler 250	249		2019	F
	HUSQVARNA	M	401 SVARTPILEN	401		2015	F
		M	401 VITPILEN	401		2015	F
		M	Vitpilen 401 Aero	401		2017	F
		M	Vitpilen 401 TA	401		2017	F

		CC	KW	FROM	TO	FRONT / REAR	LEFT / RIGHT	
	KTM	M	125 DUKE	125	11	2010	2012	F
		M	125 DUKE ABS	125	11	2013		F
		M	RC 125 (ABS Std)	125		2014		F
		M	200 DUKE (ABS Std)	200		2013		F
		M	RC 200 (ABS Std)	200		2014		F
		M	250 DUKE	248	22	2015		F
		M	390 Adventure	390		2020		F left
		M	390 DUKE ABS	390	24	2013		F
		M	390 DUKE ABS	390	30	2013		F
		M	390 DUKE ABS	390	32	2013		F
		M	RC 390 (ABS Std)	390		2014		F

M = MOTORCYCLE
S = SCOOTER
A = ATV
Sn = SNOWMOBILE

FDB2267

36.0 x 42.3 x 5.8 mm

MATERIAL AVAILABILITY											
AG	EF	P	PRP	ST	SM	SG	ZR	XRAC	ZRAC	CP1	CPRO
						✓					

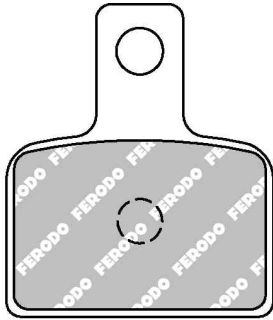

CROSS REFERENCE	
BREMBO	07GR23
EBC	FA495
GALFER	FD428
NEWFREN	FD0496
SBS	895

		CC	KW	FROM	TO	FRONT / REAR	LEFT / RIGHT
 BETA	M EVO 125 2T	125		2009		R	
	M EVO 200 2T	200		2009	2012	R	
	M EVO 250 (2T)	250		2009	2012	R	

		CC	KW	FROM	TO	FRONT / REAR	LEFT / RIGHT
 	M Evo 250 (4T)	250		2009	2012	R	
	M EVO 290 2T	290		2009		R	
	M EVO 300 2T/4T	300		2009	2012	R	

FDB2268

74.6 x 42.0 x 6.5 mm

MATERIAL AVAILABILITY											
AG	EF	P	PRP	ST	SM	SG	ZR	XRAC	ZRAC	CP1	CPRO
		✓									

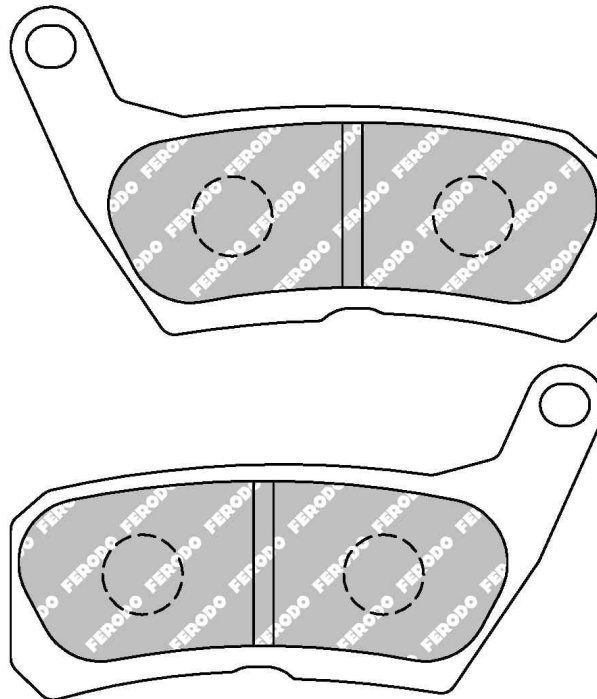

Pinze / Calipers
Magura
 4-Piston Radial Mount

CROSS REFERENCE	
NEWFREN	FD0494

4318

		CC	KW	FROM	TO	FRONT / REAR	LEFT / RIGHT
HONDA-HM ITALIA	M	CRE 50 SIX Comp.	50	2007	2012	F	
	M	CRM 50 Derapage Comp.	50	2007	2012	F	
	M	CRE 125 SIX Comp.	125	2010	2011	F	

		CC	KW	FROM	TO	FRONT / REAR	LEFT / RIGHT
M	CRM 125 2T Derapage Comp.	125		2011	2012	F	
	CRM 125 4T Derapage Comp.	125		2011	2012	F	

FDB2270

62.1 x 40.9 x 7.1 mm

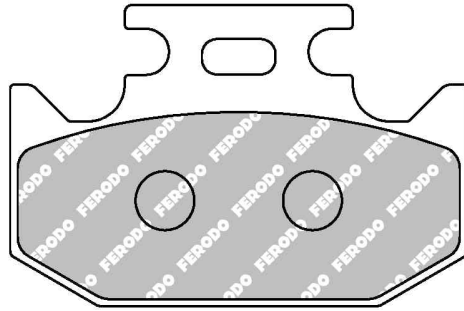

MATERIAL AVAILABILITY											
AG	EF	P	PRP	ST	SM	SG	ZR	XRAC	ZRAC	CP1	CPRO
		✓									

ALSO AVAILABLE

SHAPE	TH. MM	NOTES
FDB659	9.4	

		CC	KW	FROM	TO	FRONT / REAR	LEFT / RIGHT
YAMAHA ATV	A	YXR 700 RHINO 4X4 SE (Parking brake)	700		2009	F	

		CC	KW	FROM	TO	FRONT / REAR	LEFT / RIGHT
A	YXR 700 FA/FB/FD RHINO Side x Side (Parking brake)	700		2011	2013	F	

CROSS REFERENCE	
EBC	FA497
NEWFREN	FD0492

FDB2271

67.6 x 52.1 x 7.5 mm

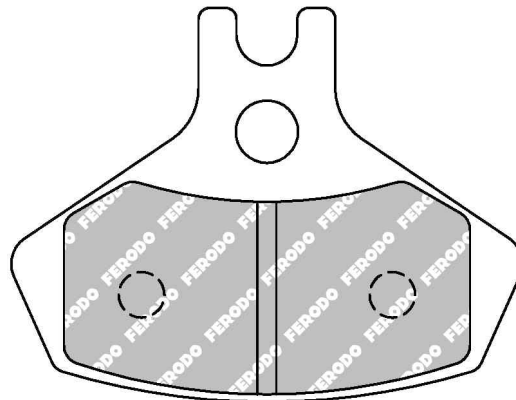

MATERIAL AVAILABILITY											
AG	EF	P	PRP	ST	SM	SG	ZR	XRAC	ZRAC	CP1	CPRO
						✓					

CROSS REFERENCE	
BREMBO	07GR22
EBC	FA468
NEWFREN	FD0504
VESRAH	VD-9059

		CC	KW	FROM	TO	FRONT / REAR	LEFT / RIGHT
CAN AM ATV	A	DS 450 (2x4/EFi)	450	2008	2012	F	
	A	DS 450 X (2x4/EFi)	450	2008	2009	F	

		CC	KW	FROM	TO	FRONT / REAR	LEFT / RIGHT
	A	DS 450 Xxc/Xxm	450	2009	2012	F	

FDB2272

95.5 x 40.0 x 6.1 mm

MATERIAL AVAILABILITY											
AG	EF	P	PRP	ST	SM	SG	ZR	XRAC	ZRAC	CP1	CPRO
						✓					

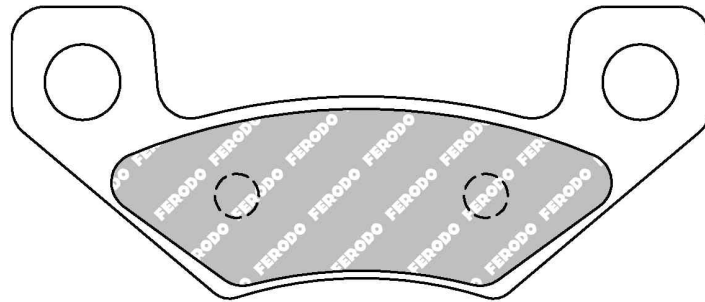

CROSS REFERENCE	
BREMBO	07GR25
EBC	FA398
NEWFREN	FD0503

		CC	KW	FROM	TO	FRONT / REAR	LEFT / RIGHT
CAN AM ATV	A	DS 450 (2x4/EFi)	450	2008	2012	R	
	A	DS 450 X (2x4/EFi)	450	2008	2009	R	
	A	DS 450 Xxc/Xxm	450	2009	2012	R	
JOHN DEERE ATV	A	4PX Gator 4x2/4x4 4x4 Trail 9345		2004	2005	F	
	A	4PX Gator 4x2/4x4 4x4 Trail 9345		2004	2005	R	
	A	HPX Gator 4x2/4x4 9446		2004	2008	F	
	A	HPX Gator 4x2/4x4 9446		2004	2008	R	
	A	HPX 4 x2 (Petrol) Gater		2010	2011	F	
	A	HPX 4 x2 (Petrol) Gater		2010	2011	R	

		CC	KW	FROM	TO	FRONT / REAR	LEFT / RIGHT
	A	HPX 4 x4 / 4 x 4 Trail (Petrol) - Gator		2010	2011	F	
	A	HPX 4 x4 / 4 x 4 Trail (Petrol) - Gator		2010	2011	R	
	A	HPX 4x4 (Diesel) - Gator - (SN040000)		2010		F	
	A	HPX 4x4 (Diesel) - Gator - (SN040000)		2010		R	
	A	TX Gater Utility 9461		2004	2005	F	
	A	TX Gater Utility 9461		2004	2005	R	
	A	TX Turf Gator 9462		2004	2005	F	
	A	TX Turf Gator 9462		2004	2005	R	

FDB2273

109.1 x 39.3 x 7.6 mm / 95.7 x 36.3 x 7.6 mm

MATERIAL AVAILABILITY											
AG	EF	P	PRP	ST	SM	SG	ZR	XRAC	ZRAC	CP1	CPRO
						✓					

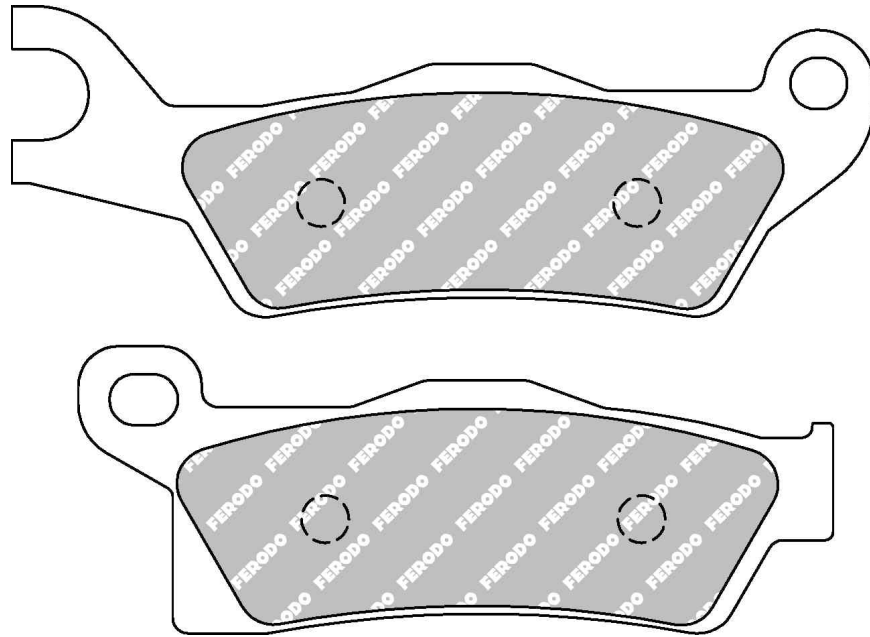

CROSS REFERENCE	
BREMBO	07GR26
EBC	FA617
NEWFREN	FD0505
VESRAH	VD-9061

		CC	KW	FROM	TO	FRONT REAR	LEFT RIGHT
	CAN AM ATV						
A	Outlander 500 4 x 4 (STD/DPS/XT)	500		2013		F	right
A	Outlander 500 4 x 4 (STD/DPS/XT)	500		2013		R	
A	Outlander Max 500 4 x 4 (STD/DPS/XT)	500		2013		F	right
A	Outlander Max 500 4 x 4 (STD/DPS/XT)	500		2013		R	
A	Renegade 500 (STD)	500		2012	2013	F	right
A	Renegade 500 (STD)	500		2012	2013	R	
A	Outlander 650 4 x 4 (STD/DPS/XT)	650		2013		F	right
A	Outlander 650 4 x 4 (STD/DPS/XT)	650		2013		R	
A	Outlander 800 R STD	800		2012		F	right
A	Outlander 800 R STD	800		2012		R	
A	Outlander 800 R XT	800		2012	2013	F	right
A	Outlander 800 R XT	800		2012	2013	R	
A	Outlander 800 R 4 x 4 (STD/DPS/XT/XT-P)	800		2013		F	right
A	Outlander 800 R 4 x 4 (STD/DPS/XT/XT-P)	800		2013		R	
A	Renegade 800 R STD	800		2012	2013	F	right
A	Renegade 800 R STD	800		2012	2013	R	
A	Renegade 800 R Xxc	800		2012	2013	F	right

		CC	KW	FROM	TO	FRONT REAR	LEFT RIGHT
							
A	Renegade 800 R Xxc	800		2012	2013	R	right
A	Outlander 1000 STD	1000		2012	2013	F	right
A	Outlander 1000 STD	1000		2012	2013	R	right
A	Outlander 1000 4 x 4 (DPS/XT/XT-P)	1000		2013		F	right
A	Outlander 1000 4 x 4 (DPS/XT/XT-P)	1000		2013		R	
A	Outlander 1000 4 x 4 (LTD)	1000		2013		F	right
A	Outlander 1000 4 x 4 (LTD)	1000		2013		R	
A	Outlander 1000 4 x 4 (XMR)	1000		2013		F	right
A	Outlander 1000 4 x 4 (XMR)	1000		2013		R	
A	Outlander 1000 XT	1000		2013		F	right
A	Outlander 1000 XT	1000		2013		R	right
A	Outlander Max 1000 4 x 4 (DPS/XT/XT-P)	1000		2013		F	right
A	Outlander Max 1000 4 x 4 (DPS/XT/XT-P)	1000		2013		R	
A	Renegade 1000 STD	1000		2013		F	right
A	Renegade 1000 STD	1000		2013		R	right
A	Renegade 1000 Xxc	1000		2013		F	right
A	Renegade 1000 Xxc	1000		2013		R	right

M = MOTORCYCLE
S = SCOOTER
A = ATV
Sn = SNOWMOBILE

FDB2274

109.1 x 39.3 x 7.6 mm / 95.7 x 36.3 x 7.6 mm

MATERIAL AVAILABILITY											
AG	EF	P	PRP	ST	SM	SG	ZR	XRAC	ZRAC	CP1	CPRO
						✓					

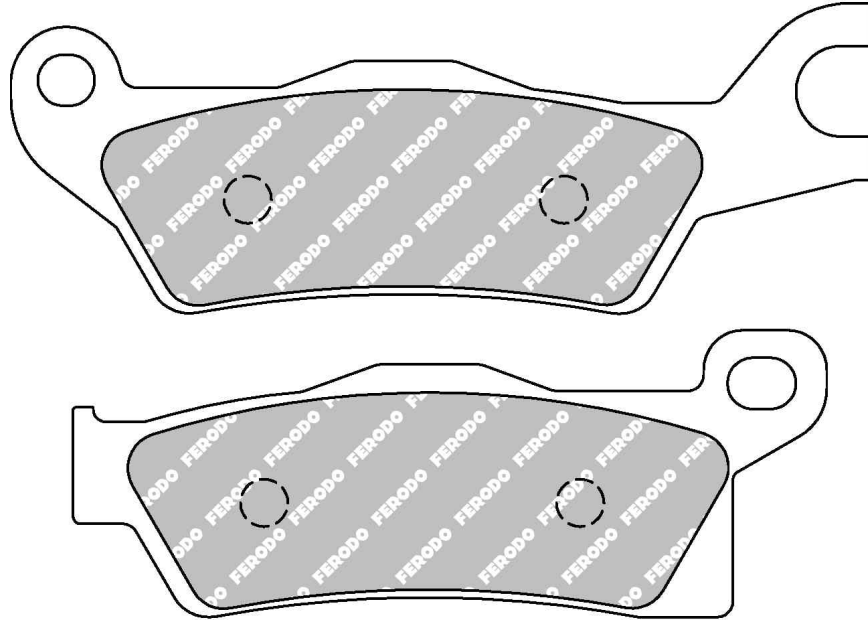

CROSS REFERENCE	
BREMBO	07GR27
EBC	FA618
NEWFREN	FD0506
VESRAH	VD-9062

		CC	KW	FROM	TO	FRONT / REAR	LEFT / RIGHT
	CAN AM ATV						
	A Outlander 500 4 x 4 (STD/DPS/XT)	500		2013		F	left
	A Outlander Max 500 4 x 4 (STD/DPS/XT)	500		2013		F	left
	A Renegade 500 (STD)	500		2012	2013	F	left
	A Outlander 650 4 x 4 (STD/DPS/XT)	650		2013		F	left
	A Outlander 800 R STD	800		2012		F	left
	A Outlander 800 R XT	800		2012	2013	F	left
	A Outlander 800 R 4 x 4 (STD/DPS/XT/XT-P)	800		2013		F	left
	A Renegade 800 R STD	800		2012	2013	F	left
	A Renegade 800 R Xxc	800		2012	2013	F	left
A Renegade 800 R Xxc	800		2012	2013	R	left	
A Outlander 1000 STD	1000		2012	2013	F	left	

		CC	KW	FROM	TO	FRONT / REAR	LEFT / RIGHT
	A Outlander 1000 STD	1000		2012	2013	R	left
	A Outlander 1000 4 x 4 (DPS/XT/XT-P)	1000		2013		F	left
	A Outlander 1000 4 x 4 (LTD)	1000		2013		F	left
	A Outlander 1000 4 x 4 (XMR)	1000		2013		F	left
	A Outlander 1000 XT	1000		2013		F	left
	A Outlander 1000 XT	1000		2013		R	left
	A Outlander Max 1000 4 x 4 (DPS/XT/XT-P)	1000		2013		F	left
	A Renegade 1000 STD	1000		2013		F	left
	A Renegade 1000 STD	1000		2013		R	left
	A Renegade 1000 Xxc	1000		2013		F	left
A Renegade 1000 Xxc	1000		2013		R	left	

FDB2275

88.1 x 40.0 x 10.0 mm

MATERIAL AVAILABILITY

AG	EF	P	PRP	ST	SM	SG	ZR	XRAC	ZRAC	CP1	CPRO
	✓	✓									

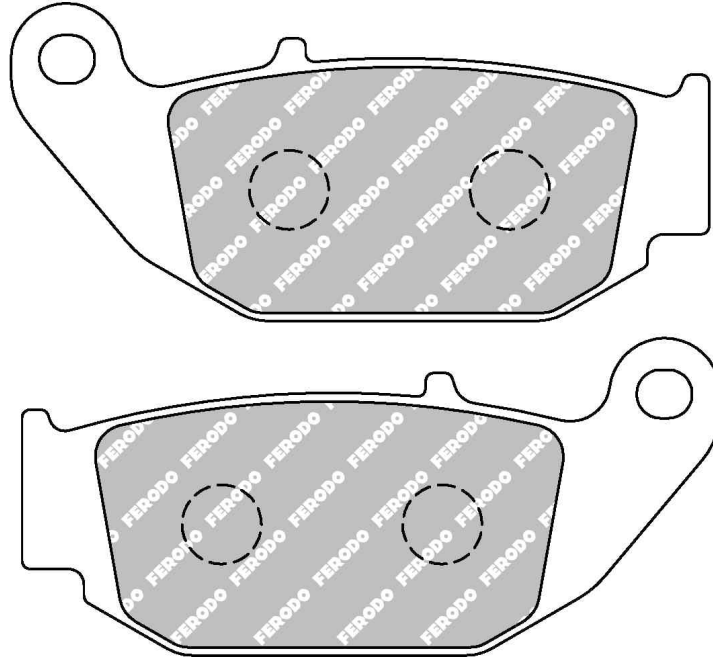

CROSS REFERENCE

BRAKING	965
BREMBO	07HO61
BRENTA	3151
BRENTA	4151
EBC	FA629
GOLD FREN	311
NEWFREN	FD0502
SBS	915
VESRAH	VD-182

		CC	KW	FROM	TO	FRONT / REAR	LEFT / RIGHT
	M CB 125 R	125	10	2018		R	
	M CBR 125 R	125		2011	2016	R	
	M MSX 125	125	7,2	2017		R	
	M CRF 250 LD	250	18	2013		R	
	M CRF 250 M Supermoto	250		2014		R	
M CRF 250 Rallye	250	18	2015		R		

		CC	KW	FROM	TO	FRONT / REAR	LEFT / RIGHT
	M CB 300 R	300	23	2018		R	
	M GSX-R 125 ABS	125		2016		R	
	M GSX-S 125 ABS	125		2016		R	
	M GSX-R 150 ABS	150		2017		R	
M GSX-S 150 ABS	150		2017		R		

M = MOTORCYCLE
S = SCOOTER
A = ATV
Sn = SNOWMOBILE

FDB2276

96.9 x 43.3 x 6.9 mm

MATERIAL AVAILABILITY

AG	EF	P	PRP	ST	SM	SG	ZR	XRAC	ZRAC	CP1	CPRO
						✓					

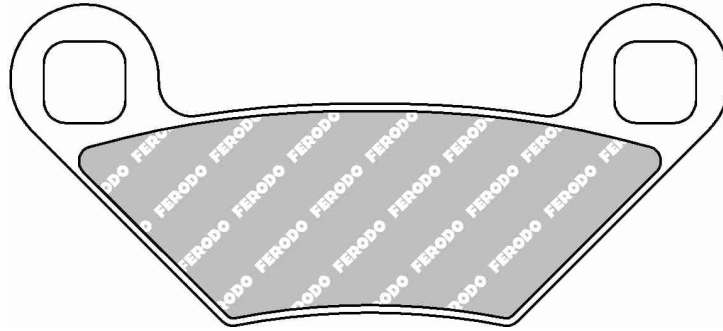

CROSS REFERENCE

BREMBO	07PO11
EBC	FA475
NEWFREN	FD0513



		CC	KW	FROM	TO	FRONT REAR	LEFT RIGHT
POLARIS ATV	A XP Sportsman 500	500		2009		F	
	A XP Sportsman 500	500		2009		R	
	A Sportsman EPS 550	550		2010	2012	F	
	A Sportsman EPS 550	550		2010	2012	R	
	A Sportsman Forest 550	550		2010	2012	F	
	A Sportsman Forest 550	550		2010	2012	R	
	A Sportsman X2 550	550		2010	2011	F	
	A Sportsman X2 550	550		2010	2011	R	
	A Sportsman Touring EPS 550	550		2010	2012	F	
	A Sportsman Touring EPS 550	550		2010	2012	R	
	A Sportsman X2 550	550		2010		F	
	A Sportsman X2 550	550		2010		R	
	A Sportsman 550	550		2011	2012	F	
	A Sportsman 550	550		2011	2012	R	
	A XP Sportsman EPS 500	550		2009	2011	F	
	A XP Sportsman EPS 500	550		2009	2011	R	
	A Sportsman Forest 800	800		2012		F	
	A Sportsman Forest 800	800		2012		R	



		CC	KW	FROM	TO	FRONT REAR	LEFT RIGHT
	A Scrambler 850	850		2015	2015	F	
	A Scrambler 850	850		2015	2015	R	
	A Sportsman Touring EPS 850	850		2010	2012	F	
	A Sportsman Touring EPS 850	850		2010	2012	R	
	A Sportsman Forest 850	850		2012		F	
	A Sportsman Forest 850	850		2012		R	
	A Sportsman 850 XP H.O. EPS	850		2013	2015	F	
	A Sportsman 850 XP H.O. EPS	850		2013	2015	R	
	A XP Sportsman 850	850		2009	2012	F	
	A XP Sportsman 850	850		2009	2012	R	
	A XP EPS Sportsman 850	850		2009	2013	F	
	A XP EPS Sportsman 850	850		2009	2013	R	
	A Forest 1000	1000		2015	2015	F	
	A Forest 1000	1000		2015	2015	R	
	A Scrambler 1000XP	1000		2015	2015	F	
	A Scrambler 1000XP	1000		2015	2015	R	
	A Sportsman 1000 MD/XP	1000		2015	2015	F	
	A Sportsman 1000 MD/XP	1000		2015	2015	R	

FDB2277

55.5 x 49.3 x 6.8 mm

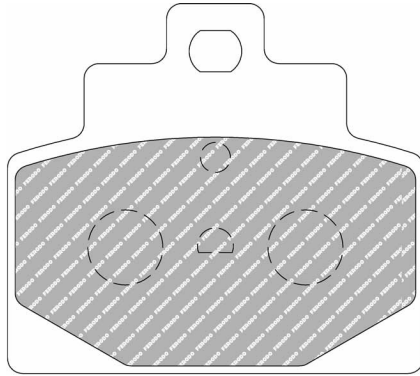

MATERIAL AVAILABILITY											
AG	EF	P	PRP	ST	SM	SG	ZR	XRAC	ZRAC	CP1	CPRO
✓											

CROSS REFERENCE	
BREMBO	7109
EBC	FA681
GALFER	FD343
NEWFREN	FD0510

		CC	KW	FROM	TO	FRONT REAR	LEFT RIGHT
 PIAGGIO	S MP3 300 ie LT Sport ABS	300		2014		F	
	S MP3 300 ie LT Business ABS	300		2014		F	
	S MP3 350	330		2018		F	
	S MP3 500 i.e. LT Business ABS/ASR	500		2014		F	

		CC	KW	FROM	TO	FRONT REAR	LEFT RIGHT
	S MP3 500 i.e. Sport ABS/ASR	500		2014		F	
	S MP3 500 Business HPE	500	41	2018		F	
	S MP3 500 Sport HPE	500	41	2018		F	

FDB2278

94.1 x 33.8 x 9.5 mm

World SBK, British SBK and TT race

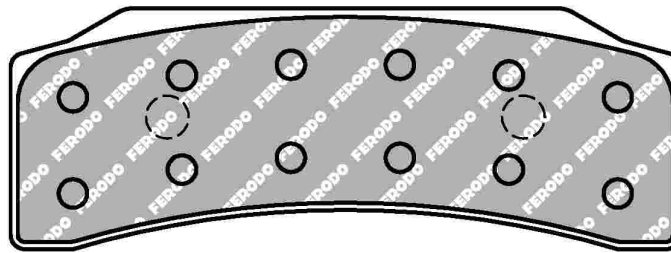

MATERIAL AVAILABILITY											
AG	EF	P	PRP	ST	SM	SG	ZR	XRAC	ZRAC	CP1	CPRO
								✓	✓		

Pinze / Calipers

BREMBO

SBK Racing DX XB0.B1.31, SX XB0.B1.30 (P4 30/34)

CROSS REFERENCE	
BREMBO	07.B366.90
SBS	889

FDB2279

80.1 x 44.5 x 8.8 mm

MATERIAL AVAILABILITY											
AG	EF	P	PRP	ST	SM	SG	ZR	XRAC	ZRAC	CP1	CPRO
✓											

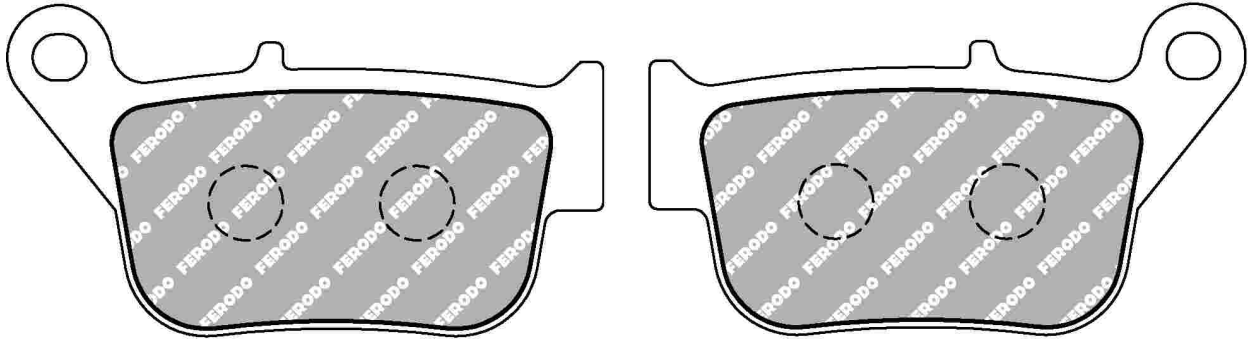

CROSS REFERENCE	
BRENTA	3150
BRENTA	4150
EBC	FA678
NEWFREN	FD0514

		CC	KW	FROM	TO	FRONT / REAR	LEFT / RIGHT
	YAMAHA	S	YP 125 R X-MAX (Nissin Front) NO ABS	125		2014	R

		CC	KW	FROM	TO	FRONT / REAR	LEFT / RIGHT
	S	X-Max 250 (SG22)	250		2014	R	

FDB2280

113.6 x 55.3 x 8.4 mm / 99.1 x 44.8 x 8.4 mm

MATERIAL AVAILABILITY

AG	EF	P	PRP	ST	SM	SG	ZR	XRAC	ZRAC	CP1	CPRO
	✓			✓						✓	✓

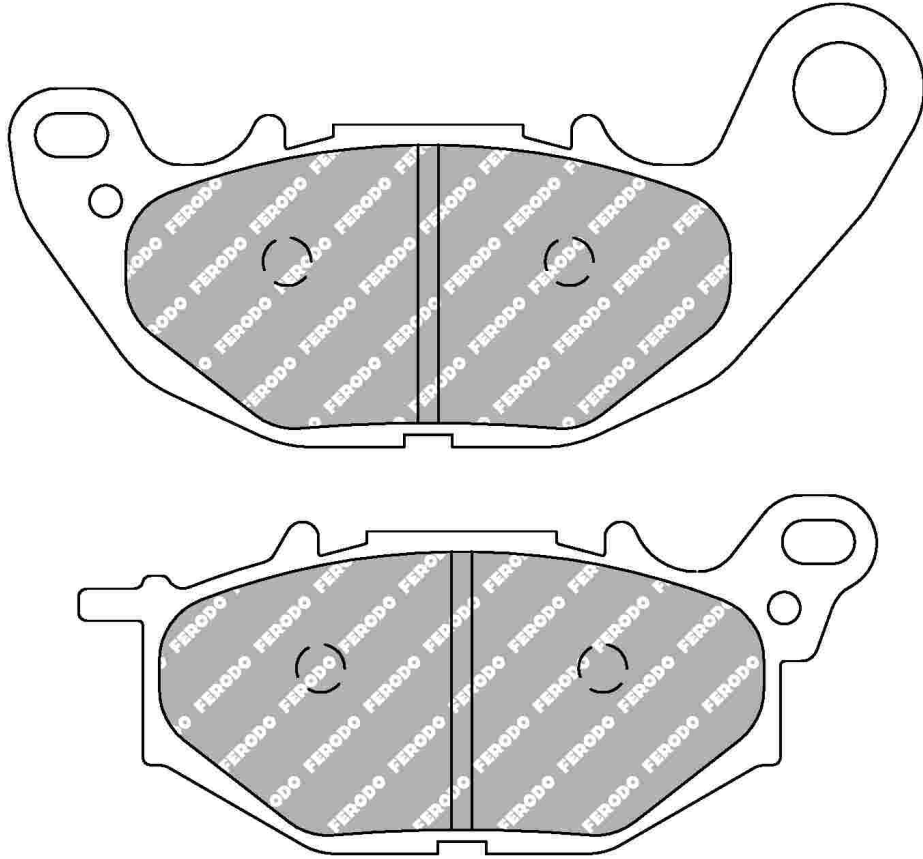

CROSS REFERENCE

BREMBO	07YA52
EBC	FA663
NEWFREN	FD0515
SBS	931
VESRAH	VD-289

		CC	KW	FROM	TO	FRONT / REAR	LEFT / RIGHT
 YAMAHA	S X-Max 125 ABS	124		2018		F	
	M YZF-R25 (RG10)	250	26	2015		F	
	S X-Max 300 Iron Max	300	20	2019		F	

		CC	KW	FROM	TO	FRONT / REAR	LEFT / RIGHT
 YAMAHA	S X-Max 300 ABS	300		2017		F	
	M MT-03 ABS	321		2016		F	
	M YZF-R3	321		2015		F	

M = MOTORCYCLE
S = SCOOTER
A = ATV
Sn = SNOWMOBILE

FDB2281

102.1 x 40.1 x 9.4 mm

MATERIAL AVAILABILITY

AG	EF	P	PRP	ST	SM	SG	ZR	XRAC	ZRAC	CP1	CPRO
				✓							

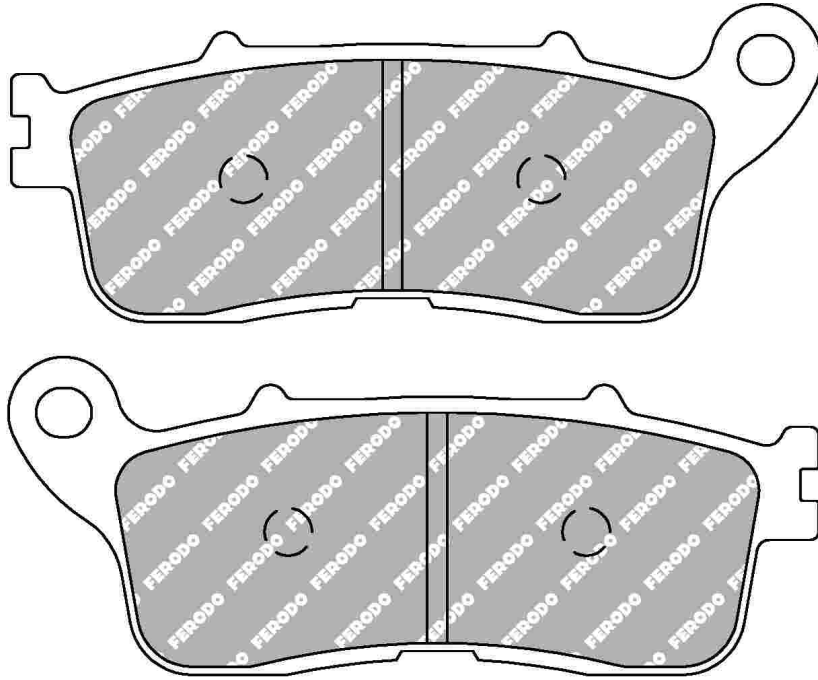

CROSS REFERENCE

BRACING	957
BREMBO	07HO60
DP (Dunlop) BRAKE	DP506
EBC	FA636HH
LUCAS/TRW	MCB848
NEWFREN	FD0500
SBS	892
VESRAH	VD-185

		CC	KW	FROM	TO	FRONT / REAR	LEFT / RIGHT
	HONDA						
	M VFR 1200 FA (Man.Trans.) SC63	1237	127	2009		R	
	M VFR 1200 XA Crosstourer (Man.Tras.) SC70	1237	95	2012		R	

		CC	KW	FROM	TO	FRONT / REAR	LEFT / RIGHT
	HONDA						
	M VFR 1200 XD-DCT Crosstourer (Autom. Transm.) SC70	1237	95	2012		R	
	M VFR 1200 X Crosstourer	1237		2016		R	

FDB2282

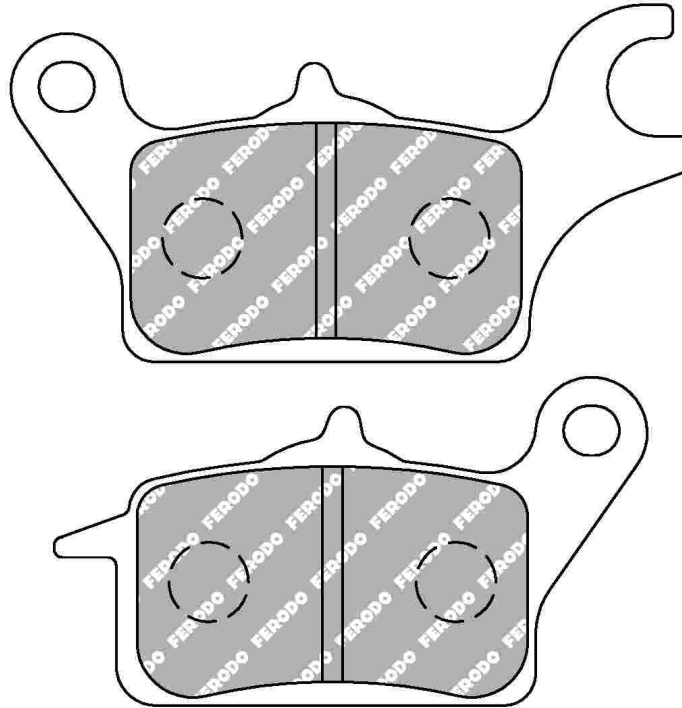

85.1 x 44.9 x 7.3 mm / 74.5 x 41.3 x 7.3 mm

MATERIAL AVAILABILITY											
AG	EF	P	PRP	ST	SM	SG	ZR	XRAC	ZRAC	CP1	CPR0
	✓										



ALSO AVAILABLE		
SHAPE	TH. MM	NOTES
FDB2296	9	

CROSS REFERENCE	
BREMBO	07102
BREMBO	7102
EBC	SFA625
GOLD FREN	336
NEWFREN	FD0519
SBS	216
VESRAH	VD-186

		CC	KW	FROM	TO	FRONT REAR	LEFT RIGHT			CC	KW	FROM	TO	FRONT REAR	LEFT RIGHT
	HONDA	S	AFS 110 Wave (2SHC)	110	2012	F			S	Super Cub C125	125	2019	F		

M = MOTORCYCLE
S = SCOOTER
A = ATV
Sn = SNOWMOBILE

FDB2283

97.0 x 40.1 x 10.7 mm / 113.3 x 52.4 x 10.7 mm

MATERIAL AVAILABILITY

AG	EF	P	PRP	ST	SM	SG	ZR	XRAC	ZRAC	CP1	CPRO
	✓	✗									

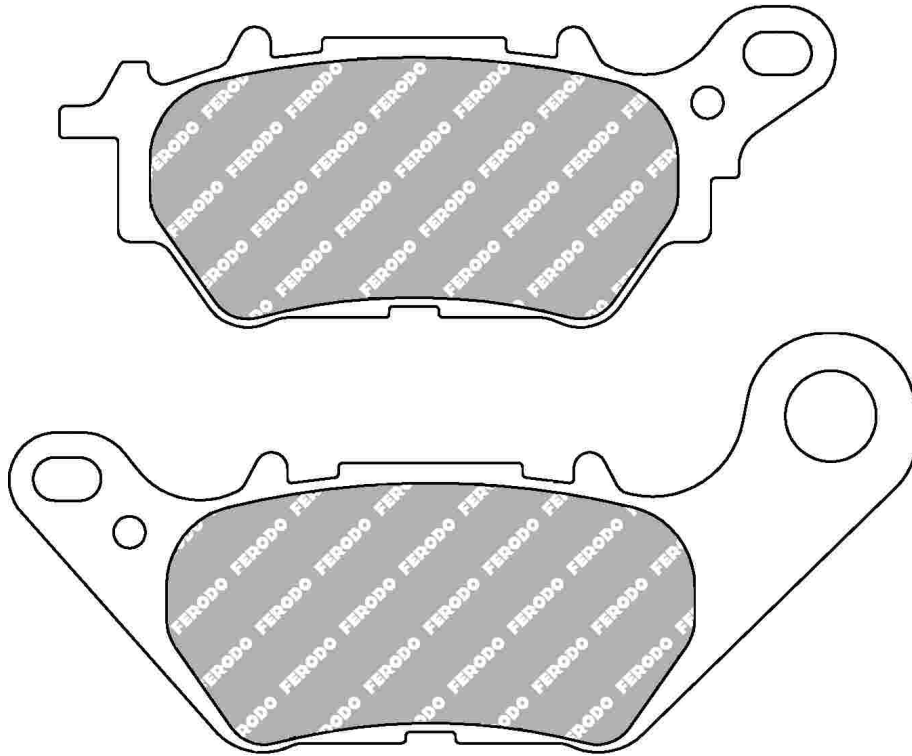

CROSS REFERENCE

BREMBO	07YA53
EBC	FA662
NEWFREN	FD0516
SBS	932
VESRAH	VD-290

		CC	KW	FROM	TO	FRONT / REAR	LEFT / RIGHT
YAMAHA	S	X-Max 125 ABS	124		2018	R	
	M	YZF-R25 (RG10)	250	26	2015	R	
	S	X-Max 300 ABS	300		2017	R	

		CC	KW	FROM	TO	FRONT / REAR	LEFT / RIGHT
M	MT-03 ABS	321		2016		R	
	YZF-R3	321		2015		R	

FDB2284

90.1 x 39.1 x 10.2 mm

MATERIAL AVAILABILITY											
AG	EF	P	PRP	ST	SM	SG	ZR	XRAC	ZRAC	CP1	CPRO
	✓										

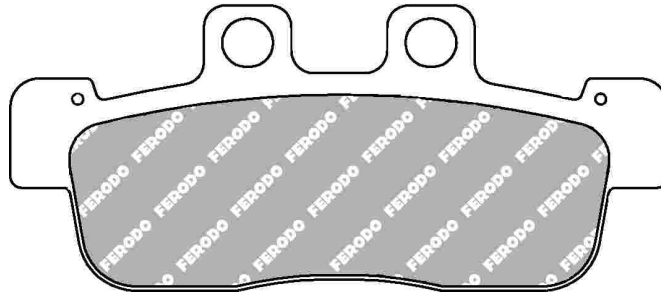

CROSS REFERENCE	
BREMBO	07092
BREMBO	7092
BRENTA	3153
BRENTA	4153
EBC	SFA632
GOLD FREN	363
NEWFREN	FD0487
SBS	207
VESRAH	VD-281

		CC	KW	FROM	TO	FRONT / REAR	LEFT / RIGHT
YAMAHA	S	NXC 125 K CYGNUS X Cab (HC6-1)	125		2007	2010	F
	S	NXC 125 K CYGNUS X Injection (4C6-2)	125		2007	2010	F

		CC	KW	FROM	TO	FRONT / REAR	LEFT / RIGHT
	S	YW 125 X (1DN1/2)	125		2010	2013	F

FDB2285

45.4 x 54.7 x 7.3 mm

MATERIAL AVAILABILITY											
AG	EF	P	PRP	ST	SM	SG	ZR	XRAC	ZRAC	CP1	CPRO
	✓										

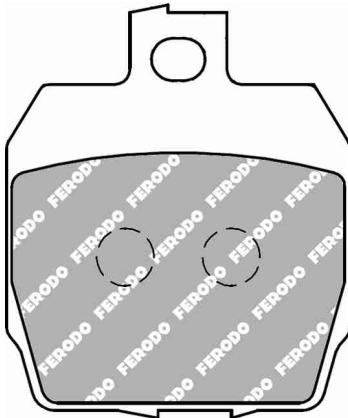

		CC	KW	FROM	TO	FRONT / REAR	LEFT / RIGHT
BAJAJ	M	Pulsar 220 DTS Fi	220	15	2006		R
	M	Pulsar 220	220		2007	2009	R

		CC	KW	FROM	TO	FRONT / REAR	LEFT / RIGHT
	M	Pulsar 220 S DTSi	220	15	2010		R
	M	Pulsar 220 F	220	15	2011		R

M = MOTORCYCLE
S = SCOOTER
A = ATV
Sn = SNOWMOBILE

FDB2286

93.2 x 40.0 x 10.6 mm

MATERIAL AVAILABILITY											
AG	EF	P	PRP	ST	SM	SG	ZR	XRAC	ZRAC	CP1	CPRO
	✓										

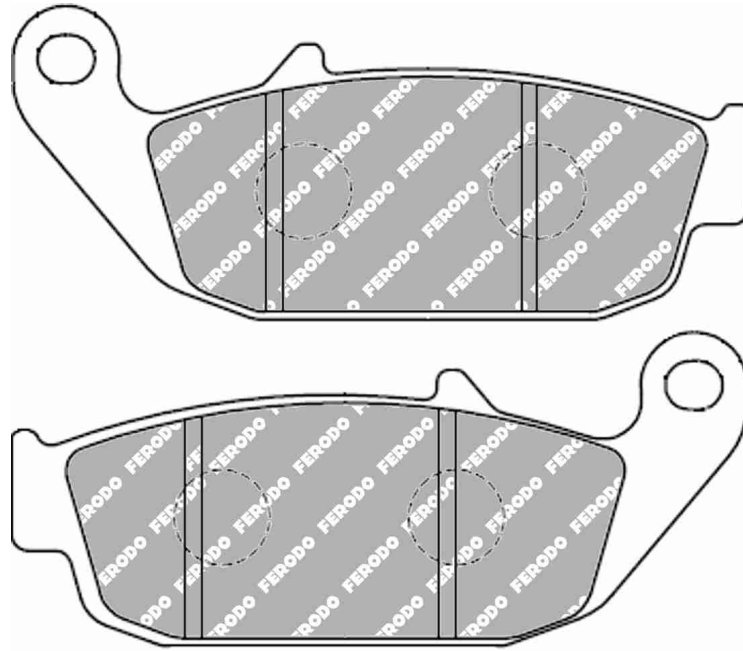

		CC	KW	FROM	TO	FRONT REAR	LEFT RIGHT
AKT	M TTR 180	180				R	
	M TTX 180	180				R	
TVS	M Apache RTR 160 Hyper Edge	160	11	2010		R	

		CC	KW	FROM	TO	FRONT REAR	LEFT RIGHT
	M Apache RTR	180				R	
	M Apache RTR	200				R	

FDB2287

110 x 39 x 8.3 mm / 94.0 x 36.0 x 8.3 mm

MATERIAL AVAILABILITY											
AG	EF	P	PRP	ST	SM	SG	ZR	XRAC	ZRAC	CP1	CPRO
	✓										

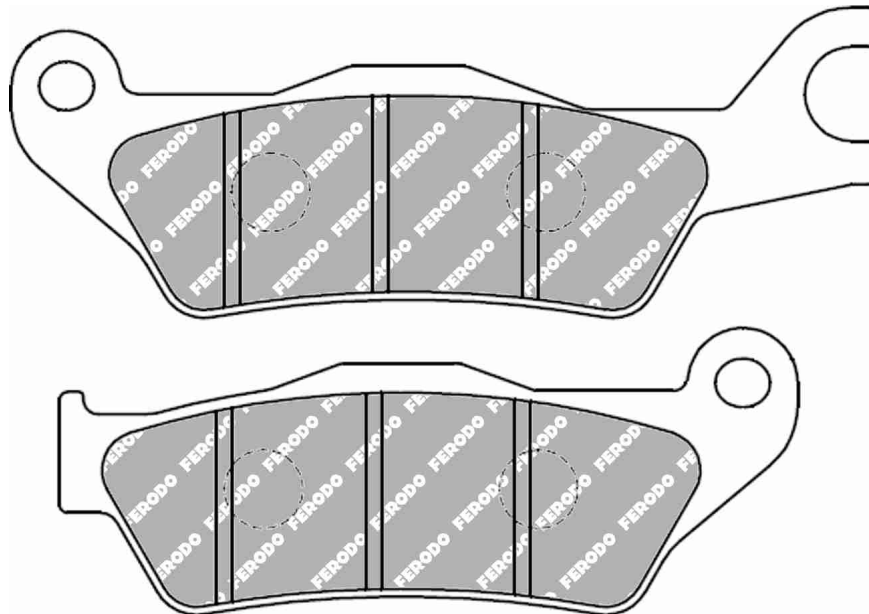

CROSS REFERENCE	
VESRAH	VD-360

		CC	KW	FROM	TO	FRONT / REAR	LEFT / RIGHT
HERO	M	Passion Pro TR	97	6	2014	F	
	M	Passion Pro	97	6	2016	F	
	M	Passion XPro	109	7	2012	F	
	M	Passion XPro	109	6	2016	F	
	M	Passion Plus	110		2012	F	

		CC	KW	FROM	TO	FRONT / REAR	LEFT / RIGHT
SUZUKI	M	GSX-R 125 ABS	125		2016	F	
	M	GSX-S 125 ABS	125		2016	F	
	M	GSX-R 150 ABS	150		2017	F	
	M	GSX-S 150 ABS	150		2017	F	

FDB2288

102 x 39 x 10.5 mm

With Parking brake Pin

MATERIAL AVAILABILITY											
AG	EF	P	PRP	ST	SM	SG	ZR	XRAC	ZRAC	CP1	CPRO
	✓										

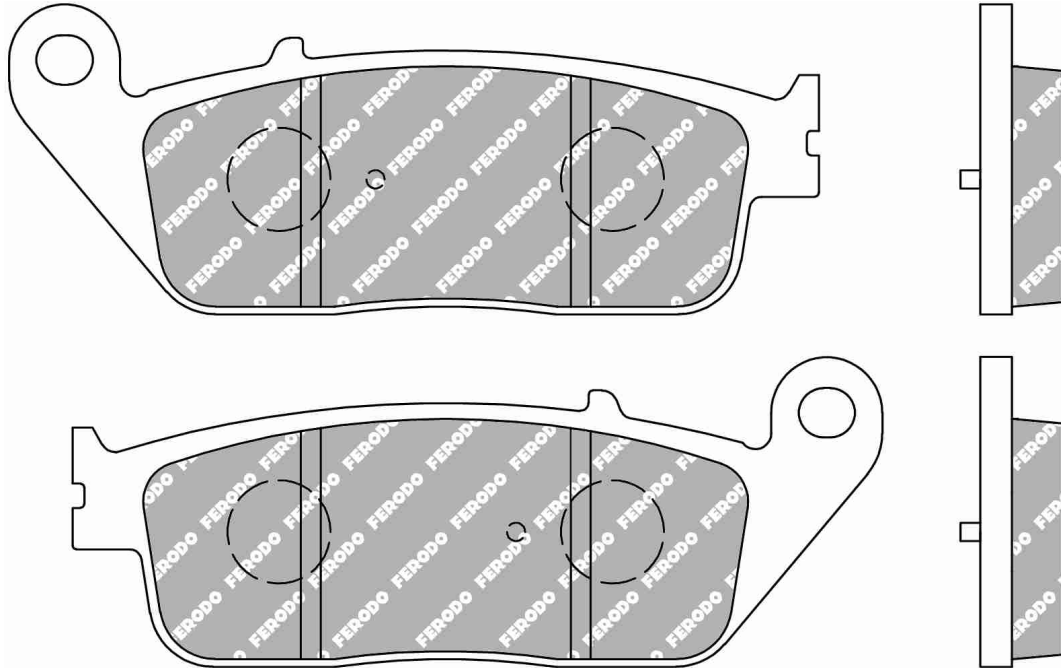

ALSO AVAILABLE		
SHAPE	TH. MM	NOTES
FDB570	8.3	Without Pin
FDB664	9.8	Without Pin
FDB2225	10.3	Without Pin

CROSS REFERENCE	
EBC	SFA608
GOLD FREN	333
NEWFREN	FD0422
SBS	212

		CC	KW	FROM	TO	FRONT / REAR	LEFT / RIGHT
KYMCO	S	XCITING 400 i	400	26	2013	R	
	S	XCITING 400 i ABS	400		2014	R	
	S	XCITING 400 i R	400		2015	R	
	M	XCITING 400 i S	400	26	2018	R	
	S	XCITING 500 (T70000)	500		2005	R	

		CC	KW	FROM	TO	FRONT / REAR	LEFT / RIGHT
	S	XCITING 500 i (T20020)	500		2006	2008	R
	S	XCITING 500 i R (T70030)	500		2007		R
	S	XCITING 500 Ri (T70021)	500		2009		R
	S	XCITING 500 i EVO ABS	500		2012		R
	S	MYROAD 700	700		2009		R

M = MOTORCYCLE
S = SCOOTER
A = ATV
Sn = SNOWMOBILE

FDB2289

85.1 x 44.9 x 7.3 mm / 74.5 x 41.3 x 7.3 mm

MATERIAL AVAILABILITY											
AG	EF	P	PRP	ST	SM	SG	ZR	XRAC	ZRAC	CP1	CPRO
	✓										

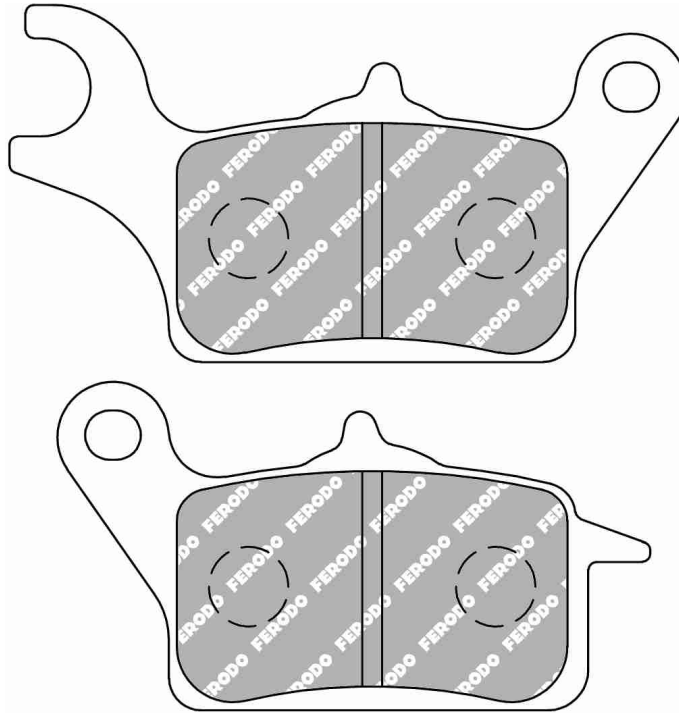

ALSO AVAILABLE		
SHAPE	TH. MM	NOTES
FDB2297	9	

				CC	KW	FROM	TO	FRONT / REAR	LEFT / RIGHT
	S	VISION		110		2017	2018	F	
	S	Zoomer X		110		2013		F	

				CC	KW	FROM	TO	FRONT / REAR	LEFT / RIGHT
	S	Click 125i		125		2012	2017	F	

FDB2290

97.6 x 48.6 x 7.5 mm / 84.6 x 38.4 x 7.5 mm

MATERIAL AVAILABILITY											
AG	EF	P	PRP	ST	SM	SG	ZR	XRAC	ZRAC	CP1	CPRO
	✓										

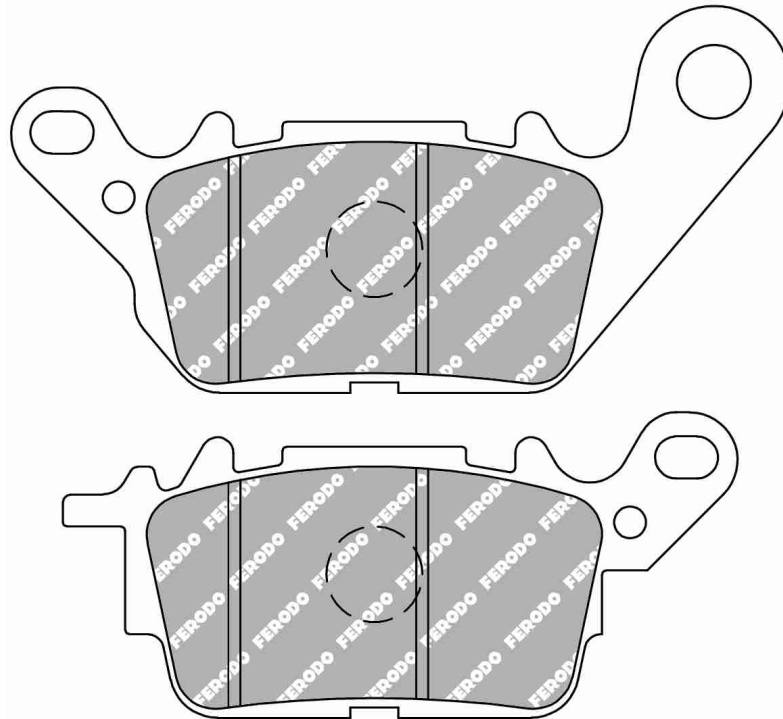

CROSS REFERENCE	
EBC	FA694
GALFER	FD503
NEWFREN	FD0535
VESRAH	VD-291

		CC	KW	FROM	TO	FRONT / REAR	LEFT / RIGHT
 YAMAHA	S 125 D'elight	125		2018		F	
	S NMAX (GPD125A)	125		2015		F	

		CC	KW	FROM	TO	FRONT / REAR	LEFT / RIGHT
 S NMAX		155	11	2019		F	

M = MOTORCYCLE
 S = SCOOTER
 A = ATV
 Sn = SNOWMOBILE

FDB2291

72.8 x 53.4 x 8.1 mm

MATERIAL AVAILABILITY

AG	EF	P	PRP	ST	SM	SG	ZR	XRAC	ZRAC	CP1	CPRO
	✓										

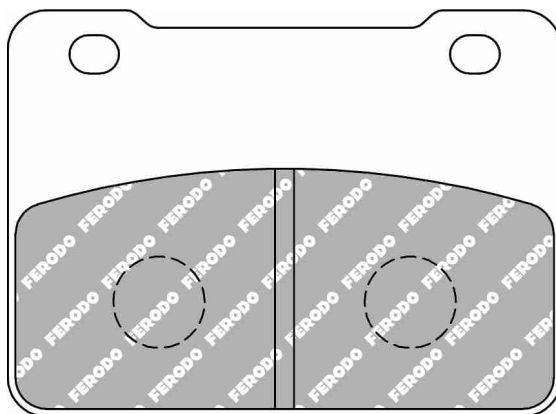
**CROSS REFERENCE**

BREMBO	07101
BREMBO	7101
EBC	SFA627
GALFER	FD481
GOLD FREN	331
LUCAS/TRW	MCB849
NEWFREN	FD0489
SBS	215
SBS	893



		CC	KW	FROM	TO	FRONT REAR	LEFT RIGHT
AEON	M Elite 400i (ABS)	400		2014		F	
SYM	M SB250 Ni - Wolf	250		2012		F	
	S Cruisym 300 i	300		2017		F	
	S Wolf 300 i Cafe' Racer	300		2015		F	



		CC	KW	FROM	TO	FRONT REAR	LEFT RIGHT
M	WOLF 300 Classic	300		2015		F	
S	Max Sym 400i	400		2011		F	
S	Max Sym 600i (ABS)	600		2014		F	

4336

FERODO

RACING

Updated on November 2020

M = MOTORCYCLE
 S = SCOOTER
 A = ATV
 Sn = SNOWMOBILE

FDB2292

83.2 x 48 x 12 mm

MATERIAL AVAILABILITY

AG	EF	P	PRP	ST	SM	SG	ZR	XRAC	ZRAC	CP1	CPRO
	✓										

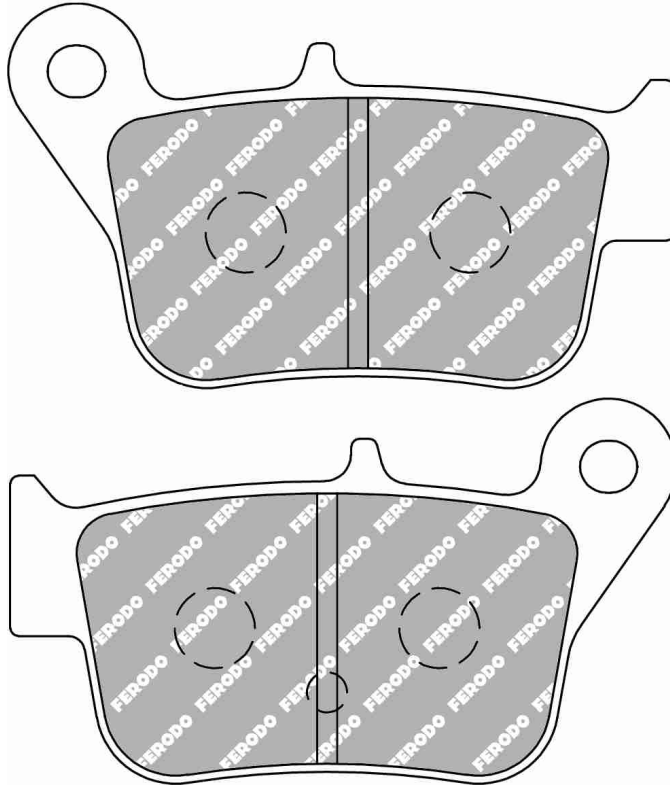



ALSO AVAILABLE

SHAPE	TH. MM	NOTES
FDB2312	9.2	

CROSS REFERENCE

BREMBO	7103
EBC	SFA628
GALFER	FD483
LUCAS/TRW	MCB873
NEWFREN	FD0490
SBS	218
SBS	218MS

		CC	KW	FROM	TO	FRONT / REAR	LEFT / RIGHT			CC	KW	FROM	TO	FRONT / REAR	LEFT / RIGHT
	SYM							S	Max Sym 400i	400		2011		R	
								S	Max Sym 600i (ABS)	600		2014		R	

M = MOTORCYCLE
S = SCOOTER
A = ATV
Sn = SNOWMOBILE

FDB2294

82.9 x 39.7 x 8 mm

MATERIAL AVAILABILITY											
AG	EF	P	PRP	ST	SM	SG	ZR	XRAC	ZRAC	CP1	CPRO
				✓							

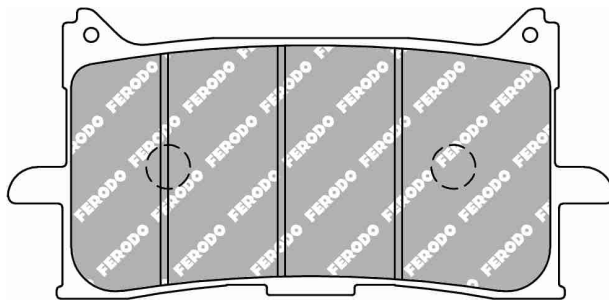

CROSS REFERENCE	
EBC	FA679
SBS	940
VESRAH	VD-187

		CC	KW	FROM	TO	FRONT REAR	LEFT RIGHT
	HONDA						
	M CB 125 R	125	10	2018		F	
	M CB 300 R	300	23	2018		F	
	M CB 650 R	650	70	2019		F	

		CC	KW	FROM	TO	FRONT REAR	LEFT RIGHT
	S	X-ADV	745		2017		F
	M	CRF 1000 L AFRICA TWIN	998	70	2016		F
	M	CRF 1000 L AFRICA TWIN Adventure Sport-DCT	998	70	2018		F

FDB2296

85.1 x 44.9 x 9 mm / 74.5 x 41.3 x 9 mm

MATERIAL AVAILABILITY

AG	EF	P	PRP	ST	SM	SG	ZR	XRAC	ZRAC	CP1	CPRO
	✓										

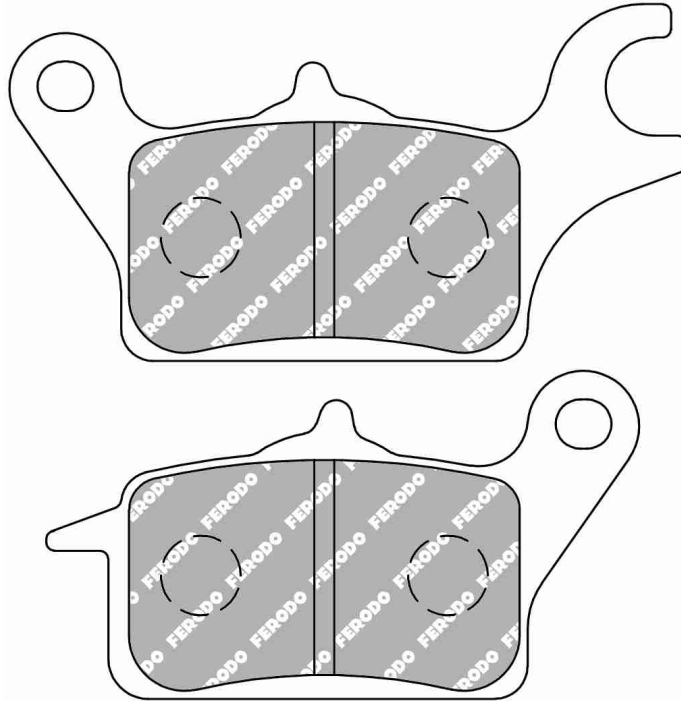



ALSO AVAILABLE

SHAPE	TH. MM	NOTES
FDB2282	7.3	

CROSS REFERENCE

EBC	SFA655
NEWFREN	FD0517
SBS	222
VESRAH	VD-186/2

		CC	KW	FROM	TO	FRONT / REAR	LEFT / RIGHT
 YAMAHA	S Tricity 125	125	8	2014		F	left
	S Tricity 155 ABS	155		2018		F	left

		CC	KW	FROM	TO	FRONT / REAR	LEFT / RIGHT
 S Tricity 300		300		2020		F	left

FDB2297

85.1 x 44.9 x 9 mm / 74.5 x 41.3 x 9 mm

MATERIAL AVAILABILITY											
AG	EF	P	PRP	ST	SM	SG	ZR	XRAC	ZRAC	CP1	CPRO
	✓										

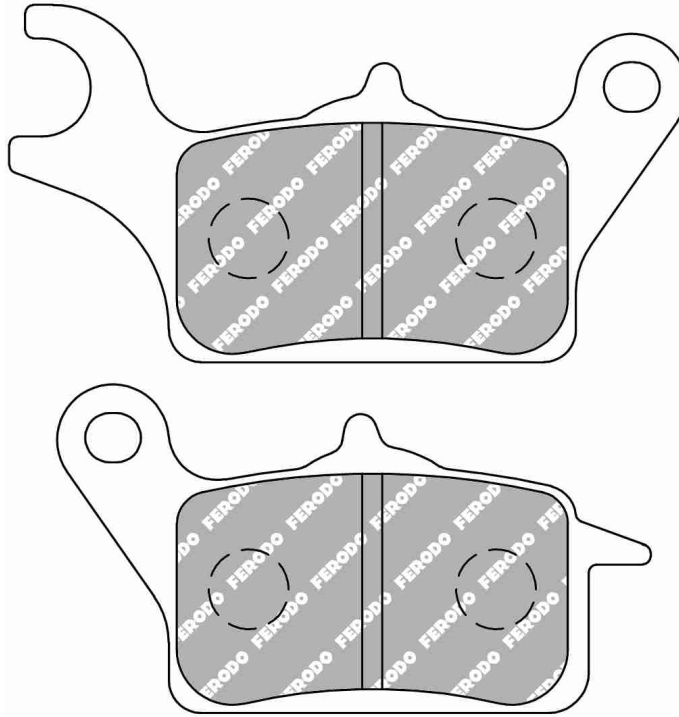

ALSO AVAILABLE		
SHAPE	TH. MM	NOTES
FDB2289	7.3	

CROSS REFERENCE	
EBC	SFA652
NEWFREN	FD0518
SBS	223

		CC	KW	FROM	TO	FRONT / REAR	LEFT / RIGHT
 YAMAHA	S	Tricity 125	125	8	2014	F	right
	S	Tricity 155 ABS	155		2018	F	right

		CC	KW	FROM	TO	FRONT / REAR	LEFT / RIGHT
 S	Tricity 300	300		2020		F	right

FDB2298

155.1 x 53.1 x 6.9 mm

MATERIAL AVAILABILITY											
AG	EF	P	PRP	ST	SM	SG	ZR	XRAC	ZRAC	CP1	CPRO
						✓					

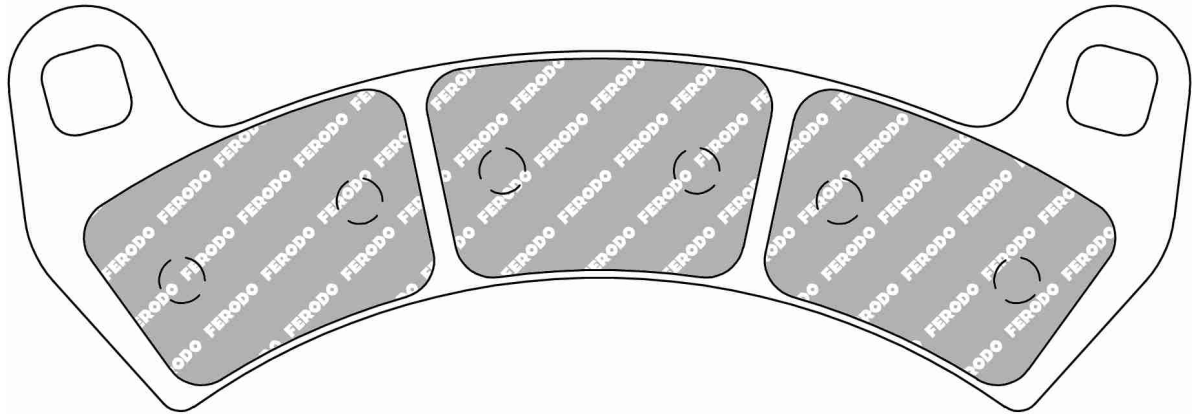

CROSS REFERENCE	
EBC	FA680

		CC	KW	FROM	TO	FRONT / REAR	LEFT / RIGHT
	POLARIS ATV A RZR XP Turbo	1000		2016		F	

		CC	KW	FROM	TO	FRONT / REAR	LEFT / RIGHT
	A RZR XP 4 Turbo	1000		2016		F	

M = MOTORCYCLE
S = SCOOTER
A = ATV
Sn = SNOWMOBILE

FDB2299

118 x 48.6 x 9.4 mm / 118 x 48.6 x 9.4 mm

Refit OE shim/insulator - P compound available on Sept. 2018

MATERIAL AVAILABILITY											
AG	EF	P	PRP	ST	SM	SG	ZR	XRAC	ZRAC	CP1	CPR0
		✓		✓							

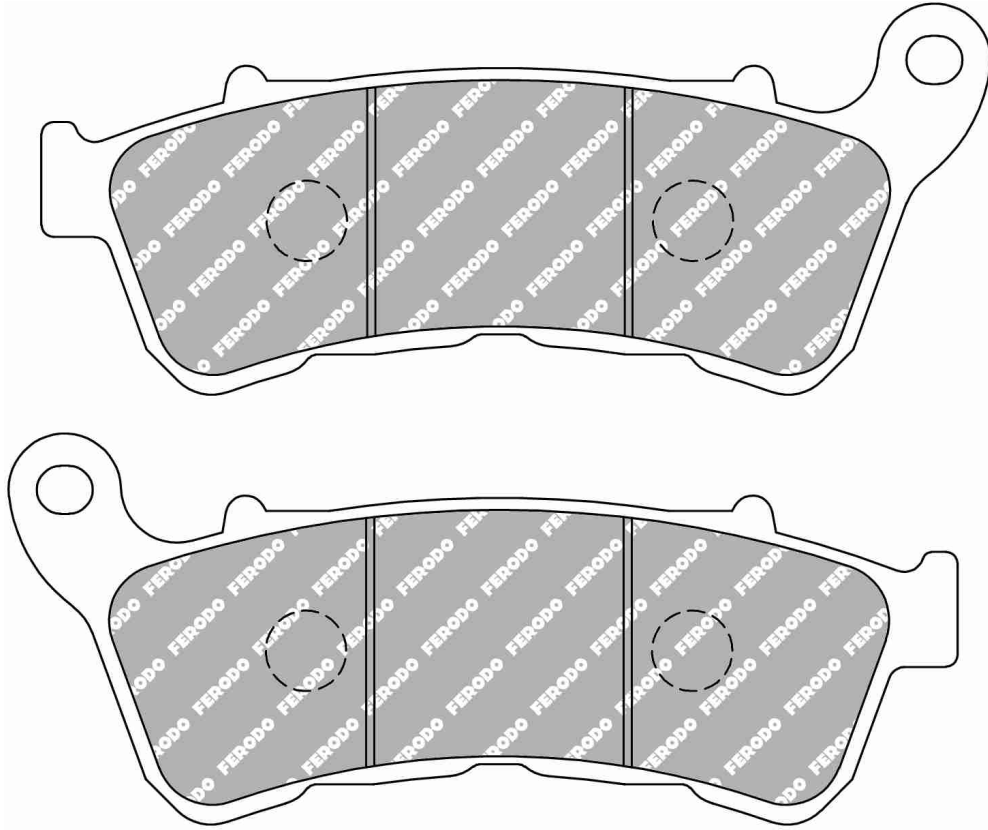

CROSS REFERENCE	
EBC	FA640

		CC	KW	FROM	TO	FRONT / REAR	LEFT / RIGHT
	HARLEY DAVIDSON M XL 883 L (Cast Wheels)	883		2014	2017	F	
	M XL 883 N	883		2016		F	
	M XL 883 N Iron (Cast Wheel)	883		2014	2017	F	
	M XL 883 R Roadster (Cast Wheel)	883		2014		F	
	M XL 1200 X - Forty Eight	1200	50	2014	2017	F	
	M XL 1200 C Custom (Spoke Wheels)	1200		2014	2017	F	

		CC	KW	FROM	TO	FRONT / REAR	LEFT / RIGHT
	M XL 1200 T Superlow	1200		2014		F	
	M XL 1200 V - Seventy Two	1200		2014		F	
	M XL 1200 NS Iron	1202		2019		F	
	M XL 1200 XS Forty Eight Special	1202		2019		F	
	M XL 1200 CX Roadster	1202		2016	2017	F	

FDB2300

78 x 42.6 x 7.9 mm

MATERIAL AVAILABILITY											
AG	EF	P	PRP	ST	SM	SG	ZR	XRAC	ZRAC	CP1	CPRO
				✓				✓			

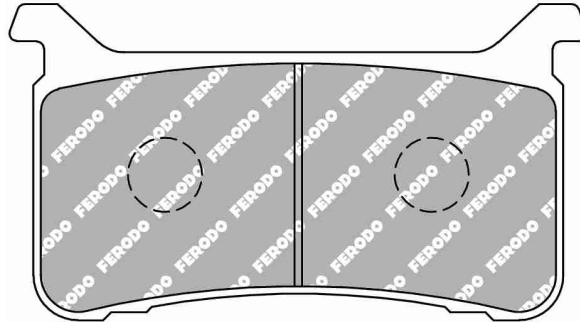

CROSS REFERENCE	
GALFER	FD519

		CC	KW	FROM	TO	FRONT / REAR	LEFT / RIGHT
 HONDA	M	VFR 800 F	800		2018	F	
	M	CB 1000 R plus	998	107	2018	F	
	M	CB 1000 R	1000	107	2018	F	

		CC	KW	FROM	TO	FRONT / REAR	LEFT / RIGHT
 HONDA	M	CBR 1000 RR	1000		2017	F	
	M	CB 1100 RS	1100	66	2017	F	

M = MOTORCYCLE
 S = SCOOTER
 A = ATV
 Sn = SNOWMOBILE

FDB2301

104.1 x 46 x 8.25 mm / 88.1 x 46 x 8.25 mm

MATERIAL AVAILABILITY											
AG	EF	P	PRP	ST	SM	SG	ZR	XRAC	ZRAC	CP1	CPRO
						✓					

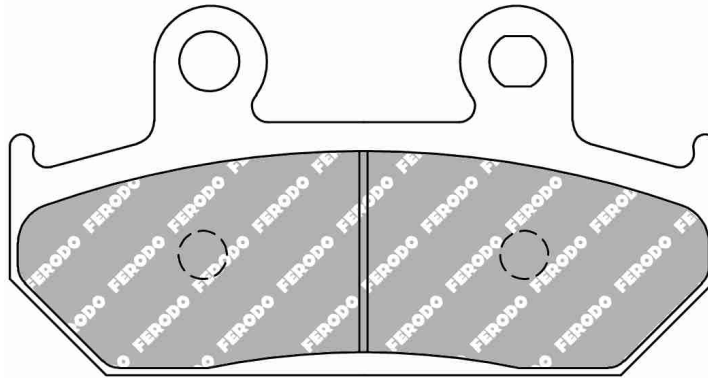
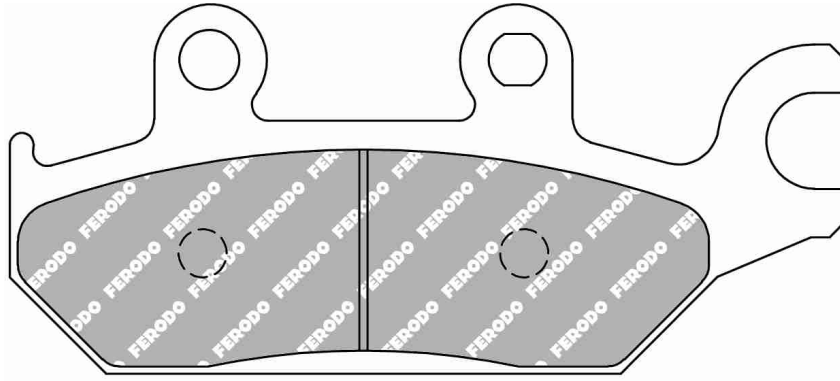

ALSO AVAILABLE		
SHAPE	TH. MM	NOTES
FDB2302		Coupled sets

CROSS REFERENCE	
EBC	FA642

		CC	KW	FROM	TO	FRONT / REAR	LEFT / RIGHT
	CAN AM ATV	A	Commander Max 1000 DPS/XT	1000	2014	F	left
		A	Maverick Max 1000 STD/XRS/DPS	1000	2014	2015	F
YAMAHA ATV	A	YXC 700 E Viking VI EPS	700	2015	2016	F	left

		CC	KW	FROM	TO	FRONT / REAR	LEFT / RIGHT
	A	YXM 700 ES Viking EPS SE	700	2014	2016	F	left
	A	YXM 700 E Viking EPS COMO	700	2016		F	left
	A	YXM 700 E Wolverine R	700	2016		F	left

FDB2302

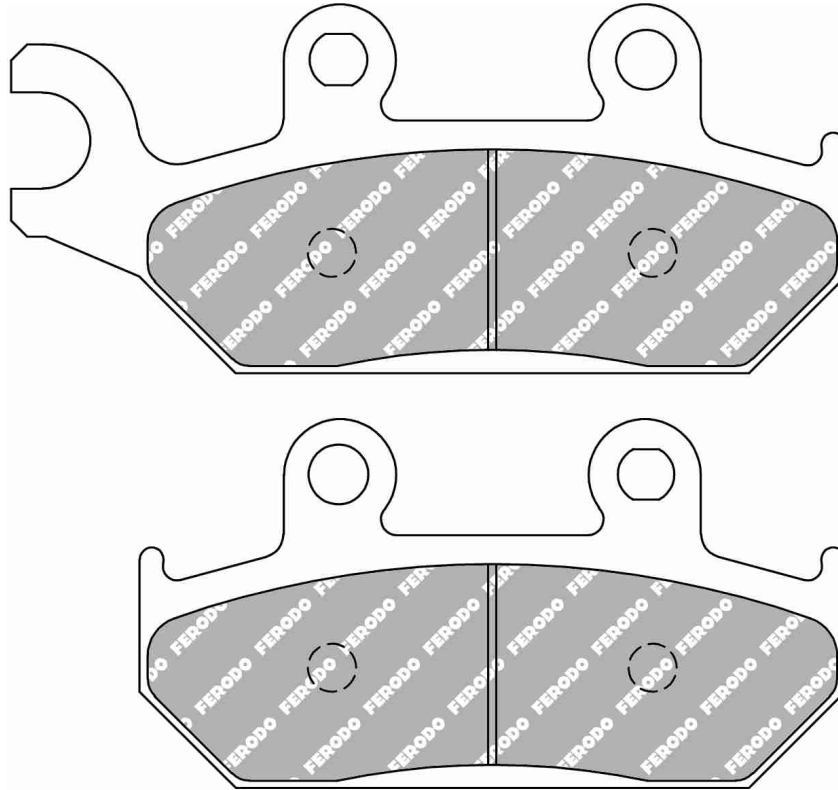

104.1 x 46 x 8.25 mm / 88.1 x 46 x 8.25 mm

MATERIAL AVAILABILITY											
AG	EF	P	PRP	ST	SM	SG	ZR	XRAC	ZRAC	CP1	CPRO
						✓					



ALSO AVAILABLE		
SHAPE	TH. MM	NOTES
FDB737	10	
FDB2301		Coupled sets

CROSS REFERENCE	
EBC	FA645

		CC	KW	FROM	TO	FRONT / REAR	LEFT / RIGHT		
	CAN AM ATV	A	Commander Max 1000 DPS/XT	1000		2014	F	right	
		A	Maverick Max 1000 STD/XRS/DPS	1000		2014	2015	F	right
	YAMAHA ATV	A	YXC 700 E Viking VI EPS	700		2015	2016	F	right

		CC	KW	FROM	TO	FRONT / REAR	LEFT / RIGHT		
		A	YXM 700 ES Viking EPS SE	700		2014	2016	F	right
		A	YXM 700 E Viking EPS COMO	700		2016		F	right
		A	YXM 700 E Wolverine R	700		2016		F	right

M = MOTORCYCLE
S = SCOOTER
A = ATV
Sn = SNOWMOBILE

FDB2303

94.6 x 45.5 x 7.1 mm

MATERIAL AVAILABILITY

AG	EF	P	PRP	ST	SM	SG	ZR	XRAC	ZRAC	CP1	CPRO
						✓					

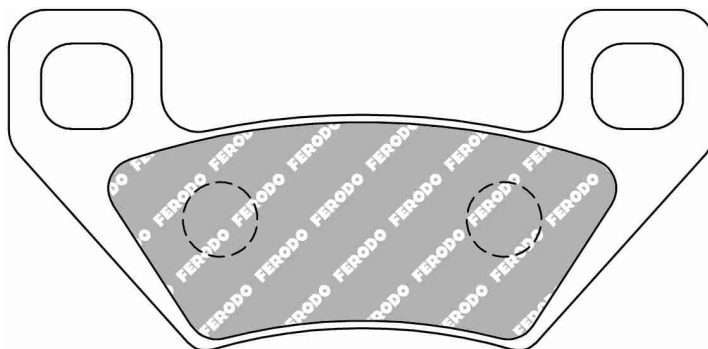

CROSS REFERENCE

EBC	FA395
-----	-------

		CC	KW	FROM	TO	FRONT REAR	LEFT RIGHT
	ARCTIC CAT	A 250 2 X 4 Utility	250	2005	2009	F	
		A 250 2 X 4 Utility	250	2005	2009	R	
		A 250 4 X 4 Utility	250	2008		F	
		A 250 4 X 4 Utility	250	2008		R	
		A 300 4 X 4 Utility	300	2005		F	
		A 300 4 X 4 Utility	300	2005		R	
		A 300 ATV	300	2010	2012	F	
		A 300 ATV	300	2010	2012	R	
		A 350 ATV	350	2012		F	
		A 350 ATV	350	2012		R	
		A 366 4 X 4 Auto Utility	366	2008	2009	F	
		A 366 4 X 4 Auto Utility	366	2008	2009	R	
		A 366 SE	366	2010		F	
		A 366 SE	366	2010		R	
		A 400 4 X 4 Utility	400	2005	2007	F	
		A 400 4 X 4 Utility	400	2005	2007	R	
		A 400 4 X 4 VP Utility	400	2005	2006	F	
		A 400 4 X 4 VP Utility	400	2005	2006	R	
		A 400 4 X 4 Auto LE Utility	400	2005	2007	F	
		A 400 4 X 4 Auto LE Utility	400	2005	2007	R	
		A 400 4 X 4 Auto TBX Utility	400	2005	2006	F	
		A 400 4 X 4 Auto TBX Utility	400	2005	2006	R	
		A 400 4 X 4 Auto Utility	400	2005	2008	F	
		A 400 4 X 4 Auto Utility	400	2005	2008	R	
		A 400 4 X 4 Auto VP Utility	400	2005	2006	F	
		A 400 4 X 4 Auto VP Utility	400	2005	2006	R	
		A 400 4X Auto TRV Multirider	400	2006		F	
		A 400 4X Auto TRV Multirider	400	2006		R	
		A 400 4X Auto TRV Plus Multirider	400	2007		F	
		A 400 4X Auto TRV Plus Multirider	400	2007		R	
		A 400 TRV	400	2009		F	
		A 400 TRV	400	2009		R	
		A 400 TRV H1	400	2010		F	
		A 400 TRV H1	400	2010		R	
		A 425i	425	2012		F	
		A 425i	425	2012		R	
		A 425i SE	425	2012		F	
		A 425i SE	425	2012		R	
		A 450 H1 EFi	450	2010		F	
		A 450 H1 EFi	450	2010		R	
		A 450 TRV	450	2011	2012	F	
		A 450 TRV	450	2011	2012	R	
		A 450i	450	2011	2012	F	
		A 450i	450	2011	2012	R	
		A 450i TRV	450	2011		F	
		A 450i TRV	450	2011		R	
		A XC450i	450	2011	2012	F	
		A XC450i	450	2011	2012	R	
		A 450i GT	450	2012		F	
		A 450i GT	450	2012		R	
		A 500 4 x 4 Auto LE Utility	500	2005	2006	F	
		A 500 4 x 4 Auto LE Utility	500	2005	2006	R	
		A 500 4 x 4 Auto TBX Utility	500	2005	2006	F	
		A 500 4 x 4 Auto TBX Utility	500	2005	2006	R	

		CC	KW	FROM	TO	FRONT REAR	LEFT RIGHT
		A 500 4 x 4 Auto TRV Multirider	500	2005	2008	F	
		A 500 4 x 4 Auto TRV Multirider	500	2005	2008	R	
		A 500 4 x 4 Auto Utility	500	2005	2008	F	
		A 500 4 x 4 Auto Utility	500	2005	2008	R	
		A 500 4 x 4 Manual G/Box Utility	500	2005	2009	F	
		A 500 4 x 4 Manual G/Box Utility	500	2005	2009	R	
		A 550 HI EFi	550	2009	2010	F	
		A 550 HI EFi	550	2009	2010	R	
		A 550 HI EFi LE	550	2009	2010	F	
		A 550 HI EFi LE	550	2009	2010	R	
		A 550 HI EFi Prowler	550	2009		F	
		A 550 HI EFi Prowler	550	2009		R	
		A 550 TRV EFi	550	2009	2010	F	
		A 550 TRV EFi	550	2009	2010	R	
		A 550 TRV EFi LE	550	2009	2010	F	
		A 550 TRV EFi LE	550	2009	2010	R	
		A 550 GT S TRV	550	2010		F	
		A 550 GT S TRV	550	2010		R	
		A 550 S	550	2010		F	
		A 550 S	550	2010		R	
		A 550 S LTD	550	2010		F	
		A 550 S LTD	550	2010		R	
		A XT 550	550	2010	2011	F	
		A XT 550	550	2010	2011	R	
		A 550 GT TRV	550	2011	2012	F	
		A 550 GT TRV	550	2011	2012	R	
		A 550 TRV	550	2011		F	
		A 550 TRV	550	2011		R	
		A 550 TRV Cruiser	550	2011		F	
		A 550 TRV Cruiser	550	2011		R	
		A 550i	550	2011	2012	F	
		A 550i	550	2011	2012	R	
		A 550i GT	550	2011	2012	F	
		A 550i GT	550	2011	2012	R	
		A 550i GT TRV	550	2011		F	
		A 550i GT TRV	550	2011		R	
		A 550i LTD	550	2011	2012	F	
		A 550i LTD	550	2011	2012	R	
		A 550i TRV Cruiser	550	2011		F	
		A 550i TRV Cruiser	550	2011		R	
		A XT 550 i Prowler	550	2011	2012	F	
		A XT 550 i Prowler	550	2011	2012	R	
		A 650 V2 4 X 4 Auto LE Utility	650	2004	2005	F	
		A 650 V2 4 X 4 Auto LE Utility	650	2004	2005	R	
		A 650 V2 4 X 4 Auto Utility	650	2004	2006	F	
		A 650 V2 4 X 4 Auto Utility	650	2004	2006	R	
		A 650 V2 4 X 4 Auto LE TS Utility	650	2006		F	
		A 650 V2 4 X 4 Auto LE TS Utility	650	2006		R	
		A XT 650 H1 Prowler	650	2006	2009	F	
		A XT 650 H1 Prowler	650	2006	2009	R	
		A 650 H1 Prowler	650	2007		F	
		A 650 H1 Prowler	650	2007		R	
		A 650 HI TBX 4x4 Auto Utility	650	2007		F	
		A 650 HI TBX 4x4 Auto Utility	650	2007		R	

4346



		CC	KW	FROM	TO	FRONT / REAR	LEFT / RIGHT
A	650 HI TRV 4X4 Auto Plus LE Multirider	650		2007		F	
A	650 HI TRV 4X4 Auto Plus LE Multirider	650		2007		R	
A	650 HI TRV 4X4 Auto Plus Multirider	650		2007		F	
A	650 HI TRV 4X4 Auto Plus Multirider	650		2007		R	
A	650 Prowler 4 X 4 / M4	650		2008		F	
A	650 Prowler 4 X 4 / M4	650		2008		R	
A	650 HI TRV 4X4 Auto	650		2008		F	
A	650 HI TRV 4X4 Auto	650		2008		R	
A	650 H1 TRV	650		2009		F	
A	650 H1 TRV	650		2009		R	
A	650 TBX	650		2009		F	
A	650 TBX	650		2009		R	
A	650 H1	650		2010		F	
A	650 H1	650		2010		R	
A	650 H1 Mudpro	650		2010		F	
A	650 H1 Mudpro	650		2010		R	
A	650 Mudpro	650		2010	2011	F	
A	650 Mudpro	650		2010	2011	R	
A	700 EFi 4 X 4 LE Utility	700		2006		F	
A	700 EFi 4 X 4 LE Utility	700		2006		R	
A	700 EFi 4 X 4 SE Utility	700		2006		F	
A	700 EFi 4 X 4 SE Utility	700		2006		R	
A	700 Diesel Utility	700		2007	2008	F	
A	700 Diesel Utility	700		2007	2008	R	
A	700 EFi 4 X 4 Utility	700		2007	2008	F	
A	700 EFi 4 X 4 Utility	700		2007	2008	R	
A	700 EFi 4 x 4 Auto M4	700		2008		F	
A	700 EFi 4 x 4 Auto M4	700		2008		R	
A	700 EFi 4 x 4 Auto TRV LE	700		2008		F	
A	700 EFi 4 x 4 Auto TRV LE	700		2008		R	
A	700 HI EFi 4x4 Auto SE	700		2008	2009	F	
A	700 HI EFi 4x4 Auto SE	700		2008	2009	R	
A	XTX 700 Hi LE Prowler	700		2008		F	
A	XTX 700 Hi LE Prowler	700		2008		R	
A	700 H1 EFi	700		2009	2010	F	
A	700 H1 EFi	700		2009	2010	R	
A	700 H1 EFi Mudpro	700		2009	2010	F	
A	700 H1 EFi Mudpro	700		2009	2010	R	
A	700 H1 EFi LE	700		2009	2010	F	
A	700 H1 EFi LE	700		2009	2010	R	
A	700 TRV H2 EFi Cruiser	700		2009	2010	F	
A	700 TRV H2 EFi Cruiser	700		2009	2010	R	
A	XTX 700 Hi EFi Prowler	700		2009		F	
A	XTX 700 Hi EFi Prowler	700		2009		R	
A	700 H1 TBX EFi	700		2010		F	
A	700 H1 TBX EFi	700		2010		R	
A	700 Mudpro	700		2010	2011	F	
A	700 Mudpro	700		2010	2011	R	
A	700 S	700		2010		F	
A	700 S	700		2010		R	
A	700 S LTD	700		2010		F	
A	700 S LTD	700		2010		R	
A	700 Super Duty Diesel	700		2010	2011	F	
A	700 Super Duty Diesel	700		2010	2011	R	
A	XTX 700	700		2010	2011	F	
A	XTX 700	700		2010	2011	R	
A	700 EFi Cruiser	700		2011		F	
A	700 EFi Cruiser	700		2011		R	
A	700 TBX LTD	700		2011		F	
A	700 TBX LTD	700		2011		R	
A	700 TRV	700		2011	2012	F	
A	700 TRV	700		2011	2012	R	
A	700 TRV Cruiser	700		2011	2012	F	
A	700 TRV Cruiser	700		2011	2012	R	
A	700 TRV GT	700		2011	2012	F	
A	700 TRV GT	700		2011	2012	R	



		CC	KW	FROM	TO	FRONT / REAR	LEFT / RIGHT
A	700i	700		2011	2012	F	
A	700i	700		2011	2012	R	
A	700i GT	700		2011	2012	F	
A	700i GT	700		2011	2012	R	
A	700i LTD	700		2011	2012	F	
A	700i LTD	700		2011	2012	R	
A	700i Mudpro	700		2011	2012	F	
A	700i Mudpro	700		2011	2012	R	
A	700i Mudpro LTD	700		2011		F	
A	700i Mudpro LTD	700		2011		R	
A	HDX 700 i Prowler	700		2011		F	
A	HDX 700 i Prowler	700		2011		R	
A	HDX 700 Prowler	700		2011		F	
A	HDX 700 Prowler	700		2011		R	
A	XTX 700 i Prowler	700		2011	2012	F	
A	XTX 700 i Prowler	700		2011	2012	R	
A	Thundercat 1000 H2	1000		2008	2010	F	
A	Thundercat 1000 H2	1000		2008	2010	R	
A	1000 TRV H2 EFi Cruiser	1000		2009	2010	F	
A	1000 TRV H2 EFi Cruiser	1000		2009	2010	R	
A	XTZ 1000 H2 Prowler	1000		2009		F	
A	XTZ 1000 H2 Prowler	1000		2009		R	
A	1000 H2 Mudpro EFi	1000		2010		F	
A	1000 H2 Mudpro EFi	1000		2010		R	
A	1000 Mudpro	1000		2010	2011	F	
A	1000 Mudpro	1000		2010	2011	R	
A	1000 TRV H2 Efi	1000		2010		F	
A	1000 TRV H2 Efi	1000		2010		R	
A	Thundercat 1000 H2 LE	1000		2010		F	
A	Thundercat 1000 H2 LE	1000		2010		R	
A	XTZ 1000	1000		2010	2011	F	
A	XTZ 1000	1000		2010	2011	R	
A	1000 GT	1000		2011	2012	F	
A	1000 GT	1000		2011	2012	R	
A	1000 TRV Cruiser	1000		2011		F	
A	1000 TRV Cruiser	1000		2011		R	
A	XTZ 1000 i	1000		2011	2012	F	
A	XTZ 1000 i	1000		2011	2012	R	
A	1000i Mudpro	1000		2012		F	
A	1000i Mudpro	1000		2012		R	
A	WILDCAT 1000i H.O.	1000		2012		F	
A	WILDCAT 1000i H.O.	1000		2012		R	
KYMCO ATV	A Maxxer 400	400		2009	2010	F	
	A Maxxer 400	400		2009	2010	R	
	A MXU 400 (A40000)	400		2008	2011	F	
	A MXU 400 (A40000)	400		2008	2011	R	
	A Maxxer 450 i	450		2010	2012	F	
	A Maxxer 450 i	450		2010	2012	R	
	A MXU 450 i IRS	450		2011	2012	F	
	A MXU 450 i IRS	450		2011	2012	R	
MASSEY-FERGUSON	A MF 400/4WD Auto (376cc)	400		2005	2009	F	
	A MF 400/4WD Auto (376cc)	400		2005	2009	R	
	A MF 500/4WD Auto (493cc)	500		2005	2009	F	
	A MF 500/4WD Auto (493cc)	500		2005	2009	R	
	A MF 650 2 cyl/4WD Auto (633cc)	650		2005	2009	F	
	A MF 650 2 cyl/4WD Auto (633cc)	650		2005	2009	R	
	A MF 650/4WD Auto (641cc)	650		2005	2009	F	
	A MF 650/4WD Auto (641cc)	650		2005	2009	R	
	A MF 700 2 D/4WD Auto (686cc Diesel)	700		2005	2008	F	
	A MF 700 2 D/4WD Auto (686cc Diesel)	700		2005	2008	R	
PIAGGIO	A Trackmaster 400 Quad	400		2006		F	
	A Trackmaster 400 Quad	400		2006		R	
POLARIS ATV	A 300 Hawkeye 2x4	300		2006		F	
	A 300 Hawkeye 2x4	300		2006		R	
	A 300 Hawkeye 4x4	300		2006		F	
	A 300 Hawkeye 4x4	300		2006		R	

M = MOTORCYCLE
S = SCOOTER
A = ATV
Sn = SNOWMOBILE

FDB2304

85.6 x 37.9 x 8.8 mm

In introduction

MATERIAL AVAILABILITY											
AG	EF	P	PRP	ST	SM	SG	ZR	XRAC	ZRAC	CP1	CPRO
	✓										

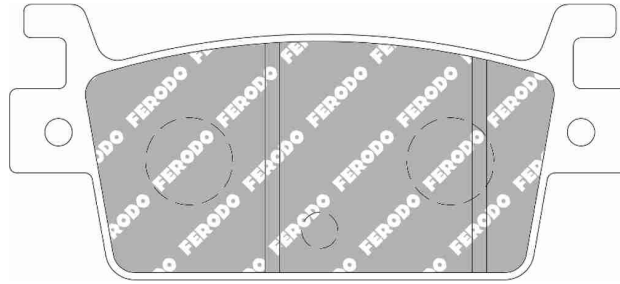

CROSS REFERENCE	
EBC	SFA719
GALFER	FD526



KYMCO	S	AK 550	CC	KW	FROM	TO	FRONT		LEFT	
							REAR	RIGHT		
			550	39	2017		R			

FDB2305

98.6 x 42.2 x 9 mm / 76.5 x 42.2 x 9 mm

MATERIAL AVAILABILITY											
AG	EF	P	PRP	ST	SM	SG	ZR	XRAC	ZRAC	CP1	CPRO
	✓										

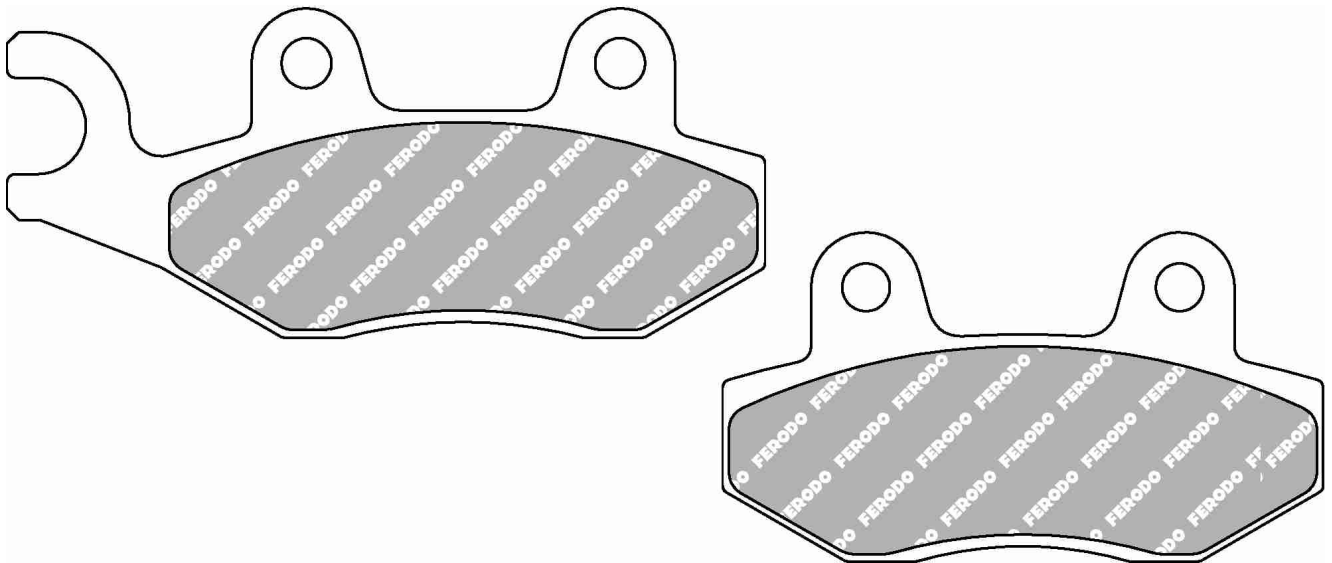

ALSO AVAILABLE		
SHAPE	TH. MM	NOTES
FDB497	7.6	

CROSS REFERENCE	
EBC	FA228
SBS	163

		CC	KW	FROM	TO	FRONT REAR	LEFT RIGHT
	AEON						
	S Urban 125	125		2011	2013	F	
	S Elite 125	125		2013		F	
	S Elite 250	250		2011		F	
	S Urban 350	350		2011		F	
	BENELLI						
	S Zenzero 350	350		2012		F	
	GENERIC						
	S Zion 125	125		2008		F	
	KYMCO						
	S AGILITY 50 (KG10SA)	50		2005	2008	F	
	S AGILITY 50 R10 (4T)	50		2006		F	
	S AGILITY 50 R12 (4T)	50		2006		F	
	S AGILITY RS Naked 50 2T	50		2010		F	
	S Agility RS Naked (4T)	50	2	2019		F	

		CC	KW	FROM	TO	FRONT REAR	LEFT RIGHT	
	S	AGILITY 125	125		2006	2008	F	
	S	AGILITY 125 R12 (4T)	125		2006		F	
	S	AGILITY RS 125 R12 (4T)	125		2010		F	
	S	AGILITY RS 125 R12 (4T) Naked +	125		2010		F	
	S	LIKE II 125 i ABS Exclusive	125	6	2017		F	
	M	STRYKER 150 (Off-Road)	150		2000	2006	F	
	S	Vivio 150	150		2000	2003	F	
	MALAGUTI	M	BLOG 125	125		2008		F
	M	CENTRO 125 ie/SL	125		2007	2011	F	
	M	BLOG 160	160		2008		F	
M	CENTRO 160 ie	160		2008	2011	F		

FDB2306

82.1 x 42 x 10 mm

MATERIAL AVAILABILITY

AG	EF	P	PRP	ST	SM	SG	ZR	XRAC	ZRAC	CP1	CPO
		✓		✓							

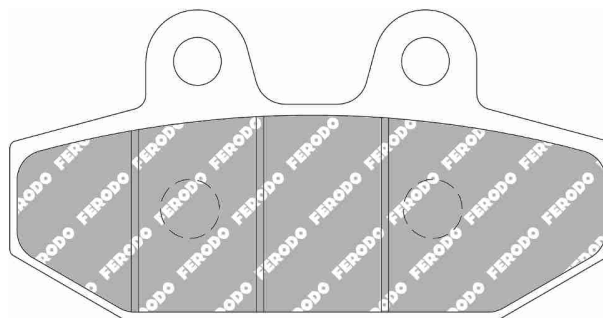

CROSS REFERENCE

BREMBO	07HD23
EBC	FA710
SBS	949

		CC	KW	FROM	TO	FRONT REAR	LEFT RIGHT
	HARLEY DAVIDSON						
	M FLDE Deluxe	1745		2018		R	
	M FLFB Fat Boy	1745		2018		R	
	M FLHC Heritage Classic	1745		2018		R	
	M FLSL Softail Slim	1745		2018		R	
	M FXBB Street Bob	1745		2018		R	
	M FXBR Breakout	1745		2018		R	
	M FXBS Fat Bob	1745		2018		R	
M FXFB Fat Bob	1745		2018		R		

		CC	KW	FROM	TO	FRONT REAR	LEFT RIGHT
	M	FXLR Low Rider	1745		2018		R
	M	FLSB Sport Glide	1745		2018		R
	M	FLFBS Fat Boy 114	1868		2018		R
	M	FLHCS Heritage Classic 114	1868		2018		R
	M	FXBRS Breakout 114	1868		2018		R
	M	FXDR 114	1868		2020		R
	M	FXDRS 114	1868		2019		R
	M	FXFBS Fat Bob	1868		2018		R

M = MOTORCYCLE
S = SCOOTER
A = ATV
Sn = SNOWMOBILE

FDB2307

82.2 x 40.9 x 8.3 mm / 62.1 x 40.9 x 8.3 mm

MATERIAL AVAILABILITY											
AG	EF	P	PRP	ST	SM	SG	ZR	XRAC	ZRAC	CP1	CPRO
						✓					

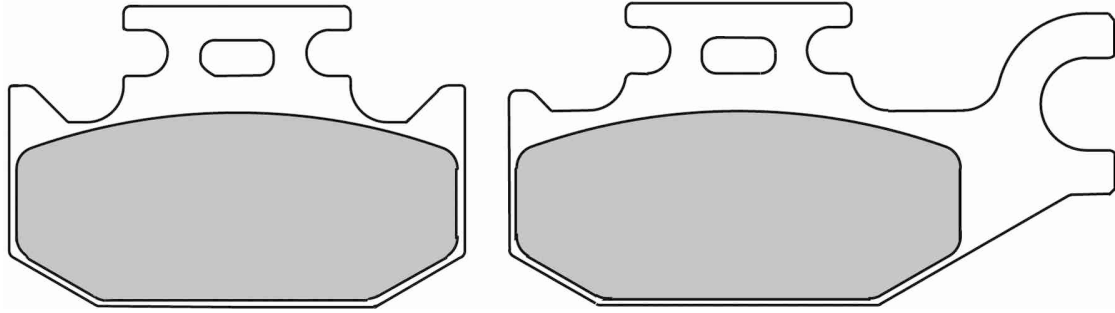

ALSO AVAILABLE		
SHAPE	TH. MM	NOTES
FDB2148	9.4	
FDB2308		Coupled set

CROSS REFERENCE	
SBS	835

		CC	KW	FROM	TO	FRONT REAR	LEFT RIGHT
SUZUKI ATV	A LT-A 400 F KING QUAD 4X4	400		2008	2011	F	left
	A LT-F 400 KING QUAD FS 4X4	400		2008	2012	F	left
	A LT-F 400 KING QUAD 4X2	400		2008	2010	F	left
	A LT-A 450 X KING QUAD 4X4	450		2007	2010	F	left
	A LT-A 500 KING QUAD XP	500		2009	2012	F	left

		CC	KW	FROM	TO	FRONT REAR	LEFT RIGHT
	A LT-A 500 KING QUAD X	500		2012	2012	F	left
	A LT-A 700 KING QUAD	700		2005	2007	F	left
	A TWIN PEAKS 700	700		2004	2005	F	left
	A LT-A 750 KING QUAD X	750		2008	2012	F	left
	A LT-A 750 KING QUAD XP	750		2009	2012	F	left

FDB2308

82.2 x 40.9 x 8.3 mm / 62.1 x 40.9 x 8.3 mm

MATERIAL AVAILABILITY											
AG	EF	P	PRP	ST	SM	SG	ZR	XRAC	ZRAC	CP1	CPRO
						✓					

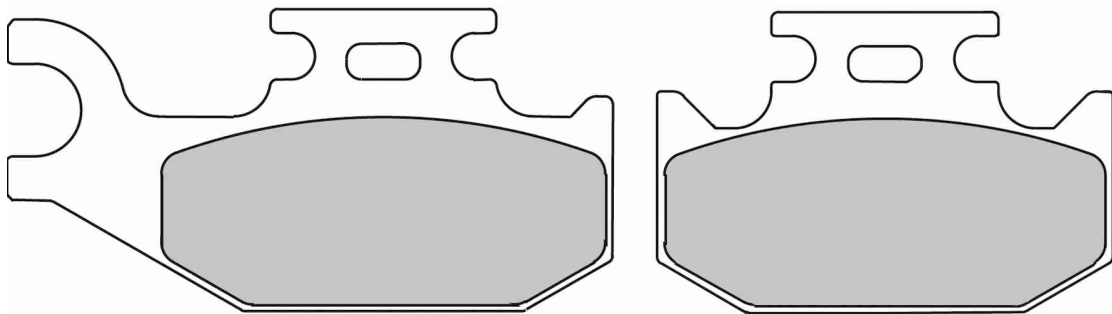

ALSO AVAILABLE		
SHAPE	TH. MM	NOTES
FDB2149	9.4	
FDB2307		Coupled set

CROSS REFERENCE	
SBS	836

		CC	KW	FROM	TO	FRONT / REAR	LEFT / RIGHT
SUZUKI ATV	A	LT-A 400 F KING QUAD 4X4	400	2008	2011	F	right
	A	LT-F 400 KING QUAD FS 4X4	400	2008	2012	F	right
	A	LT-F 400 KING QUAD 4X2	400	2008	2010	F	right
	A	LT-A 450 X KING QUAD 4X4	450	2007	2010	F	right
	A	LT-A 500 KING QUAD XP	500	2009	2012	F	right

		CC	KW	FROM	TO	FRONT / REAR	LEFT / RIGHT
	A	LT-A 500 KING QUAD X	500	2012	2012	F	right
	A	LT-A 700 KING QUAD	700	2005	2007	F	right
	A	TWIN PEAKS 700	700	2004	2005	F	right
	A	LT-A 750 KING QUAD X	750	2008	2012	F	right
	A	LT-A 750 KING QUAD XP	750	2009	2012	F	right

FDB2310

94.6 x 38.1 x 8.5 mm / 114.8 x 30.6 x 8.5 mm

MATERIAL AVAILABILITY											
AG	EF	P	PRP	ST	SM	SG	ZR	XRAC	ZRAC	CP1	CPR0
	✓										

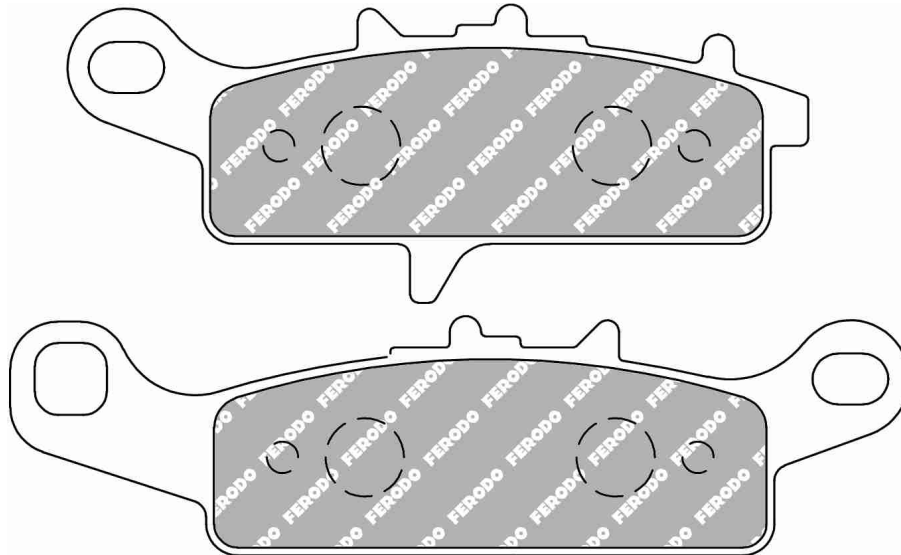

		CC	KW	FROM	TO	FRONT / REAR	LEFT / RIGHT
GOGORO	S	Gogoro II (Electric)	6	2018		F	

		CC	KW	FROM	TO	FRONT / REAR	LEFT / RIGHT
YAMAHA	S	RS Zero	100	2017		F	

FDB2311

83.7 x 41.1 x 9 mm / 99.3 x 42.1 x 8.2 mm

MATERIAL AVAILABILITY

AG	EF	P	PRP	ST	SM	SG	ZR	XRAC	ZRAC	CP1	CPRO
	✓										

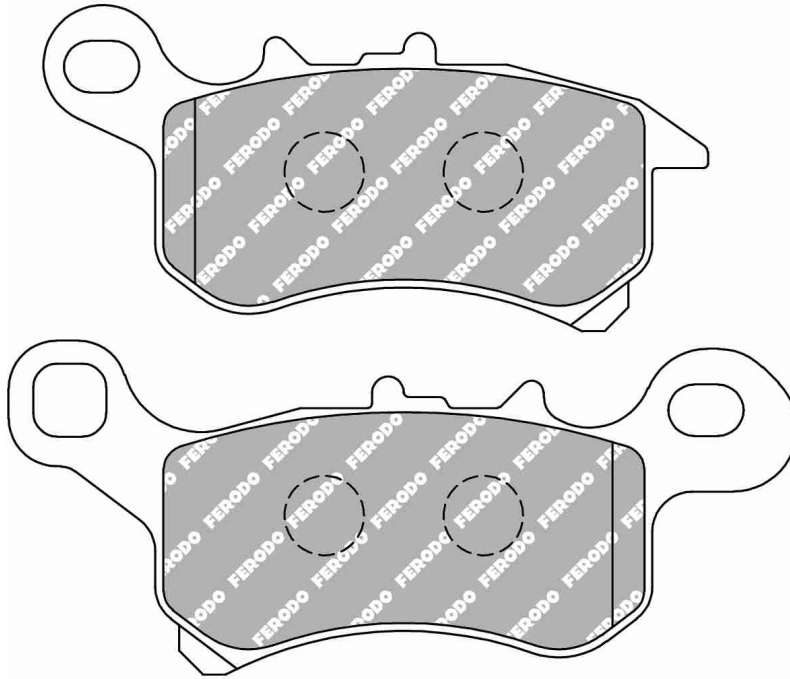

YAMAHA

S Cuxi

CC	KW	FROM	TO	FRONT	LEFT
				REAR	RIGHT
115		2017		F	

FDB2312

83.2 x 48 x 9.2 mm

MATERIAL AVAILABILITY

AG	EF	P	PRP	ST	SM	SG	ZR	XRAC	ZRAC	CP1	CPRO
	✓										

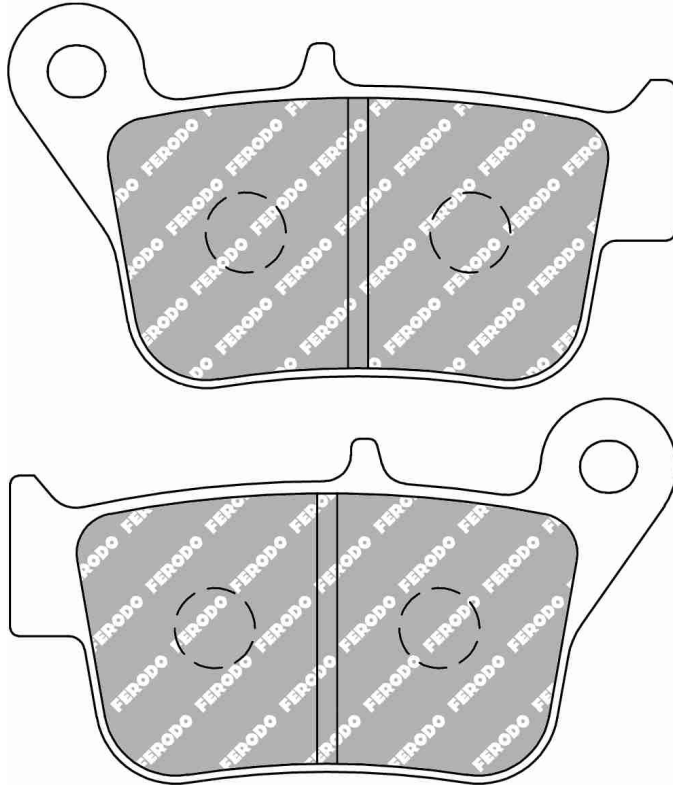

ALSO AVAILABLE

SHAPE	TH. MM	NOTES
FDB2292	12	Without pin



SYM	S	Fighter VI	CC	KW	FROM	TO	FRONT / REAR		LEFT / RIGHT	
			150		2010	2015	R			

M = MOTORCYCLE
S = SCOOTER
A = ATV
Sn = SNOWMOBILE

FDB2313

101.6 x 43.8 x 7.6 mm / 98.6 x 43.8 x 7.6 mm

MATERIAL AVAILABILITY											
AG	EF	P	PRP	ST	SM	SG	ZR	XRAC	ZRAC	CP1	CPRO
	✓										

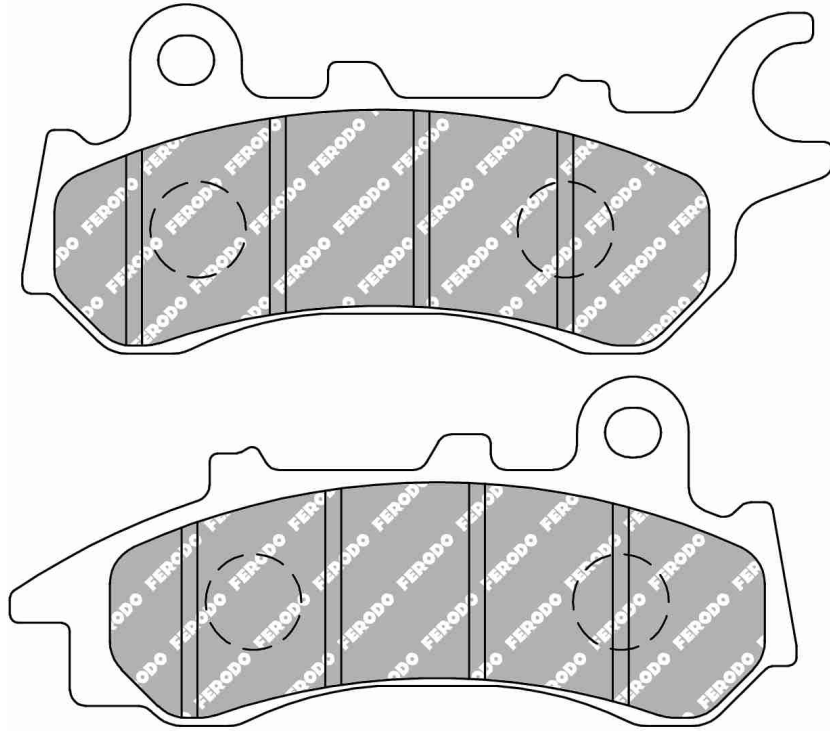

CROSS REFERENCE	
EBC	FA716



HONDA

S CB 125 F (GLR) 1WHH

CC	KW	FROM TO		FRONT	LEFT
				REAR	RIGHT
125		2017		F	

FDB2314

94.1 x 33.1 x 8 mm / 94.1 x 33.1 x 8 mm

MATERIAL AVAILABILITY											
AG	EF	P	PRP	ST	SM	SG	ZR	XRAC	ZRAC	CP1	CPRO
	✓										

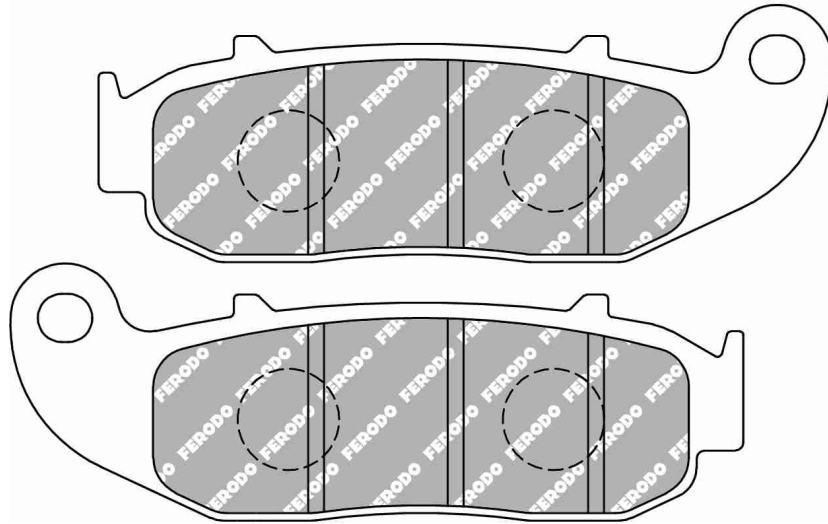

CROSS REFERENCE	
EBC	FA664
NEWFREN	FD0511
SBS	926

		CC	KW	FROM	TO	FRONT / REAR	LEFT / RIGHT
	FANTIC						
	M Caballero Motard	50		2010		F	
	M Caballero Regularita'	50		2010		F	
	M Caballero Motard 4T	125		2010		F	
	M Caballero Regularita' 4T	125		2010		F	

		CC	KW	FROM	TO	FRONT / REAR	LEFT / RIGHT
	M Regularita' Competizione	125		2008		F	
	M Caballero Motard 4T	200		2010		F	
	M Caballero Regularita' 4T	200		2010		F	

FDB2315

117.4 x 50.5 x 8.1 mm / 95.2 x 50.5 x 8.1 mm

MATERIAL AVAILABILITY											
AG	EF	P	PRP	ST	SM	SG	ZR	XRAC	ZRAC	CP1	CPRO
						✓					

CROSS REFERENCE	
EBC	FA682

		CC	KW	FROM	TO	FRONT / REAR	LEFT / RIGHT
	CAN AM ATV						
	A Defender 799	799		2016		F	left
	A Defender DPS 799	799		2016		F	left
	A Defender XT 799	799		2016		F	left
	A Defender XT Cab 799	799		2016		F	left
	A Maverick X3	900		2017		F	left
	A Maverick X3	900		2017		R	left
	A Maverick X3 Max Turbo	900		2017		F	left
	A Maverick X3 Max Turbo	900		2017		R	left
A Maverick X3 Turbo	900		2018		F	left	

		CC	KW	FROM	TO	FRONT / REAR	LEFT / RIGHT
	A Maverick X3 Turbo	900		2018		R	left
	A Maverick X3 Turbo R	900		2018		F	left
	A Maverick X3 Turbo R	900		2018		R	left
	A Maverick X3 Max Turbo R	900		2018		F	left
	A Maverick X3 Max Turbo R	900		2018		R	left
	A Defender 976	976		2016		F	left
	A Defender DPS 976	976		2016		F	left
	A Defender XT 976	976		2016		F	left
	A Defender XT Cab 976	976		2016		F	left

M = MOTORCYCLE
S = SCOOTER
A = ATV
Sn = SNOWMOBILE

FDB2316

117.4 x 50.5 x 8.1 mm / 95.2 x 50.5 x 8.1 mm

MATERIAL AVAILABILITY

AG	EF	P	PRP	ST	SM	SG	ZR	XRAC	ZRAC	CP1	CPRO
						✓					

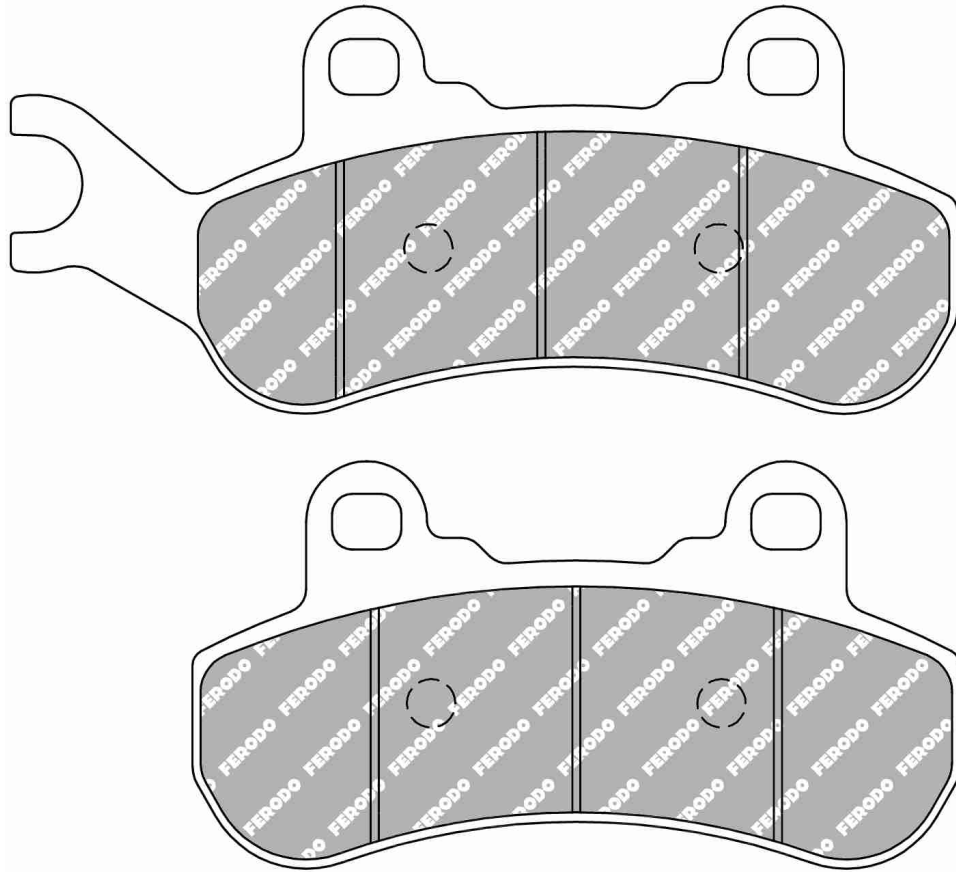

CROSS REFERENCE

EBC	FA683
-----	-------

		CC	KW	FROM	TO	FRONT REAR	LEFT RIGHT
	CAN AM ATV						
	A Defender 799	799		2016		F	right
	A Defender DPS 799	799		2016		F	right
	A Defender XT 799	799		2016		F	right
	A Defender XT Cab 799	799		2016		F	right
	A Maverick X3	900		2017		F	right
	A Maverick X3	900		2017		R	right
	A Maverick X3 Max Turbo	900		2017		F	right
	A Maverick X3 Max Turbo	900		2017		R	right
A Maverick X3 Turbo	900		2018		F	right	

		CC	KW	FROM	TO	FRONT REAR	LEFT RIGHT
	A Maverick X3 Turbo	900		2018		R	right
	A Maverick X3 Turbo R	900		2018		F	right
	A Maverick X3 Turbo R	900		2018		R	right
	A Maverick X3 Max Turbo R	900		2018		F	right
	A Maverick X3 Max Turbo R	900		2018		R	right
	A Defender 976	976		2016		F	right
	A Defender DPS 976	976		2016		F	right
	A Defender XT 976	976		2016		F	right
	A Defender XT Cab 976	976		2016		F	right

FDB2317

101.5 x 43 x 8.1 mm / 83.2 x 43 x 8.1 mm

MATERIAL AVAILABILITY											
AG	EF	P	PRP	ST	SM	SG	ZR	XRAC	ZRAC	CP1	CPRO
						✓					

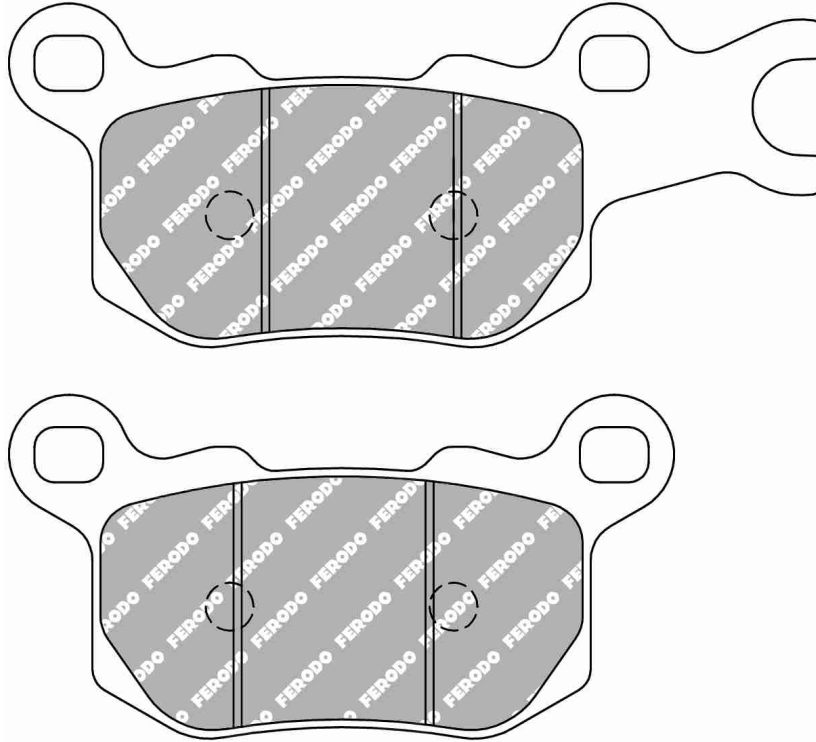

CROSS REFERENCE	
EBC	FA684

		CC	KW	FROM	TO	FRONT REAR	LEFT RIGHT
	CAN AM ATV						
A	Defender 799	799		2016		R	left
A	Defender DPS 799	799		2016		R	left
A	Defender XT 799	799		2016		R	left
A	Defender XT Cab 799	799		2016		R	left

		CC	KW	FROM	TO	FRONT REAR	LEFT RIGHT
							
A	Defender 976	976		2016		R	left
A	Defender DPS 976	976		2016		R	left
A	Defender XT 976	976		2016		R	left
A	Defender XT Cab 976	976		2016		R	left

M = MOTORCYCLE
S = SCOOTER
A = ATV
Sn = SNOWMOBILE

FDB2318

101.5 x 43 x 8.1 mm / 83.2 x 43 x 8.1 mm

MATERIAL AVAILABILITY											
AG	EF	P	PRP	ST	SM	SG	ZR	XRAC	ZRAC	CP1	CPRO
						✓					

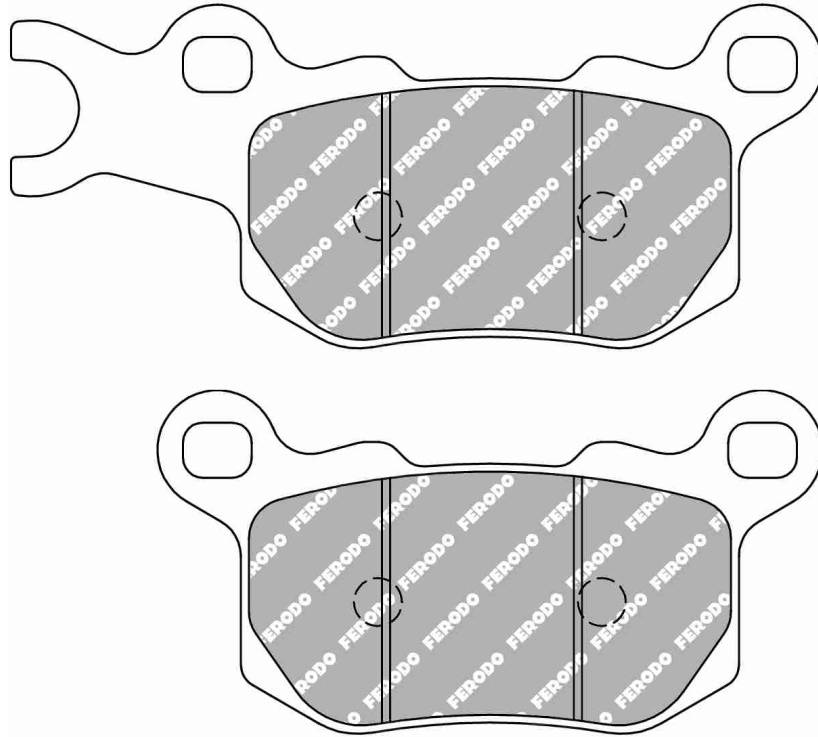

CROSS REFERENCE	
EBC	FA685

		CC	KW	FROM	TO	FRONT / RÉAR	LEFT / DROITE
 CAN AM ATV	A Defender 799	799		2016		R	right
	A Defender DPS 799	799		2016		R	right
	A Defender XT 799	799		2016		R	right
	A Defender XT Cab 799	799		2016		R	right

		CC	KW	FROM	TO	FRONT / RÉAR	LEFT / DROITE
 	A Defender 976	976		2016		R	right
	A Defender DPS 976	976		2016		R	right
	A Defender XT 976	976		2016		R	right
	A Defender XT Cab 976	976		2016		R	right

FDB2319

101.6 x 43.8 x 7.6 mm / 98.6 x 43.8 x 7.6 mm

MATERIAL AVAILABILITY											
AG	EF	P	PRP	ST	SM	SG	ZR	XRAC	ZRAC	CP1	CPRO
	✓										

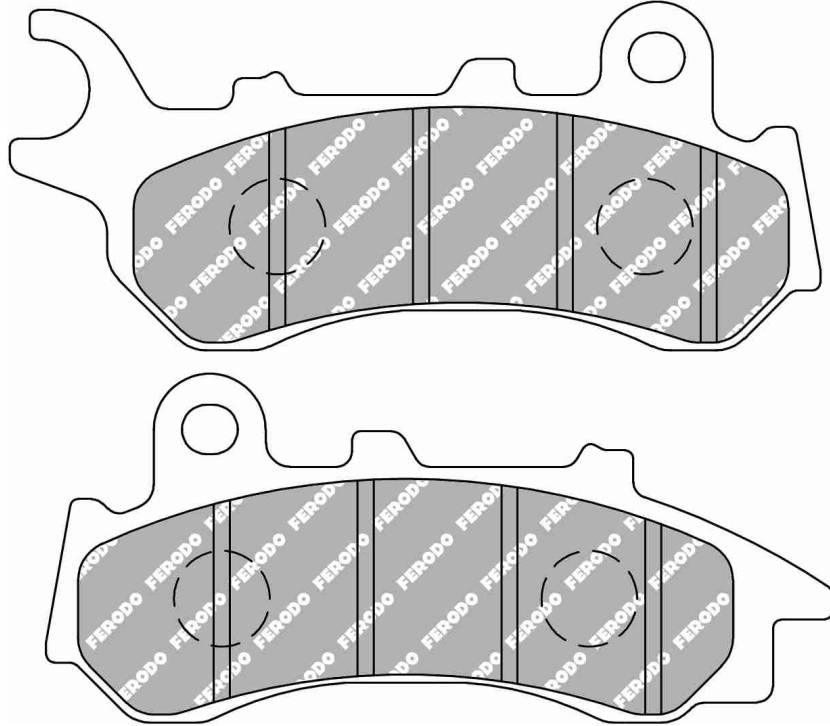

	HONDA	S	PCX 125	125	2018	FRONT	LEFT
						REAR	RIGHT
				CC	KW	FROM	TO
						F	

FDB2320

97.1 x 47.1 x 7.8 mm

MATERIAL AVAILABILITY											
AG	EF	P	PRP	ST	SM	SG	ZR	XRAC	ZRAC	CP1	CPRO
						✓					

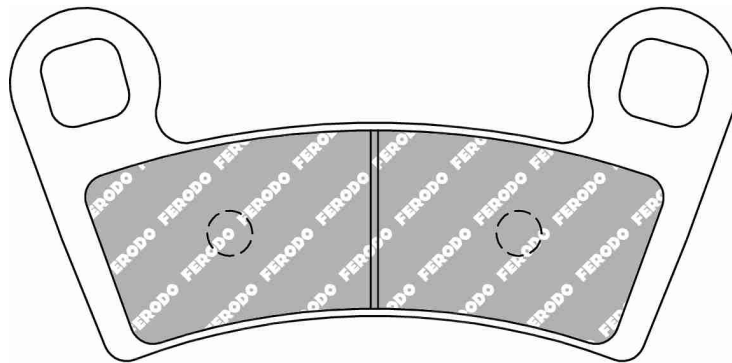

CROSS REFERENCE	
EBC	FA456
SBS	898

M = MOTORCYCLE
S = SCOOTER
A = ATV
Sn = SNOWMOBILE

		CC	KW	FROM	TO	FRONT / REAR	LEFT / RIGHT
POLARIS ATV	A	Outlaw S 450	450		2008		F
	A	Outlaw MXR 450	450		2009	2011	F
	A	Outlaw IRS 525	525		2008	2013	F

		CC	KW	FROM	TO	FRONT / REAR	LEFT / RIGHT
	A	Outlaw S 525	525		2008	2011	F
	A	RZR 570	570		2012	2014	F
	A	RZR 800 (EPS Models)	800		2008	2014	F

FDB2321

73.1 x 54.8 x 8.4 mm

MATERIAL AVAILABILITY											
AG	EF	P	PRP	ST	SM	SG	ZR	XRAC	ZRAC	CP1	CPRO
				✓				🔄			

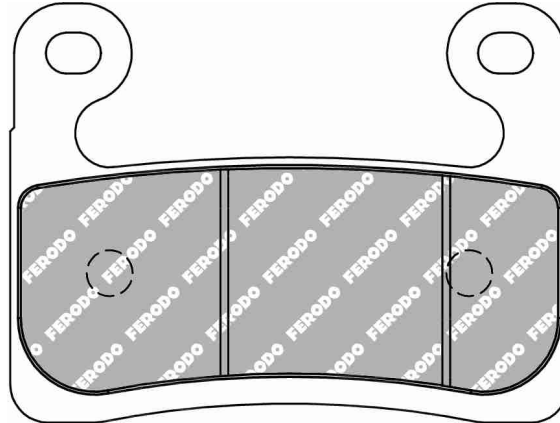

CROSS REFERENCE	
SBS	960

		CC	KW	FROM	TO	FRONT / REAR	LEFT / RIGHT
BMW	M	S 1000 XR	1000	121	2020		F
	M	S1000 RR	1000	152	2019		F
	M	R 1250 GS Adventure	1250	100	2019		F

		CC	KW	FROM	TO	FRONT / REAR	LEFT / RIGHT
	M	R 1250 RT	1250	100	2019		F
	M	R 1250 GS	1250	100	2019		F

FDB2322

70.6 x 59.8 x 9.1 mm

MATERIAL AVAILABILITY											
AG	EF	P	PRP	ST	SM	SG	ZR	XRAC	ZRAC	CP1	CPRO

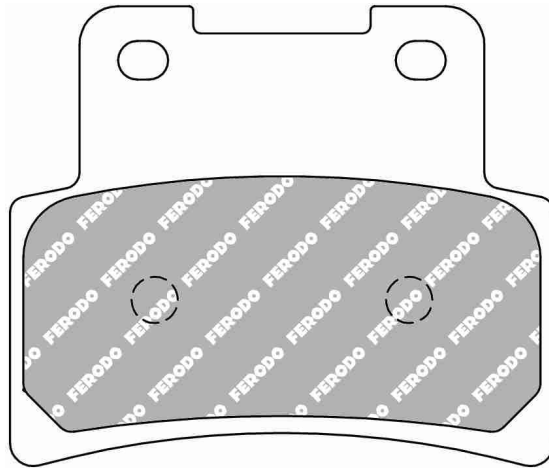

CROSS REFERENCE	
BREMBO	07100XS
GALFER	FD367
NEWFREN	FD0501
SBS	214

		CC	KW	FROM	TO	FRONT / REAR	LEFT / RIGHT
	S XCITING 400 i	400	26	2013		F	
	S XCITING 400 i ABS	400		2014		F	

		CC	KW	FROM	TO	FRONT / REAR	LEFT / RIGHT
	S XCITING 400 i R	400		2015		F	
	M XCITING 400 i S	400	26	2018		F	

FDB2323

94.1 x 34.0 x 7.6 mm

MATERIAL AVAILABILITY											
AG	EF	P	PRP	ST	SM	SG	ZR	XRAC	ZRAC	CP1	CPRO

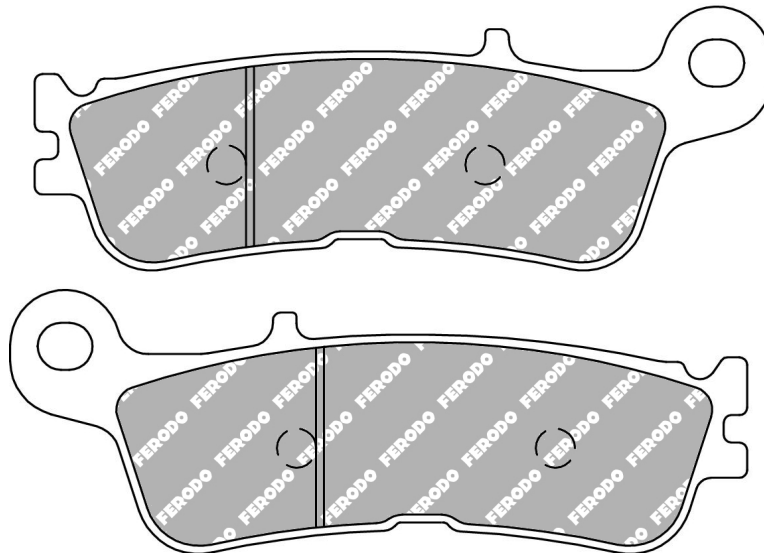

M = MOTORCYCLE
S = SCOOTER
A = ATV
Sn = SNOWMOBILE



		CC	KW	FROM	TO	FRONT / REAR	LEFT / RIGHT
YAMAHA	M YZ 450 F	450		2020		F	



SHOE DRAWINGS



FSB700 200.0 x 30.0 mm

REAR

Springs NOT included

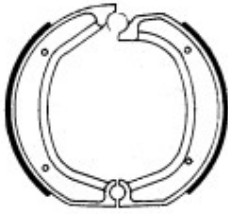

Drawing not in scale

FSB701 200.0 x 25.0 mm

REAR

Springs NOT included



Drawing not in scale

FSB702 80.0 x 18.0 mm

FRONT / REAR

Springs NOT included



Drawing not in scale

FSB703 95.0 x 20.0 mm

FRONT / REAR

Springs included



Drawing not in scale

FSB704 110.0 x 25.0 mm

FRONT / REAR

Springs included



Drawing not in scale

FSB705 110.0 x 25.0 mm

FRONT / REAR

Springs included

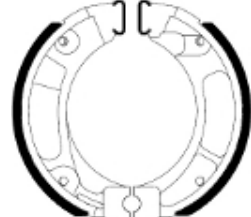

Drawing not in scale

FSB706 130.0 x 30.0 mm

REAR

Springs included



Drawing not in scale

FSB707 140.0 x 25.0 mm

FRONT / REAR

Springs included

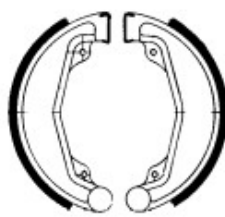

Drawing not in scale

FSB708 140.0 x 40.0 mm

REAR

Springs included



Drawing not in scale

FSB709 130.0 x 30.0 mm

REAR

Springs included

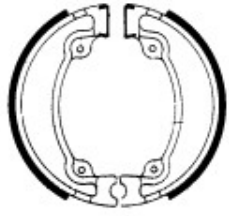

Drawing not in scale

FSB710 180.0 x 38.0 mm

REAR

Springs included



Drawing not in scale

FSB711 160.0 x 40.0 mm

REAR

Springs included



Drawing not in scale

For BUYER'S GUIDE see page 6000

For CROSS REFERENCES see pages 8000

FSB712 80.0 x 18.0 mm

FRONT / REAR

Springs included



Drawing not in scale

FSB714 95.0 x 20.0 mm

FRONT / REAR

Springs included



Drawing not in scale

FSB715 110.0 x 25.0 mm

FRONT / REAR

Springs included



Drawing not in scale

FSB716 110.0 x 30.0 mm

REAR

Springs included



Drawing not in scale

FSB717 120.0 x 35.0 mm

FRONT / REAR

Springs included



Drawing not in scale

FSB718 160.0 x 30.0 mm

REAR

Springs included



Drawing not in scale

FSB719 180.0 x 40.0 mm

REAR

Springs included



Drawing not in scale

FSB721 130.0 x 28.0 mm

FRONT / REAR

Springs included



Drawing not in scale

FSB722 110.0 x 30.0 mm

FRONT / REAR

Springs included



Drawing not in scale

FSB723 110.0 x 25.0 mm

FRONT / REAR

Springs included



Drawing not in scale

FSB724 150.0 x 28.0 mm

FRONT / REAR

Springs included



Drawing not in scale

FSB725 160.0 x 30.0 mm

REAR

Springs included



Drawing not in scale

For BUYER'S GUIDE see page 6000

For CROSS REFERENCES see pages 8000

FSB726 90.0 x 20.0 mm

FRONT / REAR

Springs included



Drawing not in scale

FSB727 80.0 x 20.0 mm

FRONT / REAR

Springs included

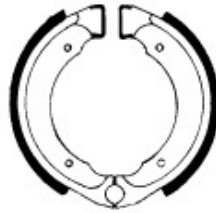

Drawing not in scale

FSB728 120.0 x 28.0 mm

FRONT / REAR

Springs included



Drawing not in scale

FSB729 120.0 x 30.0 mm

FRONT / REAR

Springs included



Drawing not in scale

FSB730 80.0 x 17.0 mm

FRONT / REAR

Springs NOT included



Drawing not in scale

FSB731 110.0 x 25.0 mm

FRONT / REAR

Springs included



Drawing not in scale

FSB732 110.0 x 25.0 mm

FRONT / REAR

Springs included



Drawing not in scale

FSB733 130.0 x 28.0 mm

FRONT / REAR

Springs included



Drawing not in scale

FSB734 150.0 x 25.0 mm

FRONT / REAR

Springs included



Drawing not in scale

FSB735 180.0 x 30.0 mm

REAR

Springs included



Drawing not in scale

FSB736 160.0 x 30.0 mm

REAR

Springs included



Drawing not in scale

FSB737 130.0 x 22.0 mm

FRONT / REAR

Springs included



Drawing not in scale

For BUYER'S GUIDE see page 6000

For CROSS REFERENCES see pages 8000

FSB738 110.0 x 25.0 mm

FRONT / REAR

Springs included

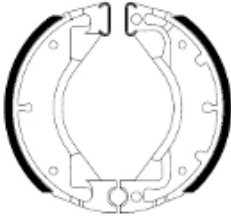

Drawing not in scale

FSB739 95.0 x 20.0 mm

FRONT / REAR

Springs included

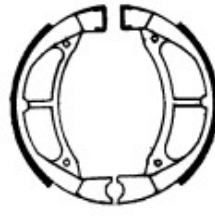

Drawing not in scale

FSB740 110.0 x 30.0 mm

REAR

Springs included



Drawing not in scale

FSB741 180.0 x 30.0 mm

REAR

Springs included



Drawing not in scale

FSB742 160.0 x 30.0 mm

REAR

Springs included



Drawing not in scale

FSB743 160.0 x 25.0 mm

FRONT / REAR

Springs included



Drawing not in scale

FSB744 130.0 x 30.0 mm

FRONT

Springs included



Drawing not in scale

FSB745 130.0 x 30.0 mm

FRONT / REAR

Springs included



Drawing not in scale

FSB746 130.0 x 22.0 mm

FRONT / REAR

Springs included

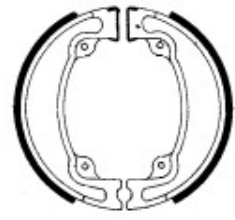

Drawing not in scale

FSB747 140.0 x 25.0 mm

FRONT

Springs included



Drawing not in scale

FSB748 130.0 x 25.0 mm

REAR

Springs included



Drawing not in scale

FSB749 140.0 x 30.0 mm

REAR

Springs included



Drawing not in scale

FSB750 150.0 x 25.0 mm

REAR

Springs included



Drawing not in scale

FSB751 130.0 x 25.0 mm

FRONT

Springs included



Drawing not in scale

FSB753 87.0 x 20.0 mm

FRONT

Springs included

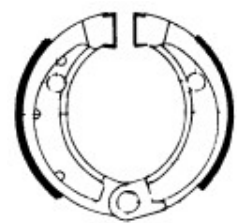

Drawing not in scale

FSB754 95.0 x 20.0 mm

FRONT / REAR

Springs included



Drawing not in scale

FSB755 140.0 x 30.0 mm

REAR

Springs included



Drawing not in scale

FSB756 85.0 x 20.0 mm

FRONT / REAR

Springs NOT included

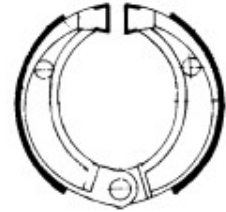

Drawing not in scale

FSB757 130.0 x 25.0 mm

REAR

Springs included



Drawing not in scale

FSB758 90.0 x 20.0 mm

FRONT

Springs included



Drawing not in scale

FSB759 140.0 x 25.0 mm

REAR

Springs included



Drawing not in scale

FSB760 140.0 x 28.0 mm

FRONT / REAR

Springs included



Drawing not in scale

FSB761 180.0 x 35.0 mm

REAR

Springs included



Drawing not in scale

FSB762 130.0 x 25.0 mm

FRONT / REAR

Springs included



Drawing not in scale

For BUYER'S GUIDE see page 6000

For CROSS REFERENCES see pages 8000

FSB763 130.0 x 22.0 mm

FRONT / REAR

Springs included



Drawing not in scale

FSB764 95.0 x 20.0 mm

FRONT / REAR

Springs included

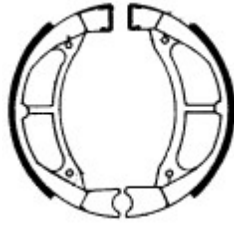

Drawing not in scale

FSB765 200.0 x 40.0 mm

REAR

Springs included



Drawing not in scale

FSB766 150.0 x 25.0 mm

FRONT

Springs included



Drawing not in scale

FSB767 160.0 x 25.0 mm

FRONT / REAR

Springs included



Drawing not in scale

FSB768 118.0 x 24.0 mm

REAR

Springs NOT included



Drawing not in scale

FSB769 180.0 x 40.0 mm

REAR

Springs included



Drawing not in scale

FSB770 180.0 x 30.0 mm

FRONT

Springs included



Drawing not in scale

FSB772 130.0 x 28.0 mm

FRONT / REAR

Springs included



Drawing not in scale

FSB773 180.0 x 28.0 mm

REAR

Springs included



Drawing not in scale

FSB775 130.0 x 23.0 mm

FRONT / REAR

Springs included



Drawing not in scale

FSB776 130.0 x 22.0 mm

FRONT / REAR

Springs included



Drawing not in scale

For BUYER'S GUIDE see page 6000

For CROSS REFERENCES see pages 8000

FSB777 120.0 x 25.0 mm

FRONT / REAR

Springs included

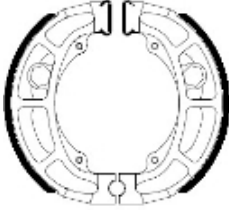

Drawing not in scale

FSB778 130.0 x 22.0 mm

FRONT

Springs included



Drawing not in scale

FSB779 150.0 x 22.0 mm

FRONT / REAR

Springs included



Drawing not in scale

FSB780 180.0 x 32.0 mm

REAR

Springs included



Drawing not in scale

FSB781 160.0 x 30.0 mm

REAR

Springs included



Drawing not in scale

FSB782 180.0 x 40.0 mm

REAR

Springs included

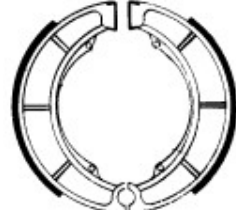

Drawing not in scale

FSB784 180.0 x 36.0 mm

REAR

Springs included



Drawing not in scale

FSB785 140.0 x 28.0 mm

FRONT / REAR

Springs included



Drawing not in scale

FSB786 120.0 x 22.0 mm

REAR

Springs included



Drawing not in scale

FSB787 130.0 x 28.0 mm

FRONT / REAR

Springs NOT included



Drawing not in scale

FSB790 160.0 x 30.0 mm

REAR

Springs included

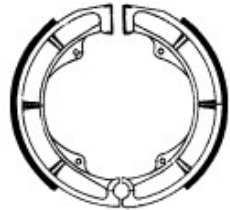

Drawing not in scale

FSB792 90.0 x 20.0 mm

FRONT / REAR

Springs included



Drawing not in scale

For BUYER'S GUIDE see page 6000

For CROSS REFERENCES see pages 8000

FSB793 180.0 x 30.0 mm

REAR

Springs included



Drawing not in scale

FSB794 180.0 x 35.0 mm

REAR

Springs NOT included



Drawing not in scale

FSB795 200.0 x 35.0 mm

REAR

Springs included



Drawing not in scale

FSB796 220.0 x 25.0 mm

FRONT / REAR

Springs NOT included



Drawing not in scale

FSB797 120.0 x 28.0 mm

FRONT / REAR

Springs included



Drawing not in scale

FSB799 140.0 x 28.0 mm

FRONT / REAR

Springs included



Drawing not in scale

FSB800 180.0 x 30.0 mm

FRONT

Springs included



Drawing not in scale

FSB802 90.0 x 20.0 mm

FRONT / REAR

Springs included

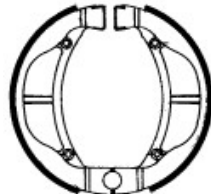

Drawing not in scale

FSB804 200.0 x 25.0 mm

REAR

Springs NOT included



Drawing not in scale

FSB805 200.0 x 23.0 mm

REAR

Springs NOT included



Drawing not in scale

FSB806 200.0 x 30.0 mm

FRONT

Springs NOT included



Drawing not in scale

FSB807 125.0 x 25.0 mm

FRONT / REAR

Springs included



Drawing not in scale

For BUYER'S GUIDE see page 6000

For CROSS REFERENCES see pages 8000

FSB809 105.0 x 25.0 mm

FRONT / REAR
Springs NOT included



Drawing not in scale

FSB812 160.0 x 30.0 mm

FRONT / REAR
Springs included



Drawing not in scale

FSB813 160.0 x 25.0 mm

FRONT
Springs NOT included



Drawing not in scale

FSB814 130.0 x 30.0 mm

FRONT / REAR
Springs included



Drawing not in scale

FSB815 181.0 x 25.0 mm

FRONT / REAR
Springs included



Drawing not in scale

FSB817 140.0 x 25.0 mm

FRONT
Springs included



Drawing not in scale

FSB818 158.0 x 30.0 mm

FRONT / REAR
Springs included



Drawing not in scale

FSB819 160.0 x 30.0 mm

REAR
Springs included



Drawing not in scale

FSB820 110.0 x 30.0 mm

FRONT / REAR
Springs included



Drawing not in scale

FSB823 160.0 x 30.0 mm

FRONT / REAR
Springs included



Drawing not in scale

FSB824 140.0 x 30.0 mm

FRONT / REAR
Springs included



Drawing not in scale

FSB825 122.0 x 30.0 mm

FRONT / REAR
Springs included



Drawing not in scale

For BUYER'S GUIDE see page 6000

For CROSS REFERENCES see pages 8000

FSB826 110.0 x 25.0 mm

FRONT / REAR

Springs included



Drawing not in scale

FSB827 120.0 x 25.0 mm

FRONT / REAR

Springs included



Drawing not in scale

FSB828 150.0 x 30.0 mm

REAR

Springs NOT included



Drawing not in scale

FSB834 124.0 x 28.0 mm

FRONT / REAR

Springs included



Drawing not in scale

FSB835 150.0 x 25.0 mm

REAR

Springs included



Drawing not in scale

FSB836 120.0 x 25.0 mm

FRONT / REAR

Springs included



Drawing not in scale

FSB837 124.0 x 25.0 mm

FRONT / REAR

Springs included



Drawing not in scale

FSB838 140.0 x 25.0 mm

REAR

Springs included



Drawing not in scale

FSB839 152.0 x 25.0 mm

FRONT / REAR

Springs NOT included



Drawing not in scale

FSB841 130.0 x 25.0 mm

REAR

Springs included



Drawing not in scale

FSB842 150.0 x 22.0 mm

FRONT / REAR

Springs NOT included



Drawing not in scale

FSB843 152.0 x 25.0 mm

FRONT / REAR

Springs NOT included



Drawing not in scale

FSB844 125.0 x 22.0 mm

REAR

Springs included



Drawing not in scale

FSB845 130.0 x 30.0 mm

REAR

Springs NOT included



Drawing not in scale

FSB846 125.0 x 26.0 mm

REAR

Springs included



Drawing not in scale

FSB847 136.0 x 25.0 mm

FRONT / REAR

Springs included

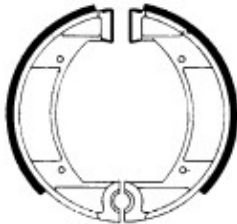

Drawing not in scale

FSB849 160.0 x 25.0 mm

FRONT / REAR

Springs included



Drawing not in scale

FSB850 162.0 x 25.0 mm

FRONT / REAR

Springs included



Drawing not in scale

FSB851 140.0 x 30.0 mm

FRONT

Springs NOT included



Drawing not in scale

FSB852 150.0 x 25.0 mm

REAR

Springs included



Drawing not in scale

FSB853 180.0 x 35.0 mm

REAR

Springs included



Drawing not in scale

FSB854 160.0 x 35.0 mm

FRONT / REAR

Springs included



Drawing not in scale

FSB855 160.0 x 35.0 mm

FRONT

Springs included



Drawing not in scale

FSB856 140.0 x 25.0 mm

FRONT / REAR

Springs NOT included



Drawing not in scale

For BUYER'S GUIDE see page 6000

For CROSS REFERENCES see pages 8000

FSB857 140.0 x 30.0 mm

FRONT / REAR

Springs included



Drawing not in scale

FSB860 120.0 x 24.0 mm

FRONT / REAR

Springs NOT included



Drawing not in scale

FSB861 140.0 x 35.0 mm

FRONT / REAR

Springs NOT included



Drawing not in scale

FSB862 110.0 x 25.0 mm

REAR

Springs included



Drawing not in scale

FSB863 200.0 x 27.0 mm

REAR

Springs NOT included



Drawing not in scale

FSB867 105.0 x 25.0 mm

FRONT / REAR

Springs included



Drawing not in scale

FSB869 150.0 x 25.0 mm

FRONT

Springs included

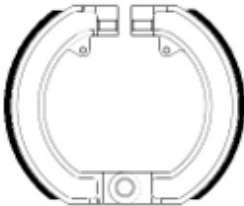

Drawing not in scale

FSB870 90.0 x 20.0 mm

FRONT

Springs included



Drawing not in scale

FSB871 90.0 x 20.0 mm

FRONT / REAR

Springs included



Drawing not in scale

FSB872 190.0 x 47.0 mm

FRONT / REAR

Springs NOT included; 6 shoes/box (2 with lever)



Drawing not in scale

FSB873 127.0 x 23.0 mm

REAR

Springs included



Drawing not in scale

FSB874 150.0 x 24.0 mm

FRONT / REAR

Springs included



Drawing not in scale

FSB875 127.0 x 23.0 mm

REAR

Springs included



Drawing not in scale

FSB876 160.0 x 30.0 mm

REAR

Springs included



Drawing not in scale

FSB877 90.0 x 18.0 mm

FRONT / REAR

Springs NOT included



Drawing not in scale

FSB878 180.0 x 41.0 mm

FRONT / REAR

Springs NOT included; 6 shoes/box (2 with lever)



Drawing not in scale

FSB879 127.0 x 28.0 mm

REAR

Springs included



Drawing not in scale

FSB880 220.0 x 40.0 mm

FRONT

Springs NOT included



Drawing not in scale

FSB881 220.0 x 40.0 mm

REAR

Springs included



Drawing not in scale

FSB883 110.0 x 23.0 mm

REAR

Springs included



Drawing not in scale

FSB885 135.0 x 20.0 mm

REAR

Springs included



Drawing not in scale

FSB886 160.0 x 32.0 mm

REAR

Springs NOT included; 4 shoes/box (2 with lever)

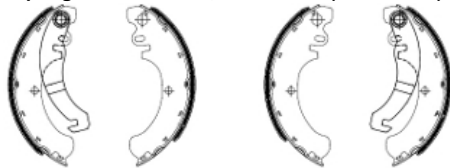

Drawing not in scale

FSB887 150.0 x 24.0 mm

REAR

Springs NOT included



Drawing not in scale

FSB888 190.0 x 18.0 mm

REAR

Springs NOT included



Drawing not in scale

For BUYER'S GUIDE see page 6000

For CROSS REFERENCES see pages 8000

FSB889 135.0 x 16.0 mm

REAR

Springs NOT included



Drawing not in scale

FSB890 125.0 x 17.0 mm

FRONT

Springs NOT included; 2 shoes/box



Drawing not in scale

FSB891 150.0 x 24.0 mm

REAR

Piastrine tipo U include



Drawing not in scale

FSB892 170.0 x 25.0 mm

REAR

Springs NOT included



Drawing not in scale

FSB893 170.0 x 25.0 mm

FRONT

Springs NOT included



Drawing not in scale

FSB894 110.0 x 25.0 mm

FRONT

Springs included



Drawing not in scale

FSB895 100.0 x 20.0 mm

REAR

Springs included



Drawing not in scale

FSB896 110.0 x 22.0 mm

FRONT / REAR

Springs included

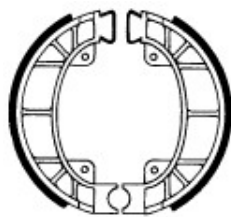

Drawing not in scale

FSB897 123.0 x 25.0 mm

FRONT / REAR

Springs included



Drawing not in scale

FSB898 125.0 x 25.0 mm

FRONT / REAR

Springs included



Drawing not in scale

FSB901 140.0 x 25.0 mm

FRONT / REAR

Springs included



Drawing not in scale

FSB902 90.0 x 18.0 mm

FRONT / REAR

Springs included



Drawing not in scale

FSB904 125.0 x 25.0 mm

FRONT / REAR
Springs NOT included



Drawing not in scale

FSB905 123.0 x 25.0 mm

REAR
Springs included



Drawing not in scale

FSB906 104.0 x 22.0 mm

FRONT
Springs included



Drawing not in scale

FSB907 118.0 x 20.0 mm

FRONT / REAR
Springs included



Drawing not in scale

FSB908 90.0 x 18.0 mm

FRONT / REAR
Springs included



Drawing not in scale

FSB909 125.0 x 25.0 mm

REAR
Springs included



Drawing not in scale

FSB910 105.0 x 20.0 mm

FRONT / REAR
Springs included



Drawing not in scale

FSB911 125.0 x 25.0 mm

FRONT / REAR
Springs included

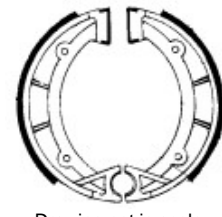

Drawing not in scale

FSB912 150.0 x 18.0 mm

REAR
Springs included



Drawing not in scale

FSB913 130.0 x 22.0 mm

FRONT
Springs included



Drawing not in scale

FSB914 110.0 x 25.0 mm

FRONT
Springs included



Drawing not in scale

FSB915 104.0 x 20.0 mm

FRONT / REAR
Springs included



Drawing not in scale

For BUYER'S GUIDE see page 6000

For CROSS REFERENCES see pages 8000

FSB916 138.0 x 25.0 mm

FRONT / REAR

Springs included

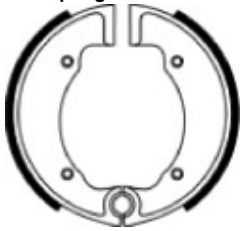

Drawing not in scale

FSB917 127.0 x 16.0 mm

FRONT / REAR

Springs NOT included



Drawing not in scale

FSB918 150.0 x 22.0 mm

FRONT / REAR

Springs NOT included



Drawing not in scale

FSB919 180.0 x 25.0 mm

FRONT

Springs included



Drawing not in scale

FSB920 200.0 x 30.0 mm

FRONT

Springs NOT included



Drawing not in scale

FSB921 200.0 x 40.0 mm

REAR

Springs included



Drawing not in scale

FSB922 180.0 x 30.0 mm

REAR

Springs included



Drawing not in scale

FSB923 200.0 x 30.0 mm

FRONT

Springs NOT included



Drawing not in scale

FSB924 180.0 x 28.0 mm

REAR

Springs NOT included



Drawing not in scale

FSB925 160.0 x 30.0 mm

FRONT

Springs NOT included

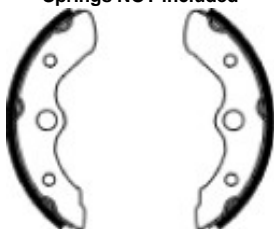

Drawing not in scale

FSB928 160.0 x 30.0 mm

FRONT

Springs included

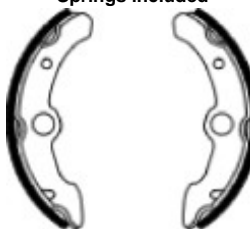

Drawing not in scale

FSB929 180.0 x 30.0 mm

FRONT

Springs included

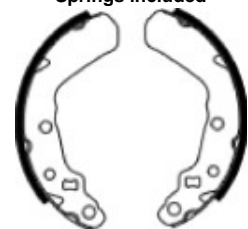

Drawing not in scale

FSB931 160.0 x 20.0 mm

FRONT

Springs included



Drawing not in scale

FSB932 160.0 x 30.0 mm

FRONT

Springs included

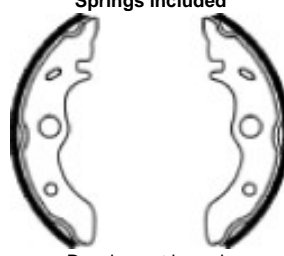

Drawing not in scale

FSB933 160.0 x 25.0 mm

FRONT

Springs included

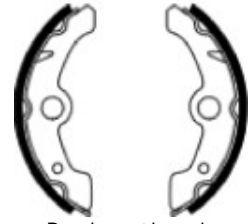

Drawing not in scale

FSB936 85.0 x 20.0 mm

FRONT

Springs NOT included



Drawing not in scale

FSB937 80.0 x 16.0 mm

FRONT / REAR

Springs NOT included



Drawing not in scale

FSB938 110.0 x 25.0 mm

FRONT / REAR

Springs included



Drawing not in scale

FSB939 125.0 x 25.0 mm

FRONT

Springs included



Drawing not in scale

FSB940 100.0 x 20.0 mm

REAR

Springs included



Drawing not in scale

FSB941 110.0 x 25.0 mm

REAR

Springs included



Drawing not in scale

FSB942 160.0 x 25.0 mm

FRONT

Springs included



Drawing not in scale

FSB943 180.0 x 30.0 mm

FRONT

Springs included



Drawing not in scale

FSB945 130.0 x 25.0 mm

FRONT

Springs NOT included



Drawing not in scale

For BUYER'S GUIDE see page 6000

For CROSS REFERENCES see pages 8000

FSB946 160.0 x 30.0 mm

REAR

Springs included



Drawing not in scale

FSB947 130.0 x 28.0 mm

FRONT / REAR

Springs included



Drawing not in scale

FSB948 159.0 x 25.0 mm

FRONT / REAR

Springs included



Drawing not in scale

FSB951 150.0 x 18.0 mm

REAR

Springs NOT included



Drawing not in scale

FSB952 105.0 x 22.0 mm

FRONT / REAR

Springs included



Drawing not in scale

FSB954 140.0 x 25.0 mm

REAR

Springs included



Drawing not in scale

FSB955 180.0 x 25.0 mm

FRONT / REAR

Springs NOT included

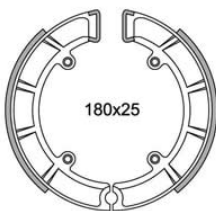

Drawing not in scale

FSB956 130.0 x 20.0 mm

REAR

Springs included

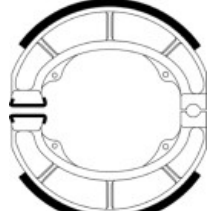

Drawing not in scale

FSB957 130.0 x 28.0 mm

REAR

Springs included

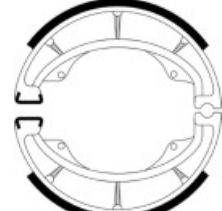

Drawing not in scale

FSB958 130.0 x 25.0 mm

FRONT / REAR

Springs included



Drawing not in scale

FSB959 150.0 x 30.0 mm

REAR

Springs included



Drawing not in scale

FSB960 130.0 x 28.0 mm

REAR

Springs included



Drawing not in scale

FSB963 130.0 x 25.0 mm

FRONT / REAR

Springs included



Drawing not in scale

FSB964 130.0 x 28.0 mm

REAR

Springs included



Drawing not in scale

FSB966 130.0 x 28.0 mm

REAR

Springs NOT included



Drawing not in scale

FSB967 150.0 x 28.0 mm

REAR

Springs included



Drawing not in scale

FSB970 130.0 x 25.0 mm

FRONT / REAR

Special Production Price and Delivery Available on Request



Drawing not in scale

FSB971 110.0 x 30.0 mm

FRONT / REAR

Special Production Price and Delivery Available on Request

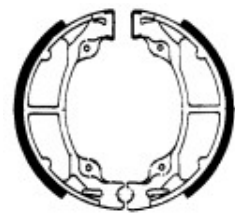

Drawing not in scale

FSB973 130.0 x 28.0 mm

FRONT / REAR

Special Production Price and Delivery Available on Request



Drawing not in scale

FSB974 130.0 x 28.0 mm

REAR

Special Production Price and Delivery Available on Request

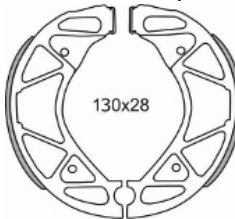

Drawing not in scale

FSB975 110.0 x 25.0 mm

FRONT / REAR

Special Production Price and Delivery Available on Request



Drawing not in scale

FSB977 130 x 28 mm

FRONT / REAR



Drawing not in scale

FSB978 160.0 x 25.0 mm

FRONT / REAR



Drawing not in scale

FSB979 130.0 x 28.0 mm

FRONT / REAR

Special Production Price and Delivery Available on Request

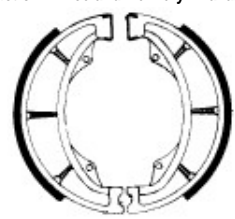

Drawing not in scale

For BUYER'S GUIDE see page 6000

For CROSS REFERENCES see pages 8000

FSB982

190.0 x 47.0 mm

FRONT

Springs NOT included; 4 shoes/box

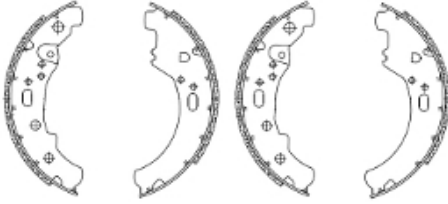

Drawing not in scale

FSB983

190.0 x 47.0 mm

REAR

Springs NOT included; 4 shoes/box (2 with lever)

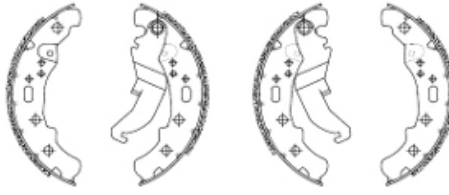

Drawing not in scale

FSB4016

203.2 x 38 mm

REAR

Springs included - Old code FSB965

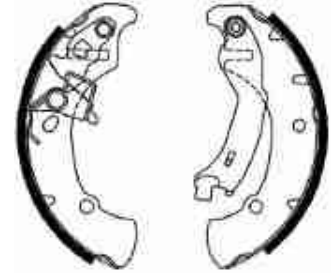

Drawing not in scale



A black and white photograph of a hand pointing at a document. The hand is in the foreground, pointing towards the right. The document is in the background, with some text visible but out of focus. The lighting is dramatic, with strong highlights and deep shadows.

FERODO[®]

SHOE BUYER'S GUIDE

FERODO[®]

MOTORCYCLE



CC FROM TO FRONT / REAR

Code	Brand	Model	CC	FROM	TO	FRONT / REAR			
FSB4016	PIAGGIO (motocarr)	M PORTER Box 1.0	993	1993	1998	R			
		M PORTER Platform/Chassis 1.0	993	1993	1994	R			
		M PORTER Box 1.0	993	1994	2017	R			
		M PORTER Platform/Chassis 1.0	993	1994		R			
		M PORTER Box 1.2 D	1221	1995		R			
		M PORTER Platform/Chassis 1.2 D	1221	1995		R			
		M PORTER Box 1.3 i 16V	1295	1998		R			
		M PORTER Box 1.3 i 16V 4x4	1295	1998		R			
		M PORTER Platform/Chassis 1.3 i 16V	1295	1998		R			
		M PORTER Platform/Chassis 1.3 i 16V 4x4	1295	1998		R			
		M PORTER Box 1.4 D	1371	1998		R			
		M PORTER Platform/Chassis 1.4 D	1371	1998		R			
		FSB700	BMW	M R 45 450	450	1978	1981	R	
M R 50/5 500	500			1969	1975	R			
M R 60/5 600	600				1975	R			
M R 60/6 600	600				1975	R			
M R 60/7 600	600			1976	1978	R			
M R 65 650	650				1980	R			
M R 75/5 750	750				1975	R			
M R 75/6 750	750			1975	1979	R			
M R 80 800 all models	800			1977	1981	R			
M R 90 900 S	900			1973	1976	R			
M R 90/6 900	900			1973	1976	R			
M R 100 1000 all models	1000				1981	R			
FSB701	BMW			M R 45 450	450	1981	1985	R	
		M R 65 650 LS	650	1981	1985	R			
		M R 65 650 GS	650	1987	1988	R			
		M R 65 650	650	1989	2000	R			
		M R 65 650 GS	650	1989	1992	R			
		M R 80 800 GS / PARIS-DAKAR	800	1981	1986	R			
		M R 80 800 all models	800	1982	1984	R			
		M R 80 800 all models	800	1985	1989	R			
		M R 80 800 GS / PARIS-DAKAR	800	1987	1995	R			
		M R 80 800 all models	800	1989	1995	R			
		M R 80 RT	800	1990	1994	R			
		M R 100 1000 all models	1000	1981	1989	R			
		M R 100 1000 GS / PARIS-DAKAR	1000	1987	1994	R			
FSB702	HONDA	M CRF 50 F	50	2004		F/R			
		M NB 50 DELUX	50	1982		F			
		M NB 50 MELODY	50	1982		F			
		M NB 50 MSB	50	1982		F			
		M NB 50	50	1985		F			
		M NC 50 KI	50	1979		F/R			
		M NC 50 Z EXPRESS	50	1979		F/R			
		M NC 50 A	50	1982		F/R			
		M NC 50 B	50	1982		F/R			
		M NC 50 C	50	1982		F/R			
		M NC 50 EXPRESS 2	50	1982		F/R			
		M NC 50 EXPRESS 3	50	1982		F/R			
		M ND 50	50	1982		F			
		M ND 50 MELODY 2 all models	50	1982		F			
		M NE 50 VISION	50	1985		F			
	M NP 50 D MELODY MINI	50	1983		F				
	M NX 50	50	1981	1982	F				
	M OR 50	50	1993		F				
	M PC 50 KI	50	1979		F/R				
	M QR 50 ED	50	1982	1990	F				
	M QR 50	50	1993		F				
	M SA 50 ELITE LX	50	1988	1990	F				
	M XR 50 R	50	2000		F/R				
	M Z 50 all models	50	1979	1991	F/R				
	PEUGEOT	M ST 50	50			F			
		M STL 2 50	50			F			
		M DR-Z 70	70	2008		F/R			
		YAMAHA	M TT-R 50	50	2006	2013	F/R		
			FSB703	HERCULES (SACHS)	M LIMBO 50	50	1993		F
					M NB 50 DELUX	50	1982		R
					M NB 50 MELODY	50	1982		R
					M NB 50 MSB	50	1982		R
		M NB 50			50	1985		R	
M ND 50	50	1982				R			
HONDA	M ND 50 MELODY 2 all models	50		1982		R			
	M NE 50 VISION	50		1985		R			
	S NH 50 LEAD	50			1987	R			
	S NH 50 LEAD	50		1988	1992	R			
	S NH 50 LEAD	50		1993	1994	R			
	S NH 50 LEAD	50		1994		R			
M NP 50 D MELODY MINI	50	1983		R					
S NU 50 M RUNAWAY	50	1982	1983	R					
S NV 50 MSD STREAM	50	1984		F/R					



CC FROM TO FRONT / REAR

Code	Brand	Model	CC	FROM	TO	FRONT / REAR
FSB704	PEUGEOT	M NX 50	50	1981	1982	R
		M OR 50	50	1993		R
		M PX 50 all models	50	1982	1983	R
		M QR 50 ED	50	1982	1990	R
		M SA 50 ELITE LX	50	1988	1990	R
		S NH 80 LEAD	80	1983	1987	R
		S NH 80 LEAD AERO	80	1983	1985	R
		S NH 80 LEAD	80	1988		R
		M METROPOLIS 50	50			R
		M SC 50	50			R
		M ST 50	50			R
		M STL 2 50	50			R
	PGO	M SC 75	75			R
		M SX 75	75			R
		M METROPOLIS 80	80			R
		M SX 80	80			R
		M STAR 50	50		1993	R
		M STAR 2 50	50	1994		R
		M BIG MAX 80	80			R
		M STAR 80	80	1990		R
	SYM	M FIDDLE 50	50	1999		R
		APRILIA	M AMICO 50	50	1990	1991
	M AMICO 50 all models		50	1992		R
	M GULLIVER 50		50	1995	1998	R
M RALLY 50 air cooled	50		1995	2002	R	
S SCARABEO 50	50		1994	1995	R	
S SCARABEO 50 / 50 Street 4T-2T	50		1996		R	
S SONIC 50 SPICE	50		1997		R	
S SONIC 50 GP	50		1997		R	
S SR 50 all models	50		1993	1996	R	
M CAROSELLO 50	50		1997		R	
M 491 50 GT	50		1997		R	
BETA	M K2 50 all models		50	1998	2001	R
	M PEPE 50/50 LX/Classic (7 Spoke Cast Wheel)	50	1999	2013	R	
	S Pepe 50 (5 Spoke Cast Wheel/2T/4T)	50	2010	2012	R	
	M CH 50	50	1996		R	
	M CHRONO 50	50	1992	1994	R	
	M CHRONO 50	50	1994		R	
	M CHRONO 50 13	50	1994		R	
	M CHRONO 50 502	50	1997		R	
	M QUADRA 50	50	1995		R	
	M TEMPO 50	50	1993		R	
	BS VILLA	M AX 50	50	1993		R
		M GZ 50	50	1993		R
CAGIVA		M CITY 50	50	1992	1994	R
		M CITY 50	50	1995		R
E-TON ATV		M PASSING 125	125	1993	1997	R
		A CXL 150 Yukon II/Challenger	150	2002	2009	F
	A CXL150	150	2002		F	
	A RXL 150 Viper R	150	2005	2009	F	
	A RXL 150 Viper	150	2005	2006	F	
	A YXL 150 Yukon	150	2000	2002	F	
HERCULES (SACHS)	M GIPSY 50	50	1993		R	
	M LIMBO 50	50	1993		R	
	M SAMBA SR 50	50	1993		F/R	
	M SAMBA SR 80	80	1993		R	
	M SAMBA SR 125	125	1993		R	
	M C 50 Z2 ZZ ZA	50	1975	1993	F/R	
	M CB 50 J all models	50	1981		F/R	
	M CF 50 CHALY	50	1979		F/R	
	M DAX 50	50	1993	1996	F/R	
	M MONKEY 50	50	1988		R	
	S NH 50 LEAD	50		1987	F	
	S NH 50 LEAD	50	1993	1994	F	
HONDA	S PK 50 WALLAROO DX - STD	50	1990	2001	R	
	M QA 50 K1/3	50	1987	1990	F/R	
	S SFX 50	50	1995		R	
	M SH 50 CITY EXPRESS	50	1984	1996	F	
	M SH 50 SCOOPY / FIFTY	50	1997	2003	R	
	M SJ 50 BALI	50	1993	1999	R	
	M SKY 50	50	1997		R	
	M SKY 50 VETRO	50	2000		R	
	M SS 50 ZK2	50	1975	1977	F/R	
	M SS 50 ZB2	50	1977	1980	R	
	M ST 50	50	1978	1993	F/R	
	M ST 50 DAX	50	1993	1996	F/R	
M VT 50 SHADOW	50	1998		R		
M C 70 all models	70	1975		F/R		
M CF 70 C	70	1978	1979	F/R		
M CF 70 K2	70	1978	1980	F/R		

6000

FERODO
RACING
Updated on November 2020

M = MOTORCYCLE
S = SCOOTER
A = ATV
Sn = SNOWMOBILE



CC FROM TO FRONT / REAR

...FSB704

M	DAX ST 70	70	1978	1980	F/R
M	NF 75	75	1979		F/R
M	SA 75 VISION	75	1988		F
M	SH 75 SCOOPY	75	1988	1995	F
M	XR 75 K5	75	1979		F
M	YUPY 75	75	1991		R
S	CH 80 ELITE/SPACY	80	1985	1990	F
M	MBX 80 (ESPANA)	80	1984		R
S	NH 80 LEAD	80	1983	1987	F
S	NH 80 LEAD AERO	80	1983	1985	F
M	SH 80 SCOOPY	80	1984		F
M	C 90	90	1975	1981	F/R
M	EZ 90 CUB	90	1990		F/R
M	VT 90 SHADOW	90	1998		R
M	H 100	100	1984	1992	F/R
M	SH 100 Scoopy	100	1996	2001	R
M	SJ 100 BALI - EX	100	1998	1999	R
M	SUPRA 100	100		1998	F/R
M	SUPRA 100	100	1999		R
M	CT 110	110	1980	1988	F
M	CG 125	125	1977	1984	F/R
M	CG 125	125	1985		R
S	CH 125 ELITE/SPACY	125	1983	1997	F/R
S	CH 125 ELITE/SPACY	125	1988		R
M	ANF 125 INNOVA	125	2003	2011	R
M	MTX 125 R	125	1987	1988	R
M	MTX 125 RII	125	1989		R
S	NH 125 LEAD	125	1983	1987	F/R
S	NH 125 LEAD	125	1988		R
M	NS 125 F	125	1985	1987	R
M	NS 125 R	125	1987	1990	R
M	NSR 125 R - F	125	1988	1990	R
M	NX 125 (ITALY)	125	1990		R
M	XL 125 K3	125	1979		F
M	XL 125 R	125	1984	1984	F/R
M	XL 125 S	125	1984	1984	F/R
M	CT 200 E - K	200	1984	1989	F
M	MTX 200 R	200	1987		R
M	XL 200 R	200	1985		R
M	XLR 250 R	250	1985	1988	R
HONDA 3 WHEELERS	A ATC 70	70	1976	1977	R
A	ATC 125	125	1984	1987	F
A	ATC 185	185	1980	1983	F
A	ATC 200 (Drum Brake)	200	1981	1986	F
HONDA ATV	A TRX 90	90	1993	2009	F
A	TRX 125 Fourtrax	125	1985	1988	F
HONDA-HM ITALIA	M CB 125	125	1979		R
M	DT 125	125	1987		R
M	MTX 125 R	125	1986		R
M	MTX 125 RALLY SPORT	125	1988		R
M	NS 125 F	125	1985		R
M	NS 125 R SUPER SPORT	125	1987		R
M	XL 125	125	1979		F/R
M	XL 125 PARIS DAKAR	125	1984	1985	F/R
M	XL 125 L PARIS DAKAR	125	1985		R
M	XL 125 R2	125	1987		R
M	XL 200 R	200	1983		F/R
M	XL 200 R PARIS DAKAR	200	1984		F/R
M	XL 200 L	200	1985		R
M	XL 200 L PARIS DAKAR	200	1987		R
M	XL 200 R2	200	1987		R
HUSQVARNA	M WRS 50 (SCOOTER)	50	1998	2000	R
KTM	M CHRONO 50 SCOOTER	50	1994		R
M	GO 50 SCOOTER	50	1994		R
KYMCO	S ACTIV 50	50	2005	2006	R
S	ACTIV 50 SR	50	2008	2011	R
S	AGILITY 50 (KG10SA)	50	2005	2008	R
S	AGILITY 50 R10 (4T)	50	2006		R
S	AGILITY 50 R12 (4T)	50	2006		R
S	AGILITY 50 Basic	50	2007	2007	F/R
S	AGILITY RS Naked 50 2T	50	2010		R
S	AGILITY Carry 50 (4T)	50	2011	2018	R
M	BET & WIN 50	50	2002	2006	R
M	COBRA 50 / RACER & CROSS	50	1999	2006	R
M	CURIO 50	50	1994		R
M	CX 50	50	1993		F
M	DINK / GRAND DINK 50 / New Dink	50	1997		R
S	DINK 50 (4T)	50	2007		R
M	DJX 50	50	1991	1992	F
M	DJY 50 / DJY 50 REFINED	50	1993		F



CC FROM TO FRONT / REAR

M	DJW 50	50	1994		F
S	DJS 50	50	2012	2013	R
M	FILLY 50	50	1998	2000	F/R
M	FILLY LX 50	50	2000		R
S	GRAND DINK 50 (2T)	50	2004	2007	R
S	G-DINK 50 (2T)	50	2012		R
M	HEROISM 50	50	1995	1997	R
M	KB 50	50	1994	2000	R
M	K 12 50	50	1995		R
S	LIKE LX 50 2T/4T	50	2010		R
M	MANBOY 50	50	1995		R
M	SCOUT 50	50	1998		R
S	SENTO 50	50	2008	2009	R
M	SPACER 50	50	1999		R
M	TOP BOY 50	50	1997	2000	R
M	TOP BOY 50	50	2000		R
S	VISA R	50	2011	2012	R
S	VITALITY 50 (2T & 4T)	50	2004	2009	R
M	COBRA 100 RACER	100	1999	2003	R
M	TOP BOY 100	100	1997		R
S	VISA R 110	110	2011	2011	R
M	LIBERO 111 4T	111	2008		R
S	ACTIV 110 / 125	125	2004	2006	R
S	AGILITY 125	125	2006	2008	R
S	AGILITY Carry 125 (4T)	125	2011	2016	R
M	FREEWAY 125	125	1997		F/R
M	HEROISM 125	125	1995	1997	R
M	FREEWAY 150	150	1997		F/R
M	HEROISM 150	150	1995	1997	R
KYMCO ATV	A MXer 50	50	2000	2007	F
A	MXU 50	50	2005	2013	F
A	MXU 150	150	2005	2012	F
MALAGUTI	M CENTRO 50	50		1992	R
M	CENTRO 50 SL	50	1993	1999	R
M	CENTRO 50 4T / SL 4T	50	2008		R
M	CIAK 50 / CIAK Master 4T 50	50	1999		R
M	F 10 50 JETLINE	50	1992	1993	R
M	F 10 50 JETLINE /F10 WAP JETLINE	50	1994		R
M	F 12 50 PHANTOM (liquid cooled)	50	1994		R
M	F 12 50 PHANTOM (liquid cooled)	50	1995	1997	R
M	F 15 50 FIREFOX	50	1996	1997	R
M	F12 R 50 PHANTOM (all air cooled models)	50	2007	2011	R
M	YESTERDAY 50	50	1998		R
PEUGEOT	S E-Vivacity (Electric)		2010		R
S	e - Vivacity (Electric)		2011	2012	R
M	BUXI 50	50	1994	1997	R
M	BUXI RS 50	50	1994	1997	R
M	ELYSEO 50	50	1998	2002	R
M	FOX 50	50	1996		R
S	Jet H2i 50 (2T -Air Cooled)	50	2011	2012	R
M	LOOXOR 50	50	2001		R
M	LUDIX ONE 50	50	2004		F/R
S	Ludix Blaster (10" Wheels)	50	2005	2009	R
S	Ludix Acid	50	2006		R
S	Ludix Red Zone	50	2006		R
S	Ludix Urban Track	50	2006	2007	R
S	Ludix 2 Biposto 50cc (2T/10? wheels)	50	2007	2009	F/R
S	Ludix 2 Trend 50cc (2T/12? wheels)	50	2007	2012	R
S	Ludix 2 One Biposoto (2T/10? Wheels)	50	2010	2012	F/R
S	Ludix 2 One Monoposoto (2T/12? Wheels)	50	2010	2011	F/R
S	Ludix Pro (4T / 14" Wheels/AJP Caliper)	50	2011		R
S	Ludix Pro (4T / 14" Wheels/J.Juan Caliper)	50	2011		R
M	METROPOLIS 50	50			F
S	New Vivacity 50cc /2T	50	2008	2012	R
S	New Vivacity 50cc /4T	50	2008	2012	R
S	New Vivacity Sixtes 50cc/4T	50	2010	2012	R
M	SC 50	50			F
M	SPEEDAKE 50	50	1995	2001	R
M	SPEEDFIGHT 50 M (Heng-Tong caliper)	50	1997		R
M	SPEEDFIGHT 50 M (AJP caliper)	50	1997	1998	R
S	Speedfight 3 (50cc A/C - 2T)	50	2009	2012	R
M	SQUAB 50	50	1996	2001	R
M	SQUAB 50 (Heng-Tong caliper)	50	1996	2001	R
M	SV 50 APS SYSTEM	50	1991		F/R
M	SV 50 GEO	50	1992		R
M	SV 50 GEO (all models)	50	1993		R
M	SX 50	50			F
M	TREKKER 50 ROAD	50	1997		R
S	TRK 50 (2T/10? Wheels)	50	2009	2012	R
S	TRK 50 12 (2T/12? Wheels)	50	2009	2012	R

M = MOTORCYCLE
S = SCOOTER
A = ATV
Sn = SNOWMOBILE



RACING
Updated on November 2020

6001



CC FROM TO FRONT / REAR



CC FROM TO FRONT / REAR

Model	CC	FROM	TO	FRONT / REAR	Model	CC	FROM	TO	FRONT / REAR			
FSB704	S	V-Clic 50 (4T)	50	2008	2011	R	M	Splendor NXG	97	2007		R
	M	VIVACITY 50 .	50	1998	2003	R	M	Splendor iSmart	97	2014		F/R
	S	Vivacity 2 50	50	2008	2011	R	M	Splendor Pro Classic	97	2014		F/R
	S	Vivacity 2 50	50	2008	2011	R	M	Splendor	97	2016		F/R
	M	X FIGHT 50 M	50	2000		R	M	Splendor iSmart	97	2016		F/R
	M	ZENITH 50	50	1994	1995	R	M	Splendor Pro	97	2016		F/R
	M	ZENITH 50	50	1996	2000	R	M	Splendor Pro Classic	97	2016		F/R
	M	SC 75	75			F	M	CD 100	100	1985	1991	F/R
	M	SX 75	75			F	M	Dawn	100	2003		F/R
	M	METROPOLIS 80	80			F	M	Passion	100	2000		F/R
	M	SC 80	80			F	M	Splendor	100	1994	2008	R
	M	SV 80 EXECUTIVE	80	1996		R	M	Splendor	100	2008		F/R
	M	SX 80	80			F	M	Pleasure	102	2005		R
	M	ELYSEO 100	100	1998		R	M	Pleasure	102	2014		R
	M	TREKKER 100	100	1998		R	M	Pleasure	102	2016		R
	M	VIVACITY 100 .	100	1998		R	M	iSmart 110	109	2016		R
	M	X FIGHT 100 M	100	2000		R	M	Splendor iSmart 110	109	2016		F/R
	M	LUDIX 125	125	2004		R	M	Splendor Super	124	2005		R
	M	SV 125 GEO	125	1991	1992	R	M	Splendor Super	124	2014		F/R
	M	SV 125 GEO	125	1993		R	M	Splendor Super	124	2016		F/R
PGO	M	STAR 50	50		1993	F	HONDA	MB 50	50	1982		R
	M	STAR 2 50	50	1994		F	M	MBX 50 SD - SF	50	1983		R
	M	BIG MAX 80	80			F	M	MT 50	50	1980		F/R
	M	STAR 80	80	1990		F	M	MTX 50 S	50	1983		F/R
SINNIS	S	Nitro 50 (2T)	50	2009	2010	R	M	MXR 50	50			R
	S	Pioneer 50 (2T)	50	2009	2010	R	M	NSR 50	50	1993	1994	R
	S	QM 50 QT-2T Falcon	50	2008	2010	R	M	NSR 50	50	1994	2000	R
	S	QM 50 QT-6A Jet 50	50	2008	2010	R	M	WW50	50	1995		F
	S	Strike 50 (2T)	50	2009	2010	R	M	WW50DS	50	1995		F
SYM	S	E Woo - Electric		2011		R	M	WW50NS	50	1995		F
	S	E-Symmetry(Electric)		2012	2013	R	M	WW50S	50	1995		F
	S	E-Virid(Electric)		2012		F/R	M	XL 50	50	1977	1988	F/R
	S	E-ViridDeluxe (Electric)		2012		R	M	NSR 75 (Fil)	75	1988		R
	S	Evie (Electric Scooter)		2010		F/R	M	XR 75 K4	75	1975	1979	F/R
	S	Symmetry - Electric		2011		F/R	M	XR 75 K5	75	1979		R
	M	CITY HOPPER 50	50	1999	2002	R	M	CR 80 RA - RB	80	1980	1981	F/R
	M	DD 50 CITY TREK	50	2002		R	M	CR 80 RC	80	1982	1982	F
	M	FIDDLE 50	50	1999		F	M	CR 80 R2F/R2G	80	1985	1986	F
	S	Fiddle II 50	50	2008		R	M	MBX 80 DX	80	1982		R
	S	Fiddle III 50 (4T)	50	2014		R	M	MBX 80	80	1982		R
	M	JET 50	50	1999		R	M	MBX 80 FWD	80	1983		R
	S	Jet Basix 50	50	2006	2009	R	M	MBX 80 VOLLUERKLEIDUNG	80	1985		R
	S	Jet Euro X 50	50	2006	2012	R	M	MCX 80 all models	80	1982	1984	R
	S	Jet 4 (50cc- 4T)	50	2010		R	M	MT 80 all models	80	1980	1984	F/R
	S	Jet 4 R (50cc- 2T)	50	2011		R	M	MTX 80 all models	80	1982	1984	F/R
	S	Jet Evo 50 (2T)	50	2013		R	M	XR 80 A - B - Z	80	1980	1984	F/R
	S	Jet4 Naked (50cc/4T)	50	2013		R	M	XR 80 RJ	80	1989		F/R
	M	JUNGLE 50	50	1999	2002	R	M	C 90	90	1982	2003	F/R
	M	MASK 50	50	2000		R	S	YUPY 90 (NH 90)	90	1990		R
	S	Mio 50	50	2005	2013	R	M	CB 100 N	100	1978		R
	S	Orbit 50	50	2008	2009	R	M	XL 100 all models	100	1978		F/R
	S	Orbit II 50 TS (4T)	50	2012		R	M	CT 110	110	1980	1988	R
	M	RED DEVIL 50	50	1999		R	M	CT 110	110	1989	2004	F/R
	M	SUPER FANCY 50	50	1996	2002	R	M	CT 110	110	2005	2009	F
	M	SUPER FANCY 50 (G5H-6/H325)	50	1996	2002	R	M	CB 125 J	125	1979		R
	S	Symply 50	50	2007	2008	R	M	CLR 125 CITY FLY	125	1998	2003	R
	S	Symply II 50	50	2009		R	M	CR 125 M2 - 3 - 4	125	1976	1978	F/R
	S	Tonic 50	50	2011		R	M	CT 125	125	1976	1978	F/R
	S	XPro 50	50	2013		R	M	MTX 125 RWD	125	1983	1984	F/R
	M	CINDERELLA 50 / 100	100	1999	2000	R	M	MTX 125 R2F	125	1985	1995	R
	M	JET 100	100	1999		R	M	MTX 125 RWF	125	1985	1995	R
	S	Mio 100	100	2005	2014	R	M	MTX 125 RF	125	1985	1995	R
	S	Mio 100	100	2015		R	M	NX 125	125	1988		R
	S	Symba 100	100	2011	2012	F/R	M	NX 125 TRANSCITY	125	1989	1997	R
	S	Mio 115 CBS	115	2017	2018	R	M	TL 125	125	1976		F/R
	S	Orbit III/Symply 125 (4T)	125	2009		R	M	XL 125 K2	125	1976		F/R
	M	SUPER DUKE 125 / 150	125	1999	2000	R	M	XL 125 K3	125	1979		R
YAMAHA	M	50 AXIS	50	1993		R	M	XL 125 S Z-A-B-C	125	1979	1983	F/R
	M	50 AXIS PROFOOT	50	1994		R	M	XL 125 R-C	125	1982	1982	F/R
	M	50 FLY ONE	50	1992	1995	R	M	XL 125 R	125	1985	1986	R
	M	JOG 50 (Italia)	50	1993		R	M	XL 125 S	125	1985	1987	R
	M	50 TRUNK	50	1994		R	M	XL 125 R PARIS DAKAR	125	1986	1986	R
	M	150 FLY ONE	150	1992		R	M	XL 125 R	125	1987	1988	R
FSB705	HERO	HF Dawn	97	2013		F/R	M	XL 125 PARIS DAKAR	125	1989		R
	M	HF Deluxe	97	2013		F/R	M	XL 125 L PARIS DAKAR	125	1989		R
	M	HF Deluxe Eco	97	2016		F/R	M	CRF 150 F	150	2003	2007	R
	M	HF Dawn	97	2016		F/R	M	XL 185 S	185	1979	1981	F/R
	M	Passion Pro	97	2008		F/R	M	CT 200 E - K	200	1984	1989	R
	M	Splendor Plus	97	2003		R	M	CT 200 P	200	1993	1999	F/R
	M	Splendor Pro	97	2005		R	M	CTX 200	200	2003	2004	R



...FSB705

			CC	FROM	TO	FRONT / REAR	
M	MTX 200 RWD	200	1983	1984	F/R		
M	MTX 200 RW	200	1985	1986	R		
M	TL 200 X	200			F/R		
M	TL 200 J	200			F/R		
M	XL 200 R	200	1983	1984	F/R		
M	XR 200 A - RB - RC - RD	200	1981	1983	F/R		
M	XR 200 R	200	1984	1991	F/R		
M	CRF 230 F	230	2003	2007	R		
M	RTL 250 SG	250	1986		F/R		
M	RX 250 RE	250	1984		R		
M	TL 250 KI	250	1979		F/R		
M	TL 250 F	250	1985		F/R		
M	XL 350 R	350	1983	1984	R		
M	XR 350 RE - RD	350	1984		R		
M	XR 500 R	500	1984		R		
M	XR 600 R	600	1985	1987	R		
M	XR 600 R	600	1988	1990	R		
FSB706	HONDA	M	CB 125 K1 - K5	125	1972	1976	R
M	CB 125 K6 - S2	125	1976	1977	R		
M	CB 125 T	125	1978		R		
M	CB 125 T2 - TA - TB	125	1979		R		
M	CB 125 RS	125	1983		R		
M	CB 125 TDC - TDE - TDJ	125	1983	1989	R		
M	CB 125 TT	125	1990		R		
M	CD 125 TC	125	1982		R		
M	CM 125 L	125	1982		R		
M	CD 185 T	185	1978	1980	R		
M	CD 200 T	200	1979	1980	R		
M	CM 200 TA - TB	200	1980	1981	R		
M	CB 250 NIGHT HAWK	250	1991	2001	R		
M	CB 250 TWO FIFTY	250	1993	2005	R		
M	CD 250	250	1988	1992	R		
M	CM 250 C	250	1982		R		
HONDA 3 WHEELERS	A	ATC 70	70	1978	1985	R	
SYM	M	XS 125 K	125	2007		R	
FSB707	HONDA	M	CD 125 TC	125	1982	F	
M	CM 125 L	125	1982		F		
M	CD 185 T	185	1978	1980	F		
M	CD 200 T	200	1979	1980	F		
M	CM 200 TA - TB	200	1980	1981	F		
M	CL 250 SC	250	1981		F		
M	CM 250 C	250	1982		F		
M	XL 250 K3 - K4	250	1978	1979	R		
M	XL 250 S	250	1978	1981	F		
M	XL 250 S	250	1982	1990	F		
M	XR 250 Z - SZ - SA	250	1979	1980	F		
M	XL 500 S	500	1979	1979	F		
FSB708	HONDA	M	CB 250 T	250	1978	1982	R
M	CB 250 N	250	1978	1982	R		
M	CB 250	250	1988	1991	R		
M	CM 250 TB	250	1981		R		
M	CB 350 SG	350	1986		R		
M	CB 400 N/F	400	1983		R		
M	CB 400 A - HAWK	400	1978		R		
M	CB 400 N - NA - NB	400	1978	1982	R		
M	CM 400 AA	400	1978	1981	R		
M	CM 400 AB-TA	400	1978	1981	R		
M	CM 400 A	400	1978	1981	R		
M	CM 400 TZ	400	1978		R		
M	CM 400 T	400	1978	1981	R		
M	CM 400 TC	400	1978	1981	R		
M	CM 400 TB	400	1978		R		
M	CB 450 N	450	1985		R		
M	CBX 450 S	450	1987		R		
M	CMX 450 CG REBEL	450	1986	1988	R		
M	VT 500 CD - FT	500	1982		R		
M	VT 500 ED - EF - C	500	1983		R		
FSB709	HONDA	M	CA 125 REBEL	125	1995	1997	R
M	CA 125 REBEL	125	1998		R		
M	VT 125 SHADOW	125	1999		R		
M	CMX 250 C REBEL	250	1996	2000	R		
M	XL 250 S	250	1982	1990	R		
M	XL 500 S	500	1979	1979	R		
M	XL 500 R	500	1982	1984	R		
M	XL 500 R PARIS DAKAR	500	1982	1984	R		
M	XR 500 SA - SZ	500	1979	1980	R		
M	XR 500 R - RB	500	1981	1983	R		
M	XR 500 R	500	1983	1984	R		
M	XL 600 L - PARIS DAKAR	600	1983	1984	R		
M	XL 600 R	600	1983	1984	R		



FSB710

			CC	FROM	TO	FRONT / REAR	
M	XL 600 LM	600	1985	1990	R		
M	XL 600 RM	600	1986	1990	R		
M	XL 600 V TRANSALP	600	1987	1990	R		
FSB710	HONDA	M	CB 650 A - Z	650	1979	1981	R
M	CB 650 SCC NIGHTHAWK	650	1982		R		
M	CB 650 B	650	1979	1981	R		
M	CB 750 SC NIGHTHAWK	750	1982	1983	R		
M	CB 750 K1 - K6	750	1971	1977	R		
M	CB 750 K7 - K8	750	1978		R		
M	CB 750 KZ	750	1980		R		
FSB711	HONDA	M	CB 500 K1 - K2 - T	500	1975	1977	R
M	CB 500 R/T	500	1994	1996	R		
M	CX 500 CA - CB	500	1979	1981	R		
M	GL 500 SILVER WING INTERSTATE	500	1982		R		
M	GL 500 DC	500	1982		R		
M	NV 600 C	600	1988		R		
M	VLX 600 SHADOW	600	1988	1991	R		
M	VT 600 C SHADOW	600	1988	1993	R		
M	VT 600 C SHADOW	600	1994	2003	R		
M	CB 650 SCD	650	1983		R		
M	CBX 650 ED	650	1983		R		
M	CX 650 ED	650	1982		R		
M	GL 650 D2TE	650	1983		R		
M	GL 650 DD - ID	650	1983		R		
M	VF 700 C MAGNA	700	1984		R		
M	VF 700 S SABRE	700	1984		R		
M	VT 700 C SHADOW	700	1984	1985	R		
M	CB 750 NIGHTHAWK	750	1991		R		
M	VF 750 C-SC-CC-F-FC	750	1983		R		
M	VF 750 CH	750	1987	1989	R		
M	VF 750 C	750	1993		R		
M	VT 750 C SHADOW	750	1983	1985	R		
KYMCO	M	VENOX 250	250	2000		R	
FSB712	HONDA	M	CAMINO 50 all models	50	1980	F/R	
M	PA 50 all models	50	1980		F/R		
M	PF 50 M	50	1975		F/R		
M	PX 50 all models	50	1982	1983	F		
M	PX 50 E	50	1984		F		
KTM	M	50 SX/SXR PRO JUNIOR/SENIOR/ADVENTURE	50	1996	2003	F/R	
M	50 SX SENIOR ADVENTURE	50	2002	2007	R		
M	50 SX PRO SENIOR LC	50	2002	2003	R		
M	50 SX MINI ADVENTURE	50	2004	2007	F/R		
MOTOBECANE	M	all models 50 (mozzi atom)	50	1988	1989	F	
M	all models 50 (mozzi leleu)	50	1988	1989	F		
PEUGEOT	M	103 / 104 / 105 50	50			F/R	
M	ASV 50 (telescopic fork)	50	1993		F/R		
PUCH	M	MAXI 30 30 all models	30			F/R	
M	MAXI 40 40 all models	40			F/R		
M	GTL 50	50			R		
M	MONZA 50 4 SL	50			F/R		
M	MONZA 50 4 GP all models	50			F/R		
M	80 /6	80			R		
FSB714	BS VILLA	M	ZX 50	50	1993		R
DERBI	A	DFW 50	50	2004	2007	F	
HONDA	M	CR 50 R	50	1984	1985	F/R	
M	G-DASH 50	50	1989	1992	R		
M	GP 50 DIO	50	1991	1995	R		
M	LIFE DIO 50	50	1994		F/R		
S	NU 50 M RUNAWAY	50	1982	1983	F		
S	PK 50 WALLAROO DX - STD	50	1990	2001	F		
M	QR 50	50	1993		R		
M	SA 50 J VISION MET-IN	50	1988	1990	F/R		
M	SA 50 VISION	50	1993		F/R		
M	SR 50 DIO	50	1990		R		
M	SR 50 LIFE DIO	50	1994		R		
M	SUPER DIO 50 SR	50	1991	1992	R		
M	SUPER DIO 50 ZX	50	1992		R		
M	TLM 50 F	50	1985		F/R		
M	XR 50 DIO BAJA	50	1994		R		
M	ZX 50 LIFE DIO	50	1994		R		
M	ZX 50	50	1995		R		
M	CR 60 R	60	1986		F/R		
M	CRF 70 F	70	2004		F/R		
M	XR 70 RV	70	1997	2003	F/R		
M	SA 75 VISION	75	1988		R		
S	CH 80 ELITE/SPACY	80	1985	1990	R		
M	CR 80 RC	80	1982	1982	R		
M	CR 80 RD - RE - RF	80	1983	1985	F/R		
M	XR 80 R	80	1985		F/R		
M	CRF 100 F	100	2004		F/R		

M = MOTORCYCLE
 S = SCOOTER
 A = ATV
 Sn = SNOWMOBILE



RACING
 Updated on November 2020

6003



CC FROM TO FRONT / REAR

Code	Brand	Model	CC	FROM	TO	FRONT / REAR	
FSB714	HSC	M XR 100 R	100	1985	2003	F/R	
		M CRF 110 F	110	2013	2018	F/R	
		M CRF 125 F (Small wheel 17"-14")	125	2014	2016	R	
		M CRF 125 FB (Big wheel 19"-16")	125	2014	2018	R	
		M TLR 200 EF	200	1984		F/R	
		M HSC 01 50	50	1992		R	
		M SR 50 DIO	50	1992		R	
		M ZR 50	50	1992		R	
		M ZX 50 DIO	50	1992		R	
		KYMCO	M CX 50	50	1993		R
			M CX 50 SUPER	50	1994	1997	R
			M DJX 50	50	1991	1992	R
			M DJY 50 / DJY 50 REFINED	50	1993		R
M DJW 50	50		1994		R		
M ZX 50 FEVER	50		1995		R		
M ZK 50 SUPERFEVER	50		1999		R		
FSB715	HONDA	M SH 50 CITY EXPRESS	50	1984	1996	R	
		M SH 50 SCOOPY	50	1988	1994	F/R	
		M SH 75 SCOOPY	75	1988	1995	R	
		M SH 80 SCOOPY	80	1984		R	
FSB716	KAWASAKI	M KD 80	80	1988	1990	R	
		M KH 125 A1 -A3	125	1977	1981	R	
		M KX 125 B2 - C1	125	1982	1985	R	
		M KDX 200 A1 - A2	200	1983	1985	R	
		M KDX 200 C1	200	1986	1988	R	
FSB717	KAWASAKI	M KE 175 D1 - D5	175	1979	1983	R	
		M KDX 200 A1 - A2	200	1983	1985	F	
		M KL 250 A3 - A4	250	1980	1984	R	
		M KL 250 C1	250	1980	1984	R	
FSB718	KAWASAKI	M BJ 250 D1-D7 Estrella Custom	250	1996	2002	R	
		M BJ 250 E1-E4A Estrella RS Custom	250	1996	1999	R	
		M BJ 250 F1/F2 (250 TR)	250	2002	2003	R	
		M EL 250 all models	250	1991	1994	R	
		M Z 250 GP BELT DRIVE	250	1983		R	
		M Z 250	250	1983		R	
		M Z 250 B1 - B2	250	1980	1983	R	
		M GPZ 305 A1	305	1983	1996	R	
		M GPZ 305 BELT DRIVE	305	1983	1996	R	
		M GPZ 305 B2 - B3	305	1983	1996	R	
		M Z 400 G1	400	1979		R	
		M ZR 400 A1 - F	400	1983		R	
		M Z 440 A2 - C1	440	1979	1982	R	
		M Z 440 C2	440	1981		R	
		M Z 440 D2 - D4 LTD	440	1979	1982	R	
		M Z 440 D5 LTD	440	1981	1983	R	
		M Z 440 H1 - H2	440	1981	1983	R	
		M ER-5 500 (ER)	500	1997	2000	R	
		M ER-5 500 (ER)	500	2001		R	
		M EX 500 all models	500	1987	1991	R	
		M GPZ 500 S	500	1987		R	
		M GPZ 500 S	500	1988		R	
		M Z 500 F	500	1983		R	
		M ZR 500 A1	500	1983		R	
		M Z 550 F	550	1983	1984	R	
		M ZR 550 A1	550	1983	1984	R	
		M W 650	650	1999		R	
		KAWASAKI ATV	A KLF 185 BAYOU A1 Series	185	1985	2000	R
			A KLF 185 BAYOU A2 / A3 / A4	185	1986	1988	R
			A KLF 220 BAYOU A Series	220	1988	2002	R
			A KLF 250 BAYOU A Series	250	2003	2010	R
			A KLF 300 BAYOU A Series	300	1986	1987	R
			A KLF 300 BAYOU B Series	300	1988	2004	R
FSB719	KAWASAKI	M VN 400 VULCAN	400	1995		R	
		M VN 400 CLASSIC	400	1999		R	
		M Z 400 J1 LTD	400	1980	1981	R	
		M Z 400 J2 - J3	400	1981	1983	R	
		M ZL 400	400	1986	1987	R	
		M LTD450 (EN450 A1-A5)	454	1986	1989	R	
		M EN 500 all models	500	1990	1993	R	
		M A1 550 LTD	550	1980		R	
		M Z 550 A3 - C1 - C2 LTD	550	1980		R	
		M Z 550 A1	550	1980		R	
		M Z 550 GT - SPORT	550	1983		R	
		M Z 550 G1 SHAFT	550	1983		R	
		M ZL 600 A1/A2	600	1985	1994	R	
		M ZL 600 B1 ELIMINATOR	600	1995	1997	R	
		M Z 650 B1 - B3	650	1979	1981	R	
		M Z 650 F1	650	1979	1980	R	
		M Z 650 F2 - F4	650	1980	1983	R	



CC FROM TO FRONT / REAR

Code	Brand	Model	CC	FROM	TO	FRONT / REAR	
FSB721	BAJAJ	M VN 750 TWIN	750	1986	1987	R	
		M VN 750 VULCAN	750	1990	1994	R	
		M 750 VULCAN	750	1989	1993	R	
		M Z 750 LTD TWIN K1	750	1983		R	
		M Z 750 Y1 LTD	750	1982		R	
		M EJ800 (W 800 all model)	800	2011		R	
		M VN 800	800	1995	1998	R	
		M VN 800 CLASSIC	800	1996		R	
		M VN 850	850	1995	1999	R	
		M Discover 100 ES (4G)	94	2010		F/R	
		M Discover 100	94	2011		F/R	
		M Discover 100 M	102	2013		F/R	
		M Discover 100 T	102	2013		F/R	
		M Discover 112	111	2004		F/R	
		M Discover 125 ST	124	2012		R	
M Discover 125 T	124	2013		R			
M Discover 125 M	124	2014		R			
M Discover 125	125	2005		R			
M Discover 125	125	2016		R			
M XCD 125 DTS-Si	125	2008		F/R			
M Discover 135	134	2008		R			
M Discover 135 DTS-i	134	2010		R			
M Pulsar 135 DTSi	134	2010		R			
M Pulsar 135 LS	134	2011		R			
M Discover 135	135	2004		R			
M Pulsar 150 Classic	143	2001		R			
M Discover 150	144	2010		R			
M Discover 150 F	144	2016		R			
M Discover 150 S	144	2016		R			
M Pulsar 150 DTSi UG1	149	2003		R			
M Pulsar 150 DTSi UG2	149	2005		R			
M Pulsar 150 DTSi UG3	149	2006		R			
M Pulsar 150 DTSi UG4	149	2006		R			
M Pulsar 150	149	2011		R			
M Pulsar 150	150	2001		R			
M Pulsar 150 AS	150	2011		R			
M Eliminator	174	2001		R			
M Pulsar 180 Classic	178	2001		R			
M Pulsar 180 DTSi UG1	178	2003		R			
M Pulsar 180 DTSi UG2	178	2005		R			
M Pulsar 180 DTSi UG3	178	2006		R			
M Pulsar 180 DTSi UG4	178	2009		R			
M Pulsar 180	178	2011		R			
M Avenger 180	180	2005	2007	R			
M Eliminator 180	180	2001		R			
M Pulsar 180	180	2001		R			
M Pulsar 200 DTSi	198	2007		R			
M Pulsar 200 AS	199	2011		R			
CFMOTO	HYOSUNG	M CF 150 Leader	150	2010	2012	R	
		M RX 125	125	2001	2007	R	
		KAWASAKI	M KH 100 A2 - A4	100	1978	1981	F
			M KM 100 A4 - A6	100	1978	1981	F
			M AR 125 A1 - LC	125	1982	1994	R
			M BN 125 A1/A2 ELIMINATOR	125	1998	1999	R
			M BN 125 A3/A4 ELIMINATOR	125	2000		R
			M KE 125 A4 - A10	125	1976	1985	R
			M KH 125 EX	125	1982	1983	R
			M KH 125 K1	125	1982	1998	R
			M KH 125 K2-4 - L1	125	1982	1983	R
			M KX 125 A3 - A7	125	1974	1980	R
			M KX 125 B1	125	1981	1981	R
			M KDX 175 all models	175	1980	1982	R
			M Z 200 A1 - A5	200	1977	1982	R
M Z 200 A6	200		1983		R		
M KLX 250	250		1979	1980	R		
M KX 250 B2 - B3	250	1980	1981	R			
M KX 250 B1	250	1982	1982	R			
M KX 250 C1 - C2	250	1983	1985	R			
M Z 250 LTD	250	1983		R			
M Z 250 C1 - C2	250	1981	1983	R			
M Z 250 G1 - G2	250	1981	1983	R			
M KX 500 A1 - A2	500	1983	1985	R			
KAWASAKI 3 WHEELERS	KAWASAKI ATV	S KLR 570	570	1988		R	
		M KLR 600	600	1984	1988	R	
		M KLR 600 ELECTRIC STARTER	600	1985		R	
		M KLR 600 S	600	1992		R	
		A KLT 110 A1 / A2 / A3	110	1984	1986	R	
		A KLT 160 A1	160	1985	2000	R	
		A KLT 185 A1 / A2	185	1986	1987	R	
		A KLF 110 MOJAVE A / B	110	1987	1988	R	

FRONT
/ REAR

CC	FROM	TO	FRONT / REAR				
FSB721	PGO	S	Bubu 100	100	2003	2008	R
		S	My Bubu 100	100	2003	2005	R
		S	Bubu 125	125	2003	2008	R
		M	I-CHARGE 125	125	2003	2004	R
		M	MY BUBU 100 / 125	125	2003	2004	R
		M	T-REX 125	125	1999	2004	R
		S	T/Rex 125	125	1999	2007	R
		M	YOUNG BUBU 125	125	2003	2004	R
		M	T-REX 150	150	1999	2004	R
	SINNIS	M	QM 125 GY Apache 125 (Rear drum model)	125	2009	2010	R
		M	QM 125 GY-2D Trackstar 125 (4T)	125	2010		R
	SUZUKI	M	RG 80 GAMMA	80		1987	R
		M	RG 80 GAMMA	80	1988	1993	R
		M	RM 80 X - D - E	80		1985	F
		M	TS 90	90	1971	1973	R
		M	GP 100 UD - UN - UX	100	1979	1992	F
		M	RM 100 A - B - C	100	1976	1978	R
		M	TS 100 K - L - M	100	1973	1975	R
		M	TS 100 ERN - ERT - ERX	100	1975	1981	F/R
		M	TS 100 A - B - C	100	1975	1981	F/R
		M	TS 100 ERZ	100	1982	1987	F
		M	DR 125 SD - SZ	125	1982	1984	F/R
		M	DR 125 S	125	1986	1993	R
		M	DR-Z 125	125	2003		F/R
		M	DR-Z 125	125	2003		R
		M	ER 125	125			F/R
		M	GN 125	125	1983	1993	R
		M	GN 125 R	125	1994	2001	R
		M	GP 125 X - XD	125	1977	1984	R
		M	GS 125 D	125	1982	1984	F/R
		M	GS 125 Z	125	1982	1984	F/R
		M	GS 125 ESZ	125	1982		R
		M	GS 125 ESD	125	1983	1994	R
		M	GS 125 E - KATANA	125	1990	1994	R
		M	GS 125 ESR / ESX	125	1995	2000	R
		M	GT 125 N - EN	125	1974		R
		M	GZ 125 MARAUDER	125	1998	2011	R
		M	RG 125 E	125	1982	1984	R
		M	RG 125 W GAMMA	125	1985	1991	R
		M	RM 125 A - B - C - M	125	1975	1978	F/R
		M	RM 125 N - T	125	1979	1980	F
		M	RM 125 N	125	1979	1980	F
		M	RM 125 D - X - Z	125	1981	1983	F
		M	RM 125 X - Z	125	1981	1983	F
		M	RV 125 K	125	1973		R
		M	RV 125 A - L - M	125	1974	1976	F/R
		M	T 125 STINGER	125	1970	1971	F/R
		M	TS 125 K	125	1972	1972	R
		M	TS 125 A - B - C - C2	125	1973	1981	F/R
		M	TS 125 L	125	1973	1981	F/R
		M	TS 125 ERN - ERT - ERX	125	1973	1981	F/R
		M	TS 125 M - N	125	1973	1984	F/R
		M	TS 125 ERZ - FFS	125	1982	1983	F
		M	TS 125 L - LC - XE	125	1984	1987	F
		M	VL 125 INTRUDER	125	2000		R
		M	X4 125	125			R
		M	PE 175 C - CE2 - N	175	1978	1979	F/R
		M	PE 175 T - X	175	1980	1981	F
		M	GT 185 EC - L - M	185	1974	1979	R
		M	GT 185 A - B - C	185	1974	1979	R
		M	TS 185 B - C	185	1974	1981	F/R
		M	TS 185 ERN - ERT - ERX	185	1974	1981	F/R
		M	TS 185 K	185	1973	1973	R
		M	TS 185 L - M	185	1974	1981	F/R
		M	DR 200 K	200	1989	1998	R
		M	GT 200 EN - EX	200	1979	1982	R
		M	GT 200 X 5	200	1979	1982	R
		M	SB 200 N - X	200	1979	1981	R
		M	DR 250	250	1981	1982	F/R
		M	DR 250 S	250	1983	1984	R
		M	DR 250 S	250	1985		R
		M	DR 250 S	250	1986	1989	R
		M	GN 250	250	1993	1997	R
		M	GZ 250 MARAUDER	250	2000		R
		M	RM 250 A - B - C	250	1976	1978	F
		M	TU 250 X	250	1997	2000	R
		M	VL 250 INTRUDER	250	2000	2001	R
		M	RM 400 C	400	1978	1978	F
		M	DR 500 S	500	1989		R
		M	RM 500 D - E	500	1983	1984	R

FRONT
/ REAR

CC	FROM	TO	FRONT / REAR				
		M	RM 500 F	500	1985	1986	R
		M	DR 600 S - SU	600	1987	1986	R
		M	DR 600 R DAKAR-DJEBEL	600	1987	1988	R
		M	DR 600 S	600	1989		R
		M	SP 600	600	1985		R
FSB722	HYOSUNG	M	KR 110 MASTER	110	2004		R
	KAWASAKI	M	AE 50 - A1 - A2	50	1981	1982	F/R
		M	AR 50	50	1981	1995	R
		M	KMX 50	50	1988		R
		M	AE 80 A1 - B1	80	1981	1982	F/R
		M	AR 80	80	1981	1982	R
		M	KC 100 C1/2/3/4	100	1980	1983	F/R
		M	KE 100 all models	100	1979	1991	F/R
		M	KH 100 A2 - A4	100	1978	1981	R
		M	KH 100 G2 - G3	100	1981	1982	R
		M	KH 100 G4	100	1983		R
		M	KM 100 A4 - A6	100	1978	1981	R
		M	KLX 110 R	110	2002		R
		M	KAZER 115 R	115	1998	1999	R
	KAWASAKI 3 WHEELERS	A	KLT 110 A1 / A2 / A3	110	1984	1986	F
		A	KLT 160 A1	160	1985	2000	F
		A	KLT 185 A1 / A2	185	1986	1987	F
		A	KLT 200 All Models	200	1981	1984	F
		A	KLT 250 All Models	250	1982	2000	F
	KAWASAKI ATV	A	KLF 110 MOJAVE A / B	110	1987	1988	F
	MODENAS	M	KRISS 115	115		1998	F/R
		M	KRISS 115	115	1999		R
	SUZUKI	M	AP 50	50	1971	1978	F/R
		M	AP 50	50	1995	2002	R
		M	F 50	50	1971	1973	F/R
		M	FR 50	50	1971	1981	F/R
		M	GT 50	50	1977	1980	R
		M	RM 50 C - N - T	50	1978	1980	F/R
		M	TS 50 D all models	50	1979		F/R
		M	ZR 50 KEN - KEX	50	1979		R
		M	FR 70	70	1974		F/R
		M	3 E 80	80			R
		M	FR 80 all models	80	1976	1983	F/R
		M	GT 80 L	80	1981		R
		M	RM 80 N - B - C	80	1977	1979	F/R
		M	TS 90	90	1971	1973	F
		M	A 100 all models	100	1974	1980	F/R
		M	GP 100 C - DEN - N - X	100	1978	1987	R
		M	GP 100 UD - UN - UX	100	1979	1992	R
		M	RM 100 A - B - C	100	1976	1978	F
		M	RM 100 N-T-X	100	1979	1981	F
		M	TS 100 K - L - M	100	1973	1975	F
		M	CS 125 D	125	1983		F/R
		M	RV 125 K	125	1973		F
		M	RV 125 K2/ K3 / K4 VAN VAN	125	2002		R
		M	TS 125 K	125	1972	1972	F
		M	VAN VAN 125 (RV)	125	2010		R
		M	TS 185 K	185	1973	1973	F
		M	VAN VAN 200	200	2016		R
		M	PE 250 N	250	1979	1979	F/R
		M	PE 250 X - Z	250	1981	1982	F
		M	PE 400 T	400	1979	1981	F
		M	PE 400 X	400	1979	1981	F
	TVS	M	AX100	100	1992	2004	F/R
FSB723	KAWASAKI	M	KLX 125 A	125	2003	2006	F/R
		M	KLX 125 L	125	2003	2006	R
	KAWASAKI ATV	A	KSF 50 / KFX 50	50	2003	2007	R
	SUZUKI	M	OR 50	50	1980		R
		M	RM 50 X - Z 50	50	1981	1982	F/R
		M	TS 50 XKE-XKG all models	50	1984	2000	R
		M	ZR 50 SKX - SLKX	50	1981	1987	R
		M	DS 80	80	1993	2000	F/R
		M	RM 80 X - D - E	80		1985	R
		M	RM 80 XT - XX	80	1980	1981	F/R
		M	TS 100 ERZ	100	1982	1987	R
		M	TS 125 ERZ - FFS	125	1982	1983	R
	SUZUKI ATV	A	LT-A 50 QUADSPORT	50	2002	2005	R
		A	LT-Z 50 QUADSPORT	50	2006		R
		A	LT-Z 90 QUADSPORT	90	2006		F
FSB724	KAWASAKI	M	KDX 250 B1	250	1979		R
		M	KL 250 A1 - A2	250	1978	1979	R
		M	KX 250 A all models	250	1974	1979	R
		M	KX 420 A1 - A2	420	1980		R
	SUZUKI	M	ADDRESS 125	125	2008		R
		M	SB 200 N - X	200	1979	1981	F

M = MOTORCYCLE
S = SCOOTER
A = ATV
Sn = SNOWMOBILE**FERODO**

RACING

Updated on November 2020

6005



CC FROM TO FRONT / REAR

Code	Brand	Model	CC	FROM	TO	FRONT / REAR			
FSB724		M PE 250 B - C	250	1977	1978	F/R			
		M PE 250 T	250	1980	1980	F/R			
		M PE 250 X - Z	250	1981	1982	R			
		M RM 250 A - B - C	250	1976	1978	R			
		M RM 250 N	250	1979		F			
		M TS 250 all models	250	1974	1982	F/R			
		M TS 250 X all models 250	250	1986	1989	R			
		M SP 370 C - N	370	1977		F/R			
		M DR 400 ST - SX	400	1979	1981	F/R			
		M LS 400 SAVAGE	400	1987		F/R			
		M PE 400 T	400	1979	1981	R			
		M PE 400 X	400	1979	1981	R			
		M RM 400 C	400	1978	1978	R			
		M RM 400 N	400	1979	1979	F			
		M SP 400	400	1979		F/R			
		M ST 400	400	1979		F/R			
		M SX 400	400	1979		F/R			
		M DR 500 SD - SE	500	1983		F/R			
		SUZUKI 3 WHEELERS	A ALT 125 E/F/G	125	1984	1986	R		
			A ALT 185 F	185	1985	1987	R		
		SUZUKI ATV	A LT 125 E	125	1984	2000	R		
			A LT 160 (All models)	160	1989	2004	R		
			A LT 185 E/F/G/H	185	1984	1987	R		
			A LT 230 GEF/GEG QUADRUNNER	230	1985	1986	R		
			A LT-F 230 G/H	230	1986	1987	R		
		FSB725	SUZUKI	M GN 250 F / J	250	1983	1997	R	
				M GNX 250 E	250	1983		R	
				M GS 250 E	250	1979	1981	R	
				M GS 250 T - TT - TX	250	1979	1981	R	
				M GSX 250 E - ET - EX - EZ - T	250	1979		R	
				M GSX 250 S	250	1985	1990	R	
				M GT 250 EN - ET - EX	250	1978		R	
M GT 250 X7	250			1978		R			
M GN 400 TT	400			1980		R			
M GSX 400 L	400			1980	1983	R			
M GSX 400 ET - EX - EZ	400			1980	1983	R			
M GSX 400 TWIN	400			1980	1983	R			
M GS 425 EN	425			1978	1980	R			
M GS 450 ET - L - T	450			1980	1980	R			
M GR 650 - X	650			1983		R			
M LS 650 SAVAGE	650			1987	1999	R			
M LS 650 P	650			1993		R			
SUZUKI ATV	A LT-A 400 F KING QUAD 4X4			400	2008	2011	R		
	A LT-A/F 400 EIGER (All models)			400	2002	2008	R		
	A LT-F 400 KING QUAD FS 4X4			400	2008	2012	R		
	A LT-F 400 KING QUAD 4X2			400	2008	2010	R		
FSB726	SUZUKI			M CL 50 D LOVE	50	1983		R	
				M CL 50 D SUZY	50	1983		R	
				M CS 50 D	50	1983	1984	F/R	
				M CS 50 Z ROADIE	50	1983	1984	F/R	
				SUZUKI 3 WHEELERS	A ALT 50 D/E	50	1983	1984	R
					SUZUKI ATV	A LT 50	50	1984	1987
		FSB727	E-TON ATV KAWASAKI ATV SUZUKI SUZUKI ATV	A DXL-90 Sierra		90	1999	2003	F
				A KSF 50 / KFX 50	50	2003	2007	F	
				A KSF 80 / KFX 80	80	2003	2006	F	
				A KSF 90 / KFX 90	90	2006	2007	F	
M CARNA 50	50			1990		F			
M CL 50 D LOVE	50			1983		F			
M CL 50 D SUZY	50			1983		F			
M F 50 SUZY	50					F/R			
M FS 50 T - X SNIP	50			1981	1982	F/R			
A LT-A 50 QUADSPORT	50			2002	2005	F			
A LT-Z 50 QUADSPORT	50	2006		F					
A LT 80 all models	80	1987	2007	F					
FSB728	SUZUKI	M RG 50 GAG - GAMMA	50	1987		R			
		M S 50 K	50	1993		F			
		M RM 100 N-T-X	100	1979	1981	R			
		M RM 125 N - T	125	1979	1980	R			
		M TS 125 X	125	1988		R			
		M TS 240 X	240	1988	1990	R			
FSB729	SUZUKI	M TS 50 XKE-XKG all models	50	1984	2000	F			
		M TS 80 X	80	1984		F			
		M RM 125 N	125	1979	1980	R			
		M TS 125 L - LC - XE	125	1984	1987	R			
		M TX 125 XF	125	1985		R			
FSB730	MBK YAMAHA	M CHAMP 50	50			F/R			
		M CA 50 SALIENT	50	1983	1986	F			
		M MA 50 M	50	1981		F/R			
		M MINT 50	50	1996		F			
		M MJ 50 M TOWNY	50	1981	1993	F/R			



CC FROM TO FRONT / REAR

Code	Brand	Model	CC	FROM	TO	FRONT / REAR
FSB731	ADLY	M MS 50	50	1985	1986	F
		M PW 50	50	1980	2013	F/R
		M QA 50 POCHE	50	1983		F/R
		M QB 50 VOGEL	50	1983		F/R
		M QT 50	50	1980		F/R
		M SA 50 M - ME PASSOLA	50	1980	1984	F
		M SH 50 RAZZ	50	1993		F
		S Cat 50	50	1998		R
		S Fox 50 / SILVER FOX 50	50	2000		R
		S G-Shock 50	50	1998		R
		S Jet 50	50	1996		R
		S Pista 50	50	1996		R
		S Predator 50	50	2000		R
S Super Sonic 50	50	2000		R		
S Thunderbike 50	50	1997		R		
S Cat 100	100	1998		R		
S G-Shock 100	100	1998		R		
S Jet 100	100	1996		R		
S Predator 100	100	2000		R		
S Cat 125	125	1998		R		
BENELLI	S QuattroNove X (50cc/All Rear Drum Models)	50	2008	2012	R	
	BRANDY-BRAS	M BRANDY 50	50			R
M BRANDY 90		90			R	
CPI	M HUSSAR 50	50	2001	2002	R	
	M OLIVER 50	50	2003	2005	R	
FANTIC	M HUSSAR 50 / 125 / 150	125	2003		R	
	M PONY 50	50	1993		F/R	
ITALJET	M PONY 50 SR	50	1993		R	
	M QUEENIE 50	50	1995		R	
KEEWAY	M ADLY 50	50	1990	1995	R	
	S Agora 50 (2T/4T)	50	2010		R	
KOTIR	S ARN 50 (25/45)	50	2010	2011	R	
	S EasyHurricane 50 (25/45)	50	2007	2012	R	
	S F-Act 50	50	2007	2010	R	
	S F-Act-NKD 50	50	2009	2011	R	
	S F-Act 50 EVO (4T)	50	2009		R	
	S F-Act- 50 Racing (25/45)	50	2010	2012	R	
	S F-Act- 50 RS	50	2010	2011	R	
	S Flash 50	50	2007	2009	R	
	S Flash 50 Electric	50	2009	2010	R	
	S Focus 50	50	2006	2007	R	
	S Goccia 50 (2T/4T)	50	2008		R	
	S Hacker 50	50	2008	2009	R	
	S Hurricane 50	50	2007		R	
	S Hurricane 50-Base	50	2007		R	
	S Matrix 50 (2T)	50	2006	2012	R	
	S Matrix V4 50 (25/45)	50	2010	2011	R	
	S Pixel 50	50	2008	2012	R	
	S RY6 50cc (25/45)	50	2010		R	
	S RY8 50cc (All models)	50	2007	2009	R	
	S RY8 SP 50cc (25/45)	50	2010	2011	R	
S Swan 50 (25/45)	50	2010	2011	R		
S 50 Zahara (2T/4T)	50	2013		R		
S ARN 125	125	2006	2012	R		
S F-Act 125	125	2007	2011	R		
S 125 Zahara (2T/4T)	125	2013		R		
KSR MOTO BY GENERIC	M RS 50	50	1990		F/R	
	S Epico Electric		2012	2013	R	
	S Cracker 50 (2T/4T)	50	2009		R	
	S Epico 50 (2T)	50	2010		R	
	S Jump 50 (2T)	50	2012		R	
	S Onyx 50 (2T/All Models)	50	2010	2012	R	
	S Race 2 50 (2T/4T)	50	2010		R	
	S 50 GT Race Explorer	50	2009	2009	R	
	S Roc 50	50	2008	2011	R	
	S Sirion 50 (2T/4T)	50	2012		R	
S Sirion 50 Sport (2T)	50	2012	2012	R		
S Vendetta 50 (2T)	50	2012		R		
S Race 2 125 (4T)	125	2010		R		
S Sirion 125 (4T)	125	2012		R		
S Vertigo 125	125	2013		R		
LEM	M FLASH 50	50	1994		R	
	M GHIBLI 50	50	1990		F/R	
MBK	M BOOSTER 50 NEXT GENERATION	50	1996	1998	R	
	M EVOLIS 50	50	1992		R	
	M OVETTO 50	50	1997		R	
	M ROCKET 50	50	1996	1998	R	
	M SORRISO 50	50	1992	1996	F/R	
	M STUNT 50	50	2000		R	
M TARGET 50	50	1992		R		



CC FROM TO FRONT / REAR

CC	FROM	TO	FRONT / REAR
FSB731	M	X-LIMIT 50	50 1998 2003 R
	M	EVOLIS 80	80 1994 R
	M	XC 125 FLAME	125 1998 R
	M	XC 125 FLAME R	125 1998 R
PEUGEOT	S	Sum-Up (125cc)	125 2008 2011 R
	S	Tweet 125 Evo (4T/Rear Drum Model) (LW2)	125 2010 R
	S	Vivacity 125 (4T)	125 2010 2012 R
	S	Vivacity Sixties 125 (4T)	125 2011 2012 R
	S	Tweet 150 (4T/Rear Drum Model)	150 2010 2011 R
PGO	M	MY BUBU 50	50 2003 R
POLARIS ATV	A	SCRAMBLER (3 wheeler)	1985 1986 F
	A	TRAIL BOSS 2x4	1985 1987 F
	A	CYCLONE 250 X	250 1987 2000 F
RAPIDO	M	SCRENNA 50	50 R
YAMAHA	S	BW's NAKED 50	50 2003 2004 R
	S	BW'S 50	50 2004 2004 R
	M	CR 50 TARGET	50 1991 R
	M	CR 50 Z	50 1992 R
	S	CS 50 Jog R	50 2002 2005 R
	S	CS 50 Z (Jog RR)	50 2003 2005 R
	M	CT 50 SUPER SPORT	50 1990 F/R
	M	DT 50 LCD	50 1996 1998 R
	M	DT 50 R	50 1997 R
	M	EW 50 SLIDER	50 2000 2003 R
	M	50 SPY	50 1996 1998 R
	M	YE 50 ZEST	50 1992 R
	M	YH 50 WHY	50 1999 R
	S	YN 50 R NEO'S	50 1997 2002 R
	S	YN 50 NEO'S	50 2002 2006 R
	M	YSR 50	50 1986 1987 R
	M	YSR 60	60 1986 1987 R
	M	80 BELUGA	80 1989 F/R
	M	TY 80	80 1983 R
	M	YSR 80	80 1986 R
	M	CR 90 TARGET	90 1991 R
	M	TT-R 90	90 2000 2004 R
	M	RT 100	100 1994 2003 F/R
	M	YB 100	100 1982 1986 R
	M	YB 100	100 1987 1992 F/R
	M	YZ 100 J - K	100 1982 1983 F
	M	TT-R 110	110 2008 R
	M	SR 125 SE	125 1982 1992 R
	M	SR 125	125 1997 2003 R
	M	TT-R 125 LW	125 2000 2012 R
	M	TT-R 125	125 2000 F/R
	M	TW 125	125 1998 2002 R
	M	XC 125 CYGNUS T	125 1995 R
	M	XC 125 CYGNUS	125 1996 1997 R
	M	TW 200	200 1989 1992 R
	M	TW 200	200 1993 2000 R
	M	TW 200	200 2001 2003 R
	M	SEROW 225 XT	225 1985 1992 R
	M	TT-R 225	225 1999 2002 R
YAMAHA 3 WHEELERS	A	YT 175 J/K	175 1982 1983 F
	A	YTM 200 K/L/N	200 1983 1985 F
	A	YTM 200 EK/EL	200 1983 1984 F
	A	YTM 200 ERN	200 1985 2000 F
	A	YTM 225 DXK/DXL/DXN	225 1983 1985 F
	A	YTM 225 DRN/DRS	225 1985 1986 F
YAMAHA ATV	A	YFM 50 RAPTOR	50 2004 2007 F
	A	YFM 80 BADGER	80 1992 2001 F
	A	YFM 80 RAPTOR	80 2002 2008 F
	A	YFM 80 GRIZZLY	80 2005 2008 F
	A	YFM 100 W/A/B CHAMP	100 1989 1991 F
	A	YFA1 125 BREEZE	125 1989 1991 F
	A	YFA1 125 BREEZE	125 1992 2004 F
	A	YFM 125 GRIZZLY	125 2004 2010 F
	A	YFM 200 (Moto 4)	200 1985 1989 F
	A	YFS 200 BLASTER	200 1988 2002 F
	A	YFM 225 (Moto 4)	225 1986 1988 F
	A	YFB 250 D/E/F TIMBERWOLF	250 1992 1994 F
FSB732	M	POPCORN 50	50 2003 R
GARELLI	M	GRINTA	50 1995 R
	M	PONY 50	50 1992 F/R
	M	PONY 50 SR	50 1992 1995 R
	M	QUEENIE	50 1995 R
HONDA	S	CN 250 HELIX-FUSION	250 1986 1987 R
YAMAHA	M	50 CHAPPY	50 1980 F/R
	M	DT 50 M - MX	50 1978 1987 F/R
	M	FS 1 50 E	50 1974 1975 F/R



CC FROM TO FRONT / REAR

CC	FROM	TO	FRONT / REAR	
	M	FS 1 50 E DX	50 1976 1979 R	
	M	FS 1 50 SE	50 1981 1982 F/R	
	M	LB 2 50 M CHAPPY	50 1980 F/R	
	M	LC 50 M	50 1980 F/R	
	M	RD 50 M	50 1978 R	
	M	RD 50 MX	50 1981 1987 R	
	M	TY 50 M	50 1979 F/R	
	M	V 50 M - P	50 1974 1982 F/R	
	M	V 70 A	70 1976 F/R	
	M	BOP 80 2	80 1980 F/R	
	M	DT 80 MX - MX-S	80 1981 F/R	
	M	DT 80 LC	80 1981 F/R	
	M	DT 80 LC - LC II - N	80 1985 R	
	M	FS 80 SE	80 1981 1982 F/R	
	M	RD 80 MX	80 1981 1982 R	
	M	RD 80 AIR COOLED	80 1981 1982 R	
	M	RD 80 LC2 - LCS	80 1982 R	
	M	RX 80 SE	80 1982 R	
	M	TY 80	80 1977 R	
	M	V 80	80 1979 1982 F/R	
	M	YZ 80	80 1977 1979 R	
	M	V 90	90 1978 F/R	
	M	DT 100	100 1976 1980 F	
	M	RS 100	100 1975 1977 F/R	
	M	RS 100 all models	100 1977 1980 R	
	M	YB 100	100 1978 1981 F/R	
	M	YB 100	100 1982 1986 F	
	M	YZ 100 E - F - G - H	100 1978 1981 F	
	M	IT 125 G - H - J	125 1980 1982 F	
	M	TY 125	125 1982 F	
	M	TY 175	175 1977 1980 F	
	M	TW 200 T/U/W	200 1987 1988 R	
	M	TY 250 D - E - F - G	250 1977 1980 F	
	M	TY 250 R	250 1991 1993 R	
	M	TY 250 S - RS	250 1984 1990 R	
FSB733	APRILIA	S	SCARABEO 100 (Minarelli engine)	100 2000 R
	KEEWAY	S	110 Kee	110 2012 R
		S	110 Target	110 2013 R
		S	Focus 125	125 2006 2007 R
		S	Matrix 125	125 2006 2007 R
		S	Matrix 125	125 2007 2010 R
		M	125 New Strike	125 2013 F/R
		S	RKS 125	125 2012 R
		M	125 Strike	125 2013 R
		S	125 Target	125 2013 R
		S	Am 150	150 2006 2009 R
		S	F-Act 150	150 2007 2010 R
		S	Matrix 150	150 2007 2010 R
		M	150 New Strike	150 2013 F/R
		M	RKS 150	150 2012 R
		M	150 Strike	150 2013 R
		S	200 New Strike	200 2013 F/R
		M	RKS 200	200 2012 R
	MBK	M	NITRO 100	100 2000 2003 R
		M	OVETTO 100	100 2000 2002 R
	SACHS	M	ROADSTER 125	125 2000 2003 R
	SINNIS	M	Pioneer 125	125 2009 2010 R
		M	QM 125-2 V Max 125	125 2008 2010 R
		S	QM 125 T- Matrix	125 2010 R
		S	QM 125 T-10H Matrix II	125 2010 R
		S	QM 125 T-10R Eagle 125	125 2010 R
		S	Sublime 125	125 2009 2010 R
		S	WY 125 T-56A Nitro 125	125 2009 2010 R
	SYM	S	CombBiz 125	125 2011 R
	YAMAHA	M	DT 80 LC2	80 1993 R
		M	RD 80 LC1	80 1982 R
		M	TRZ 80	80 1991 R
		M	DT 100	100 1976 1980 R
		M	YQ 100 AEROX	100 2000 2002 R
		M	YZ 100 E - F - G - H	100 1978 1981 R
		M	YZ 100 J - K	100 1982 1983 R
		M	125 ACTIVE	125 1990 F/R
		M	BL 125 BELUGA	125 1985 1987 F/R
		M	BL 125 BELUGA	125 1988 1992 R
		M	DT 125 E - LC - MX	125 1974 1984 F/R
		M	DT 125 LC - R	125 1985 1986 R
		M	DT 125 (Italia)	125 1986 1987 R
		M	DT 125 TENERE (Italia)	125 1987 R
		M	DT 125 CHESTERFIELD SCOUT	125 1988 R
		M	DT 125 LC TENERE	125 1988 R

M = MOTORCYCLE
S = SCOOTER
A = ATV
Sn = SNOWMOBILE



CC FROM TO FRONT / REAR

CC	FROM	TO	FRONT / REAR
...FSB733	M	DT 125 CHESTERFIELD SCOUT	125 1989 R
	M	DT 125 MX (drum brakes)	125 1992 F/R
	M	IT 125 G - H - J	125 1980 1982 R
	M	RD 125 DX	125 1975 1977 R
	M	RD 125 LC	125 1982 1984 R
	M	RD 125 LC R	125 1985 1987 R
	M	RS 125	125 1975 R
	M	RS 125 DX	125 1976 1980 R
	M	SR 125 SE	125 1982 1992 F
	M	TY 125	125 1982 R
	M	TZR 125	125 1987 1989 R
	M	XC 125 BELUGA	125 1993 R
	M	YZ 125 C - D - E - F - G - H - J	125 1976 1982 R
	M	CRYPTON T135	135 2006 R
	M	DT 175 MX	175 1974 1983 F/R
	M	IT 175 G - H - I	175 1980 1982 R
	M	TY 175	175 1977 1980 R
	M	RT 180	180 1990 1992 R
	M	XC 180 GYGNUM	180 1983 1985 F
	M	TW 200	200 1989 1992 F
	M	XV 240 VIRAGO	240 1991 1992 R
	M	SR 250	250 1987 R
	M	SR 250 E (Espana)	250 1990 1994 R
	M	SR 250 SE	250 1980 1982 R
	M	TT 250 S	250 1987 1992 R
	M	TY 250 D - E - F - G	250 1977 1980 R
	M	XL 250 G	250 1980 R
	M	XT 250	250 1980 F/R
	M	XV 250 VIRAGO	250 1993 1994 R
	M	YZ 250 G	250 1980 R
	M	YZ 250 J - K - L	250 1982 1984 R
	M	YZ 250	250 1985 1987 R
	M	TT 350	350 1986 1990 R
	M	XT 350 4 VALVES	350 1986 1987 R
	M	XT 350	350 1988 1990 R
	M	XT 350	350 1991 R
	M	XT 350	350 1992 1995 R
	M	IT 490 L	490 1983 1984 R
	M	YZ 490 K - L	490 1983 1984 R
	M	TT 600	600 1987 1992 R
	M	TT 600 L	600 1983 1984 R
	M	TT 600 N	600 1985 2000 R
	M	XT 600 4 VALVES	600 1986 1986 R
	M	XT 600 Z TENERE	600 1985 1987 R
	A	YAMAHA ATV YFM 80 N/S (MOTO4)	80 1985 1986 R
	A	YFM 80 T/U	80 1987 1988 R
	A	YFM 100 T/U CHAMP	100 1987 1988 R
	A	YFM 100 W/A/B CHAMP	100 1989 1991 R
	A	YFA 1 125 BREEZE	125 1989 1991 R
FSB734	YAMAHA	M RS 125	125 1975 F
		M XC 180 GYGNUM	180 1983 1985 R
		M RD 200 DX	200 1975 1978 R
		M RS 200 C	200 1975 1980 R
		M RS 200	200 1979 F/R
		M TW 200 T/U/W	200 1987 1988 F
		M DT 250 MX	250 1975 1980 R
		M IT 250 H - J - K	250 1981 1983 R
		M IT 250 L	250 1984 R
		M TY 250 H	250 1981 1983 R
		M YZ 250 H	250 1981 R
		M XT 350 4 VALVES	350 1985 R
		M DT 400 MX	400 1975 1977 R
		M SR 400 (3HT1)	400 1985 2000 R
		M SR 400 (BC-RH01J)	400 2001 R
		M SR 400 (RH051)	400 2014 R
		M IT 465 H - I	465 1981 1982 R
		M YZ 465 G - H - J - U	465 1980 R
		M YZ 490	490 1985 1987 R
		M YZ 490 J	490 1982 1982 R
		M SR 500	500 1978 1982 R
		M SR 500	500 1993 R
		M XT 500	500 1976 1981 R
		M XT 500 (Austria)	500 1983 R
		M XT 550	550 1982 1983 F/R
		M TT 600 N	600 1985 1988 R
		M XT 600 4 VALVES	600 1984 1985 R
		M XT 600 Z TENERE	600 1983 1984 R
FSB735	YAMAHA	M RD 250 A - B - C	250 1974 1977 R
		M RD 250 LC	250 1980 R
		M RD 250 LC	250 1981 1983 R



CC FROM TO FRONT / REAR

CC	FROM	TO	FRONT / REAR
	M	RD 350 A - B	350 1974 1976 R
	M	RD 350 LC	350 1980 R
	M	RD 350 LC	350 1980 R
	M	RD 350 S	350 1974 1976 R
	M	XS 360 B	360 1975 1975 R
	M	XS 650	650 1975 1976 R
	M	XS 650	650 1977 1981 R
	M	XS 650 SE	650 1981 R
FSB736	SINNIS	M QM 125-2 C Vista 125	125 2008 R
	YAMAHA	M XS 250 C	250 1980 R
		M XS 250 D - E	250 1979 1981 R
		M XS 250 SE - SF SPECIAL	250 1979 1981 R
		M YP 250 MAJESTY	250 1996 1997 R
		M XS 400	400 1979 1979 R
		M XS 400 SE	400 1980 1981 R
		M XS 400 SPECIAL	400 1982 R
		M XS 400 DOHC	400 1982 R
	YAMAHA ATV	A YFM 400 BIG BEAR (All Models)	400 2000 2007 R
FSB737	YAMAHA	M YZ 125 K - N - L	125 1983 1984 R
		M YZ 125	125 1985 1987 R
		M IT 200	200 1984 F/R
		M TY 250 S - RS	250 1984 1990 F
FSB738	MBK	M ACTIVE 50	50 1990 F
		M BOOSTER 50	50 1994 F/R
		M BOOSTER 50 R	50 1994 1995 R
		M BOOSTER 50 TRACK	50 1996 1998 R
		M BOOSTER 50 / SPIRIT	50 1996 R
		M FIZZ 50	50 1994 R
		M FLIPPER 50	50 1998 R
		M FORTE 50	50 1995 R
		M ACTIVE 75	75 1990 F
		M ACTIVE 80	80 1990 F
	YAMAHA	M 50 BELUGA	50 1990 1995 F
		M 50 BREEZE	50 1994 1996 R
		S BWS 50	50 1992 1994 F/R
		S BWS / ZUMA II 50	50 1995 R
		M CW 50 RS	50 1995 R
		S CY 50 JOG-IN	50 1991 1995 R
		M DT 50	50 1988 1992 F/R
		M DT 50 R	50 1993 1997 R
		M 50 GRAFIX	50 1993 F/R
		S JOG 50	50 1990 1991 F/R
		M MINI 50 L SHAFT	50 1983 R
		M 50 TRAFIC	50 1993 F/R
		M V 50 M	50 1983 F/R
		M YE 50 ZEST	50 1993 1995 R
		M 50 ZUMA	50 1996 R
		M 80 BELUGA	80 1990 F
		M DT 80 (Espana)	80 F/R
		M DT 80 LC (Espana)	80 1989 R
		M PW 80	80 1991 R
		M T 80 TOWNMATE	80 1983 1997 F/R
		M V 80	80 1983 F/R
		M RX 100	100 1983 1996 F/R
		M 105 CRIPTON	105 1986 1998 R
		M XT 125	125 1976 R
	YAMAHA 3 WHEELERS	A YT 60 L/N TRI-ZINGER	60 1984 1985 R
	YAMAHA ATV	A YF 60 S (MOTO4)	60 1986 2000 R
		A YFM 80 T/U	80 1987 1988 F
		A YFM 100 T/U CHAMP	100 1987 1988 F
FSB739	MBK	M ACTIVE 50	50 1989 F/R
		M ACTIVE 50	50 1990 R
		M ACTIVE 75	75 1990 R
		M ACTIVE 80	80 1989 F/R
		M ACTIVE 80	80 1990 R
	YAMAHA	M 50 BELUGA	50 1989 F/R
		M 50 BELUGA	50 1990 1995 R
		M CA 50 SALIENT	50 1983 1986 R
		S CY 50 JOG-IN	50 1991 1995 F
		M JOG 50 (Brasil)	50 R
		M JOG 50 (Espana)	50 1988 R
		M LC 50 M BOP	50 1980 F/R
		M MINT 50	50 1996 R
		M MS 50	50 1985 1986 R
		M RS 50 CHAMP	50 1988 R
		M SA 50 M - ME PASSOLA	50 1980 1984 R
		M SG 50 STING	50 1984 F/R
		M SH 50 RAZZ	50 1993 R
		M 80 BELUGA	80 1990 R
		M PW 80	80 1991 F



			CC	FROM	TO	FRONT / REAR
...FSB739		M	JOG 90 (Brasil)	90		R
		M	JOG 90	90	1990 1994	R
FSB740	HONDA	M	NX 250	250	1988 1990	R
		M	NX 250 DOMINATOR	250	1988 1990	R
		M	NX 250 DOMINATOR	250	1991 1993	R
		M	XL 250 S	250	1978 1981	R
		M	XL 250 R	250	1982 1988	R
		M	XL 250	250	1991	R
		M	XL 250 DEGREE	250	1991 1997	R
		M	XLX 250	250	1984	R
		M	XR 250 Z - SZ - SA	250	1979 1980	R
		M	XR 250 RB - RD	250	1981 1983	R
		M	XR 250 RE - RH	250	1984 1987	R
		M	XL 350 R	350	1985 1985	R
FSB741	HONDA	M	CB 550 F - F1 - F2	550	1978	R
		M	CB 550 K3	550	1978	R
FSB742	HONDA	M	CB 250	250	1973 1975	R
		M	CB 250 G5	250	1974 1976	R
		M	CJ 250 I	250	1977	R
		M	CB 350 K4	350		R
		M	CB 360 G5 all models	360	1975	R
		M	CJ 360 T all models	360	1978	R
		M	CB 400 F - F1 - F2	400	1975 1979	R
	HONDA 3 WHEELERS	A	ATC 250 SX / ES BIG RED	250	1985 1987	R
	HONDA ATV	A	TRX 250 Fourtrax	250	1985 1987	R
		A	TRX 300 (2WD) Fourtrax	300	1988 2000	R
		A	TRX 300 (4WD) FW Fourtrax	300	1988 2000	R
FSB743	HONDA	M	CR 250 RZ-A	250	1979 1980	R
		M	XL 500 S	500	1980 1981	F
FSB744	HONDA	M	CR 250 RS	250	1981 1981	F
		M	CR 250 RB	250	1981 1981	F
		M	XR 250 RB - RD	250	1981 1983	F
		M	CR 450 RB	450	1981 1981	F
		M	CR 480 RC	480	1982 1982	F
		M	XR 500 R - RB	500	1981 1983	F
FSB745	HONDA	M	CR 125 RC	125	1982 1983	F/R
		M	CR 125 RD	125	1983 1984	F
		M	CR 250 RC	250	1982 1982	F
		M	CR 250 RD	250	1983 1983	F
		M	CR 480 RD	480	1983 1983	F
FSB746	HONDA	M	CR 125 RD	125	1983 1984	R
		M	CR 125 RE	125	1984 1985	R
		M	MBX 125 RWB	125	1984 1986	R
		M	CR 250 RD	250	1983 1983	R
		M	CR 250 RE-F	250	1984 1985	R
		M	XL 350 R	350	1983 1984	F
		M	CR 480 RD	480	1983 1983	R
		M	CR 500 RE-F	500	1984 1985	R
FSB747	HONDA	M	CR 125 RS	125	1979 1981	F
		M	CR 125 RZ	125	1979 1981	F
		M	CR 125 RA	125	1979 1981	F
		M	CR 125 RB	125	1979 1981	F
		M	CR 250 RZ-A	250	1979 1980	F
		M	XR 500 SA - SZ	500	1979 1980	F
FSB748	HONDA	S	CH 250 ELITE/SPACY	250	1985 1986	R
		S	CN 250 HELIX-FUSION	250	1992 1993	R
FSB749	HONDA	M	CB 175 all models	175	1974 1976	R
		M	CB 200 B - T	200	1977 1979	R
		M	CB 250 RS	250	1981 1984	R
		M	CL 250 SC	250	1981	R
		M	MOV 250 F	250	1988	R
		M	VT 250 F-II	250	1982 1982	R
		M	VT 250 Z	250	1982 1987	R
		M	VT 250 F-II	250	1983 1984	R
		M	VT 250 F INTEGRA	250	1987	R
		M	VTZ 250	250	1988	R
		M	XL 500 S	500	1980 1981	R
FSB750	HONDA	M	CR 250 RS	250	1978	R
		M	CR 450 RB	450	1981 1981	R
FSB751	HONDA	M	XL 500 R	500	1982 1984	F
		M	XL 500 R PARIS DAKAR	500	1982 1984	F
FSB753	ARCTIC CAT	A	50 DVX (4T)	50	2006 2008	F
		A	50 Utility	50	2006 2008	F
		A	50-Y6 Youth (2T)	50	2004 2006	F
		A	90 DVX	90	2006 2010	F
		A	90 DVX SE	90	2009	F
		A	90 Reverse Gear Model	90	2010 2012	F
		A	90 Utility (2 x 4)	90	2006 2010	F
		A	90-Y12 Youth (2T-4T)	90	2002 2005	F
		A	150 Utility 2x4	150	2009 2010	F



			CC	FROM	TO	FRONT / REAR
	BOMBARDIER ATV	A	DS 50 (2 STROKE)	50	2002 2006	F
		A	QUEST 50	50	2003 2004	F
		A	DS 90 (2 STROKE / 4 STROKE)	90	2002 2006	F
		A	QUEST 90 (2 STROKE / 4 STROKE)	90	2003 2004	F
	CAN AM ATV	A	DS 70 (2x4/4T) Mini	70	2008	F
		A	DS 90 Mini 4 Stroke	90	2007	F
	HONDA ATV	A	TRX 70 Fourtrax	70	1986 1987	F
	KYMCO ATV	A	MAXXER 50	50	2005	F
		A	Mongoose 50 (2T)	50	2004 2008	F
		A	Mongoose 50 (4T) (Rear disc model)	50	2008 2009	F
		A	Mongoose 70 (4T)	70	2007 2009	F
		A	KXR 90 MONGOOSE	90	2002 2010	F
		A	MAXXER 90	90	2005 2006	F
	POLARIS ATV	A	PREDATOR 50	50	2004 2006	F
		A	SCRAMBLER 50	50	2001 2006	F
		A	PREDATOR 90	90	2003 2006	F
		A	SCRAMBLER 90	90	2001 2003	F
		A	SPORTSMAN 90	90	2001 2010	F
	QUADZILLA	A	ZR 50	50	2007 2009	F
FSB754	HONDA	M	PXR 50 ALL MODELS	50	1985 1995	R
	MBK	M	EVASION 50 (ruote in lega diritte)	50		F/R
		M	HARDROCK 50 (ruote in lega diritte)	50		F/R
		M	MAGNUM 50 (ruote in lega diritte)	50		F/R
		M	PASSION 50 (ruote in lega diritte)	50		F/R
	PEUGEOT	M	ST 50 RAPIDO	50		F/R
		M	SX 50	50		R
		M	SC 80	80		R
FSB755	HONDA	M	XBR 500 S - F - G - H	500	1985	R
		M	XLV 750 R - RD - RF	750	1984 1988	R
	HONDA ATV	A	TRX 250 TM2 Re Con	250	1997 2014	R
		A	TRX 250 EX	250	2001 2008	R
		A	TRX 250 TE2 Re Con ES	250	2002 2014	R
		A	TRX 250 X	250	2009 2011	R
	KYMCO	M	HIPSTER 125	125	1999	R
		M	K-PIPE 125	125	2012 2013	R
		M	PULSAR 125	125	1999 2013	R
		M	STRYKER 125	125	2001 2006	R
		M	ZING 125 / ZING II 125	125	1997 2013	R
		M	HIPSTER 150	150	1999	R
		M	STRYKER 150 (Off-Road)	150	2000 2006	R
FSB756	E-TON ATV	A	AXL 50 Lightning 50	50	1999 2000	F
		A	BXL-50 Draco	50	2005 2006	F
		A	NXL 50 Lightning 50	50	2001 2002	F
		A	TXL 50 Wizz 50	50	1998 1999	F
		A	Viper 70 RLX 70/70M (2T/4T)	70	2005 2009	F
		A	AXL 90 Thunder	90	1999 2000	F
		A	NXL 90 Thunder	90	2001 2002	F
		A	RXL 90 Viper 90	90	2003 2006	F
		A	RXL 90 R Viper 90 R Reverse (2T/4T)	90	2003 2009	F
		A	BXL 100 Draco	100	2005 2006	F
	HONDA	M	CRM 50	50	1988 1992	R
		M	CR 80 R2F/R2G	80	1985 1986	R
		M	CR 80 R	80	1986 1991	R
		M	CRM 80	80	1988 1992	R
		M	MB 80	80	1980	R
	KAWASAKI ATV	A	KFX 50 / KSF 50	50	2007 2009	F
		A	KFX 90 / KSF 90	90	2007 2010	F
	KYMCO ATV	A	MXer 90	90	2004	F
	PGO ATV	A	X Rider 150	150	2004 2005	F
	POLARIS ATV	A	Outlaw 50	50	2007 2010	F
		A	Predator 50 (2 stroke)	50	2004 2006	F
		A	Outlaw 90	90	2007 2010	F
	TGB ATV	A	Hornet 50 Quad	50	2004 2005	F
		A	Hornet 90 Quad	90	2004 2005	F
FSB757	HONDA	M	CR 125 RG	125	1986 1986	R
		M	CR 250 RG	250	1986 1986	R
		M	CR 500 RG	500	1986 1986	R
FSB758	HONDA	M	PXR 50 ALL MODELS	50	1985 1995	F
FSB759	FANTIC	M	RAIDER 250 (FM. 259)	250	1985	R
	GILERA	M	DAKOTA 350	350	1986	R
		M	ER 350	350	1987	R
		M	ER 500	500	1987	R
FSB760	ARCTIC CAT	A	50-Y6 Youth (2T)	50	2004 2006	R
	HONDA	M	CD 175 all models	175	1971 1978	F
	HONDA 3 WHEELERS	A	ATC 90	90	1973 1978	R
		A	ATC 110	110	1979 1985	R
		A	ATC 125	125	1984 1987	R
		A	ATC 185	185	1980 1983	R
		A	ATC 200 (Drum Brake)	200	1981 1986	R
		A	ATC 250 R	250	1981 1982	R

M = MOTORCYCLE
S = SCOOTER
A = ATV
Sn = SNOWMOBILE



			CC	FROM	TO	FRONT / REAR			
...FSB760	HONDA ATV	A	ATC 250 SX / ES BIG RED	250	1985	1987	F		
		A	TRX 90	90	1993	2009	R		
		A	TRX 125 Fourtrax	125	1985	1988	R		
		A	TRX 200 (4WD)	200	1990		R		
		A	TRX 200 Fourtrax	200	1984	1985	R		
		A	TRX 200 Fourtrax	200	1986	1998	R		
	POLARIS ATV	A	FL 250 ODYSSEY	250	1977	1984	R		
		A	PHOENIX 200 (Rear drum model)	200	2005	2010	R		
		A	SAWTOOTH 200 (Rear drum model)	200	2006		R		
FSB761	HONDA	M	CB 700 SC NIGHT HAWK	700	1984		R		
		M	VF 700 C MAGNA	700	1985		R		
		M	VT 700 C SHADOW	700	1986		R		
		M	VT 700 C SHADOW	700	1987		R		
		M	750 BLACK WIDOW	750	2001		R		
		M	MAGNA 750	750	1993		R		
		M	VFR 750 C V45 MAGNA	750	1988		R		
		M	VT 750 C SHADOW	750	1986	1996	R		
		M	VT 750 C SHADOW	750	1997	2009	R		
		M	VT 750 AMERICAN CLASSIC EDITION	750	1998	1998	R		
		M	VT 750 DC Black Widow	750	2001	2004	R		
		M	VT 750 DC Shadow Spirit	750	2007	2009	R		
		M	VT 750 C2 SHADOW BLACK SPIRIT	750	2010		R		
		M	VT 750 S	750	2010	2012	R		
		M	PC 800 PACIFIC COAST	800	1989	1997	R		
		M	VT 800 C	800	1988		R		
		M	VT 1100 C	1100	1985	1993	R		
		M	VT 1100 C SHADOW	1100	1994		R		
		HONDA ATV	A	TRX 350/TRX 350D Fourtrax/Foreman	350	1986	1989	R	
			A	TRX 500 FGA Fourtrax Foreman Rubicon Gpscape	500	2001	2005	R	
	A		TRX 500 FA Fourtrax Rubicon	500	2001	2004	R		
	A		TRX 500 FGA Fourtrax Foreman Rubicon Gpscape	500	2005	2009	R		
	A		TRX 500 TM/FE/FA/FMA/FPE/FPM Fourtrax Foreman	500	2005	2010	R		
	A		TRX 500 FA/FAA Fourtrax Foreman Rubicon	500	2005	2010	R		
	A		TRX 500 FPA9 Fourtrax Foreman Rub. Gpscape EPS	500	2009		R		
	M		VT 800 C	800	1988	1990	R		
	KAWASAKI								
	FSB762	HONDA	S	CN 250 HELIX-FUSION	250	1988	1989	R	
			S	CN 250 HELIX-FUSION	250	1990	1992	R	
		ITALJET	M	VELOCIFERO 50	50	1994	2002	F	
			M	ELYSEO 125	125	1998	2000	R	
	PIAGGIO	M	HEXAGON 250	250	1998	1999	R		
	FSB763	YAMAHA	M	SR 125	125	1993	1996	R	
			M	YZ 125 K - N - L	125	1983	1984	F	
			M	IT 250 L	250	1984		F	
			M	YZ 250 J - K - L	250	1982	1984	F	
M			IT 465 H - I	465	1981	1982	F		
M			YZ 465 G - H - J - U	465	1980		F		
M			IT 490 L	490	1983	1984	F		
M			YZ 490 J	490	1982	1982	F		
M			YZ 490 K - L	490	1983	1984	F		
M			TT 600 L	600	1983	1984	F		
FSB764			SUZUKI	M	RM 80 XD - XE - XF - XZ	80	1981	1985	R
				M	RM 80 X	80	1986	1989	R
	M	YZ 50 G - H - J - K		50	1980	1983	F/R		
	M	YZ 60		60	1985		F/R		
	YAMAHA	M	PW 80 K	80	1983	1990	F/R		
		M	TY 80	80	1977		F		
		M	TY 80	80	1983		F		
		M	YZ 80	80	1977	1979	F		
		M	YZ 80	80	1980	1985	F/R		
		M	YZ 80	80	1986	1992	R		
		M	TT-R 90	90	2000	2004	F		
		M	TT-R 110	110	2008		F		
		FSB765	YAMAHA	M	XV 400 VIRAGO	400	1988		R
				M	XVS 400	400	1998	1999	R
				M	XV 535 VIRAGO	535	1987	1994	R
				M	XV 535 VIRAGO	535	1995	1998	R
M	KJ 650			650	1980		R		
M	XJ 650 TURBO			650	1983		R		
M	XVS 650 DRAG STAR			650	1997		R		
M	XVS 650 A DRAG STAR CLASSIC			650	1998		R		
M	XJ 750			750	1982	1984	R		
M	XV 750 VIRAGO			750	1994	1997	R		
M	XV 1000 TR 1			1000	1981		R		
M	XV 1000 SE MIDNIGHT SPECIAL			1000	1983		R		
M	XV 1000 VIRAGO			1000	1986	1988	R		
M	XV 1100 VIRAGO			1100	1989	1993	R		
M	XV 1100 VIRAGO			1100	1994	1998	R		
FSB766	YAMAHA			M	SR 250	250	1987	F	
FSB767	YAMAHA			M	DT 250 MX	250	1975	1980	F
				M	IT 250 G	250	1980		R



			CC	FROM	TO	FRONT / REAR			
YAMAHA ATV	YAMAHA ATV	M	SR 250 SE	250	1980	1982	F		
		M	YD 250 S	250	1991		R		
		M	YZ 250 D - E - F	250	1976	1979	R		
		M	DT 400 MX	400	1975	1977	F		
		M	YZ 400 D - E - F	400	1977	1979	R		
		M	IT 425 G	425	1980		R		
		M	IT 500 G - H	500	1980	1981	R		
		M	TT 500 G - H	500	1976	1981	R		
		M	XT 500	500	1976	1981	F		
		A	YFM 350 ER W/A/D	350	1989	1992	F		
		FSB768	BETA	M	RX 50	50	1984		R
				M	RX 125	125	1984		R
FSB769	YAMAHA	M	TX 500	500	1975	1977	R		
		M	XS 500 B	500	1975	1977	R		
		M	XJ 550	550	1981	1984	R		
		M	XZ 550	550	1982	1984	R		
		M	XZ 550 S	550	1984	1986	R		
		M	XV 750 SE	750	1981		R		
		M	XV 750	750	1989	1993	R		
		M	XV 750 VIRAGO	750	1992	1993	R		
FSB770	YAMAHA	M	XS 250 C	250	1980	F			
FSB772	YAMAHA	M	BL 125 BELUGA	125	1988	1992	F		
		M	BL 125 BELUGA	125	1993	1995	F		
		M	RIVA 125 XX	125	1993		F		
		M	XC 125 BELUGA	125	1993		F		
FSB773	SUZUKI	M	GT 250 A - B - C	250	1973	1978	R		
		M	GT 250 K - L - M	250	1973	1978	R		
		M	GT 380 J	380		1972	R		
		M	GT 380 K/L/M/A/B	380	1973	1977	R		
FSB775	SUZUKI	M	GS 400 B - C	400	1977	1978	R		
		M	GSX 400 TX - LX	400	1981	1983	R		
		M	GT 500 A - B	500	1976	1978	R		
		M	T 500 all models	500	1968	1975	R		
		M	GT 550 J	550	1972	1972	R		
		M	GT 550 K - L - M	550	1973	1975	R		
		FSB776	SUZUKI	M	JR 50	50	1993	2003	F
				M	PE 175 T - X	175	1980	1981	R
				M	PE 175 Z	175	1982		R
				FSB777	HYOSUNG	M	GV 125 AQUILA	125	2001
		M	GV 125			125	2005		R
		M	RT 125 KARION			125	2002	2006	R
M	RT 125 D KARION	125	2007				R		
M	XR 125 OFFROAD	125	1999				R		
M	GV 250 AQUILA	250	2004			2007	R		
M	GV 250	250	2008				R		
A	KSF 80 / KFX 80	80	2003			2006	R		
A	KSF 90 / KFX 90	90	2006			2007	R		
M	PE 175 Z	175	1982				F		
M	RM 250 F - IG - G	250	1985			1986	R		
M	RM 250 E	250	1984				R		
M	RM 250 T	250	1980		F				
M	RM 400 T	400	1980		F				
M	RM 465 X - Z	465	1981	1982	R				
A	LT 80 all models	80	1987	2007	R				
A	LT-Z 90 QUADSPORT	90	2006		R				
A	LT 125 F/G/H	125	1985	1987	R				
FSB777	ATALA	M	HACKER 50	50	1996		R		
		M	SCHEGGIA 50	50	1998		R		
		M	MANTIS 50	50	1998		R		
	CAGIVA	M	PROGRESS 50	50	1997		R		
		M	HUNTER 50	50	1995		R		
		M	PADDOCK 50 ST	50	1996		R		
	DERBI	M	PREDATOR 50 0.2	50	1999		R		
		M	PROGRESS 50	50	1997		R		
		M	RECORD 50	50	1998		R		
	GARELLI	M	VAMOS 50	50	1994		R		
		M	VAMOS 50 R	50	1995		R		
		M	KRS 50	50	2002		R		
ITALJET	M	FREELAND 125	125	2002		R			
	M	FREELAND 150	150	2002		R			
	M	TORPEDO 50	50	1997		R			
PGO	M	VELOCIFERO 50	50	1994	2002	R			
	S	Velocifero 50	50	1998	2003	R			
	M	T-REX 50	50	1999	2004	R			
M	T-REX 110	110	1999	2004	R				
M	CHARGE 125 A / B	125	2001	2002	R				
S	Ligero 125	125	2006	2008	R				
S	Ligero 125 (4T)	125	2008	2012	R				



CC FROM TO FRONT / REAR

FSB777	PUCH	M	LIDO 75 (scooter)	75	1986		F/R
	RIZZATO	M	ATALA HACKER 50	50	1995		R
	SUZUKI	M	ADDRESS 50 (SPAIN)	50			F/R
		M	AY 50 KATANA (Brembo caliper)	50	1997		R
		M	AY 50 WR KATANA	50	1998		R
		M	AY 50 W KATANA	50	1998		R
		M	CP 50 CHF	50	1985		F/R
		M	CP 50	50	1991	1993	F/R
		M	LIDO 50	50	1989	1990	F/R
		M	SEPIA 50	50	1992	1995	R
		M	UF 50 ESTILETE	50	2000	2002	R
		M	UX 50 ZILLION	50	1998	2002	R
		M	ZZ 50	50	1992	1995	R
		M	LIDO 75	75	1989		R
		M	AH 80	80	1992	1994	R
		M	CP 80 CHF	80	1985	1993	F/R
		S	ADDRESS 110	110	2015		R
		S	Access	125	2007		F/R
		M	AN 125	125	1995	2000	R
		M	LIDO 125 VARIO	125	1990	1993	R
		M	AN 150	150	1997	2000	R
	SUZUKI ATV	A	LT 160 (All models)	160	1989	2004	F
FSB778	SUZUKI	M	RM 125 E	125	1984	1984	F
		M	RM 250 D	250	1983		F
		M	RM 250 E	250	1984		F
		M	RM 500 D - E	500	1983	1984	F
FSB779	SUZUKI	M	RM 250 XZ	250	1981	1982	F
		M	RM 465 X - Z	465	1981	1982	F
	SUZUKI 3 WHEELERS	A	ALT 125 D	125	1983	1984	R
	SUZUKI ATV	A	LT 125 D	125	1983	2000	R
FSB780	SUZUKI	M	GS 550 B - C - D	550	1977	1978	R
		M	GT 550 A - B	550	1976	1977	R
FSB781	FANTIC	M	SPORT 125 HP1 (FM.265)	125	1985		R
		M	SPORT 125 MK II (f.a.tel.1706338)	125	1985		R
	GARELLI	M	GTA 125	125	1986	1986	R
FSB782	SUZUKI	M	RE 500 S A - M	500	1975	1977	R
		M	GV 700 GL	700	1985		R
		M	GT 750 A - B - K - L - M	750	1973	1977	R
	SUZUKI ATV	A	LT 250 EF	250	1985	1986	R
		A	LT-F 250 4WD QUADRUNNER	250	1987	2002	R
		A	LT 300 E	300	1987	1989	R
		A	LT-F 300 KING QUAD	300	1991	2001	R
		A	LT-F 300 KING QUAD	300	2002		R
		A	LT-A 500 F QUADMASTER	500	2000	2001	R
		A	LT-F 500 FW/FX/F1 QUADRUNNER (left)	500	1998	2002	R
FSB784	SACHS	M	ROADSTER 800	800	2001		R
	SUZUKI	M	VS 600 GL INTRUDER	600	1997	1999	R
		M	GV 700 GL MADURA	700	1984		R
		M	VS 700 GL INTRUDER	700	1985		R
		M	VS 750 INTRUDER (All Models)	750	1985	1991	R
		M	INTRUDER M800 (VZ800)	800	2005	2013	R
		M	INTRUDER C800 - spoke wheel (VL 800)	800	2006	2013	R
		M	INTRUDER C800C - cast wheel (VL 800)	800	2007	2013	R
		M	INTRUDER M800 Z (VZ800)	800	2009	2010	R
		M	INTRUDER C800B - cast wheel (VL 800)	800	2014		R
		M	INTRUDER M800 /T (VZ800)	800	2014		R
		M	VL 800 INTRUDER VOLUSIA	800	2001	2005	R
		M	VS 800 S INTRUDER	800	1991	1992	R
		M	VS 800 GL INTRUDER (VS52B)	800	1992	1999	R
		M	VZ 800 MARAUDER / K7	800	1997	2003	R
	SUZUKI ATV	A	LT-F 400 X	400	1991	2000	R
FSB785	SUZUKI	M	DR 250 S	250	1983	1984	F
		M	RM 250 N	250	1979		R
		M	RM 250 T	250	1980		R
		M	RM 400 N	400	1979	1979	R
		M	RM 400 T	400	1980		R
FSB786	SUZUKI	M	RM 125 D - X - Z	125	1981	1983	R
		M	RM 125 X - Z	125	1981	1983	R
		M	RM 125 E	125	1984	1984	R
		M	RM 125 F - G	125	1985	1986	R
		M	RM 125 H	125	1987		R
		M	RM 250 D	250	1983		R
		M	RM 250 XZ	250	1981	1982	R
FSB787	SUZUKI	M	adaptable to 130x28 front and rear drums				F/R
FSB790	SUZUKI	M	DR 750 S BIG	750	1988		R
FSB792	ATALA	M	BYTE 50	50	1996		R
		M	HACKER 50	50		1995	R
	SUZUKI	M	ADDRESS 50	50	1990	1991	F/R
		M	ADDRESS 50	50	1992	1995	R
		M	AH 50	50	1993	1995	F/R



CC FROM TO FRONT / REAR

		M	SEPIA AU 50 ZZ	50	1996	1998	R
		M	TUNE 50	50	1993	1995	R
FSB793	KAWASAKI	M	KH 250 B1 - S	250	1977	1982	R
		M	S1 250 B	250	1975		R
		M	KH 400 A3-5	400	1976	1981	R
FSB794	KAWASAKI	M	KH 500 H1 - B/D/E	500	1974	1975	R
		M	KH 500 A8	500	1976		R
	KAWASAKI ATV	A	KLF 300 BAYOU 4x4 C Series (left)	300	1989	2004	R
		A	KVF 300 PRAIRIE (2x4/4x4)	300	1999	2002	R
		A	KLF 400 BAYOU 4x4 B Series (left)	400	1993	1999	R
		A	KVF 400 PRAIRIE (2x4/4x4)	400	1997	2002	R
FSB795	KAWASAKI	M	Z 900 A 4	900	1977	1978	R
FSB796	MOTO GUZZI	M	V 7 700 SPECIAL	700	1969	1971	F
		M	V 750 750 SPORT	750	1972	1974	F
		M	CALIFORNIA 850 GT	850	1972	1974	F
		M	GT 850	850	1972	1974	F
		M	T 850	850	1974	1975	R
FSB797	KAWASAKI	M	KE 125 A4 - A10	125	1976	1985	F
		M	KX 125 A3 - A7	125	1974	1980	F
		M	KDX 175 all models	175	1980	1982	F
		M	KE 175 B1 - B3	175	1976	1978	F/R
		M	KE 175 D1 - D5	175	1979	1983	F
		M	KL 250 A3 - A4	250	1980	1984	F
		M	KL 250 C1	250	1980	1984	F
		M	KLX 250	250	1979	1980	F
FSB799	KAWASAKI	M	KDX 250 B1	250	1979		F
		M	KL 250 A1 - A2	250	1978	1979	F
		M	KX 250 A all models	250	1974	1979	F
		M	KX 250 B2 - B3	250	1980	1981	F
		M	KX 420 A1 - A2	420	1980		F
	KAWASAKI 3 WHEELERS	A	KLT 200 All Models	200	1981	1984	R
		A	KLT 250 All Models	250	1982	2000	R
		A	KXT 250 TECATE	250	1984	2000	F
	KAWASAKI ATV	A	KLF 185 BAYOU A2 / A3 / A4	185	1986	1988	F
		A	KLF 220 BAYOU A Series	220	1988	2002	F
		A	KLF 250 BAYOU A Series	250	2003	2010	F
FSB800	KAWASAKI	M	S1 250 B	250	1975		F
		M	Z 250 LTD	250	1983		F
		M	Z 250 B1 - B2	250	1980	1983	F
		M	Z 250 C1 - C2	250	1981	1983	F
		M	Z 250 G1 - G2	250	1981	1983	F
FSB802	KAWASAKI	M	KX 60 A1 - A2 - B1/6	60	1985	1991	F/R
		M	KX 80 E1	80	1983		R
		M	KX 80 E2	80	1984	1986	R
		M	KX 80 H - K2	80	1987	1987	R
		M	KLX 110 R	110	2002		F
FSB804	BMW	M	R 65 650 LS	650		1981	R
FSB805	BMW	M	K 75 750	750	1984	1988	R
FSB806	BMW	M	R 50/5 500	500	1969	1975	F
		M	R 60/5 600	600		1975	F
		M	R 60/6 600	600		1975	F
		M	R 75/5 750	750		1975	F
FSB807	BULTACO	M	LOBITO 125 Mk3	125	1970	1972	F/R
		M	LOBITO 125 Mk6	125	1972	1973	F/R
		M	LOBITO 125 Mk7	125	1973	1974	F/R
		M	LOBITO 125 Mk8	125	1974	1976	F/R
		M	PURSANG MK6 125	125	1972	1973	F
		M	PURSANG MK7/8 125	125	1973	1976	F
		M	PURSANG MK9 125	125	1976		F/R
		M	SHERPA 125	125			F
		M	TRIAL 125	125			F/R
		M	SHERPA 150	150			F
		M	SHERPA 151	151			F
		M	PURSANG MK6 175	175	1972	1973	F
		M	PURSANG MK6 200	200	1972	1973	F
		M	PURSANG MK9 200	200	1976		F/R
		M	LOBITO 250	250			F/R
		M	PURSANG MK6 250	250	1972	1973	F
		M	PURSANG MK7/8 250	250	1973	1976	F
		M	PURSANG MK10 250	250	1977		F
		M	PURSANG MK11 250	250	1977		F
		M	PURSANG MK12 250	250	1978		F
		M	SHERPA 250 A	250			F/R
		M	SHERPA 250 I	250			F/R
		M	SHERPA 250 N	250			F/R
		M	TRIAL 250	250			F/R
		M	PURSANG MK6 350	350	1972	1973	F
		M	SHERPA 350 N	350			F/R
		M	SHERPA 350 I	350			F/R
		M	SHERPA 350 A	350			F/R

M = MOTORCYCLE
S = SCOOTER
A = ATV
Sn = SNOWMOBILE



			CC	FROM	TO	FRONT / REAR	
...FSB807		M	TRIAL 350	350		F/R	
		M	PURSANG MK7/8 360	360	1973	1976	F
FSB809	DERBI	M	all models 50	50		1982	F/R
FSB812	HUSQVARNA	M	CR 125	125	1983	1984	F
		M	CR 125	125	1985	1995	R
		M	RC 125	125	1983	1984	F
		M	WR 125	125	1986	1986	R
		M	WR 125	125	1987	1990	R
		M	WRE 125	125	1988		R
		M	CR 240	240	1981	1982	F
		M	CR 240	240	1987		R
		M	RC 240	240	1981	1982	F
		M	WR 240	240	1985		R
		M	WR 240	240	1986		R
		M	WR 240	240	1987	1990	R
		M	WRK 240	240	1988		R
		M	CR 250	250	1981	1982	F
		M	CR 250	250	1985	1995	R
		M	RC 250	250	1981	1982	F
		M	WR 250	250	1987	1989	R
		M	XC 250	250	1987		R
		M	WRK 260	260	1988		R
		M	WR 400	400	1985		R
		M	WR 400	400	1986		R
		M	WR 400	400	1987		R
		M	AE 430	430	1988		R
		M	AUTO 430	430	1987		R
		M	CR 430	430	1981	1982	F
		M	CR 430	430	1987		R
		M	OR 430	430	1981	1982	F
		M	RC 430	430	1981	1982	F
		M	WR 430	430	1981	1982	F
		M	WR AE 430	430	1987		R
		M	WRE 430	430	1981	1982	F
		M	XC 430	430	1981	1982	F
		M	XC 430	430	1987		R
		M	CR 500	500	1985		R
		M	XC 500	500	1987		R
		M	510	510	1986		R
		M	TC 510	510	1988		R
		M	TE - AC - LC 510	510	1987		R
FSB813	HUSQVARNA	M	WR 125	125	1983	1985	F
		M	WRE 125	125	1983	1984	F
		M	CR 240	240	1983	1986	F
		M	RC 240	240	1983		F
		M	WR 240	240	1983	1984	F
		M	WR 240	240	1985		F
		M	WRE 240	240	1983		F
		M	CR 250	250	1983	1984	F
		M	RC 250	250	1983		F
		M	WR 250	250	1983	1986	F
		M	WRE 250	250	1983		F
		M	WR 400	400	1985		F
		M	CR 490	490	1983		F
		M	AE 500	500	1984		F
		M	TC 500	500	1984		F
		M	TE 510	510	1984	1987	F
		M	TX 510	510	1984		F
FSB814	HONDA	M	CR 480 RC	480	1982	1982	R
	KTM	M	HOBBY-DUO-PRO 50 COMET 40PI-KJ	50			F/R
		M	125	125		1983	F/R
		M	CROSS 125	125	1980	1983	F/R
		M	LC - GS 125 GS	125	1983		R
		M	175	175	1972	1978	F/R
		M	175	175	1979		F
		M	CROSS 250	250		1981	F/R
FSB815	KTM	M	175	175	1979		R
		M	CROSS 250	250	1982		F/R
		M	CROSS 250	250	1983		R
		M	GS 350 ENDURO SPORT	350	1983		R
		M	GS 390 ENDURO SPORT	390	1983		R
		M	MX 495 MC LELEU	495	1982	1983	R
		M	500 CROSS	500		1982	R
		M	GS 500 K4 ENDURO	500	1983		R
FSB817	KTM	M	CROSS 250	250	1983		F
		M	500 CROSS	500		1982	F
FSB818	BENELLI	M	125	125	1976		R
		M	125 2C Dual brakes	125		1976	R
		M	125 2C	125	1976	1978	R
		M	125 2T - 2 CSE	125	1976	1978	R



			CC	FROM	TO	FRONT / REAR	
		M	250 4	250	1976		R
		M	250 C	250	1976	1978	R
		M	250 TS	250	1976	1978	R
		M	254	254	1979		R
		M	350 4 CIL.	350	1978		R
		M	500 QUATTRO	500	1976		R
	DUCATI	M	250	250		1976	R
		M	350	350		1976	R
		M	450	450		1976	R
	MOTO GUZZI	M	2C 125 4T	125	1979		R
		M	STORNELLO 160 (5 speed)	160	1971	1974	F
		M	TS 250	250	1974	1975	R
		M	254	254	1977	1981	R
		M	GTS 350	350	1974	1975	R
FSB819	MAICO	M	GSE 250 ALPHA-E	250		1983	R
		M	LINK 250	250		1983	R
		M	MX 250 TWIN	250		1983	R
		M	400	400		1983	R
		M	MX 490 TWIN	490		1983	R
		M	MX 490 LINK	490		1983	R
FSB820	MONTESA	M	MKS 50	50	1987		R
		M	COTA 123	123		1983	F/R
		M	COTA 123	123	1983		R
		M	COTA 242	242	1983		R
		M	COTA 290	290		1983	F/R
		M	COTA 304	304	1987		R
		M	TRIAL 330	330	1985		R
		M	T 348	348		1983	F/R
		M	COTA 349	349		1983	F/R
		M	COTA 349	349	1983		R
	MONTESA (HONDA)	M	MH 123	123	1983		R
		M	MH 200	200	1983		R
		M	MH 349	349	1983		R
	PUCH	M	CONDOR 50	50		1983	R
		M	MONZA 50	50	1983		F/R
		M	COBRA 75	75	1985		R
		M	COBRA 80	80	1984		R
FSB823	MZ	M	SAXON 125	125	1993	1997	R
		M	TS 125	125			F
		M	SAXON 150	150	1995		R
		M	TS 150	150			F
		M	ETZ 250	250			F/R
		M	ETZ 250	250	1982	1992	R
		M	TS 250	250			F/R
		M	FUN 251	251	1995	1996	R
		M	ETZ 301	301	1990	1992	R
		M	SAXON 500	500	1993	1998	R
FSB824	MZ	M	ETZ 125	125			F/R
		M	ETZ 125	125	1982	1992	R
		M	TS 125	125			R
		M	ETZ 150	150			F/R
		M	ETZ 150	150	1982	1992	R
		M	TS 150	150			R
FSB825	OSSA	M	CROSS 125	125	1974		F
		M	CROSS 250	250	1974		F
		M	FUEGO 250	250	1974		F
		M	TRIAL 250 (all models)	250		1980	F/R
		M	TRIAL 350 (all models)	350		1980	F/R
FSB826	CAGIVA	M	DG 350 TRIAL	350	1983		F/R
	OSSA	M	TRIAL 250 (all models)	250	1981		F
		M	TRIAL 350 (all models)	350	1981		F
	PUCH	M	BORRASCIA 50	50			F/R
		M	MINICROSS 50	50			F/R
FSB827	FB MINARELLI	M	MR 80	80			R
	OSSA	M	TRIAL 250 (all models)	250	1981		R
		M	TRIAL 350 (all models)	350	1981		R
	PUCH	M	MONZA 50	50	1984		R
		M	MONZA 50 50 (alloy wheels 160x17)	50	1984		F/R
		M	MONZA 50	50	1985		R
	RIEJU	M	MR 80	80			R
FSB828	OSSA	M	CROSS 125	125	1974		R
		M	CROSS 250	250	1974		R
		M	FUEGO 250	250	1974		R
FSB834	APRILIA	M	TUAREG 125 RALLY (Mozzi Rimoldi)	125	1986		R
		M	TUAREG 250 RALLY (Mozzi Rimoldi)	250	1986		R
	GILERA	M	R1 50	50	1990	1998	R
		M	HX 250 LC	250	1983		R
		M	RX 250 ARIZONA RALLY	250	1986		R
	KRAMER	M	80	80			F/R
	VALENTI	M	80	80			F/R



				CC	FROM	TO	FRONT / REAR		
FSB835	ZUNDAPP	M	KS 50 SUPER SPORT	50			R		
		M	KS 50 SPORT	50			R		
		M	KS 100	100			R		
FSB836	ZUNDAPP	M	SUPER COMBINETTE 429	429			F/R		
		M	SUPER COMBINETTE 433	433			F/R		
		M	FALCONETTE 435	435			F/R		
		M	KS 50 500	500			F/R		
		M	KS 75 500	500			F/R		
FSB837	BENELLI	M	S 50 LUSSO	50	1981	1987	R		
		M	S 50	50	1981	1987	R		
		M	S 50 (tutti i modelli)	50	1987		R		
	ITALJET	M	T 50	50			F/R		
		M	T 100	100			F/R		
		M	RANGER 125	125	1985		F/R		
		M	SKIPPER 125	125	1985		F/R		
		M	T 125	125			F/R		
		M	T 250	250			F/R		
		M	T 250 PIUMA	250	1985		F/R		
		M	BOSS 350 ENDURO	350			R		
		M	BOSS 350 4 T	350			F/R		
		M	CUSTOM 350	350	1985		F		
		M	CX 350	350	1985		R		
		M	EXPLORER 350	350	1985		F/R		
		S	H&H 350 2 T	350			F/R		
		M	SCOTT 350 4 T	350			F/R		
		M	T 350 PIUMA	350	1985		F/R		
		FSB838	GILERA	M	ARIZONA 125	125	1983		R
				M	ARIZONA HAWK 125	125	1986		R
M	ER 125			125	1987		R		
M	RC 125 RALLY			125	1987		R		
M	RRT 125 NEBRASKA (tubeless tires)			125	1987	2000	R		
M	RRT 125 NEBRASKA			125	1987		R		
M	RTX 125			125			R		
M	RX 125			125	1984		R		
M	ARIZONA HAWK 200			200	1986		R		
M	ER 200			200	1987		R		
M	RTX 200			200	1986		R		
M	RX 200 ARIZONA			200	1985		R		
M	RX 200	200	1985		R				
FSB839	INNOCENTI	M	LAMBRETTA 125 LI	125			F/R		
		M	LAMBRETTA 150 LI	150			F/R		
		M	LAMBRETTA 175 LI	175			F/R		
		M	LAMBRETTA 175 TV II	175			R		
FSB841	CAGIVA	M	WMX 125 CROSS	125	1986		R		
		M	WMX 125 CROSS	125	1987		R		
		M	WMX 250 CROSS	250	1987		R		
FSB842	INNOCENTI	M	LAMBRETTA J 100	100			F/R		
		M	LAMBRETTA J 125	125			F/R		
FSB843	INNOCENTI	M	LAMBRETTA 125 DL	125			F/R		
		M	LAMBRETTA 150 DL	150			F/R		
		M	LAMBRETTA 200 DL	200			F/R		
		M	LAMBRETTA 200 DL (con kit anteriore x pastiglia)	200			R		
FSB844	CAGIVA	M	ALETTA 125 ELECTRA	125		1984	R		
		M	ELEFANT 125	125		1984	R		
		M	WSXT 125 ALETTA ROSSA	125	1983		R		
		GILERA	M	RALLY 50	50	1987	1990	R	
M	RRT 125 NEBRASKA (tubeless tires)		125	1987	2000	R			
FSB845	CAGIVA	M	WMX 500	500	1984		R		
FSB846	CAGIVA	M	ALETTA 125 ELECTRA	125	1984		R		
		M	ELEFANT 125	125	1984		R		
FSB847	FANTIC	S	RSX 125	125	1981		F/R		
		M	TRIAL 125 7 DAYS(mozzi centrali)	125			R		
	GILERA	M	GIUBILEO 98	98			F		
		M	GIUBILEO 124	124			F		
	MAICO	M	GSE 250 ALPHA-E	250		1983	F		
		M	LINK 250	250		1983	F		
		M	MX 250 TWIN	250		1983	F		
	MOTO GUZZI	M	400	400		1983	F		
		M	MX 490 TWIN	490		1983	F		
		M	MX 490 LINK	490		1983	F		
		M	CROSS 50	50	1975	1976	F/R		
		M	CROSS 50	50	1976	1982	F/R		
	MOTO MORINI	M	NIBBIO 50	50	1975	1976	F/R		
		M	KJ 125	125	1984		R		
		M	MONOCILINDRO 125	125	1979		R		
		M	SPORT 250	250		1970	R		
	M	TURISMO 250	250		1970	R			
FSB849	CAGIVA	M	ALA BLU 250	250	1983		R		
		M	ALA ROSSA 250	250	1983		R		
		M	SST 250	250		1978	F		



				CC	FROM	TO	FRONT / REAR		
		M	SST 250	250	1979	1980	F		
		M	SST 250	250	1980		R		
		M	SX 250	250		1982	F/R		
		M	SX 250	250		1982	R		
		M	ALA BLU 350	350	1983		R		
		M	ALA ROSSA 350	350	1983		R		
		M	ALA ROSSA 350	350	1988		R		
		M	SST 350	350		1978	F/R		
		M	SST 350	350	1981		R		
		M	SX 350	350		1978	F/R		
		M	SX 350	350	1979	1982	F/R		
		FSB850	HUSQVARNA	M	CR 125	125	1981	1982	F/R
M	CR 125			125	1983	1984	R		
M	RC 125			125	1981	1982	F/R		
M	RC 125			125	1983	1984	R		
M	WR 125			125	1983	1985	R		
M	WRE 125			125	1983	1984	R		
M	CR 240			240	1981	1982	R		
M	CR 240			240	1983	1986	R		
M	RC 240			240	1981	1982	R		
M	RC 240			240	1983		R		
M	WR 240			240	1983	1984	R		
M	WRE 240			240	1983		R		
M	CR 250			250	1981	1982	R		
M	CR 250			250	1983	1984	R		
M	RC 250			250	1981	1982	R		
M	RC 250			250	1983		R		
M	WR 250			250	1983	1986	R		
M	WRE 250			250	1983		R		
M	RC 390			390	1978	1980	F/R		
M	CR 430			430	1981	1982	R		
M	OR 430	430	1981	1982	R				
M	RC 430	430	1981	1982	R				
M	WR 430	430	1981	1982	R				
M	WRE 430	430	1981	1982	R				
M	XC 430	430	1981	1982	R				
M	CR 490	490	1983		R				
M	AE 500	500	1984		R				
M	TC 500	500	1984		R				
M	TE 510	510	1984	1987	R				
M	TX 510	510	1984		R				
FSB851	MONTESA	M	old models	1500			F		
FSB852	BETA	M	CR - RV 250	250	1981		R		
		M	CR - RV 350	350	1980		R		
		M	GS - RV 350	350	1980		R		
		M	GS - RV 500	500	1984		R		
		MOTO MORINI	M	KANGURO 350	350		1983	R	
			M	KANGURO 350	350	1984		R	
		M	XE 350	350	1985		R		
		M	CAMEL 500	500		1983	R		
		M	CROSS 347	347		1981	R		
		FSB853	CAGIVA	M	ALA VERDE 250	250	1983		R
				M	SSX 250	250	1982		R
				M	ST 250	250	1982		R
M	ALA AZZURRA 350			350	1983		R		
M	ALA VERDE 350			350	1983		R		
MOTO MORINI	M	SX 350	350	1982		R			
	M	GT 350	350	1976	1981	R			
	M	SPORT 350	350	1981		R			
FSB854	CZ	M	JAWA 125	125		1974	F/R		
		M	JAWA 125	125	1975		R		
		S	JAWA 175	175		1974	F/R		
		S	JAWA 175	175	1975		R		
		M	JAWA 250	250		1974	F/R		
		M	JAWA 250	250	1975		R		
		M	JAWA 350	350		1974	F/R		
M	JAWA 350	350	1975		R				
FSB855	CZ	M	JAWA 125	125	1975		F		
		S	JAWA 175	175	1975		F		
		M	JAWA 250	250	1975		F		
		M	JAWA 350	350	1975		F		
FSB856	BENELLI	M	S 125 SCOOTER	125			F/R		
FSB857	BULTACO	M	PURSANG MK7/8 125	125	1973	1976	R		
		M	SHERPA 125	125			R		
		M	SHERPA 150	150			R		
		M	SHERPA 151	151			R		
		M	FRONTERA 250 all models	250			F/R		
		M	PURSANG MK7/8 250	250	1973	1976	R		
		M	PURSANG MK9 250	250	1976		F/R		
		M	PURSANG MK10 250	250	1977		R		

M = MOTORCYCLE
S = SCOOTER
A = ATV
Sn = SNOWMOBILE



			CC	FROM	TO	FRONT / REAR	
...FSB857	MONTESA	M	PURSANG MK11 250	250	1977	R	
		M	PURSANG MK12 250	250	1978	R	
		M	FRONTERA 350 all models	350		F/R	
		M	PURSANG MK7/8 360	360	1973	1976	R
		M	PURSANG MK11 370	370		R	
		M	PURSANG MK9 370	370	1976	F/R	
		M	PURSANG MK10 370	370	1977	F/R	
		M	PURSANG MK11 370	370	1977	1979	F
		M	PURSANG MK12 370	370	1978	F/R	
		M	RC 248	248		F/R	
		FSB860	CASAL	M	50 CICLOMOTORI (diam.110)	50	
FSB861	CASAL	M	50 CICLOMOTORI (diam.140)	50		F/R	
FSB862	ITALJET	M	BAZOOKA 1 50	50	1991	R	
		M	BAZOOKA 2 50	50	1992	1997	R
		M	PISTA 2 50	50	1992	1996	R
		M	REPORTER 50	50	1990	1993	R
		M	SCOOP 50	50	1993		R
		M	YANKEE 8 50	50	1994		R
FSB863	BMW	M	R 100 1000 R	1000	1991	1995	R
		M	R 100 1000 RT	1000	1991	1995	R
		M	R 100 1000 R ROADSTER - MYSTIC	1000	1993	1996	R
FSB867	DERBI	M	AVENTURA 50	50	1996	R	
		M	BOX 50	50	1994	F/R	
		M	COPPA 50 FDT	50	1986	R	
		S	COPPA 50 FDX	50	1987	R	
		M	DS 50 WORLD CHAMPION	50	1988	R	
		M	FD 50 JUMBO	50	1985	R	
		M	FENIX 50	50	1994	R	
		M	FURAX 50	50	1996	R	
		M	FY 50 JUMBO	50	1984	R	
		M	URBAN 50	50	1994	F/R	
		M	VAMOS 50 R	50	1996	R	
		M	VARIANT 50 SPORT R	50	1994	R	
		S	TT8 75 (camme 10mm)	75		1983	F/R
		M	TT8 75	75	1984	R	
		M	YUMBO 75 RD-2 FDS	75	1987	R	
M	TT8 125 (camme 10 mm)	125		1983	F/R		
M	TT8 125	125	1984	F/R			
FSB869	PIAGGIO	M	VESPA 150 SPRINT VELOCE	150		F	
		M	VESPA 160 GS	160		F	
		M	VESPA 180 SS	180		F	
		M	VESPA 200 RALLY	200		F	
FSB870	GARELLI	M	TEAM MATIC 50	50	1988	F	
FSB871	MBK	M	EVASION 50 (ruote in lega oblique)	50		F/R	
		M	HARDROCK 50 (ruote in lega oblique)	50		F/R	
		M	MAGNUM 50 (ruote in lega oblique)	50		F/R	
		M	PASSION 50 (ruote in lega oblique)	50		F/R	
FSB872	PIAGGIO (motocari)	M	APE TM 220 P 602	220	1982	1983	F/R
		M	APE TM 220 P 703 / P 703 V / FL2	220	1984	2002	F/R
		M	APE TM 220	220	2009	2010	F/R
		M	APE TM 420 P703 / P703 V DIESEL	420	1987	2004	F/R
		M	APE TM 420 DIESEL LCS	420	2005	2010	F/R
		M	APE MP 420 601 CLASSIC	420	2006	2007	F/R
FSB873	PIAGGIO	M	VESPA 125	125	1963	1972	R
		M	VESPA 150	150	1963	1972	R
FSB874	LML	S	Star Deluxe 125 (2T/Disc model)	125	2001	2003	R
		S	Star 125 (2T) All Models	125	2010	2014	R
		S	Star 125i (4T) All Models	125	2010		R
		S	Star Deluxe 150 (2T/Disc model)	150	2001	2003	R
		S	Star 150 (2T) All Models	150	2010	2014	R
		S	Star 150 (4T) All Models	150	2010	2014	R
		S	Star 151i (4T) All Models	151	2010		R
		M	VESPA 50 PK XL 2	50			F/R
		M	VESPA 50 PK XL 2 AUTOMATICA	50			F
		M	VESPA 50 PK SPECIAL - XL	50	1986	1989	R
		M	VESPA 50 V FL 2	50	1990	1996	F/R
		M	VESPA 50 HP	50	1992	1996	F/R
		M	VESPA 80 PX (Spain)	80			R
		M	VESPA 80 (Spain)	80			R
		M	VESPA 80 SPECIAL (Spain)	80			R
		M	VESPA 125 PK XL 2	125			F/R
		M	VESPA 125 PX	125	1978	1982	F/R
		M	VESPA 125 PX ARCOBALENO	125	1981	1997	F/R
		M	VESPA 125 PK AUTOMATICA	125	1984		F
		M	VESPA 125 PK SPECIAL - XL	125	1986		F/R
		M	VESPA 125 V FL2	125	1991	1997	F/R
M	VESPA 125 PX	125	1998	2013	R		
M	VESPA 150 SPRINT VELOCE	150			R		
M	VESPA 150 PX (Spain)	150			F/R		
M	VESPA 150 PX	150	1978	1982	F/R		



			CC	FROM	TO	FRONT / REAR		
FSB875	PIAGGIO	M	VESPA 150 PX ARCOBALENO	150	1983	1990	F/R	
		M	VESPA 150 PX	150	1998		R	
		M	VESPA 160 GS	160			R	
		M	VESPA 180 SS	180			R	
		M	VESPA 200 RALLY	200			R	
		M	VESPA 200 PX E	200	1978		F/R	
		M	VESPA 200 PE	200	1983		F/R	
		M	VESPA 200 PX ARCOBALENO	200	1983		F/R	
		M	VESPA 200 PX	200	1998		R	
		M	VESPA 125	125	1951	1962	R	
		M	VESPA 150	150	1951	1962	R	
FSB876	APRILIA	M	ETX 125	125	1984		R	
		M	RED ROSE 125	125	1989	1989	R	
		M	RED ROSE 125	125	1990		R	
		M	ST 125	125	1987		R	
		M	STX 125	125	1984		R	
		M	STX 125	125	1986		R	
		BETA	M	CUSTOM 125	125	1982		R
		M	125 SCRAMBLER	125	1982		R	
		M	CUSTOM 250	250	1982		R	
		DUCATI	M	250 DESMO	250		1977	R
		M	350 DESMO	350		1977	R	
		FANTIC	M	SPORT 125	125		1984	R
		M	SPORT 125 MK II	125		1984	R	
		GARELLI	M	STRADA 125 (FM. 4000-A)	125	1983		R
		S	TSR 125	125			R	
		GILERA	M	TSR 125 SELF MIX	125		R	
		M	RV 125	125	1983		R	
		M	RV 125 ES	125	1987		R	
		M	TG1 125	125			R	
		M	TG2 125	125			R	
		M	TG3 125	125			R	
		M	T4 200	200			R	
		M	T4C 200	200			R	
		M	T4S 200	200			R	
		LAVERDA	M	125	125		1982	R
		M	125 (Brembo caliper)	125	1982		R	
		M	125 (Grimeca caliper)	125	1982		R	
		M	LB 125 UNO	125			R	
		M	LB 125 STRADA	125			R	
		M	LB 125 CUSTOM	125			R	
		MOTO MORINI	M	BICILINDRO 250	250	1979		R
		M	MONOCILINDRO 250	250		1981	R	
M	GT 350	350	1979		R			
M	GT 350 TURISMO	350	1980		R			
M	SPORT 350	350	1980		R			
PUCH	M	F5 250 REGOLARITA'	250	1983		R		
M	HFE 250	250	1986	1986	R			
M	MC 250 VHS W	250	1983		R			
M	FS 347 REGOLARITA'	347		1983	R			
M	MC 496	496		1983	R			
FSB877	BENELLI	M	CITY BIKE 50	50		F/R		
		M	S 50 LUSSO	50	1981	1987	F	
		M	S 50	50	1981	1987	F	
		M	S 50 (tutti i modelli)	50	1987		F	
		M	SCOOTY 50	50			F/R	
		FANTIC	M	ISSIMO 50 (alloy wheels)	50		F/R	
		M	ISSIMO 50	50	1984		F/R	
		GARELLI	M	BASIC 50 (alloy wheel fondermonte)	50		F/R	
		M	NOI 50 (alloy wheels fondermonte)	50			F/R	
		M	VIP 50 alloy wheels (fondermonte)	50			F/R	
		PUCH	M	MAXI 80 EXECUTIVE	80	1988		R
FSB878	PIAGGIO (motocari)	M	APE MP 220 P 501 (II SERIE)	220	1978	1996	F/R	
		M	APE CAR 220 P2/P3	220	1978	1985	F/R	
		M	APE MP 220 P 601 (II SERIE)	220	1978	1996	F/R	
		M	APE CAR 420 DIESEL	420	1986	1996	F/R	
		M	APE CAR 420 MAX DIESEL 9 q.li	420	1986	1996	F/R	
FSB879	PIAGGIO	M	VESPA 150 SUPER	150		R		
FSB880	MOTO GUZZI	M	V 7 700	700	1967	1976	F	
FSB881	MOTO GUZZI	M	V 7 700	700	1967	1976	R	
		M	V 7 700 SPECIAL	700	1969	1971	R	
FSB883	PGO	M	BIG MAX 50	50	1995	2004	R	
		M	BIG MAX 50 S	50	2003	2004	R	
		S	Big Max 50 (Front wave disc)	50	2007	2009	R	
		S	Big Max 50 Naked	50	2007	2009	R	
		M	COMET 50	50	1991		R	
		S	EPS	50	1997		R	
		S	G-Max 50	50	2005	2007	R	
		S	G-Max 50 (Wave disc)	50	2008	2012	R	
S	G-Max 50 Naked (Wave disc)	50	2009		R			



CC FROM TO FRONT / REAR

Code	Brand	Model	CC	FROM	TO	FRONT / REAR			
...FSB883		M GALAXI 50	50	1992		R			
		S Ligero 50 (2T)	50	2008	2012	R			
		S Mega 50	50	1994		R			
		M PMX 50	50	2000	2004	R			
		M PS 50	50	1993		R			
		S Rodo Show 50	50	2000	2009	R			
		M SUPER FIFTY 50 (BRASIL)	50			R			
		S Tornado 50	50	1997		R			
		M GALAXI 90	90	1992		R			
		M PMX 110	110	2000	2004	R			
		S Tornado 125	125	1997		R			
		SINNIS	S QM 50 10A (B) Hawk	50	2008	2010	R		
			S QM 50 T-10R Eagle 50	50	2010	2012	R		
		SUZUKI	M TR 50 STREET MAGIC	50	1998	2000	R		
			M ADDRESS 100 V	100	1992	1996	R		
		TGB	M UG 110 HOKUTO	110	2000	2004	R		
			S 101R (50cc)	50	2004	2009	R		
			S 202 Classic (50cc)	50	2003		R		
			S 302Sport (50cc)	50	2003	2009	R		
			S 303Revolution (50cc)	50	2002	2003	R		
			S 303RHawk/Laser (50cc)	50	2004		R		
			S 309RS 50	50	2002	2003	R		
			S F409Cruise 50/125	50	2002	2005	R		
			S AkrosTec -50	50	2003	2004	R		
			S Bullet 2 50 (2T)	50	2011	2012	R		
			S City50cc (2T)	50	2007	2008	R		
			S City50cc (4T)	50	2007	2011	R		
			S Delivery50 Scooter (Up to E/F no 609099)	50	2004	2006	R		
			S Delivery/Express50 (From F/E No 609100)	50	2006	2012	R		
			S HighWheel 50	50	2002	2003	R		
			S TapoRR 50 (2T)	50	2010	2012	R		
			S TapoRS 50 (2T)	50	2010	2012	R		
			S Trigger50	50	2002	2003	R		
			S XRace 50 (2T)	50	2011	2012	R		
			S 303Revolution (125cc)	125	2002	2003	R		
			S 304Sport (125cc)	125	2003	2009	R		
			S F409Cruise 125	125	2002	2005	R		
			FSB885	PIAGGIO	M VESPA 50	50	1963		R
			FSB886	PIAGGIO (motocarr)	M APE 50 P	50	1980	1985	R
				M APE 50 TM P	50	1985	1989	R	
				M APE 50 FL/FL2	50	1989	1995	R	
				M APE 50 FL3 EUROPA	50	1996	1999	R	
				M APE 50 RST MIX	50	1999	2005	R	
				M APE 50 EURO 2	50	2003	2010	R	
		FSB887	FANTIC	M TRIAL 50 JUNIOR	50	1987		R	
	PIAGGIO	M VESPA 50 PK XL 2 AUTOMATICA	50			R			
		M VESPA 125 PK AUTOMATICA	125	1984		R			
FSB888	PIAGGIO	M SUPERBRAVO 50 3 Marce	50	1987		R			
FSB889	GILERA	M CB 1 50	50			R			
		M CBA 50	50			R			
		M CBA 50	50	1986		R			
		M ECO 50	50			R			
		M TREND 50	50	1989	1992	R			
	ITALJET	M SHOPPING 50	50	1990		R			
	PIAGGIO	M BOSS 50	50	1988		R			
		M BOXER 50	50			R			
		M BRAVO 50	50			R			
		M BRAVO 50 (alloy wheels)	50	1987		R			
		M BRAVO 50 (alloy wheels 90mm hub)	50	1987		R			
		M CIAO 50	50			R			
		M CIAO 50 (alloy wheels)	50	1987		R			
		M CIAO 50 MIX	50	1997		R			
		M GRILLO 50	50	1989		R			
		M SI 50	50			R			
		M SI 50 (alloy wheels)	50	1980		R			
		M SI 50 MIX	50	1997		R			
		M SUPER BRAVO 50	50	1985		R			
FSB890	PIAGGIO	M VESPA 50 SPECIAL	50			F			
		M VESPA 50	50	1963		F			
		M VESPA 50 PK SPECIAL - XL	50	1986	1989	F			
		M VESPA 80 PX (Spain)	80			F			
		M VESPA 80 (Spain)	80			F			
		M VESPA 80 SPECIAL (Spain)	80			F			
		M VESPA 90 PRIMAVERA	90	1958		F			
		M VESPA 125 ET3	125			F			
		M VESPA 125	125	1951	1962	F			
		M VESPA 125	125	1963	1972	F			
		M VESPA 125 PRIMAVERA	125	1967	1983	F			
		M VESPA 150 SUPER	150			F			
		M VESPA 150	150	1951	1962	F			



CC FROM TO FRONT / REAR

Code	Brand	Model	CC	FROM	TO	FRONT / REAR		
	PIAGGIO (motocarr)	M VESPA 150	150	1963	1972	F		
		M APE 50 P	50	1980	1985	F		
		M APE 50 TM P	50	1985	1989	F		
		M APE 50 FL/FL2	50	1989	1995	F		
		M APE 50 FL3 EUROPA	50	1996	1999	F		
		M APE 50 RST MIX	50	1999	2005	F		
		M APE 50 EURO 2	50	2003	2010	F		
		M APE 150 C4	150			F		
		M APE 150 C 1/2/3	150			F		
		M APE 175 PENTARO'	175			F		
		FSB891	PIAGGIO	M VESPA 50 SPECIAL	50			R
				M VESPA 90 PRIMAVERA	90	1958		R
				M VESPA 125 ET3	125			R
				M VESPA 125 PRIMAVERA	125	1967	1983	R
		FSB892	PIAGGIO	M COSA 125	125	1989	1991	R
		M COSA 2 125	125	1992	1997	R		
		M COSA 150	150	1989	1991	R		
		M COSA 2 150	150	1992	1997	R		
		M COSA 200	200	1989		R		
		M COSA 2 200	200	1992		R		
FSB893	PIAGGIO	M COSA 125	125	1989	1991	F		
		M COSA 2 125	125	1992	1997	F		
		M COSA 150	150	1989	1991	F		
		M COSA 2 150	150	1992	1997	F		
		M COSA 200	200	1989		F		
		M COSA 2 200	200	1992		F		
FSB894	PIAGGIO	M SFERA 50	50	1991	1994	F		
		M SFERA 80	80	1994	1996	F		
FSB895	GILERA	S EASY MOVING 50	50	1995	1996	R		
		M NRG 50	50	1995	2003	R		
		M STORM 50	50	1994	1995	R		
		M TYPHOON 50	50	1993	1995	R		
		M TYPHOON 80	80	1995		R		
	PIAGGIO	M FREE 50 (alloy wheels)	50	1996	2000	R		
		M NRG 50	50	1994	1995	R		
		M NTT 50	50		1995	R		
		M QUARTZ 50	50	1992	1996	R		
		M SFERA 50	50	1991	1994	R		
		M ZIP 50	50	1992	1996	R		
		M SFERA 80	80	1994	1996	R		
		M SKIPPER 80	80	1994	1996	R		
FSB896	PIAGGIO	M SCATTO 50	50	1990	1993	F/R		
		M ZUM 50	50	1991	1996	F/R		
FSB897	BETA	M MX6 50 EXPORT	50	1977		F/R		
		M TR 50	50	1980	1986	R		
		M TR 80	80	1980		R		
		M CR 125	125		1981	F		
		M RC 125	125	1976		F		
	FANTIC	M CABALLERO 50 REG. SUPER 6 M	50		1983	F/R		
		M ENDURO 50	50	1983		F/R		
		M R 6 50 SUPER	50			F/R		
		M TRIAL 50 I SERIE (mozzi centrali)	50		1983	R		
		M TRIAL 80	80		1983	F/R		
		M TRIAL 125 7 DAYS(mozzi centrali)	125			F		
		M TRIAL 125 II SERIE (tel.rosso m.cen)	125			F/R		
		M TRIAL 125 I SERIE. (tEL. grig. m. cen)	125			R		
	GILERA	M GIUBILEO 98	98			R		
		M GIUBILEO 124	124			R		
		M ARCORE 125	125			R		
	MALAGUTI	M MDX GOLD 50 ENDURO	50	1987		R		
		M MEX 50 ENDURO	50	1985		R		
		M MEX 50 ENDURO	50	1986		R		
		M MGX 50 ENDURO	50	1987		F/R		
		M MLX 50 ENDURO	50	1987		R		
		M RGT 50 SPORT	50	1985		R		
	MOTO GUZZI	M TURISMO 125	125	1974	1981	R		
		M TUTTOTERRENO 125	125	1974	1981	F/R		
FSB898	ACCOSSATO	M CR 50 ENDURO COMPETIZIONE	50	1984		F/R		
		M CR 50 CROSS COMPETIZIONE	50	1984		F/R		
		M CR 50 ENDURO	50	1984		F/R		
		M 50 CROSS	50	1983		F/R		
		M CE 80 ENDURO H 20	80	1984		R		
		M CE 80 CROSS H 20	80	1984		R		
		M 80 CROSS	80	1983		F/R		
		M CE 125 CROSS H 20	125	1984		R		
		M CE 125 ENDURO H 20	125	1984		R		
	ANCILLOTTI	M PS 80 MX	80	1983		F/R		
		M PST 125 MX	125	1983		F/R		
		M PSV 250 MX	250	1983		F		
	APRILIA	M MX 50	50	1976	1982	F/R		

M = MOTORCYCLE
S = SCOOTER
A = ATV
Sn = SNOWMOBILE



CC FROM TO FRONT / REAR

...FSB898

CC	FROM	TO	FRONT / REAR
M	RC 50 SPECIAL	50	1983 F/R
M	MX 125	125	1977 1985 F
M	RX 125 (Rimoldi wheels)	125	1984 1985 F
M	TX 125	125	1985 F/R
M	TX 125 M	125	1986 R
M	TX 240	240	1985 F/R
M	TX 300	300	1985 F/R
M	TX 300	300	1986 R
M	TX 300 M	300	1986 R
M	TX 311 M	312	1987 R
M	TRIAL 320	320	1981 F/R
ASPES	M CS 75 NAVAHO	50	1967 1982 F
M	CM1 80	80	1967 1982 F/R
M	HOP1 125	125	1972 1982 F
M	JUMA 125	125	1975 1979 F
BETA	M MX6 50	50	1982 F/R
M	TR 50	50	1987 1988 F/R
M	TR 50 (SPAIN)	50	1989 R
M	RX 125	125	1983 R
M	TR 125	125	1980 1985 F/R
M	TR 32 125	125	1986 R
M	TR 33 125	125	1987 R
M	TR 240	240	1980 1983 F/R
M	TR 32 240 (mozzo ant autocentrante)	240	1984 1985 R
M	TR 32 240	240	1984 1985 F/R
M	TR 33 240	240	1986 1988 R
M	TREKKING 240	240	1987 F/R
CAGIVA	M SXT 125	125	1982 R
M	WMX 125	125	1982 F/R
M	WMX 125 /3	125	1983 F/R
M	WMX 125 (mozzi Rimoldi)	125	1984 R
M	WRX 125	125	1982 F/R
M	WRX 125 /1	125	1983 F/R
M	XRX 125	125	1980 F/R
M	XWMX 125	125	1981 F/R
M	WMX 250	250	1982 R
M	WMX 250 /1	250	1983 R
M	WRX 250	250	1983 F/R
M	WRX 250	250	1983 R
FANTIC	M CASA 50	50	1975 F/R
M	COMPETIZIONE 50	50	1975 F/R
M	ENDURO 50 COMPETITION	50	1982 F/R
M	ENDURO 50 REPLICA	50	1980 F/R
M	FAST 50	50	1988 R
M	GRAN TURISMO 50 FOUR (FM. 200)	50	1982 F/R
M	REPLICA 50	50	1980 F/R
M	STRADA 50 SUPER SIX	50	1973 R
M	STRADA 50 (FM. 240)	50	1982 R
M	CROSS 80 COMPETITION	80	1981 F/R
M	CROSS 80 COMPETITION	80	1981 F
M	ENDURO 80	80	1980 F
M	CROSS 125 COMPETITION	125	1980 F
M	ENDURO 125	125	1980 F
M	REGOLARITA' 125	125	1981 F
M	TRIAL 125 7 DAYS mozzi conici	125	F/R
M	TRIAL 125 III SERIE (mozzi conici)	125	F/R
M	TRIAL 125 PROFESSIONAL (FM.237)	125	1983 F/R
M	TRIAL 125 .1 Progress 2	125	1986 R
M	TRIAL 125 .1 Progress 1	125	1986 1986 R
M	TRIAL 200 Progress 1	200	1986 R
M	TRIAL 201 Progress2	201	1986 R
M	TRIAL 240 SEVEN DAYS (FM. 289)	240	1986 R
M	TRIAL 241 PROFESSIONAL	241	1986 R
M	COACH 250	250	1991 R
M	TRIAL 300 (FM. 403)	300	1984 R
M	TRIAL 301 Progress 1 (FM. 266)	301	1985 R
M	TRIAL 301 Progress 2	301	1986 R
M	TRIAL 200 (FM. 350)	350	1978 F/R
M	TRIAL 240 (FM. 450)	450	1983 F/R
GARELLI	M TRIAL 320	320	1985 F/R
M	TRIAL 320	320	1986 R
GILERA	M E1 125 COMPETIZIONE	125	F
M	E1 125	125	F
MALANCA	M MARK 125	125	1985 R
PUCH	M GS 80 V	80	1983 F/R
M	FS 125 REGOLARITA'	125	1983 F/R
M	F5 250	250	1984 F
SWM	M GS 50 RBS ENDURO	50	1983 F/R
M	MC 50 CROSS	50	1983 F/R
M	MK 50	50	1983 F/R



CC FROM TO FRONT / REAR

FSB901

CC	FROM	TO	FRONT / REAR
M	GS 80 RBS ENDURO	80	1983 F/R
M	MC 80 CROSS	80	1983 F/R
M	MK 80	80	1983 F/R
M	HW 125	125	1983 F/R
M	MW 125 TRIAL	125	1983 F/R
M	TL 125	125	1983 F/R
M	HW 240	240	1983 F/R
M	MW 240 TRIAL	240	1983 F/R
M	TL 240	240	1983 F/R
M	TRIAL 240	240	1983 F/R
M	HW 320	320	1983 F/R
M	MW 320 TRIAL	320	1983 F/R
M	TL 320	320	1983 F/R
M	TRIAL 320	320	1983 F/R
M	HW 350	350	1983 F/R
M	MW 350 TRIAL	350	1983 F/R
M	TL 350	350	1983 F/R
FSB901	ANCILLOTTI	M PSV 250 MX	250 1983 R
	APRILIA	M MX 125	125 1977 1985 R
		M MX 250	250 1980 1982 F/R
		M MX 250	250 1983 1983 R
		M RX 250	250 1983 1983 F/R
	ASPES	M CS 75 NAVAHO	50 1967 1982 R
		M DUMA 125	125 1972 1982 R
		M HOP1 125	125 1975 1979 R
	BETA	M 125 6V	125 1974 F/R
		M CR 125	125 1981 R
		M CR 125	125 1982 F/R
		M RC 125	125 1976 R
		M RC 125 EXPORT ASPIRATO	125 1980 F/R
		M RC 125 (liquid cooled)	125 1981 F/R
		M 125 SCRAMBLER	125 1982 F
		M CR 250	250 1983 R
		M CR - RV 250	250 1981 F
		M GS - RV 250	250 1980 F/R
		M CR - RV 350	350 1980 F
		M GS -RV 350	350 1980 F
	CAGIVA	M ALETTA 125 ELECTRA	125 1988 R
		M SST 125	125 1981 R
		M XSST 125 ruota integrale	125 1978 R
		M MXR 250	250 1981 F/R
		M RX 250	250 1981 F/R
		M MXR 400	400 1981 F/R
		M MXR 500	500 1981 F/R
	FANTIC	M CROSS 80 COMPETITION	80 1981 R
		M ENDURO 80	80 1980 R
		M CROSS 125 COMPETITION	125 1980 R
		M ENDURO 125	125 1980 R
		M REGOLARITA' 125	125 1981 R
	GILERA	M TG1 80	80 1980 R
		M TG2 80	80 1980 R
		M TG3 80	80 1980 R
		M ARCORE 125	125 1981 F
		M E1 125 COMPETIZIONE	125 1981 R
		M E1 125	125 1981 R
		M GR1 125	125 1981 R
		M ARCORE 150	150 1981 R
	KRAMER	M 250	250 1981 R
	MOTO MORINI	M KANGURO 350	350 1983 F
		M CAMEL 500	500 1983 F
		M CAMEL 500	500 1984 R
	PUCH	M F5 250 REGOLARITA'	250 1983 F
		M MC 250 VHS W	250 1983 F
		M CROSS 347	347 1981 F
		M FS 347 REGOLARITA'	347 1983 F
		M MC 496	496 1983 F
	SWM	M CROSS 125	125 1983 F/R
		M ENDURO 125	125 1983 F/R
		M ENDURO 175	175 1983 F/R
		M CROSS 250	250 1983 F/R
		M ENDURO 347	347 1983 F/R
		M CROSS 440	440 1983 F/R
		M ENDURO 440	440 1983 F/R
FSB902	BENELLI	M BOBO 50	50 1978 F/R
		M EXPORT 3 V 50	50 1979 F/R
		M G 2 50	50 1979 F/R
		M MOTORELLA 50	50 1979 F/R
	BETA	M ANDY 50 alloy wheels	50 1978 F/R
		M ANDY 50 spoke wheels	50 1978 F/R

6016

FERODO
RACING
Updated on November 2020

M = MOTORCYCLE
S = SCOOTER
A = ATV
Sn = SNOWMOBILE

FRONT
/ REAR

...FSB902

	CC	FROM	TO	FRONT / REAR
M	B12 50	50	1973	F/R
M	MIO 50	50	1979	F/R
FANTIC	M	ISSIMO 50 (spoke wheels)	50	F/R
GARELLI	M	BASIC 50 (spoke wheel)	50	F/R
M	EUREKA 50	50		F/R
M	GULP 50	50		F/R
M	NOI 50 MATIC	50		F/R
M	NOI 50 (spoke wheel)	50		F/R
M	SUPER VIP 50	50		F/R
M	VIP 50 (spoke wheel)	50		F/R
GILERA	M	CB 1 50	50	F
M	CBA 50	50		F
M	CBA 50	50	1986	F
M	ECO 50	50		F
MALAGUTI	M	CHOPPER 25	25	1982 R
M	CHOPPER 40	40	1982	R
M	LX 50 SPORT	50	1982	R
M	Mopeds 50 (all models)	50	1983	R
M	RCW 50 RONCO	50	1982	R
M	VA 50 OLYMPIQUE	50	1982	R
M	CHOPPER 80	80	1982	R
MOTO GUZZI	M	CHIU' 50	50	1974 1976 F/R
M	DINGO 50 3M	50	1966 1974	F/R
M	DINGO 50 M	50	1969 1973	F/R
M	DINGO 50 3 V	50	1975 1976	F/R
M	DINGO 50 MM	50	1975 1976	F/R
M	MAGNUM 50	50	1975 1976	F/R
M	TROTTER 50	50	1966 1970	F/R
M	TROTTER 50 SUPER	50	1966 1970	F/R
M	TROTTER 50 MARK M - V	50	1971 1973	F/R
M	TROTTER 50 SPECIAL M - V	50	1971 1973	F/R
PIAGGIO	M	BOXER 50	50	F
M	BRAVO 50	50		F
M	CIAO 50	50		F
M	FREE 50	50	1993 1995	F
M	SI 50	50		F
M	SUPER BRAVO 50	50	1985	F
M	VESPINO 50 (Spain)	50		1979 F
RIZZATO	M	ATALA UNO 50 (spoke wheels)	50	F/R
TOMOS	M	K 83	83	F/R
M	M 83	83		F/R
FSB904	ACCOSSATO	M	CE 80 ENDURO H 20	80 1984 F
M	CE 80 CROSS H 20	80 1984 F		
M	CE 125 CROSS H 20	125 1984 F		
M	CE 125 ENDURO H 20	125 1984 F		
APRILIA	M	TUAREG 125	125 1984 F	
M	MX 250	250 1984 1985	F/R	
M	RX 250	250 1984	F/R	
TRE SOLDI	M	REGOLARITA' 80	80 1986 1986	R
FSB905	BETA	M	TR 33 TREKKING 240	240 1988 R
FSB906	GARELLI	M	FORMUNO 50 (from frame N. 2701552)	50 1987 F
PEUGEOT	M	FOX 50	50 1996	F
FSB907	ACCOSSATO	M	50 CROSS MINI	50 1982 F/R
APRILIA	M	ET 50	50 1984 1986	F
M	RC 50	50 1983	1983 F/R	
M	RED ROSE 50	50 1988	1991 R	
M	TUAREG 50	50 1984	1986 F	
ASPES	M	CS 50 NAVAHO	50 1970 1981	F/R
BETA	M	FOUR 50 S	50 1987	R
M	FOUR 50 AE	50 1987		R
M	FOUR TWIN 50	50 1988		R
M	M4 50	50 1983		R
M	M6 50	50 1983		R
M	MS 50	50 1980		R
M	MX4 50 Special	50 1970		F/R
M	SCRAMBLER 50 4 M	50 1982		F/R
M	SQUIRREL 50	50 1983		R
M	TR 50	50 1980 1986		F
M	TR 80	80 1980		F
FANTIC	M	TRIAL 50 I SERIE (mozzi centrali)	50 1983	F
M	TRIAL 125 I SERIE. (tEL. grig. m. cen)	125		F
GARELLI	M	CICLONE 50 N/N DE LUXE SELF MIX L	50	F/R
M	CICLONE 50 I SERIE (spoke wheel)	50		F/R
M	CICLONE 50 II SERIE (alloy wheels)	50		F/R
M	CICLONE 50 N DE LUXE SELF MIX L.C	50		R
M	GRAN TURISMO 50 (alloy wheel)	50		F/R
M	KL 50 SV	50		F/R
MALAGUTI	M	CENTRO 50	50 1992	F
M	FIFTY 50 HF	50 1982		R
M	FIFTY 50 FULL (all models)	50 1983		R

FRONT
/ REAR

	CC	FROM	TO	FRONT / REAR
M	FIFTY 50 TOP	50	1985	R
M	FIFTY 50 HF	50	1987	F/R
M	FIFTY 50 NL	50	1987	F/R
M	FIFTY 50 4 MARCE	50	1987	F/R
M	WC 50 WATERCOOLED	50	1982	R
MOTO GUZZI	M	DINGO 50 GT	50 1966 1974	F/R
M	DINGO 50 CROSS	50 1966 1974		F/R
M	DINGO 50 TURISMO	50 1966 1974		F/R
M	DINGO 50 SUPER	50 1966 1974		F/R
M	DINGO 50 SPORT	50 1966 1974		F/R
RIZZATO	M	ATALA CALIFFONE 50 (alloy wheels)	50	F/R
M	ATALA MASTER 50 (alloy wheels)	50		F/R
SWM	M	TR 50	50 1983	F/R
M	TL 50 TRIAL	50	1983	F/R
M	TR 80	80	1983	F/R
M	TL 80 TRIAL	80	1983	F/R
FSB908	BENELLI	M	G 2 50 ELLE	50 1979 F/R
GARELLI	M	BASIC 50 (alloy wheels grimeca)	50	F/R
M	FORMUNO 50 (up to frame N. 2701551)	50 1987		R
M	FORMUNO 50 (from frame N. 2701552)	50 1987		R
M	FORMUNO 50 F1 RAID	50 1987		R
M	NOI 50 (alloy wheels grimeca)	50		F/R
M	TEAM MATIC 50	50 1988		R
MALAGUTI	M	VIP 50 (alloy wheels grimeca)	50	F/R
M	DRIBBLING 50 (all models)	50 1987		F/R
M	FIFTY 50 RV	50 1987		F/R
M	FIFTY 50 RV VARIATORE / KICK	50 1987		F/R
M	FOX 50 CUSTOM	50 1988		F/R
M	GRIZZLY 50 (all models)	50 1987		F/R
M	GRIZZLY 50 RCX / "12"	50 1987		R
M	RANOCCHIO 50 3 RUOTE	50 1988		F/R
M	RGT 50 STRADA	50 1983		R
PIAGGIO	M	BOSS 50	50 1988	F
M	BRAVO 50 (alloy wheels 90mm hub)	50 1987		F
PUCH	M	MAXI 80 EXECUTIVE	80 1988	F
FSB909	APRILIA	M	ETX 125	125 1985 1986 R
M	ETX 125	125 1986 1997		R
M	RX 125	125 1985 1989		R
M	TUAREG 125	125 1984		R
M	TUAREG 125 RALLY	125 1986		R
M	RX 250	250 1986		R
M	TUAREG 250 RALLY	250 1986		R
FSB910	BETA	M	PULMAN 50	50 1970 F/R
FANTIC	M	SPRINTER 50 3V. R (FM. 248)	50 1983	F/R
M	SPRINTER 50	50 1984		F/R
GARELLI	M	JUNIOR 50 TURISMO (spoke wheel)	50	F/R
GILERA	M	TREND 50	50 1989 1992	F
ITALJET	M	SHOPPING 50	50 1990	F
PIAGGIO	M	BRAVO 50 (alloy wheels)	50 1987	F
M	CIAO 50 (alloy wheels)	50 1987		F
M	GRILLO 50	50 1989		F
M	SI 50 (alloy wheels)	50 1980		F
M	SUPERBRAVO 50 3 Marce	50 1987		F
M	VESPINO 50 (Spain)	50 1980		F
RIZZATO	M	ATALA CALIFFONE 50 (spoke wheels)	50	F/R
FSB911	APRILIA	M	TUAREG 250	250 1984 R
GARELLI	M	TIGER 125 XR	125	R
M	TIGER 125 XRD	125		R
GILERA	M	HX 125 LC	125 1983	R
MOTO GUZZI	M	TT 125	125 1985	R
TRE SOLDI	M	REGOLARITA' 80	80 1986 1986	F
FSB912	PIAGGIO	M	VESPINO 50 (Spain)	50 1979 R
M	VESPINO 50 (Spain)	50 1980		R
FSB913	YAMAHA	M	XT 125	125 1976 F
M	YZ 125 C - D - E - F - G - H - J	125 1976 1982		F
M	IT 175 G - H - I	175 1980 1982		F
M	IT 250 G	250 1980		F
M	IT 250 H - J - K	250 1981 1983		F
M	TY 250 H	250 1981 1983		F
M	XL 250 G	250 1980		F
M	YZ 250 D - E - F	250 1976 1979		F
M	YZ 250 G	250 1980		F
M	YZ 250 H	250 1981		F
M	YZ 400 D - E - F	400 1977 1979		F
M	IT 425 G	425 1980		F
M	IT 500 G - H	500 1980 1981		F
M	TT 500 G - H	500 1976 1981		F
FSB914	ITALJET	M	BAZOOKA 1 50	50 1991 F
M	REPORTER 50	50 1990 1993		F
RAPIDO	M	SCRENNA 50	50	F

M = MOTORCYCLE
S = SCOOTER
A = ATV
Sn = SNOWMOBILE



				CC	FROM	TO	FRONT / REAR
FSB915	PIAGGIO	M	FREE 50	50	1993	1995	R
		M	FREE 50 (alloy wheels)	50	1996	2000	F
		M	ZIP 50	50	1992	1996	F
FSB916	BSA	M	BANTAM D7 175	175			F/R
	TRIUMPH	M	CUB 500	500			F/R
FSB917	BSA	M	BANTAM D1 125	125			F/R
FSB918	BSA	M	C15 250	250			F/R
FSB919	TRIUMPH	M	T 100	100	1970		F
		M	T 120	120	1966		F
		M	T 140	140	1970		F
		M	T 150	150	1969		F
FSB920	NORTON	M	COMMANDO	750	1968	1973	F
FSB921	TRIUMPH	M	T 100	100	1970		R
		M	T 120	120	1966		R
		M	T 140	140	1970		R
		M	T 150	150	1969		R
		M	TIGER 750 TR 7V	750		1975	
FSB922	NORTON	M	COMMANDO	750	1968	1973	R
FSB923	NORTON	M	adaptable to front 200x30 drums				F
FSB924	BSA	M	A 7 - A 10 125	125			R
FSB925	HONDA	M	FL 400 R PILOT (4W)	400	1989	1990	F
		A	HONDA ATV TRX 200 Fourtrax	200	1984	1985	F
		A	TRX 250 Fourtrax	250	1985	1987	F
		A	FL 350 R ODYSSEY	350	1985	1990	F
		A	FL 400 R Pilot	400	1989	1990	F
FSB928	YAMAHA ATV	A	YFM 350 ERT/ERU	350	1987	1988	F
		A	YFM 350 FW T/U	350	1987	1988	F
		A	YFM 350 FW T/U BIG BEAR	350	1987	1988	F
FSB929	SUZUKI ATV	A	LT-F 300 KING QUAD	300	1991	2001	F
		A	LT-F 400 X	400	1991	2000	F
FSB931	HONDA ATV	A	TRX 300 (4WD) FW Fourtrax	300	1988	2000	F
		A	TRX 350 TM/TE/FE/FM Fourtrax Rancher	350	2000	2007	F
		A	TRX 400 Fourtrax Rancher	400	2004	2007	F
		A	TRX 450 FE/FM Fourtrax Foreman ES / S	450	1998	2004	F
		A	TRX 500 FGA Fourtrax Foreman Rubicon Gpscape	500	2001	2005	F
		A	TRX 500 FA Fourtrax Rubicon	500	2001	2004	F
FSB932	KAWASAKI ATV	A	KLF 300 BAYOU A Series	300	1986	1987	F
		A	YFM 350 FW W/A/B/D/E/F/G BIG BEAR	350	1989	1995	F
FSB933	YAMAHA ATV	A	YFM 350 FW E/F/G	350	1993	1995	F
		A	YFM 350 FW H/J/K BIG BEAR	350	1996	1998	F
		A	YFM 400 FW KODIAK	400	1993	1998	F
		M	adaptable to front 85x20 drums				
FSB936	CZ	M	adaptable to front 85x20 drums				F
FSB937	PIAGGIO	M	P1 50	50	1994		F/R
	PUCH	M	RADICAL 50	50	1994		F/R
FSB938	APRILIA GILERA PIAGGIO	M	MOJITO CUSTOM 50	50	2004	2012	R
		M	RUNNER 50	50	1997	1998	R
		M	TYPHOON 125	125	1995		R
		M	TYPHOON 125 XR KAT	125	2000		R
		M	FREE 50	50	2002		R
		M	NRG 50 POWER DT	50	2005	2007	R
		M	NRG 50 MC2	50	1998		R
		M	NRG 50 EXTREME (Rear drum model)	50	1999	2001	R
		M	NRG 50 DT MC3 (Rear drum model)	50	2001	2005	R
		M	NRG 50 Power DT	50	2005	2013	R
		M	TYPHOON XR 50	50	2000	2007	R
		M	VELOFAX 50	50	1996		F
		M	VESPA 50 ET2	50	1997	1998	R
		M	VESPA 50 ET4	50	1999		R
		M	VESPA LX 50 2T	50	2005		R
		M	VESPA LX 50 4T	50	2005		R
		S	VESPA S 50 (2T)	50	2007	2013	R
		S	Vespa LXV 50	50	2007	2009	R
		S	VESPA S 50 (4T/4V)	50	2008	2013	R
		M	VESPA LX 50 2T TOURING	50	2010		R
		M	VESPA LX 50 4T TOURING	50	2010		R
		S	VESPA S 50 Sport (2T)	50	2011	2013	R
		S	VESPA S 50 Sport (4T/4V)	50	2011	2013	R
		S	VESPA SPRINT 50 (2T 2V)	50	2014		R
		S	VESPA SPRINT 50 (4T 4V)	50	2014		R
		S	VESPA SPRINT 125 (4T 3V) i.e. ABS	50	2014		R
		M	XR 50	50	2000		R
		M	ZIP 50 BASE (Disc)	50	1995	1996	R
		M	ZIP 50 SP	50	1996	2000	R
		M	ZIP 50 RST	50	1996	1997	R
		M	ZIP 50	50	1999		R
		M	ZIP 50 Grimeca/Heng Tong A/C 4T	50	2000	2008	R
		M	ZIP 50 SP	50	2001	2006	R
		S	Zip 100	100	2007		R
		M	HEXAGON 125	125	1994	1997	R



				CC	FROM	TO	FRONT / REAR
FSB939	APRILIA	M	SFERA 125	125	1995	1997	R
		M	SFERA 125 (4 stroke)	125	1996		R
		M	SKIPPER 125	125	1993	1997	R
		M	TYPHOON 125 / XR 125	125	1995	2000	R
		M	VESPA 125 ET4	125	1996		R
		M	VESPA LXV 125 / LX 125 / LXW 125 / Touring	125	2005	2013	R
		S	Vespa S 125 (4T)	125	2007	2013	R
		S	Vespa S 125 Sport (4T)	125	2011	2013	R
		M	ZIP 125	125	2000		R
		M	HEXAGON 150	150	1994	1999	R
		M	SKIPPER 150	150	1993	1997	R
		M	VESPA 150 ET4	150	1996		R
		FSB940	PIAGGIO	S	VESPA LX 150	150	2005
S	VESPA S 150 (4T)			150	2007	2013	R
S	VESPA S 150 Sport (4T)			150	2011	2012	R
S	VESPA LX 150 (Serie Speciali/4T)			150	2012		R
S	SCARABEO 50			50	1994	1995	F
M	TYPHOON 50			50	1996		R
M	FREE 50			50	1996	2000	R
M	FREE Delivery 50			50	2000	2001	R
M	NRG 50			50	1996	1997	R
M	NRG 50 MC2			50	1996	1997	R
M	NTT 50			50	1996		R
M	SFERA 50 RST			50	1995	1997	R
M	TYPHOON 50			50	1993	1999	R
M	ZIP 50 FAST RIDER	50	1993	1997	R		
M	ZIP 50 Electric	50	2002		R		
M	TYPHOON 80	80	1993	1996	R		
FSB941	MALAGUTI	M	CR1 50 CROSSER	50	1995		R
		M	CR1 50 CROSSER	50	1996		R
FSB942	HONDA	M	XL 250 K3 - K4	250	1978	1979	F
FSB943	HONDA	M	CB 250	250	1973	1975	F
		M	CB 350 K4	350			F
		M	CB 360 G5 all models	360	1975		F
FSB945	HONDA ATV	A	TRX 200 (4WD)	200	1990		F
		A	TRX 200 Fourtrax	200	1986	1998	F
		A	TRX 250 TM2 Re Con	250	1997	2014	F
		A	TRX 250 TE2 Re Con ES	250	2002	2014	F
		A	TRX 300 (2WD) Fourtrax	300	1988	2000	F
		S	FES 125 PANTHEON	125	1998	1999	R
FSB946	HONDA	S	FES 125 PANTHEON	125	2000	2006	R
		S	FES 150 PANTHEON	150	1998	1999	R
		S	FES 150 PANTHEON	150	2000	2002	R
		S	FES 250 FORESIGHT	250	1997	1998	R
		A	TRX 350 TM/TE/FE/FM Fourtrax Rancher	350	2000	2007	R
		A	TRX 400 FW / FM Fourtrax Foreman	400	1995	2003	R
		A	TRX 400 Fourtrax Rancher	400	2004	2007	R
		A	TRX 420 TM/TE/FE/FM Fourtrax Rancher	420	2007	2010	R
		A	TRX 420 FPE/FPM Fourtrax Rancher 4x4	420	2009	2010	R
		A	TRX 450 FE/FM Fourtrax Foreman ES / S	450	1998	2004	R
		A	YFM 250 BRUIN	250	2005	2006	R
		A	YFM 250 Big Bear	250	2007	2009	R
		A	YFM 350 X Wolverine	350	2006	2009	R
A	YFM 350 4x4 Grizzly	350	2007	2010	R		
FSB947	APRILIA BENELLI ITALJET	S	SCARABEO 100 (Yamaha engine)	100	2000		R
		M	K2 100 BIPOSTO	100	1999		R
		M	MILLENNIUM 100	100	2000	2001	R
		M	MILLENNIUM 100	100	2002	2003	R
		M	MILLENNIUM 125	125	2000	2001	R
		M	MILLENNIUM 125	125	2001	2003	R
		M	MILLENNIUM 150	150	2000	2001	R
		M	MILLENNIUM 150	150	2001	2003	R
		S	Zion 125/150 (Rear Drum Model)	125	2008	2010	R
		M	BOOSTER 100	100	2000	2002	R
		M	DOODO 125	125	2001	2003	R
		M	SKYLINER 01 - 125	125	1998	2000	R
		M	DOODO 150	150	2001	2003	R
M	SKYLINER 150	150	2000	2002	R		
YAMAHA	M	BW'S 100	100	2000	2002	R	
	M	YN 100 NEO'S	100	2000	2003	R	
	M	BL 125 BELUGA	125	1993	1995	R	
	M	RIVA 125 XX	125	1993		R	
	M	XC 125 CYGNUS T	125	1995		F	
	M	XN 125 N TEO'S	125	2000	2003	R	
	M	XV 125 VIRAGO	125	1997	2000	R	
	M	XVS 125 DRAG STAR	125	2000		R	
	M	YBR 125 E/K (5H11/2/C/G/J/SLX/SLX9)	125	2000	2008	F/R	
	M	YBR 125 ED (3D91)	125	2005	2006	R	
	M	YBR 125 ED (5HHB/F/H)	125	2006	2008	R	
	M	YP 125 MAJESTY (SE02)	125	1998	2000	R	



...FSB947

			CC	FROM	TO	FRONT / REAR
M	RT 180		180	1993	1994	R
M	RT 180 G		180	1995	2000	R
M	TW 200		200	1993	2000	F
M	SRV 250 SOULFULTWIN RENAISSA		250	1992	1997	R
M	XV 250 S VIRAGO		250	1995	2000	R
M	XVS 250 DRAGSTAR		250	2001	2004	R
A	YFM 50 RAPTOR		50	2004	2007	R
A	YFM 80 BADGER		80	1992	2001	R
A	YFM 80 RAPTOR		80	2002	2008	R
A	YFM 80 GRIZZLY		80	2005	2008	R
A	YFA1 125 BREEZE		125	1992	2004	R
A	YFM 125 GRIZZLY		125	2004	2010	R

FSB948

A	YFB 250 D/E/F TIMBERWOLF		250	1992	1994	R
A	YFB 250 FW TIMBERWOLF		250	1994	2000	F/R
A	YFB 250		250	1995	1998	F/R
A	YFM 250 W/A/B		250	1989	1991	F
A	YFM 250 BEAR TRACKER		250	1999	2000	F/R
A	YFM 250 BEAR TRACKER		250	2001	2004	R
A	YFP 350 U Terrapro		350	1988		F
A	YFM 400 FW KODIAK		400	1999	2000	R

FSB951

M	PIAGGIO VELOFAX 50		50	1996		R
---	--------------------	--	----	------	--	---

FSB952

M	PIAGGIO CIAO 50 MIX		50	1997		F
M	SI 50 MIX		50	1997		F
M	ZIP 50 RST		50	1998	1999	R
M	ZIP 50		50	1999		F

FSB954

S	APRILIA SCARABEO 50 2T Street / 4T 4V		50	2010		R
S	Sport City One 50 (2T)		50	2008	2011	R
S	Sport City One 50 (4T)		50	2008	2009	R
S	SR MOTARD 50		50	2012		R
S	SCARABEO 100 4T		100	2001	2004	R
M	HABANA 125 all models		125	1999		R
M	SPORTCITY ONE 125		125	2010		R
S	SR 125		125	1999	2002	R
S	SR MOTARD 125		125	2012		R
S	SR 150		150	1999	2002	R
M	DERBI SONAR 125 (4T)		125	2010	2011	R
M	GILERA RUNNER 125		125		1999	R
M	RUNNER 180		180		1998	R
S	PIAGGIO Liberty Elettrico			2011	2012	R
M	FLY 50 2T		50	2005		R
M	FLY 50 4T		50	2005		R
M	LIBERTY 50		50	1997	2003	R
S	Liberty Sport 50 2T		50	2007	2008	R
S	Liberty 50 (2T / 10 Spoke Cast Wheels)		50	2009	2013	R
S	Liberty 50 (4T / 10 Spoke Cast Wheels)		50	2009	2013	R
S	Typhoon 50 (2T/12" Wheels)		50	2010	2012	R
M	VESPA PRIMAVERA 50 2T		50	2014		R
S	VESPA PRIMAVERA 50 4T 4V		50	2014		R
S	Fly 100 (4T)		100	2007	2012	R
M	FREE 100		100	2002		R
M	FLY 125		125	2004	2006	R
M	HEXAGON 125 LX		125	1998	1999	R
M	Liberty 125 (5 Spoke wheels)(M11)		125	1998	2003	R
S	Liberty 125 4T 2V (10 Spoke Cast Wheels)(M38)		125	2004	2012	R
S	Liberty Sport 125		125	2006	2008	R
S	Liberty 125 4T 3V i.e. (10 Spoke Cast Wheels)(M73)		125	2013		R
S	Liberty 125 4T 3V i-get ABS		125	2016		R
M	SKIPPER 125 ST 4T		125	1998	1999	R
M	SKIPPER ST 125 (Heng Tong caliper)		125	2000		R
M	SKIPPER ST 125 (Grimeca caliper)		125	2000		R
M	TYPHOON 125 / XR 125		125	1999	2003	R
S	Typhoon 125 (4T/12" Wheels)		125	2010	2012	R
S	VESPA PRIMAVERA 125 4T 3V i.e.		125	2013		R
S	VESPA PRIMAVERA 125 4T 3V i.e. ABS		125	2015		R
S	LIBERTY 150 (5 Spoke Wheels)		150	2000	2003	R
S	LIBERTY 150 4T (5 Spoke Wheels)		150	2008	2008	R
S	Liberty 150 4T (10 Spoke Cast Wheels)(M67)		150	2009	2012	R
S	Liberty 150 i.e. 4T 3V (10 Spoke Cast Wheels)(M73)		150	2013		R
S	Liberty 150 4T 3V i-get ABS		150	2016		R
M	SKIPPER 150 ST 4T		150	1998	1999	R
M	SKIPPER ST 150 (Heng Tong caliper)		150	2000		R
M	SKIPPER ST 150 (Grimeca caliper)		150	2000		R
S	VESPA PRIMAVERA 150 3V		150	2014		R
M	HEXAGON 180 LX		180	1998	1999	R
S	Liberty S 200		200	2007		R

FSB955

M	CZ SCRAMBLER CROSS 125		125			F/R
M	JAWA 250 CROSS		250			F/R
M	SCRAMBLER CROSS 250		250			F/R
M	SCRAMBLER CROSS 350		350			F/R
M	SCRAMBLER CROSS 380		380			F/R



FRONT / REAR

			CC	FROM	TO	FRONT / REAR
M	JAWA 400 CROSS		400			F/R
M	APRILIA HABANA 50 all models		50	1998		R
M	MOJITO CUSTOM 50		50	1999	2003	R
M	SUZUKI UE - 125 EPICURO		125	1998	2000	R
M	UC 150 EPICURO		150	1998	2000	R
A	BOMBARDIER ATV DS 50 (2 STROKE)		50	2002	2006	R
A	QUEST 50		50	2003	2004	R
A	DS 90 (2 STROKE / 4 STROKE)		90	2002	2006	R
A	QUEST 90 (2 STROKE / 4 STROKE)		90	2003	2004	R
A	DS 90 Mini 4 Stroke		90	2007		R
A	DERBI DFW 50		50	2004	2007	R
A	E-TON ATV IXL 40 Rascal		40	1998	2001	R
A	JXL40		40	2001	2005	R
A	RXL-40E Viper Junior		40	2001	2006	R
A	Viper 40 E		40	1999	2008	R
A	AXL50		50	1999	2000	R
A	NXL50		50	2001	2002	R
A	RXL50		50	2002		R
A	TXL50		50	1998	1999	R
A	RXL70		70	2005		R
A	TXL80		80	1998	1999	R
A	AXL 90 Thunder		90	1999	2000	R
A	DXL-90 Sierra		90	1999	2003	R
A	NXL 90 Thunder		90	2001	2002	R
A	RXL90		90	2002		R
A	CXL150		150	2002		R
A	Yukon ELX 150		150	2005	2006	R
A	Viper EXL 150 ST Quad		150	2005	2006	R
A	YXL 150 Yukon		150	2000	2002	R
M	HERO Splendor Plus		97	2003		F
M	Splendor Pro		97	2005		F
M	Splendor NXG		97	2007		F
M	Splendor		100	1994	2008	F
M	Pleasure		102	2005		F
M	Pleasure		102	2014		F
M	Pleasure		102	2016		F
M	iSmart 110		109	2016		F
M	Splendor Super		124	2005		F
M	WW50		50	1995		R
M	WW50DS		50	1995		R
M	WW50NS		50	1995		R
M	WW50S		50	1995		R
M	CG 125		125	1985		F
S	CHA 125 SPACY		125	1995	2003	R
M	CR 125 RS		125	1979	1981	R
M	CR 125 RZ		125	1979	1981	R
M	CR 125 RA		125	1979	1981	R
M	CR 125 RB		125	1979	1981	R
M	NX 125		125	1988		F
M	XL 125 S		125	1985		F
S	CH 250 ELITE/SPACY		250	1987	1987	F/R
S	CN 250 HELIX-FUSION		250	1993	2000	R
M	CR 250 RB		250	1981	1981	R
M	CR 250 RC		250	1982	1982	R
M	XL 250 R		250	1982	1988	F
M	XLX 250		250	1984		F
A	HONDA ATV TRX 70 Fourtrax		70	1986	1987	R
S	ITALJET Velocifero 50		50	1998	2003	F
S	KYMCO AGILITY CITY 50 R16 (4T/2T)		50	2008		R
S	AGILITY 50 R16 + (2T)		50	2015		R
S	AGILITY 50 R16 + (4T)		50	2015		R
S	PEOPLE 50 (2T)		50	1999	2011	R
S	PEOPLE S 50 (2T)		50	2005	2010	R
S	PEOPLE S 50 ELEGANCE (4T)		50	2006	2013	R
S	SUPER 8 50 2T/4T		50	2007		R
S	AGILITY 125 R12 (4T)		125	2006		R
S	AGILITY RS 125 R12 (2T)		125	2009	2013	R
S	AGILITY RS 125 R12 (4T)		125	2010		R
S	AGILITY RS 125 R12 (4T) Naked +		125	2010		R
S	Capture 125		125	2010		R
S	MOVIE 125		125	1998	2000	R
S	MOVIE XL 125		125	2001	2009	R
S	PEOPLE 125		125	1999	2005	R
S	PEOPLE S 125		125	2005	2006	R
S	PEOPLE ONE 125i		125	2013	2014	R
S	Racing 125 Fi		125	2010	2015	R
S	SUPER 8 125		125	2008	2013	R
M	VIVIO 125		125	2000	2003	R
S	MOVIE XL 150		150	2001	2009	R
M	PEOPLE 150		150	1999		R

M = MOTORCYCLE
S = SCOOTER
A = ATV
Sn = SNOWMOBILE

FERODO

RACING

Updated on November 2020

6019



CC FROM TO FRONT / REAR

Code	Model	Year	CC	FROM	TO	FRONT / REAR
...FSB958	MALAGUTI	S Racing 150Fi	150	2010	2014	R
		S Super 8	150	2007	2014	R
		S Vivio 150	150	2000	2003	R
		M YAGER 150	150	2001		R
		S PEOPLE S 200	200	2004	2010	R
		M CIAK 125	125	2001		R
M CIAK 150	150	2001		R		
FSB959	SYM	M HUSKY 125	125	2000		R
		M HUSKY 150	150	2000		R
FSB960	SYM	S Allo 50 (4T)	50	2011		R
		S Allo GT 50 (4T)	50	2013		R
		M SHARK 50	50	1999	2003	R
		S Allo 125 (4T)	125	2011		R
		M ATTILA 125	125	1999	2000	R
		S HD 125	125	2004	2007	R
		S HD 125 S Evo	125	2007		R
		M MEGALO 125	125	2000		R
		M EURO MX 125	125	2002		R
		S Orbit 125	125	2008	2009	R
		S Tonic 125	125	2011		R
		M VS 125	125	2006		R
		S Allo 150 (4T)	150	2011		R
		S Jet4 (150cc/4T)	150	2013		R
		M EURO MX 150	150	2002		R
		M SUPER DUKE 150	150	1999		R
		M VS 150	150	2006		R
		M HD 200	200	2004	2005	R
	TGB	S 303RHawk/Laser (125cc)	125	2004	2008	R
		S 303RHawk/Laser (125cc)	125	2009		R
		S Delivery/Express(125cc)	125	2004		R
		S 303RHawk/Laser (150cc)	150	2004	2008	R
		S 303RHawk/Laser (150cc)	150	2009		R
FSB963	HERO	M Passion Plus	110	2012		R
		M CBZ	150	1999	2006	R
		M Karizma	220	2003		R
	HONDA	S BENLY	50	2012	2017	F/R
		S BENLY PRO	50	2012	2017	F/R
		S GYRO Canopy	50	2008	2017	F/R
		S GYRO X	50	2008	2017	F/R
		M NSC 50 C,AC Vision & R	50	2012		R
		S PRESS CUB 50 DELUXE	50	2000	2008	R
		S PRESS CUB 50 STANDARD	50	2000	2008	R
		S SUPER CUB 70	70	1999	2008	F
		S SUPER CUB 90	90	1999	2008	F
		M NH 100 LEAD	100	2000		R
		S SCV 100 Lead	100	2002	2006	R
		S SPACY 100	100	2002	2007	R
		S Activa	110			R
		S Aviator	110	2009		R
		S BENLY 110	110	2012		F/R
		S BENLY 110 PRO	110	2012		F/R
		M C110	110	2018		R
		M CT 110	110	2005	2009	R
		S NHX Elite	110	2010	2011	R
		S NFC Moove	110	2014		R
		M NSC 110 WHB,AC Vision	110	2011		R
		S Scoopy 110i	110	2012		R
		S SCR 110	110	2013		R
		M SCV 110 Lead (WHA)	110	2010	2011	R
		S SUPER CUB 110	110	2009	2012	R
		S Taranis 110 GP	110	2012		R
		S Zoomer X	110	2013		R
		M RAVI	115	2017		F/R
		S Activa	125			R
		S AROBASE 125	125	2000	2006	R
	M CB Shine	125	2010		R	
	M CB 125 F	125	2015	2016	R	
	M CBF 125 M	125	2009		R	
	M CBR 125 M	125	2009	2017	R	
	M CG 125	125	2007	2008	R	
	S CG 125 CARGO SINGLE SEAT	125	2002	2003	R	
	S CG 125 TITAN	125	2002	2005	R	
	M CG 125 WH	125	2016	2017	F	
	S Click 125i	125	2012	2017	R	
	S DIO 125	125	2010		R	
	M 125 DYLAN	125	2002		R	
	S NHX Lead	125	2013	2017	R	
	M @ 125 NES	125	2000		R	
	M @ 125 NES	125	2001		R	
	S NXR 125 BROS	125	2004		R	



CC FROM TO FRONT / REAR

Code	Model	Year	CC	FROM	TO	FRONT / REAR
	M PCX 125 (WW125 EX2)	125	2010	2013		R
	M PCX 125 LIMITED EDITION (WW125 EX2)	125	2012			R
	S PES 125 INJECTION	125	2006	2010		R
	S PES 125 INJECTION SPORTY	125	2008	2009		R
	S PS 125 i	125	2007			R
	M SH 125 (JF09)	125	2001	2004		R
	M SH 125i (JF14)	125	2005	2007		R
	S SH 125 Mode (JF51)	125	2014			R
	S SH 125 SPECIAL	125	2004	2007		R
	S SH 125 S	125	2007			R
	S SH 125 R	125	2008			R
	S SH 125 D	125	2009			R
	S SPACY 125	125	2004	2007		R
	S SPACY 125 LEARNING	125	2007			R
	M XLR 125	125	2003			R
	S AROBASE 150	150	2000	2004		R
	M CBF 150	150	2005			R
	S CG 150 JOB	150	2004	2007		R
	S CG 150 TITAN Electric Start	150	2004	2010		R
	S CG 150 TITAN Kick Start	150	2004	2010		R
	S CG 150 CARGO	150	2007			R
	S CG 150 FAN	150	2010			R
	S DYLAN 150	150	2002	2009		R
	S DYLAN 150 REPSOL	150	2002			R
	M @ 150 NES	150	2000			R
	S NXR 150 BROS	150	2009	2011		R
	M PCX 150 (WW150)	150	2012			R
	S PCX 150 ABS	150	2018			R
	S PES 150 INJECTION	150	2006	2010		R
	S PES 150 R TWO TONES	150	2008	2009		R
	S PES 150 R INJECTION	150	2010			R
	S PS 150i	150	2008			R
	M SH 150 (KF04)	150	2001	2004		R
	S SH 150 SPECIAL 2ED	150	2004	2006		R
	M SH 150 (KF08)	150	2005	2008		R
	S SH 150 R	150	2008			R
	S SH 150 S	150	2008			R
	M CB 223 S	223	2008	2016		R
	M FTR 223	223	2000	2016		R
	S XL 230	230	2002			R
	S CBF 250	250	2004	2009		R
	S CBX 250 TWISTER	250	2001	2008		R
	S XR 250 TORNADO	250	2001	2009		R
FSB964	DAELIM	M OTELLO / NS 125	125	1999		R
		M ROCKET 125	125	1999	2001	R
		M VS 125 CUSTOM	125	2001		R
	SYM	S Symphony 50 (4T/Rear drum model)	50	2009		R
		S Fiddle II 125	125	2009	2013	R
		S Fiddle III 125 (4T)	125	2014		R
		S JET 4 (125cc- 4T)	125	2009		R
		S Symphony 125 (4T/Rear drum) (AY12W)	125	2009		R
		S Symply 125	125	2007	2008	R
		S Symply II 125	125	2009		R
		S X Pro 125	125	2013		R
		S Fiddle II 151	151	2010		R
FSB966	ARCTIC CAT	A 90-Y12 Youth (2T-4T)	90	2002	2005	R
	CAN AM ATV	A DS 70 (2x4/4T) Mini	70	2008		R
	KYMCO	M CK1 125	125	2014		R
	KYMCO ATV	A MAXXER 50	50	2005		R
		A Mongoose 50 (2T)	50	2004	2008	R
	PEUGEOT	S Tweet 50 (4T/Rear Drum Model)	50	2010	2013	R
		S Tweet 50 Evo	50	2014		R
		S Kisbee 100 (K3)	100	2013		R
	POLARIS ATV	A Outlaw 50	50	2007	2010	R
		A PREDATOR 50	50	2004	2006	R
		A Predator 50 (2 stroke)	50	2004	2006	R
		A SCRAMBLER 50	50	2001	2006	R
		A Outlaw 90	90	2007	2010	R
		A PREDATOR 90	90	2003	2006	R
		A SCRAMBLER 90	90	2001	2003	R
		A SPORTSMAN 90	90	2001	2010	R
	SYM	S Orbit II 50 (4T)	50	2012		R
		S Orbit II 50 Naked (4T)	50	2012		R
		S Tonic 110 (4T)	110	2011	2013	R
		S JETV (125cc/4T)	125	2012	2013	R
		M SHARK 125	125	1999	2002	R
		M SHARK 150	150	1999	2002	R
FSB967	MBK	M YW 125 Z X-Over	125	2010	2010	R
	YAMAHA	M BW's 125	125	2010		R
		M NCX 125 CYGNUS X 220mm disc (5ML)	125	2004	2006	R



				CC	FROM	TO	FRONT / REAR
...FSB967		S	NCX 125 CYGNUS X 240mm disc (4P9)	125	2006	2013	R
		S	NXC 125 K CYGNUS X Cab (HC6-1)	125	2007	2010	R
		S	NXC 125 K CYGNUS X Injection (4C6-2)	125	2007	2010	R
		M	Xenter 125 (SE59)	125	2012		R
		S	YW 125 X (1DN1/2)	125	2010	2013	R
		M	Xenter 150	150	2012		R
FSB970	HERO	M	Passion Pro TR	97	2014		R
		M	Passion Pro	97	2016		R
		M	Maestro	109	2012		F/R
		M	Passion XPro	109	2012		R
		M	Passion XPro	109	2016		R
		M	Maestro Edge	110	2016		F/R
		M	SUPER SPLENDOR	125			R
		M	Hunk	149	2013	2015	F/R
		M	Hunk	149	2016		F/R
		M	Karizma R	223	2003		R
		M	Karizma R	223	2014		R
		M	Karizma	223	2016		R
FSB971	BAJAJ	M	CT 100	99	2011		F/R
		M	Kawasaki 4S	100	1991	1997	F/R
		M	Platina 100 ES	102	2011		F/R
		M	Caliber	110	1998	2003	F/R
		M	Platina 125 DTS-Si	124	2010		F/R
		M	Platina 125 Dumdaar Sawari	124	2011		F/R
		M	Platina	125	2006		F/R
FSB973	SUZUKI	M	Heat	125	2006	2008	F/R
		M	Zeus	125	2006	2010	F/R
FSB974	YAMAHA	M	Enticer	125	2002	2005	R
		M	Fazer	125	2004	2006	R
		M	Fazer	150	2009		R
		M	FZ1	150	2009		R
FSB975	SUZUKI	M	Hayate	110	2012		F/R
FSB977	YAMAHA	M	RX100	100	1985	1996	F/R
		M	Libero	110	2002	2010	F/R
		M	YBX	125	1998	2000	F/R
		M	RX135	135	1998	2005	F/R
FSB978	ROYAL ENFIELD	M	Bullet 350	346	2009		R
		M	Bullet 350 Twinspark	346	2013		F/R
		M	Classic 350	346	2013		F/R
		M	Bullet 350	350	2010		F/R
FSB979	TVS	S	Scotty ES	85	2005		F/R
		M	Scooty Pep+	87	2005		F/R
		M	Scooty Pep+	87	2015		F/R
		M	StarCity	109	2006		F/R
		M	StarCity +	109	2015		F/R
		M	Victor GL	109	2003		F/R
		M	Victor	109	2016		F/R
		M	Star City	110	2004		F/R
		M	Victor	110	2001	2007	F/R
		M	Victor 125 GLX	124	2004		F/R
		M	Victor Edge	124	2005		F/R
		M	Victor	125	2004	2008	F/R
		M	Apache 150	147	2005		R
		M	Apache	150	2006	2008	R
		M	Fiero F2	150	2003	2006	R
		M	Apache RTR 160	159	2015		R
M	Apache	160	2008		R		
FSB982	PIAGGIO (motocarr)	M	APE POKER 420 BENZINA	420	1993		F
		M	APE POKER 420 DIESEL	420	1993	1997	F
		M	QUARGO 750 DIESEL	750	2004	2006	F
FSB983	PIAGGIO (motocarr)	M	APE POKER 420 BENZINA	420	1993		R
		M	APE POKER 420 DIESEL	420	1993	1997	R
		M	VTL 500 QUARGO	500	2005		R
		M	QUARGO 750 DIESEL	750	2004	2006	R

M = MOTORCYCLE
S = SCOOTER
A = ATV
Sn = SNOWMOBILE





**PADS XREF
COMPETITORS TO FERODO**



BRAKE PADS X-REF

COMPETITORS - OE TO FERODO

BRAKING	Ferodo	BRAKING	Ferodo	BRAKING	Ferodo	BRAKING	Ferodo
612	FDB207	739	FDB2050	869	FDB2096	952	FDB2266
613	FDB108	741	FDB706	870	FDB2120	953	FDB2186
621	FRP405	742	FDB754	871	FDB2115	954	FDB2256
622	FDB151	743	FDB828	873	FDB2157	955	FDB2262
644	FDB204	744	FDB636	875	FDB2111	956	FDB2258
645	FDB183	746	FDB2018	878	FDB2128	957	FDB2281
646	FDB218	748	FDB2225	879	FDB2124	958	FDB2254
648	FDB694	750	FDB781	883	FDB2141	959	FDB2079
652	FDB298	751	FDB637	884	FDB2140	960	FDB2265
653	FDB2075	756	FDB858	886	FDB2139	961	FDB2264
654	FDB244	757	FDB625	887	FDB2132	962	FDB2075
658	FDB311	760	FDB784	888	FDB2142	963	FDB2108
661	FDB337	761	FDB680	890	FDB2162	964	FDB2201
662	FDB339	764	FDB873	891	FDB2165	965	FDB2275
667	FDB382	770	FDB677	892	FDB2125		
669	FDB314	772	FDB892	893	FDB2164	BREMBO	Ferodo
671	FDB436	773	FDB2005	894	FDB2110	07.008	FDB436
673	FDB312	774	FDB2101	895	FDB2145	07.7874.24	FDB2166
679	FDB386	775	FDB2012	896	FDB2173	07.8354.24	FDB2228
680	FDB389	776	FDB2007	897	FDB2183	07.8493.12	FDB2165
681	FDB673	777	FDB2003	898	FDB2178	07.92.8720	FDB2210
683	FDB583	778	FDB2081	899	FDB2181	07.9340.10	FDB2122
684	FDB438	779	FDB889	900	FDB2179	07.9340.20	FDB2170
685	FDB383	780	FDB2006	901	FDB2180	07.9340.90	FDB2171
686	FDB381	782	FDB2048	902	FDB2169	07.B366.90	FDB2278
687	FDB411	784	FDB2042	903	FDB2156	07.GR05	FDB2206
688	FRP408	785	FDB2133	904	FDB2200	07003	FDB680
690	FDB663	786	FDB605	905	FDB2197	07004	FDB2074
692	FDB662	787	FDB2049	906	FDB2158	07005	FDB2190
694	FDB697	794	FDB2039	907	FDB2198	07006	FDB438
696	FDB497	795	FDB497	908	FDB2212	07007	FDB2060
698	FDB481	796	FDB2190	909	FDB2207	07009	FDB697
700	FDB495	801	FDB2036	910	FDB2196	07010	FDB783
701	FDB539	805	FDB2037	911	FDB2182	07011	FDB672
702	FDB313	806	FDB2050	923	FDB2184	07012	FDB677
703	FDB250	808	FDB2057	924	FDB2213	07013	FDB784
704	FDB462	812	FDB2080	925	FDB2221	07014	FDB828
705	FDB2015	813	FDB2073	926	FDB2208	07015	FDB828
707	FDB557	814	FDB2062	927	FDB2220	07016	FDB2101
709	FDB606	817	FDB404	928	FDB2217	07017	FDB2037
711	FDB531	822	FDB2083	929	FDB2219	07018	FDB2191
712	FDB508	826	FDB2084	931	FDB2245	07019	FDB2057
715	FDB574	827	FDB2079	932	FDB2244	07020	FDB2090
716	FDB570	828	FDB2074	933	FDB2216	07021	FDB2095
717	FDB569	830	FDB2085	939	FDB2240	07022	FDB2096
719	FDB338	831	FDB2109	940	FDB382	07023	FDB2129
720	FDB664	832	FDB2127	941	FDB2252	07024	FDB250
722	FDB659	840	FDB2090	942	FDB2253	07031	FDB2192
725	FDB631	842	FDB2095	943	FDB2250	07032	FDB625
726	FDB498	853	FDB2105	944	FDB2251	07033	FDB2087
728	FDB607	856	FDB2054	945	FDB2248	07034	FDB2073
729	FDB666	857	FDB2055	947	FDB2255	07034	FDB2075
732	FDB352	860	FDB2121	948	FDB2226	07035	FDB497
734	FDB2001	862	FDB2148	949	FDB2257	07036	FDB2133
735	FDB591	867	FDB2143	950	FDB2259	07037	FDB2085
737	FDB737	868	FDB2126	951	FDB2202	07038	FDB2086

BRAKE PADS X-REF

COMPETITORS - OE TO FERODO

BREMBO	Ferodo	BREMBO	Ferodo	BREMBO	Ferodo	BREMBO	Ferodo
07038	FDB2119	07BB16	FDB529	07GR81	FDB2184	07HO43	FDB2098
07039	FDB383	07BB18	FDB680	07HD01	FDB185	07HO45	FDB2114
07040	FDB2226	07BB19	FDB2042	07HD02	FDB333	07HO47	FDB2042
07041	FDB636	07BB20	FDB2074	07HD03	FDB334	07HO48	FDB2139
07042	FDB2003	07BB21	FDB736	07HD04	FDB335	07HO49	FDB2143
07043	FDB2083	07BB22	FDB2050	07HD06	FDB352	07HO50	FDB2181
07044	FRP405	07BB23	FDB204	07HD07	FDB2251	07HO52	FDB2075
07045	FDB2105	07BB25	FDB2102	07HD09	FDB485	07HO53	FDB2258
07047	FDB2115	07BB26	FDB2125	07HD10	FDB2001	07HO55	FDB2182
07048	FDB2128	07BB27	FDB2165	07HD11	FDB847	07HO56	FDB2169
07050	FDB2141	07BB31	FDB2081	07HD12	FDB2097	07HO57	FDB2196
07051	FDB2140	07BB32	FDB2074	07HD13	FDB2179	07HO58	FDB2195
07052	FDB2126	07BB33	FDB2255	07HD14	FDB2180	07HO59	FDB2221
07053	FDB2130	07BB35	FDB2243	07HD15	FDB2250	07HO60	FDB2281
07054	FDB2147	07BB37	FDB2260	07HD16	FDB2097	07HO61	FDB2275
07055	FDB2132	07BB38	FDB2265	07HD18	FDB2202	07KA01	FDB132
07056	FDB2142	07GR01	FDB213	07HD19	FDB2240	07KA04	FDB220
07057	FDB2146	07GR02	FDB205	07HD20	FDB2079	07KA05	FDB299
07058	FDB2173	07GR03	FDB2242	07HD21	FDB2018	07KA06	FDB298
07059	FDB2200	07GR04	FDB828	07HD22	FDB2196	07KA07	FDB313
07060	FDB2186	07GR06	FDB2252	07HD23	FDB2306	07KA08	FDB339
07061	FDB2207	07GR09	FDB384	07HO01	FDB119	07KA09	FDB481
07062	FDB2108	07GR10	FDB696	07HO03	FDB182	07KA10	FDB494
07063	FDB2196	07GR12	FDB312	07HO04	FDB134	07KA11	FDB508
07064	FDB2212	07GR13	FDB624	07HO07	FDB183	07KA12	FDB659
07065	FDB2208	07GR14	FDB706	07HO09	FDB250	07KA13	FDB574
07066	FDB2062	07GR16	FDB2257	07HO10	FDB244	07KA14	FDB741
07068	FDB2224	07GR18	FDB2266	07HO10	FDB665	07KA15	FDB2049
07069	FDB2254	07GR20	FDB2262	07HO11	FDB313	07KA16	FDB2012
07070	FDB2148	07GR21	FDB782	07HO13	FDB312	07KA17	FDB892
07085	FDB2248	07GR22	FDB2271	07HO14	FDB310	07KA18	FDB2049
07086	FDB889	07GR23	FDB2267	07HO15	FDB382	07KA19	FDB2048
07090	FDB2256	07GR25	FDB2272	07HO17	FDB310	07KA20	FDB2036
07092	FDB2284	07GR26	FDB2273	07HO18	FDB538	07KA21	FDB2111
07093	FDB2264	07GR27	FDB2274	07HO20	FDB381	07KA22	FDB2080
07098	FDB570	07GR35	FDB2198	07HO21	FDB462	07KA23	FDB2158
07100XS	FDB2322	07GR48	FDB2127	07HO21	FDB2113	07KA24	FDB2080
07101	FDB2291	07GR49	FDB2148	07HO22	FDB661	07KA25	FDB2188
07102	FDB2282	07GR50	FDB2149	07HO23	FDB452	07KA27	FDB2110
07BB01	FDB207	07GR50	FDB2235	07HO25	FDB495	07KA28	FDB2220
07BB02	FDB2005	07GR51	FDB2103	07HO26	FDB539	07KA29	FDB2114
07BB03	FDB2006	07GR52	FDB2184	07HO27	FDB531	07KS02	FDB151
07BB04	FDB2018	07GR54	FDB2175	07HO28	FDB533	07KS04	FDB314
07BB04	FDB2039	07GR56	FDB498	07HO29	FDB495	07KS05	FDB338
07BB05	FDB2120	07GR58	FDB2109	07HO30	FDB570	07PO01	FDB2055
07BB06	FDB592	07GR59	FDB155	07HO31	FDB664	07PO03	FDB2054
07BB07	FDB314	07GR62	FDB2124	07HO32	FDB382	07PO04	FDB2121
07BB08	FDB2062	07GR66	FDB342	07HO33	FRP416	07PO06	FDB2176
07BB09	FDB499	07GR68	FDB2145	07HO34	FDB2225	07PO07	FDB2236
07BB10	FDB2007	07GR69	FDB2157	07HO35	FDB663	07PO10	FDB2263
07BB12	FDB2107	07GR70	FDB2183	07HO36	FDB754	07PO11	FDB2276
07BB12	FRP405	07GR71	FDB2141	07HO37	FDB2259	07SU01	FDB150
07BB13	FDB694	07GR72	FDB2201	07HO38	FDB625	07SU02	FDB178
07BB14	FDB108	07GR75	FDB2245	07HO39	FDB2002	07SU03	FDB218
07BB14	FDB148	07GR76	FDB2244	07HO41	FDB664	07SU04	FDB217
07BB15	FRP408	07GR77	FDB2216	07HO42	FDB2073	07SU06	FDB389

BRAKE PADS X-REF

COMPETITORS - OE TO FERODO

BREMBO	Ferodo	BREMBO	Ferodo	BREMBO	Ferodo	BRENTA	Ferodo
07SU07	FDB390	07YA41	FDB2162	7052	FDB2126	3021	FDB2087
07SU08	FDB673	07YA45	FDB2193	7053	FDB2130	3022	FDB2083
07SU09	FDB404	07YA46	FDB2217	7054	FDB2147	3023	FDB2075
07SU10	FDB437	07YA47	FDB2219	7055	FDB2132	3023B	FDB2073
07SU11	FDB2013	07YA48	FDB2230	7056	FDB2142	3024	FDB2115
07SU12	FDB497	07YA49	FDB2231	7057	FDB2146	3025	FDB784
07SU13	FDB569	07YA50	FDB2232	7058	FDB2173	3026	FDB438
07SU14	FDB557	07YA51	FDB2233	7059	FDB2200	3027	FDB2018
07SU15	FDB606	07YA52	FDB2280	7060	FDB2186	3028	FDB2095
07SU16	FDB2049	07YA53	FDB2283	7061	FDB2207	3029	FDB207
07SU17	FDB607	107268641	FRP416	7062	FDB2108	3030	FRP408
07SU18	FDB659	107684820 (Z01)	FDB2007	7063	FDB2196	3031	FDB498
07SU19	FDB873	7001	FDB2018	7064	FDB2212	3032	FDB2183
07SU19	FDB2144	7003	FDB680	7065	FDB2208	3034	FDB2119
07SU20	FDB2058	7004	FDB2074	7066	FDB2062	3034B	FDB382
07SU22	FDB557	7005	FDB2190	7067	FDB2057	3035	FDB2074
07SU25	FDB2111	7006	FDB438	7068	FDB2224	3036	FDB2140
07SU26	FDB2164	7007	FDB2060	7069	FDB2254	3037	FDB2141
07SU27	FDB2178	7009	FDB697	7070	FDB2148	3038	FDB2154
07SU29	FDB2016	7010	FDB783	7071	FDB631	3039	FDB2103
07SU30	FDB2163	7011	FDB672	7073	FDB781	3040	FDB2109
07SU31	FDB2197	7012	FDB677	7074	FDB570	3041	FDB2142
07SU32	FDB2213	7013	FDB784	7075	FDB570	3042	FDB2127
07YA03	FDB177	7016	FDB2101	7076	FDB497	3043	FDB2147
07YA04	FDB247	7017	FDB2037	7078	FDB382	3046	FDB2139
07YA07	FDB184	7018	FDB2191	7080	FDB312	3047	FDB2132
07YA08	FDB277	7019	FDB2057	7083	FDB2006	3048	FDB2128
07YA09	FDB2085	7020	FDB2090	7085	FDB2248	3049	FDB2096
07YA10	FDB311	7021	FDB2095	7086	FDB889	3050	FDB2096
07YA11	FDB337	7022	FDB2096	7087	FDB2081	3051	FDB2096
07YA12	FDB386	7023	FDB2129	7090	FDB2256	3052	FDB338
07YA13	FDB411	7024	FDB250	7092	FDB2284	3053	FDB337
07YA14	FDB383	7025	FDB538	7093	FDB2264	3054	FDB338
07YA14	FDB475	7028	FDB672	7096	FDB2225	3055	FDB706
07YA15	FDB2014	7029	FDB531	7098	FDB570	3056	FDB2165
07YA16	FDB2015	7031	FDB2192	7100	FDB2216	3057	FDB781
07YA17	FDB449	7032	FDB625	7101	FDB2291	3058	FDB2126
07YA18	FDB583	7033	FDB2087	7102	FDB2282	3059	FDB570
07YA19	FDB591	7034	FDB2073	7103	FDB2292	3060	FDB873
07YA20	FDB631	7034	FDB2075	7104	FDB2055	3061	FDB339
07YA22	FDB631	7035	FDB497	7109	FDB2277	3062	FDB574
07YA23	FDB605	7036	FDB2133	7110	FDB2143	3063	FDB497
07YA24	FDB666	7037	FDB2085	M028Z04 (Z04)	FDB2007	3064	FDB631
07YA25	FDB737	7038	FDB2086			3067	FDB2081
07YA26	FDB637	7038	FDB2119	BRENTA	Ferodo	3069	FDB312
07YA27	FDB781	7039	FDB383	3010	FDB680	3070	FDB497
07YA28	FDB2238	7040	FDB2226	3011	FDB889	3071	FDB664
07YA29	FDB889	7041	FDB636	3012	FDB697	3072	FDB754
07YA30	FDB636	7042	FDB2003	3013	FDB436	3073	FDB531
07YA32	FDB864	7043	FDB2083	3014	FDB2057	3074	FDB313
07YA34	FDB2003	7044	FRP405	3015	FRP405	3075	FDB313
07YA35	FDB662	7045	FDB2105	3016	FDB2062	3076	FDB636
07YA37	FDB2083	7047	FDB2115	3017	FDB677	3077	FDB2224
07YA38	FDB2084	7048	FDB2128	3018	FDB2085	3078	FDB2200
07YA39	FDB2156	7050	FDB2141	3019	FDB2003	3079	FDB2207
07YA40	FDB2150	7051	FDB2140	3020	FDB2090	3080	FDB2208

BRAKE PADS X-REF

COMPETITORS - OE TO FERODO

BRENTA	Ferodo	BRENTA	Ferodo	BRENTA	Ferodo	BRENTA	Ferodo
3081	FDB2196	3152	FDB2238	4064	FDB631	4125	FDB2206
3082	FDB2212	3153	FDB2284	4067	FDB2081	4127	FDB557
3083	FDB250	3154	FDB2266	4069	FDB312	4129	FDB2253
3084	FDB2039	3155	FDB2258	4070	FDB497	4130	FDB2256
3085	FDB383	4010	FDB680	4071	FDB664	4131	FDB2213
3086	FDB659	4011	FDB889	4072	FDB754	4132	FDB625
3087	FDB539	4012	FDB697	4073	FDB531	4133	FDB2184
3088	FDB2005	4013	FDB436	4074	FDB313	4134	FDB437
3089	FDB2012	4014	FDB2057	4075	FDB313	4135	FDB449
3090	FDB2006	4015	FRP405	4076	FDB636	4136	FDB858
3091	FDB2049	4016	FDB2062	4077	FDB2224	4137	FDB2111
3092	FDB2048	4017	FDB677	4078	FDB2200	4138	FDB666
3093	FDB2042	4018	FDB2085	4079	FDB2207	4139	FDB2156
3094	FDB605	4019	FDB2003	4080	FDB2208	4140	FDB664
3095	FDB314	4020	FDB2090	4081	FDB2196	4141	FDB108
3096	FDB2105	4021	FDB2087	4082	FDB2212	4142	FDB2201
3097	FDB2186	4022	FDB2083	4083	FDB250	4143	FDB452
3098	FDB2216	4023	FDB2075	4084	FDB2039	4144	FDB2235
3099	FDB2190	4023B	FDB2073	4085	FDB383	4145	FDB2265
3100	FDB2226	4024	FDB2115	4086	FDB659	4146	FDB2264
3101	FDB2162	4026	FDB438	4087	FDB539	4147	FDB2169
3102	FDB2226	4027	FDB2018	4088	FDB2005	4148	FDB737
3103	FDB2248	4028	FDB2095	4089	FDB2012	4149	FDB2108
3104	FDB452	4029	FDB207	4090	FDB2006	4150	FDB2279
3105	FDB2219	4030	FRP408	4091	FDB2049	4151	FDB2275
3106	FDB381	4031	FDB498	4092	FDB2048	4152	FDB2238
3107	FDB2120	4032	FDB2183	4093	FDB2042	4153	FDB2284
3108	FDB2148	4034	FDB2119	4094	FDB605	4154	FDB2266
3109	FDB2148	4035	FDB2074	4095	FDB314	4155	FDB2258
3110	FDB2149	4036	FDB2140	4096	FDB2105	4157	FDB2055
3111	FDB2149	4038	FDB2154	4097	FDB2186	4158	FDB2055
3112	FDB2079	4039	FDB2103	4098	FDB2216	4159	FDB2257
3116	FDB2181	4040	FDB2109	4099	FDB2190	4160	FDB2157
3117	FDB2178	4041	FDB2142	4100	FDB2226	4161	FDB2262
3120	FDB2158	4042	FDB2127	4101	FDB2162	4162	FDB2242
3125	FDB2206	4043	FDB2147	4102	FDB2226	4163	FDB2251
3127	FDB557	4044B	FDB382	4103	FDB2248	4164	FDB2202
3129	FDB2253	4046	FDB2139	4104	FDB452	4165	FDB2097
3130	FDB2256	4047	FDB2132	4105	FDB2219	4166	FDB2179
3131	FDB2213	4047	FDB2141	4106	FDB381	4167	FDB2180
3132	FDB625	4048	FDB2128	4107	FDB2120	4168	FDB2018
3133	FDB2184	4049	FDB2096	4108	FDB2148	4170	FDB2114
3134	FDB437	4050	FDB2096	4109	FDB2148	4171	FDB2210
3137	FDB2111	4051	FDB2096	4110	FDB2149	4172	FDB2250
3139	FDB2156	4052	FDB338	4111	FDB2149		
3140	FDB664	4053	FDB337	4112	FDB2079	CL BRAKES	Ferodo
3141	FDB108	4054	FDB338	4113	FDB2260	1033	FDB2120
3142	FDB2201	4055	FDB706	4115	FDB2220	1034	FDB2110
3143	FDB452	4056	FDB2165	4116	FDB2181	1066	FDB2150
3144	FDB2235	4057	FDB781	4117	FDB2178	1067	FDB2143
3146	FDB2264	4058	FDB2126	4118	FDB2217	1075	FDB2166
3147	FDB2169	4059	FDB570	4119	FDB2164	1076	FDB2139
3148	FDB737	4060	FDB873	4120	FDB2158	1078	FDB2157
3149	FDB2108	4061	FDB339	4122	FDB2255	1083	FDB2158
3150	FDB2279	4062	FDB574	4123	FDB2125	1084	FDB2156
3151	FDB2275	4063	FDB497	4124	FDB2124	1101	FDB2125

BRAKE PADS X-REF

COMPETITORS - OE TO FERODO

CL BRAKES	Ferodo	CL BRAKES	Ferodo	CL BRAKES	Ferodo	CL BRAKES	Ferodo
1102	FDB2149	2285	FDB339	2396	FDB2006	2987	FDB2102
1102	FDB2235	2287	FDB2192	2398	FDB498	3003	FDB570
1103	FDB2162	2288	FDB497	2400	FDB499	3004	FDB697
1108	FDB2165	2289	FDB665	2404	FDB2036	3005	FDB784
1128	FDB2183	2296	FDB754	2408	FDB250	3005	FDB2100
1133	FDB2178	2298	FDB531	2408	FDB625	3008	FDB383
1134	FDB2181	2299	FDB659	2424	FDB2015	3009	FDB2192
1139	FDB2145	2300	FDB495	2430	FDB2050	3011	FDB244
1140	FDB2182	2300	FDB892	2451	FDB382	3012	FDB828
1142	FDB2188	2301	FDB386	2466	FDB731	3013	FDB680
1144	FDB706	2302	FDB495	2469	FDB313	3014	FDB672
1145	FDB2163	2303	FDB2050	2472	FDB828	3015	FRP405
1146	FDB677	2304	FDB481	2539	FDB2042	3016	FRP405
1147	FDB2184	2305	FDB449	2546	FDB2003	3017	FDB538
1148	FDB2169	2306	FDB314	2586	FDB887	3018	FDB625
1149	FDB2179	2307	FDB680	2599	FDB185	3019	FDB382
1150	FDB2180	2307	FDB889	2602	FDB2073	3019	FDB2119
1151	FDB2141	2308	FDB606	2602	FDB2075	3020	FDB2060
1152	FDB2197	2309	FDB637	2602	FDB2098	3022	FDB313
1153	FDB2096	2310	FDB452	2621	FDB312	3023	FDB313
1159	FDB2196	2311	FDB449	2694	FDB218	3024	FDB828
1163	FDB2213	2311	FDB666	2696	FDB636	3025	FDB2003
1165	FDB2176	2313	FDB664	2699	FDB352	3026	FDB2073
1172	FDB2210	2314	FDB539	2700	FDB333	3026	FDB2075
1174	FDB2221	2314	FDB672	2701	FDB335	3027	FDB2062
1175	FDB2085	2326	FDB631	2711	FDB2079	3029	FDB636
1177	FDB2220	2328	FDB381	2711	FDB2114	3030	FDB636
1180	FDB2217	2328	FDB661	2713	FDB2084	3031	FDB497
1185	FDB2260	2329	FDB2007	2718	FDB334	3031	FDB677
1187	FDB2216	2329	FDB2123	2720	FDB2167	3033	FDB2083
2245	FDB533	2332	FDB108	2750	FDB2080	3034	FDB436
2246	FDB557	2332	FDB148	2792	FDB411	3036	FDB631
2247	FRP408	2342	FDB485	2794	FDB438	3037	FDB694
2248	FDB663	2352	FDB2018	2799	FDB2013	3038	FDB625
2249	FDB207	2353	FDB2005	2801	FDB592	3041	FDB2101
2251	FDB574	2360	FDB737	2802	FDB311	3043	FDB2057
2252	FDB462	2361	FDB605	2807	FDB277	3047	FDB2191
2252	FDB2113	2363	FDB741	2813	FDB2111	3049	FDB2085
2253	FDB662	2369	FDB847	2814	FDB182	3054	FDB2115
2254	FDB864	2370	FDB2001	2827	FDB2074	3056	FDB2105
2255	FDB873	2377	FDB2107	2828	FDB2083	3059	FDB664
2255	FDB2144	2377	FRP405	2840	FDB204	3060	FDB2142
2256	FDB570	2381	FDB2012	2847	FDB177	3061	FDB2200
2257	FDB2002	2382	FDB244	2899	FDB2036	3065	FDB570
2258	FDB736	2382	FDB538	2900	FDB2039	3066	FDB2173
2260	FDB784	2383	FDB2048	2914	FDB2133	3073	FDB2119
2260	FDB2100	2384	FDB2049	2920	FDB2033	3074	FDB2132
2269	FDB2194	2385	FDB496	2923	FDB2148	3075	FDB2200
2280	FDB151	2386	FDB673	2924	FDB2054	3082	FDB2196
2280	FDB389	2387	FDB404	2925	FDB2121	3083	FDB2212
2281	FDB569	2388	FDB607	2926	FDB2175	3086	FDB631
2282	FDB183	2389	FDB508	2927	FDB2055	3091	FDB605
2282	FDB338	2390	FDB2058	2958	FDB2097	3097	FDB2225
2283	FDB337	2391	FDB781	2959	FRP213		
2284	FDB383	2392	FDB591	2960	FDB2124	COBREQ	Ferodo
2284	FDB475	2393	FDB583	2961	FDB557	N-901	FDB311

BRAKE PADS X-REF

COMPETITORS - OE TO FERODO

COBREQ	Ferodo	EBC	Ferodo	EBC	Ferodo	EBC	Ferodo
N-906	FDB250	FA067/2	FDB731	FA137	FDB2016	FA218	FDB2007
N-909	FDB2086	FA068	FDB298	FA138	FDB485	FA218/2	FDB2123
N-911	FDB244	FA068	FDB299	FA140	FDB531	FA222	FDB2058
N-912	FDB538	FA069	FDB244	FA141	FDB508	FA226	FDB570
N-913	FDB583	FA069/2	FDB538	FA142	FDB570	FA228	FDB497
N-914	FDB694	FA069/3	FDB665	FA143	FDB496	FA228	FDB2305
N-915	FDB664	FA070	FDB277	FA145	FDB557	FA229	FDB2048
N-917	FDB495	FA071	FDB333	FA146	FDB569	FA230	FDB2133
N-930	FDB570	FA072	FDB334	FA147	FDB606	FA231	FDB2049
N-932	FDB2005	FA073	FDB132	FA151	FDB2192	FA232	FDB2054
N-934	FDB2006	FA076	FDB205	FA152	FDB659	FA233	FDB672
N-940	FDB631	FA077	FDB204	FA157	FDB607	FA234	FDB2101
		FA078	FDB335	FA158	FDB574	FA235	FDB2191
		FA080/2	FDB310	FA159	FDB2055	FA236	FDB557
DP (Dunlop) BRAKE	Ferodo	FA081	FDB311	FA160	FDB666	FA237	FDB2048
DP113	FDB496	FA083	FDB313	FA161	FDB338	FA239	FDB858
DP129	FDB2143	FA084	FDB381	FA162	FDB2194	FA244	FDB2042
DP506	FDB2281	FA084/3	FDB661	FA163	FDB529	FA245	FDB2018
DP509	FDB2255	FA085	FDB339	FA165	FDB631	FA249	FDB2036
DP514	FDB2262	FA086	FDB312	FA167	FDB706	FA251	FDB314
DP638	FDB2120	FA088	FDB337	FA169	FDB636	FA252	FDB605
DP962	FDB2210	FA092	FDB382	FA171	FDB736	FA254	FDB2111
DP987	FDB2251	FA093	FDB384	FA172	FDB737	FA255	FDB2037
		FA094	FDB352	FA173	FDB828	FA256	FDB438
EBC	Ferodo	FA095	FRP408	FA174	FDB754	FA256	FDB2060
EPFA263HH	FDB2167	FA098	FDB696	FA175	FRP415	FA256	FDB2146
FA013	FDB119	FA099	FDB436	FA177	FDB782	FA258	FDB2080
FA016	FDB342	FA101	FDB383	FA179	FDB781	FA259	FDB2049
FA016	FRP213	FA101	FDB475	FA180	FDB741	FA261	FDB2073
FA018	FDB108	FA102	FDB390	FA181	FDB2018	FA261HH	FDB2073
FA018	FDB148	FA103	FDB389	FA182	FDB637	FA261HH	FDB2098
FA021	FDB2014	FA104	FDB386	FA185	FDB892	FA264	FDB2190
FA022	FDB155	FA105	FDB411	FA186	FDB784	FA265	FDB2079
FA024/2	FDB185	FA106	FDB404	FA187	FDB533	FA266	FDB2074
FA027	FDB88	FA106/2	FDB673	FA188	FDB873	FA267	FDB2084
FA030	FDB182	FA107A	FRP410	FA188	FDB2144	FA268	FDB2062
FA032	FDB134	FA110	FDB437	FA189	FDB2002	FA270	FDB2121
FA033	FDB132	FA115	FRP405	FA190	FDB864	FA271	FDB2175
FA034	FDB177	FA116	FDB697	FA192	FDB2012	FA275	FDB2083
FA035	FDB150	FA118	FDB583	FA194	FDB677	FA283	FDB2085
FA036	FDB151	FA119	FDB2015	FA196	FDB664	FA291	FDB2103
FA038	FDB178	FA120	FDB592	FA196	FDB2225	FA294	FDB2124
FA041	FDB184	FA121	FDB462	FA197	FDB2087	FA296HH	FDB2114
FA045	FDB183	FA123	FDB449	FA199	FDB2003	FA297	FDB2129
FA047	FDB207	FA124	FDB452	FA200	FDB2001	FA298	FDB2090
FA047/3	FRP416	FA124/2	FDB663	FA201	FDB485	FA301	FDB2095
FA050	FDB213	FA125	FDB495	FA202	FDB497	FA302	FDB2110
FA051	FDB218	FA126	FDB498	FA203	FDB2113	FA303	FDB2109
FA054	FDB250	FA127	FDB624	FA208	FDB2005	FA304	FDB2102
FA060	FDB624	FA128	FDB2013	FA209	FDB2006	FA305	FDB2096
FA060	FDB694	FA129	FDB481	FA209/2	FDB2006	FA306	FDB2108
FA061	FDB247	FA130	FDB494	FA210	FDB847	FA307	FDB2148
FA062	FDB220	FA131	FDB539	FA213	FDB2005	FA314	FDB2176
FA063	FDB338	FA134	FDB499	FA214	FDB497	FA317	FDB2149
FA065	FDB217	FA135	FDB497	FA216/2	FDB2041	FA319/2	FDB2156
FA066	FDB299	FA136	FDB591	FA216/3	FDB2040	FA320	FDB2198
FA067	FDB314						

BRAKE PADS X-REF

COMPETITORS - OE TO FERODO

EBC	Ferodo	EBC	Ferodo	EBC	Ferodo	EBC	Ferodo
FA321	FDB2115	FA413	FDB2148	FA656	FDB2263	SFA418	FDB2186
FA322/4HH	FDB2120	FA414	FDB2149	FA662	FDB2283	SFA425	FDB2207
FA323	FDB2119	FA417/4	FDB2220	FA663	FDB2280	SFA430	FDB2208
FA324	FDB2105	FA418	FDB2186	FA664	FDB2314	SFA492	FDB2264
FA325	FDB2183	FA419	FDB2213	FA671	FDB2039	SFA498	FDB2248
FA335	FDB2125	FA423/4HH	FDB2085	FA678	FDB2279	SFA603	FDB2256
FA337	FDB694	FA424	FDB2036	FA679	FDB2294	SFA607	FDB2226
FA342	FDB2188	FA425	FDB2207	FA680	FDB2298	SFA607	FDB2254
FA343	FDB2143	FA426	FDB2185	FA681	FDB2277	SFA608	FDB2288
FA344	FDB2193	FA427	FDB2226	FA682	FDB2315	SFA625	FDB2282
FA345	FDB2145	FA428	FDB2235	FA683	FDB2316	SFA627	FDB2291
FA346	FDB2139	FA432	FDB2216	FA684	FDB2317	SFA628	FDB2292
FA347	FDB2158	FA433/4	FDB2244	FA685	FDB2318	SFA632	FDB2284
FA348	FDB2150	FA434	FDB2202	FA693	FDB2242	SFA652	FDB2297
FA349	FDB2080	FA435/4HH	FDB2166	FA694	FDB2290	SFA655	FDB2296
FA350	FDB2128	FA436	FDB2221	FA710	FDB2306	SFA719	FDB2304
FA351	FDB2127	FA438	FDB2039	FA716	FDB2313		
FA353	FDB2142	FA441	FDB2125	GPFA611HH	FDB2228	FRAS-LE	Ferodo
FA354	FDB2236	FA442	FDB2217	MXS405	FDB2245	PD/850	FDB250
FA355	FDB2141	FA443	FDB2231	Old FA113	FDB438	PD/852	FDB2086
FA356	FDB2140	FA444	FDB2230	Old FA139	FDB2001	PD/853	FDB583
FA357	FDB2157	FA445	FDB2233	Old FA168	FDB605	PD/854	FDB538
FA358	FDB2130	FA446	FDB2232	Old FA170	FDB2050	PD/855	FDB664
FA361	FDB2033	FA447	FDB2260	Old FA178	FDB625	PD/856	FDB244
FA363	FDB2039	FA450	FDB2219	old FA206	FDB889	PD/857	FDB694
FA366	FDB2163	FA452	FDB2263	Old FA246	FDB2050	PD/858	FDB311
FA367	FDB2162	FA454/4HH	FDB2240	SFA131/2	FDB783	PD/860	FDB495
FA367/2	FDB2206	FA456	FDB2320	SFA131/3	FDB672	PD/861	FDB631
FA368	FDB2165	FA457	FDB2250	SFA169	FDB636	PD/862	FDB2006
FA369/4HH	FDB2164	FA458	FDB2251	SFA186	FDB784	PD/863	FDB2005
FA372	FDB828	FA464	FDB2238	SFA193	FDB680	PD/864	FDB672
FA373	FDB2182	FA465	FDB2242	SFA193	FDB889	PD/865	FDB497
FA374	FDB2147	FA468	FDB2271	SFA233	FDB672	PD/866	FDB706
FA375	FDB2169	FA471	FDB2127	SFA234	FDB2101	PD/870	FDB570
FA377	FDB2184	FA475	FDB2276	SFA235	FDB2191		
FA379	FDB2178	FA488	FDB2253	SFA255	FDB2037	GALFER	Ferodo
FA380HH	FDB605	FA491	FDB2252	SFA257	FDB625	FD005	FDB119
FA381	FDB2179	FA495	FDB2267	SFA260	FDB2057	FD008	FDB342
FA382	FDB828	FA496	FDB2258	SFA264	FDB2190	FD012	FDB207
FA387	FDB2180	FA497	FDB2270	SFA268	FDB2062	FD013	FDB108
FA388	FDB2196	FA499/4HH	FDB2259	SFA281	FDB2075	FD013	FDB148
FA390	FDB2181	FA602	FDB2257	SFA283	FDB2085	FD014	FDB132
FA393	FDB2224	FA603	FDB2256	SFA301	FDB2095	FD016	FDB182
FA395	FDB2303	FA604/4HH	FDB2255	SFA306	FDB2108	FD017	FDB177
FA396	FDB2133	FA606	FDB2266	SFA319	FDB2126	FD019	FDB185
FA398	FDB2272	FA612	FDB2262	SFA321	FDB2115	FD025	FDB134
FA399	FDB2201	FA613	FDB2124	SFA323/2	FDB382	FD028	FDB205
FA400	FDB2097	FA617	FDB2273	SFA323/3	FDB2086	FD031	FDB213
FA401	FDB2197	FA618	FDB2274	SFA324	FDB2105	FD035	FDB150
FA405	FDB2245	FA629	FDB2275	SFA353	FDB2142	FD036	FDB155
FA407	FDB2050	FA630	FDB2265	SFA356	FDB2140	FD038	FDB178
FA408	FDB2200	FA636HH	FDB2281	SFA358	FDB2130	FD044	FDB204
FA409	FDB2210	FA640	FDB2299	SFA393	FDB2224	FD045	FDB183
FA410	FDB2195	FA642	FDB2301	SFA408	FDB2200	FD046	FDB218
FA411	FDB2132	FA643	FDB2018	SFA411	FDB2132	FD047	FDB217
FA412	FDB2173	FA645	FDB2302	SFA415	FDB2212	FD048	FDB694

BRAKE PADS X-REF

COMPETITORS - OE TO FERODO

GALFER	Ferodo	GALFER	Ferodo	GALFER	Ferodo	GALFER	Ferodo
FD051	FDB277	FD117	FDB631	FD190	FRP416	FD302	FDB2175
FD052	FDB298	FD118	FDB498	FD193	FDB2036	FD303	FDB2055
FD052	FDB299	FD119	FDB529	FD195	FDB2060	FD315	FDB2148
FD054	FDB244	FD120	FDB607	FD197	FDB2037	FD317	FDB2176
FD054	FDB538	FD121	FDB666	FD198	FDB2050	FD319	FDB2188
FD056	FDB311	FD124	FDB352	FD200	FDB2057	FD321	FDB2080
FD057	FDB337	FD125	FDB485	FD204	FDB2080	FD325	FDB2178
FD058	FDB333	FD126	FDB2001	FD205	FDB2073	FD326	FDB2181
FD059	FDB334	FD127	FDB591	FD206	FDB2062	FD329	FDB2150
FD060	FDB310	FD129	FDB737	FD207	FDB2075	FD331	FDB2158
FD062	FDB339	FD131	FDB2050	FD207	FDB2098	FD334	FDB2186
FD063	FDB382	FD132	FDB782	FD209	FDB404	FD336	FDB2184
FD064	FDB335	FD133	FDB706	FD214	FDB2083	FD339	FDB2179
FD065	FRP405	FD134	FDB754	FD218	FDB2084	FD340	FDB2180
FD066	FDB389	FD135	FDB828	FD219	FDB2079	FD341	FDB2201
FD067	FDB184	FD136	FDB636	FD219	FDB2114	FD342	FDB2224
FD068	FRP408	FD137	FDB736	FD220	FDB2074	FD343	FDB2207
FD069	FDB386	FD138	FDB2018	FD221	FDB2154	FD343	FDB2277
FD070	FDB673	FD140	FDB664	FD222	FDB2085	FD344	FDB2196
FD071	FDB436	FD140	FDB2225	FD223	FDB2109	FD345	FDB2212
FD072	FDB583	FD141	FDB741	FD224	FDB2127	FD352	FDB2200
FD073	FDB312	FD142	FDB781	FD225	FDB2103	FD355	FDB2208
FD074	FDB438	FD143	FDB637	FD228	FDB2090	FD359	FDB2213
FD075	FDB314	FD144	FDB672	FD232	FDB2081	FD363	FDB2221
FD076	FDB381	FD145	FDB2087	FD234	FDB2095	FD365	FDB2217
FD077	FDB247	FD147	FDB783	FD235	FDB2097	FD367	FDB2322
FD078	FDB389	FD148	FDB533	FD245	FDB2105	FD371	FDB2164
FD079	FDB475	FD149	FDB625	FD246	FDB2036	FD372	FDB2085
FD080	FDB411	FD152	FDB784	FD251	FDB2102	FD375	FDB2097
FD081	FDB437	FD152	FDB2100	FD252	FDB384	FD376	FDB2097
FD083	FDB390	FD153	FDB680	FD254	FDB2110	FD393	FDB2036
FD084	FDB697	FD155	FDB2002	FD259	FDB2143	FD393	FDB2238
FD085	FDB498	FD156	FDB873	FD260	FDB2126	FD399	FDB2226
FD086	FDB497	FD157	FDB864	FD261	FDB2096	FD399	FDB2254
FD087	FDB662	FD160	FRP415	FD262	FDB2120	FD400	FDB2086
FD089	FDB499	FD162	FDB677	FD263	FDB2115	FD401	FDB452
FD090	FDB481	FD163	FDB2194	FD265	FDB2157	FD402	FDB2145
FD091	FDB494	FD164	FDB892	FD266	FDB570	FD409	FDB2242
FD092	FDB495	FD165	FDB2005	FD267	FDB2111	FD412	FDB2108
FD093	FDB539	FD166	FDB2101	FD270	FDB2128	FD428	FDB2267
FD094	FDB313	FD167	FDB2012	FD271	FDB2125	FD437	FDB2255
FD095	FDB250	FD168	FDB2007	FD272	FDB2124	FD438	FDB2248
FD096	FDB462	FD169	FDB2003	FD275	FDB2141	FD439	FDB2256
FD097	FDB2015	FD170	FDB207	FD276	FDB2140	FD446	FDB2262
FD098	FDB592	FD171	FDB889	FD277	FDB2142	FD450	FDB2266
FD099	FDB557	FD172	FDB2006	FD278	FDB2139	FD456	FDB2162
FD100	FDB533	FD174	FDB2048	FD284	FDB2119	FD457	FDB2258
FD101	FDB606	FD175	FDB2191	FD286	FDB2162	FD475	FDB2265
FD103	FDB531	FD176	FDB2042	FD290	FDB2164	FD481	FDB2291
FD104	FDB508	FD177	FDB2133	FD291	FDB2165	FD483	FDB2292
FD107	FDB574	FD178	FDB605	FD295	FDB2156	FD503	FDB2290
FD109	FDB569	FD179	FDB2049	FD296	FDB2189	FD519	FDB2300
FD110	FDB496	FD181	FDB2171	FD298	FDB2169	FD526	FDB2304
FD111	FDB338	FD186	FDB2039	FD299	FDB661		
FD113	FDB2192	FD188	FDB2190	FD300	FDB2054	GOLD FREN	Ferodo
FD114	FDB659	FD189	FDB2058	FD301	FDB2121	001	FDB659

BRAKE PADS X-REF

COMPETITORS - OE TO FERODO

GOLD FREN	Ferodo	GOLD FREN	Ferodo	GOLD FREN	Ferodo	LUCAS/TRW	Ferodo
002	FDB497	137	FDB2057	293	FDB2142	MCB550	FDB404
003	FDB539	140	FDB2141	299	FDB2256	MCB551	FDB673
005	FDB314	141	FDB2042	302	FDB2248	MCB552	FDB694
009	FDB631	146	FDB2083	304	FDB2255	MCB554	FDB661
011	FDB312	147	FDB2085	305	FDB2266	MCB555	FDB314
013	FDB481	148	FDB2111	306	FDB2258	MCB556	FDB437
014	FDB664	150	FDB2090	311	FDB2275	MCB557	FDB438
014	FDB2225	152	FDB2074	324	FDB2079	MCB558	FDB2015
015	FDB337	165	FDB2126	328	FDB2265	MCB559	FDB449
017	FDB557	165	FDB2156	330	FDB2264	MCB560	FDB2013
019	FDB498	170	FDB2095	331	FDB2291	MCB561	FDB381
020	FDB531	174	FDB2190	332	FDB2087	MCB562	FDB462
021	FDB754	176	FDB2139	333	FDB2288	MCB563	FDB592
022	FDB570	177	FDB2120	334	FDB497	MCB564	FDB436
023	FDB2005	177	FDB2215	336	FDB2282	MCB567	FDB2014
024	FDB663	178	FDB2073	363	FDB2284	MCB568	FDB583
025	FDB462	178	FDB2098			MCB569	FDB481
030	FDB404	182	FDB2148	LUCAS/TRW	Ferodo	MCB571	FDB452
031	FDB2018	183	FDB2096	MCB17	FDB155	MCB572	FDB498
032	FDB574	186	FDB2115	MCB18	FDB88	MCB573	FDB494
037	FDB339	187	FDB2162	MCB19	FDB108	MCB574	FDB495
038	FDB207	188	FDB2119	MCB35	FDB119	MCB575	FDB539
039	FDB873	191	FDB2165	MCB501	FDB217	MCB576	FDB696
039	FDB2144	193	FDB2105	MCB503	FDB184	MCB578	FDB697
042	FDB313	194	FDB2124	MCB508	FDB213	MCB579	FDB499
047	FDB313	196	FDB2125	MCB511	FDB333	MCB582	FDB497
048	FDB781	200	FDB2164	MCB512	FDB244	MCB583	FDB2001
050	FDB244	207	FDB2158	MCB512	FDB665	MCB584	FDB662
064	FRP408	210	FDB2169	MCB515	FDB299	MCB585	FDB531
067	FDB386	211	FDB2128	MCB516	FDB298	MCB586	FDB508
070	FDB605	213	FDB2178	MCB517	FDB731	MCB587	FDB591
071	FDB672	213	FDB2204	MCB518	FDB334	MCB589	FDB2192
071	FDB783	214	FDB2181	MCB519	FDB313	MCB59	FDB218
081	FDB108	214	FDB2205	MCB521	FDB277	MCB590	FDB636
088	FDB631	221	FDB2143	MCB522	FDB313	MCB591	FDB569
093	FDB2012	230	FDB2184	MCB523	FDB314	MCB593	FDB533
098	FDB680	233	FDB2201	MCB524	FDB311	MCB594	FDB495
099	FDB2003	234	FDB2108	MCB525	FDB312	MCB595	FDB557
102	FDB2086	239	FDB2166	MCB527	FDB335	MCB597	FDB606
104	FDB2048	241	FDB2213	MCB531	FDB338	MCB598	FDB570
106	FDB2006	242	FDB2221	MCB532	FDB339	MCB599	FDB664
107	FDB889	246	FDB2217	MCB533	FDB204	MCB602	FDB574
115	FDB697	249	FDB2220	MCB534	FDB382	MCB611	FDB605
116	FDB2007	257	FDB2196	MCB535	FRP405	MCB612	FDB607
117	FDB2050	258	FDB2260	MCB536	FDB205	MCB615	FDB631
118	FDB2100	262	FDB2208	MCB539	FDB383	MCB617	FDB736
121	FRP405	263	FDB2207	MCB539	FDB475	MCB618	FDB529
124	FDB2049	264	FDB2238	MCB54	FDB182	MCB619	FDB2055
126	FDB2036	265	FDB2173	MCB540	FRP408	MCB622	FDB666
128	FDB2062	266	FDB2186	MCB541	FDB386	MCB623	FRP416
131	FDB2101	267	FDB2132	MCB542	FDB389	MCB624	FDB663
134	FDB2079	268	FDB2200	MCB543	FDB310	MCB625	FDB659
134	FDB2114	286	FDB2226	MCB544	FDB538	MCB626	FDB2016
135	FDB2073	286	FDB2254	MCB547	FDB390	MCB627	FDB737
135	FDB2075	287	FDB2212	MCB548	FDB352	MCB629	FDB706
136	FDB2191	292	FDB2039	MCB55	FDB183	MCB63	FDB134

BRAKE PADS X-REF

COMPETITORS - OE TO FERODO

LUCAS/TRW	Ferodo	LUCAS/TRW	Ferodo	LUCAS/TRW	Ferodo	LUCAS/TRW	Ferodo
MCB631	FDB2225	MCB706	FDB2085	MCB767	FDB2127	MCB97	FDB185
MCB633	FRP415	MCB707	FDB2039	MCB769	FDB2182	MCB99	FDB342
MCB634	FDB754	MCB708	FDB2081	MCB770	FDB2103		
MCB635	FDB847	MCB709	FDB2095	MCB771	FDB2186	NEWFREN	Ferodo
MCB640	FDB781	MCB710	FDB2090	MCB772	FDB2133	FD0005	FDB119
MCB642	FDB637	MCB711	FDB2097	MCB774	FDB2224	FD0008	FDB342
MCB643	FDB741	MCB712	FDB2096	MCB776	FDB2196	FD0012	FDB207
MCB644	FDB889	MCB713	FDB2102	MCB779	FDB2108	FD0013	FDB108
MCB646	FDB2194	MCB714	FDB2110	MCB780	FDB2201	FD0013	FDB108
MCB647	FDB625	MCB715	FDB2123	MCB781	FDB2210	FD0014	FDB132
MCB648	FDB2018	MCB719	FDB2129	MCB782	FDB2207	FD0016	FDB182
MCB650	FDB783	MCB72	FDB178	MCB784	FDB2221	FD0017	FDB177
MCB651	FDB784	MCB721	FDB2120	MCB785	FDB2221	FD0022	FDB151
MCB652	FDB782	MCB722	FDB2126	MCB786	FDB2208	FD0025	FDB134
MCB653	FDB2040	MCB723	FDB2149	MCB789	FDB2220	FD0028	FDB205
MCB656	FDB864	MCB724	FDB2148	MCB79	FDB132	FD0031	FDB213
MCB657	FDB828	MCB725	FDB2150	MCB790	FDB2166	FD0035	FDB150
MCB658	FDB2002	MCB726	FDB2105	MCB791	FDB2219	FD0036	FDB155
MCB659	FDB873	MCB727	FDB2115	MCB792	FDB2260	FD0038	FDB178
MCB660	FDB2036	MCB729	FDB2111	MCB793	FDB2245	FD0044	FDB204
MCB662	FDB2012	MCB73	FDB151	MCB794	FDB2244	FD0045	FDB183
MCB663	FDB2087	MCB731	FDB2156	MCB795	FDB2217	FD0046	FDB218
MCB664	FDB677	MCB732	FDB2141	MCB796	FDB2147	FD0047	FDB217
MCB665	FDB672	MCB733	FDB2140	MCB797	FDB2198	FD0048	FDB694
MCB666	FDB2003	MCB734	FDB677	MCB800	FDB2226	FD0051	FDB277
MCB668	FDB2054	MCB735	FDB2128	MCB801	FDB2231	FD0052	FDB299
MCB669	FDB892	MCB736	FDB2124	MCB802	FDB2230	FD0053	FDB298
MCB671	FDB2006	MCB737	FDB2158	MCB803	FDB2233	FD0054	FDB244
MCB672	FDB2005	MCB739	FDB2162	MCB804	FDB2232	FD0055	FDB220
MCB673	FDB2060	MCB740	FDB2157	MCB806	FDB2212	FD0058	FDB538
MCB677	FDB664	MCB741	FDB2163	MCB810	FDB2240	FD0062	FDB311
MCB678	FDB2058	MCB742	FDB2164	MCB812	FDB2238	FD0063	FDB310
MCB679	FDB2133	MCB743	FDB2165	MCB813	FDB2250	FD0065	FDB184
MCB68	FDB177	MCB744	FDB2142	MCB814	FDB2251	FD0066	FDB247
MCB680	FDB2050	MCB746	FDB2132	MCB815	FDB2228	FD0067	FDB382
MCB681	FDB2049	MCB747	FDB2145	MCB816	FDB2252	FD0068	FDB337
MCB682	FDB2048	MCB748	FDB2125	MCB817	FDB2253	FD0069	FDB696
MCB683	FDB2042	MCB749	FDB2146	MCB819	FDB2079	FD0071	FDB731
MCB684	FDB2190	MCB75	FDB207	MCB820	FDB2206	FD0072	FDB339
MCB685	FDB2119	MCB750	FDB2183	MCB821	FDB2254	FD0073	FDB314
MCB686	FDB2101	MCB751	FDB2173	MCB822	FDB312	FD0074	FDB436
MCB688	FDB2037	MCB752	FDB2178	MCB823	FDB2195	FD0075	FDB312
MCB691	FDB2111	MCB753	FDB2179	MCB828	FDB2259	FD0077	FDB384
MCB692	FDB2073	MCB754	FDB2180	MCB829	FDB2255	FD0078	FDB381
MCB693	FDB2075	MCB755	FDB2181	MCB830	FDB2248	FD0080	FDB250
MCB694	FDB2191	MCB756	FDB2193	MCB831	FDB2257	FD0082	FDB386
MCB695	FDB2057	MCB757	FDB2188	MCB833	FDB2256	FD0083	FDB389
MCB696	FDB680	MCB758	FDB2080	MCB834	FDB2266	FD0084	FDB665
MCB697	FDB2080	MCB759	FDB2169	MCB840	FDB2075	FD0085	FDB313
MCB699	FDB2083	MCB760	FDB2184	MCB841	FDB2258	FD0089	FDB411
MCB70	FDB150	MCB761	FDB2055	MCB842	FDB2262	FD0090	FDB475
MCB700	FDB2074	MCB762	FDB2121	MCB845	FDB570	FD0091	FDB438
MCB701	FDB2062	MCB763	FDB2175	MCB847	FDB2216	FD0092	FDB404
MCB702	FDB2084	MCB764	FDB570	MCB848	FDB2281	FD0093	FRP408
MCB703	FDB2114	MCB765	FDB384	MCB849	FDB2291	FD0094	FRP405
MCB704	FDB2098	MCB766	FDB2109	MCB873	FDB2292	FD0095	FDB673

BRAKE PADS X-REF

COMPETITORS - OE TO FERODO

NEWFREN	Ferodo	NEWFREN	Ferodo	NEWFREN	Ferodo	NEWFREN	Ferodo
FD0096	FDB592	FD0173	FDB625	FD0267	FDB2090	FD0355	FDB2169
FD0097	FDB583	FD0175	FDB636	FD0268	FDB2103	FD0356	FDB2173
FD0098	FDB697	FD0176	FDB637	FD0269	FDB2096	FD0361	FDB2144
FD0099	FDB698	FD0177	FDB662	FD0270	FDB847	FD0362	FDB2178
FD0100	FDB437	FD0178	FDB783	FD0271	FDB2095	FD0363	FDB2244
FD0102	FDB2015	FD0183	FDB781	FD0272	FDB2111	FD0364	FDB2181
FD0103	FDB624	FD0185	FDB741	FD0274	FDB2136	FD0365	FDB2186
FD0104	FDB449	FD0186	FDB2018	FD0277	FDB2102	FD0366	FDB2170
FD0105	FDB663	FD0188	FDB452	FD0278	FDB2014	FD0367	FDB2171
FD0106	FDB462	FD0189	FDB148	FD0279	FDB2054	FD0368	FDB2168
FD0106	FDB2113	FD0190	FDB605	FD0280	FDB2055	FD0369	FDB2167
FD0108	FDB481	FD0191	FDB666	FD0281	FDB677	FD0370	FDB2166
FD0110	FDB2013	FD0192	FDB672	FD0282	FDB2105	FD0371	FDB2163
FD0113	FDB499	FD0193	FDB892	FD0290	FDB2097	FD0372	FDB2183
FD0114	FDB539	FD0194	FDB784	FD0292	FDB2109	FD0374	FDB2188
FD0115	FDB498	FD0195	FDB677	FD0293	FDB2108	FD0376	FDB2182
FD0116	FDB494	FD0196	FDB680	FD0294	FDB2121	FD0378	FDB2200
FD0118	FRP410	FD0197	FDB889	FD0295	FDB2110	FD0379	FDB2185
FD0119	FDB390	FD0198	FDB858	FD0296	FDB2129	FD0380	FDB2201
FD0120	FDB495	FD0199	FDB873	FD0297	FDB2040	FD0381	FDB2189
FD0122	FDB497	FD0201	FDB864	FD0298	FDB2115	FD0383	FDB2184
FD0123	FDB661	FD0203	FDB2002	FD0299	FDB2041	FD0385	FDB2196
FD0124	FDB383	FD0204	FDB887	FD0300	FDB2079	FD0386	FDB2180
FD0129	FDB557	FD0205	FDB2003	FD0301	FDB2148	FD0387	FDB2179
FD0130	FDB664	FD0206	FDB2005	FD0304	FDB2119	FD0388	FDB2193
FD0131	FDB533	FD0207	FDB2012	FD0305	FDB2120	FD0389	FDB2202
FD0132	FDB570	FD0213	FDB2007	FD0309	FDB2175	FD0391	FDB2198
FD0134	FDB338	FD0216	FDB2006	FD0315	FDB2127	FD0394	FDB2207
FD0135	FDB591	FD0217	FDB2058	FD0316	FDB2126	FD0395	FDB2194
FD0136	FDB531	FD0219	FDB2190	FD0318	FDB2149	FD0396	FDB2208
FD0138	FDB508	FD0221	FDB2042	FD0319	FDB2124	FD0397	FDB2195
FD0139	FDB2192	FD0222	FDB2133	FD0320	FDB2125	FD0398	FDB2206
FD0140	FDB606	FD0223	FDB2191	FD0323	FDB2128	FD0399	FDB2197
FD0141	FDB496	FD0224	FDB2101	FD0324	FDB2130	FD0401	FDB2212
FD0142	FDB2107	FD0225	FDB2037	FD0325	FDB570	FD0402	FDB2213
FD0143	FDB574	FD0227	FDB2049	FD0326	FDB2132	FD0403	FDB2209
FD0144	FDB659	FD0228	FDB2048	FD0327	FDB2141	FD0404	FDB2216
FD0145	FDB2016	FD0229	FDB2039	FD0328	FDB2140	FD0405	FDB2210
FD0147	FDB569	FD0237	FDB2050	FD0329	FDB2139	FD0406	FDB2225
FD0149	FDB485	FD0238	FDB2060	FD0330	FDB2142	FD0407	FDB2217
FD0150	FDB2001	FD0246	FDB2036	FD0331	FDB2143	FD0409	FDB2204
FD0151	FDB185	FD0249	FDB2057	FD0334	FDB2147	FD0410	FDB2205
FD0153	FDB333	FD0251	FDB2062	FD0335	FDB2146	FD0411	FDB2219
FD0154	FDB334	FD0253	FDB2073	FD0336	FDB2154	FD0412	FDB2221
FD0155	FDB335	FD0254	FDB2098	FD0339	FDB2123	FD0413	FDB2215
FD0157	FDB352	FD0255	FDB2075	FD0340	FDB2122	FD0414	FDB2224
FD0158	FDB529	FD0256	FDB2074	FD0341	FDB2150	FD0415	FDB2260
FD0160	FRP416	FD0257	FDB2087	FD0343	FDB2153	FD0416	FDB2202
FD0162	FDB706	FD0258	FDB2114	FD0344	FDB2145	FD0417	FDB2226
FD0163	FDB631	FD0259	FDB2083	FD0345	FDB2156	FD0419	FDB2220
FD0164	FDB607	FD0261	FDB2084	FD0346	FDB2176	FD0422	FDB2288
FD0165	FDB828	FD0262	FDB2080	FD0348	FDB2165	FD0426	FDB2235
FD0167	FDB737	FD0263	FDB2081	FD0349	FDB2162	FD0427	FDB2231
FD0169	FDB736	FD0264	FDB2085	FD0351	FDB2158	FD0428	FDB2232
FD0171	FDB782	FD0265	FDB2086	FD0352	FDB2164	FD0428	FDB2233
FD0172	FDB754	FD0266	FDB2100	FD0354	FDB2157	FD0429	FDB2230

BRAKE PADS X-REF

COMPETITORS - OE TO FERODO

NEWFREN	Ferodo	SBS	Ferodo	SBS	Ferodo	SBS	Ferodo
FD0430	FDB2231	111	FDB636	199	FDB2206	555	FDB337
FD0430	FDB2232	114	FDB889	201	FDB2226	556	FDB338
FD0435	FDB2236	115	FDB625	201	FDB2254	557	FDB339
FD0436	FDB2251	117	FDB784	202	FDB2057	558	FDB382
FD0437	FDB2238	119	FDB2087	203	FDB384	559	FDB2107
FD0438	FDB2240	120	FDB677	204	FDB2248	559	FRP405
FD0441	FDB2252	123	FDB680	205	FDB2256	560	FDB205
FD0442	FDB2214	124	FDB2060	207	FDB2284	562	FDB381
FD0443	FDB2250	125	FDB2119	208	FDB2264	566	FRP408
FD0444	FDB2242	128	FDB2003	212	FDB2288	570	FDB386
FD0445	FDB2254	134	FDB631	214	FDB2322	571	FDB310
FD0446	FDB2253	138	FDB207	215	FDB2291	572	FDB538
FD0448	FDB2243	140	FDB2190	216	FDB2282	574	FDB624
FD0460	FDB2248	142	FDB2057	218	FDB2292	574	FDB694
FD0462	FDB2245	143	FDB680	218MS	FDB2292	575	FDB383
FD0464	FDB2257	145	FDB2062	222	FDB2296	575	FDB475
FD0466	FDB2255	146	FDB2085	223	FDB2297	576	FDB2014
FD0467	FDB2256	147	FDB2073	501	FDB119	577	FDB389
FD0470	FDB2258	147	FDB2075	505	FDB88	578	FDB390
FD0481	FDB2262	149	FDB2081	506	FDB108	579	FDB352
FD0486	FDB2264	151	FDB2018	506	FDB148	580	FDB411
FD0487	FDB2284	152	FDB2090	507	FDB177	581	FDB404
FD0489	FDB2291	153	FDB2095	508	FDB182	582	FDB673
FD0490	FDB2292	154	FDB2096	509	FDB134	583	FDB207
FD0491	FDB2259	155	FDB2083	510	FDB132	584	FDB661
FD0492	FDB2263	157	FDB2074	511	FDB150	585	FDB384
FD0492	FDB2270	158	FDB754	512	FDB151	586	FDB314
FD0494	FDB2268	158	FDB2130	513	FDB185	587	FDB437
FD0496	FDB2267	159	FDB2105	515	FDB178	588	FDB438
FD0497	FDB2266	161	FDB531	517	FDB182	589	FDB2015
FD0498	FDB2265	163	FDB497	519	FDB207	590	FDB449
FD0500	FDB2281	163	FDB2305	520	FDB155	591	FDB2013
FD0501	FDB2322	166	FDB2115	523	FDB342	592	FDB381
FD0502	FDB2275	167	FDB2128	526	FDB183	593	FDB462
FD0503	FDB2272	168	FDB677	528	FDB184	593	FDB2113
FD0504	FDB2271	169	FDB2126	530	FDB220	594	FDB592
FD0505	FDB2273	171	FDB2141	532	FDB213	595	FDB436
FD0506	FDB2274	174	FDB2086	533	FDB218	596	FDB583
FD0509	FDB2228	174	FDB2132	534	FDB217	597	FDB481
FD0510	FDB2277	177	FDB2142	536	FDB250	600	FDB452
FD0511	FDB2314	178	FDB2108	537	FDB333	601	FDB498
FD0513	FDB2276	180	FDB2169	539	FDB299	602	FDB494
FD0514	FDB2279	181	FDB2225	540	FDB298	603	FDB495
FD0515	FDB2280	182	FDB2173	541	FDB731	604	FDB539
FD0516	FDB2283	183	FDB570	542	FDB244	605	FDB696
FD0517	FDB2296	184	FDB570	542	FDB665	607	FDB697
FD0518	FDB2297	185	FDB2200	543	FDB334	608	FDB499
FD0519	FDB2282	187	FDB2186	544	FDB313	609	FDB485
FD0535	FDB2290	192	FDB2196	545	FDB247	611	FDB497
		193	FDB2212	546	FDB314	613	FDB662
		194	FDB2208	547	FDB277	614	FDB531
SBS	Ferodo	195	FDB2226	549	FDB335	615	FDB508
100	FDB250	195	FDB2254	550	FDB311	616	FDB591
101	FDB313	196	FDB2148	551	FDB312	618	FDB2192
102	FDB313	197	FDB497	552	FDB310	619	FDB636
105	FRP405	198	FDB605	554	FDB204	620	FDB569
108	FDB438						

BRAKE PADS X-REF

COMPETITORS - OE TO FERODO

SBS	Ferodo	SBS	Ferodo	SBS	Ferodo	SBS	Ferodo
622	FDB533	692	FDB314	772	FDB2115	839	FDB2217
623	FDB495	694	FDB892	773	FDB2128	840	FDB2219
624	FDB557	695	FDB2007	774	FDB677	841	FDB2260
626	FDB606	697	FDB680	775	FDB2141	842	FDB2245
627	FDB570	700	FDB664	776	FDB2140	843	FDB2244
630	FDB664	701	FDB2058	777	FDB2139	844	FDB2216
631	FDB574	702	FDB2133	778	FDB2124	845	FDB2228
632	FDB659	703	FDB2050	780	FDB2147	846	FDB2202
633	FDB631	704	FDB2049	781	FDB2119	847	FDB2226
634	FDB605	705	FDB2048	781	FDB2132	847	FDB2254
635	FDB607	706	FDB2042	782	FDB2158	849	FDB2230
638	FDB631	707	FDB2167	783	FDB2157	850	FDB2231
638	FDB2087	708	FDB2190	784	FDB2143	851	FDB2232
639	FDB605	710	FDB2101	786	FDB2142	852	FDB2233
640	FDB736	711	FDB2123	787	FDB2176	853	FDB2250
641	FDB529	712	FDB2037	788	FDB2164	854	FDB2251
642	FDB2055	713	FDB497	789	FDB2163	856	FDB2240
644	FDB2050	714	FDB557	790	FDB2162	858	FDB2238
645	FDB666	715	FDB2111	791	FDB2165	859	FDB2242
646	FRP416	716	FDB2055	792	FDB2108	860	FDB2079
647	FDB663	717	FDB2054	793	FDB2146	861	FDB2206
648	FDB659	721	FDB2073	794	FDB2183	862	FDB2253
649	FDB2016	722	FDB2075	795	FDB2145	864	FDB2252
650	FDB737	723	FDB2191	796	FDB2125	869	FDB2259
652	FDB706	725	FDB680	797	FDB2169	870	FDB2255
654	FDB2225	726	FDB2080	798	FDB2080	872	FDB2257
657	FDB754	728	FDB2083	799	FDB2193	877	FDB2266
658	FDB847	729	FDB2036	800	FDB2236	881	FDB2258
659	FDB2194	730	FDB2074	801	FDB2188	885	FDB2262
661	FRP410	731	FDB2062	802	FDB2109	889	FDB2278
662	FDB2041	732	FDB2171	803	FDB2127	892	FDB2281
663	FDB781	733	FDB2084	804	FDB2173	893	FDB2291
665	FDB637	734	FDB2114	805	FDB2166	895	FDB2267
666	FDB741	735	FDB2098	806	FDB2178	898	FDB2320
667	FDB889	736	FDB2098	806	FDB2204	900	FDB2265
669	FDB2001	740	FDB2085	807	FDB2179	901	FDB2260
670	FDB625	742	FDB2039	808	FDB2180	915	FDB2275
671	FDB2018	745	FDB2129	809	FDB2181	926	FDB2314
673	FDB783	746	FDB2102	809	FDB2205	931	FDB2280
674	FDB2006	747	FDB2090	810	FDB2184	932	FDB2283
675	FDB2005	748	FDB2095	812	FDB2200	940	FDB2294
676	FDB2036	749	FDB2096	813	FDB2182	949	FDB2306
678	FDB2040	750	FDB2097	814	FDB312	960	FDB2321
680	FDB784	752	FDB2110	815	FDB2103		
680	FDB2100	753	FDB754	818	FDB2186	VESRAH	Ferodo
681	FDB782	754	FDB2148	820	FDB2197	VD-102	FDB119
683	FDB864	755	FDB2121	821	FDB2201	VD-106	FDB119
684	FDB828	758	FDB2175	823	FDB2224	VD-108	FDB134
685	FDB2002	761	FDB2105	826	FDB2097	VD-112	FDB182
686	FDB873	762	FDB2120	828	FDB2196	VD-112/2	FDB182
686	FDB2144	763	FDB2198	830	FDB2210	VD-112/3	FDB182
687	FDB2012	765	FDB2111	833	FDB2213	VD-116	FDB134
688	FDB631	767	FDB2149	834	FDB2221	VD-117	FDB183
689	FDB677	769	FDB2156	835	FDB2307	VD-120	FDB250
690	FDB672	770	FDB2150	836	FDB2308	VD-123	FDB244
691	FDB2003	771	FDB680	838	FDB2220	VD-123	FDB665

BRAKE PADS X-REF

COMPETITORS - OE TO FERODO

VESRAH	Ferodo	VESRAH	Ferodo	VESRAH	Ferodo	VESRAH	Ferodo
VD-123/2	FDB538	VD-180	FDB2256	VD-276	FDB2149	VD-409	FDB132
VD-123/3	FDB665	VD-181	FDB2242	VD-277	FDB2217	VD-411	FDB132
VD-127	FDB661	VD-182	FDB2275	VD-278	FDB2232	VD-414	FDB132
VD-127/2	FDB381	VD-185	FDB2281	VD-278/2	FDB2230	VD-416	FDB338
VD-127/3	FDB381	VD-186	FDB2282	VD-279	FDB2233	VD-417	FDB132
VD-128	FDB381	VD-186/2	FDB2296	VD-279/2	FDB2231	VD-420	FDB299
VD-129	FDB310	VD-187	FDB2294	VD-280	FDB2219	VD-420/2	FDB298
VD-129/2	FDB310	VD-205	FDB177	VD-281	FDB2284	VD-421	FDB298
VD-131	FDB312	VD-215	FDB184	VD-282	FDB2238	VD-421	FDB299
VD-132	FDB665	VD-216	FDB247	VD-283	FDB2264	VD-423	FDB220
VD-134	FDB382	VD-221	FDB277	VD-289	FDB2280	VD-425	FDB314
VD-134	FDB2086	VD-228	FDB277	VD-290	FDB2283	VD-426	FDB339
VD-134/2	FDB382	VD-234	FDB2014	VD-291	FDB2290	VD-427	FDB481
VD-134/2	FDB2119	VD-235	FDB311	VD-305	FDB150	VD-428	FDB494
VD-134/3	FDB2086	VD-236	FDB337	VD-306	FDB151	VD-430	FDB508
VD-136	FDB2086	VD-239	FDB383	VD-306/2	FDB151	VD-432	FDB659
VD-139	FDB495	VD-239	FDB475	VD-318	FDB150	VD-432/2	FDB659
VD-139/2	FDB496	VD-239/2	FDB475	VD-320	FDB178	VD-433	FDB741
VD-141	FDB462	VD-240	FDB386	VD-322	FDB218	VD-434	FDB2012
VD-142	FDB462	VD-241	FDB411	VD-324	FDB217	VD-435	FDB2049
VD-143	FDB452	VD-242	FDB449	VD-327	FDB338	VD-436	FDB2111
VD-143/2	FDB663	VD-242/2	FDB449	VD-328	FDB390	VD-437	FDB2036
VD-144	FDB539	VD-242/3	FDB662	VD-329	FDB404	VD-438	FDB2080
VD-144	FDB783	VD-244	FDB2015	VD-329	FDB673	VD-439	FDB2124
VD-144/2	FDB672	VD-245	FDB583	VD-329/2	FDB673	VD-439/2	FDB2124
VD-144/3	FDB783	VD-246	FDB591	VD-331	FDB389	VD-440	FDB2110
VD-147	FDB531	VD-247	FDB636	VD-332	FDB2013	VD-441	FDB2188
VD-147/2	FDB2258	VD-248	FDB605	VD-335	FDB437	VD-442	FDB2080
VD-150	FDB2192	VD-249	FDB605	VD-340	FDB497	VD-443	FDB2158
VD-152	FDB438	VD-250	FDB631	VD-340/2	FDB497	VD-9000	FDB2125
VD-152	FDB2060	VD-250/2	FDB2087	VD-341	FDB2016	VD-9001	FDB2109
VD-154	FDB533	VD-251	FDB666	VD-342	FDB313	VD-9003	FDB2127
VD-156	FDB570	VD-252	FDB737	VD-343	FDB557	VD-9004	FDB2201
VD-156/3	FDB2225	VD-252/2	FDB2087	VD-343/2	FDB557	VD-9005	FDB2170
VD-161	FDB892	VD-253	FDB2194	VD-344	FDB574	VD-9006	FDB2183
VD-162	FDB625	VD-254	FDB2107	VD-344/4	FDB2163	VD-9007	FDB706
VD-163	FDB754	VD-254	FRP405	VD-345/2	FDB569	VD-9009	FDB2179
VD-164	FDB2002	VD-255	FDB781	VD-346	FDB384	VD-9010	FDB2180
VD-165	FDB2075	VD-256	FDB889	VD-347	FDB606	VD-9011	FDB2166
VD-165/2	FDB2073	VD-257	FDB637	VD-348	FDB607	VD-9012	FDB2190
VD-165/2	FDB2098	VD-257	FDB662	VD-349	FDB873	VD-9013	FDB2147
VD-165/3	FDB2073	VD-258	FDB864	VD-349	FDB2144	VD-9015	FDB677
VD-166	FDB2114	VD-260	FDB2003	VD-350	FDB2058	VD-9017	FDB2105
VD-166/2	FDB2079	VD-262	FDB2042	VD-351	FDB2133	VD-9018	FDB2146
VD-167	FDB2143	VD-263	FDB2083	VD-352	FDB2048	VD-9019	FDB2129
VD-168	FDB2139	VD-264	FDB2084	VD-353	FDB2085	VD-9022	FDB2097
VD-169	FDB2130	VD-265	FDB2083	VD-354	FDB2164	VD-9022	FDB2202
VD-170	FDB2181	VD-266	FDB2148	VD-355	FDB2178	VD-9024	FDB2236
VD-171	FDB2182	VD-268	FDB2150	VD-356	FDB2132	VD-9025	FDB2210
VD-172	FDB2196	VD-269	FDB2126	VD-357	FDB2173	VD-9026	FDB2184
VD-173	FDB2212	VD-269/2	FDB2156	VD-358	FDB2197	VD-9030	FDB2245
VD-174	FDB2221	VD-270	FDB2193	VD-359	FDB2213	VD-9031	FDB2260
VD-175	FDB2195	VD-271	FDB2162	VD-360	FDB2287	VD-9034	FDB2250
VD-177	FDB2169	VD-273	FDB2224	VD-392/2	FDB404	VD-9035	FDB2251
VD-178	FDB2253	VD-275	FDB2126	VD-404	FDB132	VD-9036	FDB2263
VD-179	FDB2259	VD-275	FDB2200	VD-408	FDB132	VD-9038	FDB2240

BRAKE PADS X-REF

COMPETITORS - OE TO FERODO

VESRAH	Ferodo	VESRAH	Ferodo	OEM - Harley	Ferodo	OEM Aprilia	Ferodo
VD-904	FDB88	VD-955	FDB2037	41300197	FDB2306	8133603	FDB2105
VD-9042	FDB2087	VD-956	FDB485			8133614	FDB2042
VD-9044	FDB2248	VD-957	FDB2001	OEM - Honda	Ferodo	8133725	FDB2146
VD-9045	FDB2254	VD-958	FDB2006	06435 K01 902	FDB2212	8133726	FDB2090
VD-9048	FDB2252	VD-959	FDB2050	06455 MKF D41	FDB2300	8133761	FDB438
VD-9058	FDB2262	VD-960	FDB2062	06455-KPN-E21	FDB2313	8133761	FDB2105
VD-9059	FDB2271	VD-961	FDB2167	06455-KRE-K01	FDB2319	8133798	FDB2060
VD-906	FDB342	VD-962	FDB2101			8133815	FDB2105
VD-906	FRP213	VD-963	FDB2121	OEM - Kawasaki	Ferodo	8133845	FDB2090
VD-9061	FDB2273	VD-964	FDB2074	43082-0131	FDB2079	8133886	FDB2120
VD-9062	FDB2274	VD-965	FDB2175	43082-0133	FDB2221	8133920	FDB2074
VD-9063	FDB2257	VD-967/2	FDB677			8133943	FDB2216
VD-9068	FDB2266	VD-969	FDB2007	OEM - Kymco	Ferodo	8133946	FDB2090
VD-907	FDB108	VD-969/2	FDB2123	43105-LGC6-305	FDB2304	8213192	FDB680
VD-9070	FDB2265	VD-971	FDB2202	45105-LKF5-305	FDB2322	8213197	FDB207
VD-908	FDB333	VD-972	FDB2102			8213197	FDB680
VD-909	FDB334	VD-974	FDB2090	OEM - Polaris	Ferodo	8213245	FDB680
VD-910	FDB155	VD-975	FDB847	2203318	FDB2320	8213318	FDB680
VD-911	FDB207	VD-976	FDB2095			8213460	FDB2095
VD-911/2	FRP416	VD-977	FDB2081	OEM - Yamaha	Ferodo	8213462	FDB2095
VD-911/4	FDB2081	VD-979	FDB2149	1CG-F5811-10	FDB2310	8213506	FDB2090
VD-912	FDB213	VD-980	FDB680	1SH-W0045-00	FDB2311	8213571	FDB680
VD-912	FDB218	VD-981	FDB2115	1XD 25805	FDB2301	8213577	FDB2090
VD-915	FDB185	VD-982	FDB782	1XD 25805 10	FDB2302	854972	FDB2245
VD-918	FDB335	VD-983	FDB2142			858200	FDB2005
VD-919	FDB352	VD-984	FDB2050	OEM Aprilia	Ferodo	9100788	FDB892
VD-920	FDB694	VD-986	FDB2120	00H04704141	FDB2074	9100797	FDB2162
VD-921	FDB698	VD-987	FDB2141	2B000214	FDB2265		
VD-924	FDB592	VD-988	FDB2140	811 3533	FDB2006	OEM Benelli	Ferodo
VD-925	FDB2107	VD-991	FDB2183	8113064	FDB680	R180263110000	FDB2120
VD-927	FDB529	VD-992	FDB2176	8113375	FDB828	R180400126000	FDB2120
VD-928	FDB205	VD-993	FDB2145	8113456	FDB782	R300000126000	FDB2042
VD-929	FDB529	VD-994	FDB2108	8113478	FDB706	R310000127000	FDB2074
VD-930	FDB696	VD-995	FDB2096	8113489	FDB2006	R43420091A0	FDB680
VD-932	FDB436	VD-996	FDB2191	8113538	FDB2005	R44420041A0	FDB680
VD-933	FDB204	VD-997	FDB2165	8113593	FDB2018	R44422001A	FDB2074
VD-934	FDB736	VD-998	FDB2198	8113595	FDB828		
VD-937	FDB697	VD-999	FDB2128	8113627	FDB2006	OEM Beta	Ferodo
VD-940	FDB2055			8113638	FDB498	007360718000	FDB2267
VD-941	FDB2050	OEM - Arctic Cat	Ferodo	8113638	FDB680	2525240000	FDB680
VD-942	FDB499	1436-420	FDB2303	8113644	FDB680	2525370000	FDB680
VD-943	FDB498			8113651	FDB207		
VD-944	FDB2040	OEM - BMW	Ferodo	8113662	FDB2081	OEM BMW	Ferodo
VD-944/2	FDB2041	34 11 8 405 104	FDB2321	8113663	FDB680	34 11 1 451 995	FDB108
VD-945	FRP408			8113678	FDB680	34 11 1 454 720	FDB108
VD-946	FRP405	OEM - Can-Am	Ferodo	8113720	FDB2042	34 11 1 454 724	FDB108
VD-947	FDB2018	00705601149	FDB2301	8113751	FDB2074	34 11 1 458 388	FDB108
VD-947	FDB2039	715900379	FDB2315	8113754	FDB2042	34 11 2 301 358	FDB155
VD-947/2	FDB2039	715900380	FDB2316	8113865	FDB438	34 11 2 301 360	FDB108
VD-947/3	FDB2039	715900381	FDB2317	8113869	FDB2090	34 11 2 310 494	FDB736
VD-948	FDB680	715900382	FDB2318	8113898	FDB2074	34 11 2 311 175	FDB736
VD-948/2	FDB680	715900386	FDB2315	8113972	FDB2120	34 11 2 314 512	FDB2050
VD-949	FDB784	715900387	FDB2316	8113988	FDB2006	34 11 2 314 545	FDB204
VD-949	FDB2100	75601150	FDB2302	8133516	FDB2018	34 11 2 314 546	FDB736
VD-950	FDB2054			8133539	FDB2090	34 11 2 331 173	FDB2050
VD-953	FDB2005	OEM - Harley	Ferodo	8133592	FDB2120	34 11 2 331 175	FDB736
		41300004	FDB2299				

BRAKE PADS X-REF

COMPETITORS - OE TO FERODO

OEM BMW	Ferodo	OEM Cagiva	Ferodo	OEM Harley	Ferodo	OEM Honda	Ferodo
34 11 2 333 045	FDB2050	8000 A6416	FDB2120	42850 06	FDB2210	06435 MBL D02	FDB2098
34 11 231 4996	FDB2050	8000 A7417	FDB2120	42850 06A	FDB2210	06435 MCA 006	FDB2098
34 11 7 651 958	FDB2006	8000 B1593	FDB2042	42850 06B	FDB2210	06435 MCC 006	FDB2073
34 11 7 655 687	FDB2050			42897 06	FDB2210	06435 MCH 006	FDB2098
34 11 7 655 898	FDB2124	OEM Derbi	Ferodo	42897 08	FDB2210	06435 MEE 016	FDB754
34 11 7 658 386	FDB2124	00D01 210221	FDB2107	43395 80	FDB334	06435 MEJ 006	FDB2079
34 11 7 660 448	FDB2125	00H04703141	FDB677	43957 86B	FDB485	06435 MEJ 016	FDB754
34 11 7 671 780	FDB2125	864342	FDB2242	43957 86D	FDB485	06435 MEJ 016	FDB2079
34 11 7 683 064	FDB2125	865527	FDB2242	43957 86E	FDB485	06435 MEL D21	FDB2221
34 11 7 690 169	FDB2124			440 63 83C	FDB352	06435 MEL D22	FDB2221
34 11 7 690 170	FDB2124	OEM Ducati	Ferodo	44005 78	FDB185	06435 MET 651	FDB2196
34 11 7 690 259	FDB2125	0370 39760	FDB108	44032 79	FDB333	06435 MFA D11	FDB2196
34 11 7 696 593	FDB2006	0377 39766	FDB108	44063 83A	FDB352	06435 MFA D12	FDB2196
34 11 7 697 086	FDB2006	0820 39666	FDB108	44063 83B	FDB352	06435 MFG D01	FDB754
34 11 7 705 216	FDB2006	613400201A	FDB2042	4406383	FDB352	06435 MFG D02	FDB754
34 11 7 717 309	FDB2018	61340071A	FDB207	44082 00	FDB2097	06435 MFN D01	FDB2253
34 11 8 540 956	FDB2265	61340081A	FDB207	44082 00C	FDB2202	06435 MGS D31	FDB754
34 11 8 548 028	FDB2265	61340121A	FDB2265	44082-08	FDB2250	06435 MT8 405	FDB665
34 21 1 236 221	FDB108	61340201A	FDB2042	44209 82	FDB335	06435-KZZ-901	FDB2275
34 21 2 314 997AE	FDB2039	61340211A	FDB2074	44209 87B	FDB2001	06451 HPO A01	FDB2195
34 21 2 330 633	FDB2039	61340211B	FDB2042	44209 87C	FDB2001	06455 GAV 405	FDB2060
34 21 2 332 988	FDB108	61340281A	FDB207	44213 87	FDB2001	06455 GBF J01	FDB250
34 21 2 332 988	FDB2039	61340301A	FDB2120	46363-11	FDB2250	06455 GBM 750	FDB680
34 21 2 333 337	FDB2102	61340311A	FDB207	46721-06	FDB2202	06455 GBY 910	FDB680
34 21 2 335 465	FDB2039	61340381A	FDB2074			06455 GCS 006	FDB2119
34 21 2 345 449	FDB2005	61340411A	FDB2042	OEM Honda	Ferodo	06455 GCS 016	FDB2119
34 21 7 657 025	FDB108	61340541A	FDB207	06435 MZ0 006	FDB664	06455 KBS W00	FDB2060
34 21 7 657 492	FDB2102	61340611A	FDB2042	06435 MZ0 760	FDB664	06455 KCZ 000	FDB892
34 21 7 660 281	FDB2039	61340721A	FDB2018	06435 GCM 902	FDB2101	06455 KEB 900	FDB631
34 21 7 664 983	FDB2005	61340731A	FDB2074	06435 HN8 006	FDB2182	06455 KEB 901	FDB631
34 21 7 671 881	FDB2039	61340751A	FDB2006	06435 HN8 016	FDB2182	06455 KFG 016	FDB2073
34 21 7 680 375	FDB2102	61340761A	FDB2005	06435 KCZ 000	FDB539	06455 KFG 631	FDB2073
34 21 7 690 262	FDB108	61341021A	FDB2265	06435 KCZ 010	FDB539	06455 KFG 641	FDB2075
34 21 7 717 324	FDB2165	61370721A	FDB2006	06435 KFK 006	FDB754	06455 KFG 642	FDB2075
34 21 7 724 609	FDB2006			06435 KFK 016	FDB754	06455 KPB 406	FDB2073
34 21 8 534 821	FDB2006	OEM Gilera	Ferodo	06435 KPB 016	FDB2130	06455 KPB 416	FDB2073
341 12345 445	FDB2006	494097	FDB2057	06435 KPB 026	FDB2130	06455 KPP 901	FDB2169
		497396	FDB2018	06435 KPC 641	FDB2143	06455 KPP 902	FDB2169
		498408	FDB680	06435 KPC 642	FDB2143	06455 KSE 006	FDB381
OEM Brembo	Ferodo	647074	FDB2018	06435 KPP 901	FDB2143	06455 KSV J04	FDB2196
07.6708.22	FDB2042	647078	FDB2142	06435 KPP 902	FDB2143	06455 KVV 911	FDB2282
		647170	FDB2057	06435 KRJ 791	FDB2212	06455 KW6 843	FDB2087
OEM Buell	Ferodo	647171	FDB680	06435 KRN 711	FDB2139	06455 KW6 844	FDB2087
H0300 1AMA	FDB2240	647172	FDB680	06435 KRN 712	FDB2139	06455 KWB 601	FDB2282
H0300-02A8	FDB2145			06435 KT7 405	FDB531	06455 KWW C51	FDB2282
		OEM Harley	Ferodo	06435 KT7 415	FDB531	06455 MAA 405	FDB570
OEM Cagiva	Ferodo	41300102	FDB2114	06435 KTW 901	FDB2212	06455 MAA 415	FDB570
8000 45453	FDB592	41852 08	FDB2210	06435 KYJ 901	FDB2258	06455 MAB 405	FDB664
8000 46147	FDB207	41854 08	FDB2210	06435 KZ4 J41	FDB2139	06455 MAH 405	FDB570
8000 59214	FDB529	42029 07	FDB2180	06435 MAK 003	FDB2005	06455 MAK 000	FDB2006
8000 66785	FDB631	42298 08	FDB2251	06435 MAT 006	FDB2075	06455 MAK 003	FDB2006
8000 66796	FDB663	42739 08	FDB2079	06435 MAT 006	FDB2098	06455 MAL G01	FDB570
8000 67127	FDB784	42831 04	FDB2179	06435 MAT 016	FDB2075	06455 MAL G02	FDB570
8000 68794	FDB207	42831 04A	FDB2179	06435 MAT 016	FDB2098	06455 MAS 305	FDB533
8000 88482	FDB663	42836 04	FDB2180	06435 MBL D00	FDB2098	06455 MAS E01	FDB2079
8000 95280	FDB2074	428490 6A	FDB2210	06435 MBL D01	FDB2098	06455 MAT 006	FDB2073
8000 95542	FDB2042						

BRAKE PADS X-REF

COMPETITORS - OE TO FERODO

OEM Honda	Ferodo	OEM Honda	Ferodo	OEM Honda	Ferodo	OEM Kawasaki	Ferodo
06455 MAT E21	FDB2098	06455-KWN-641	FDB2256	45105 MW0 415	FDB533	43082 1008	FDB298
06455 MAT E22	FDB2098	06455-KWN-931	FDB2256	45105 MW3 671	FDB570	43082 1025	FDB298
06455 MAW 621	FDB664	06455-KZL-861	FDB2256	45105 MY6 405	FDB892	43082 1030	FDB339
06455 MAY 000	FDB892	06455-MV4-405	FDB570	45105 MY6 415	FDB892	43082 1062	FDB339
06455 MBB 006	FDB533	06455-MZ2-415	FDB2002	45105-KZ1-405	FDB892	43082 1065	FDB313
06455 MBB 016	FDB533	06455MFAD12	FDB2098	45106 ML7 922	FDB570	43082 1066	FDB381
06455 MBG 006	FDB2098	06456 MCA 006	FDB2098	45112 GC4 601	FDB250	43082 1072	FDB494
06455 MBK 751	FDB570	06456 MCA 016	FDB2098	6455-MGE-006	FDB2259	43082 1080	FDB339
06455 MBK 752	FDB570	06456 MCC 006	FDB2098	K00979315	FDB2268	43082 1082	FDB381
06455 MBT 611	FDB2098	43105 KZ1 405	FDB539			43082 1089	FDB497
06455 MBT 612	FDB2098	43105 KZ1 415	FDB539	OEM Kawasaki	Ferodo	43082 1090	FDB659
06455 MBT D51	FDB2196	43105 MB6 018	FDB665	43050 1064	FDB314	43082 1096	FDB314
06455 MBT D52	FDB2196	43105 MJ4 007	FDB244	43050 1288	FDB151	43082 1098	FDB338
06455 MBW 006	FDB2079	43105 MJ4 305	FDB244	43082 0002	FDB2158	43082 1099	FDB497
06455 MBW E11	FDB2079	43105 MJ6 004	FDB244	43082 0004	FDB2012	43082 1103	FDB338
06455 MBW E12	FDB2079	43105 MJ6 007	FDB244	43082 0006	FDB2162	43082 1112	FDB741
06455 MCF 006	FDB2079	43105 ML7 923	FDB664	43082 0009	FDB2048	43082 1114	FDB481
06455 MCF 016	FDB2079	43105 MR7 027	FDB496	43082 0010	FDB2049	43082 1116	FDB314
06455 MCK A01	FDB570	43105 MT3 007	FDB2075	43082 0014	FDB574	43082 1117	FDB497
06455 MCK A02	FDB570	43105 MT8 008	FDB665	43082 0016	FDB574	43082 1118	FDB659
06455 MCS G01	FDB2196	43105 MV9 008	FDB754	43082 0019	FDB574	43082 1123	FDB481
06455 MCS G02	FDB2196	43105 MW0 405	FDB754	43082 0021	FDB2164	43082 1125	FDB508
06455 MCT 691	FDB2075	43105 MW0 415	FDB754	43082 0025	FDB574	43082 1130	FDB741
06455 MCT 692	FDB2075	43105 MY1 405	FDB531	43082 0030	FDB574	43082 1131	FDB659
06455 MCW H01	FDB2196	43105 MY7 405	FDB664	43082 0031	FDB2164	43082 1134	FDB481
06455 MCW H02	FDB2196	43106 ML7 923	FDB664	43082 0043	FDB381	43082 1137	FDB659
06455 MCZ 006	FDB533	43106 MV9 008	FDB754	43082 0048	FDB2162	43082 1139	FDB481
06455 MCZ 016	FDB533	43211 431 305	FDB134	43082 0049	FDB892	43082 1142	FDB574
06455 MEA 671	FDB570	45105 390 305	FDB119	43082 0050	FDB2048	43082 1149	FDB892
06455 MEA 672	FDB570	45105 390 305	FDB182	43082 0051	FDB2048	43082 1151	FDB659
06455 MEH 006	FDB2196	45105 GBF 405	FDB250	43082 0052	FDB2049	43082 1152	FDB892
06455 MEL 013	FDB2181	45105 GC4 603	FDB250	43082 0053	FDB2220	43082 1157	FDB2012
06455 MEL D22	FDB2181	45105 HMA 000A	FDB2141	43082 0055	FDB2111	43082 1160	FDB2012
06455 MJP G51	FDB2294	45105 KA3 731	FDB382	43082 0058	FDB2164	43082 1162	FDB574
06455 MJP G52	FDB2294	45105 KBS 405	FDB2060	43082 0060	FDB497	43082 1163	FDB314
06455 MKH D01	FDB2294	45105 KFA6 305	FDB2096	43082 0061	FDB2048	43082 1163	FDB2013
06455 MR4 405	FDB570	45105 KKC4 305	FDB2141	43082 0062	FDB2049	43082 1167	FDB339
06455 MR4 415	FDB570	45105 KL8 405	FDB538	43082 0068	FDB2012	43082 1169	FDB574
06455 MS9 405	FDB570	45105 KR3 014	FDB312	43082 0071	FDB2220	43082 1171	FDB2012
06455 MT8 305	FDB663	45105 KT0 405	FDB892	43082 0072	FDB2220	43082 1172	FDB892
06455 MT8 405	FDB663	45105 KW3 405	FDB495	43082 0073	FDB754	43082 1173	FDB539
06455 MV4 405	FDB570	45105 KW3 681	FDB495	43082 0078	FDB2080	43082 1177	FDB2048
06455 MW3 405	FDB570	45105 KZ1 405	FDB495	43082 0079	FDB570	43082 1178	FDB2049
06455 MW3 415	FDB570	45105 MA5 305	FDB183	43082 0081	FDB631	43082 1179	FDB873
06455 MW4 405	FDB858	45105 MA6 004	FDB310	43082 0090	FDB539	43082 1180	FDB338
06455 MY1 405	FDB892	45105 MA6 007	FDB310	43082 0091	FDB2178	43082 1181	FDB2036
06455 MY5 731	FDB2006	45105 MC7 004	FDB244	43082 0095	FDB2087	43082 1182	FDB338
06455 MZ0 760	FDB570	45105 MC7 024	FDB244	43082 0104	FDB2220	43082 1187	FDB2048
06455 MZ1 405	FDB2002	45105 ML7 405	FDB570	43082 0105	FDB2049	43082 1189	FDB481
06455 MZ2 405	FDB2002	45105 ML7 922	FDB570	43082 0150	FDB570	43082 1190	FDB2012
06455-GFM-D31	FDB2256	45105 MM9 781	FDB244	43082 0151	FDB2258	43082 1193	FDB892
06455-K20-911	FDB2256	45105 MR4 901	FDB570	43082 0175	FDB631	43082 1194	FDB339
06455-K29-D01	FDB2256	45105 MS6 901	FDB452	43082 1001	FDB132	43082 1196	FDB2080
06455-KVB-T01	FDB2289	45105 MT8 008	FDB663	43082 1002	FDB220	43082 1199	FDB873
06455-KVB-TC1	FDB2289	45105 MV1 008	FDB462	43082 1005	FDB132	43082 1200	FDB338
06455-KVY-911	FDB2289	45105 MV1 405	FDB462	43082 1007	FDB299	43082 1205	FDB381

BRAKE PADS X-REF

COMPETITORS - OE TO FERODO

OEM Kawasaki	Ferodo	OEM KTM	Ferodo	OEM Moto Guzzi	Ferodo	OEM Polaris	Ferodo
43082 1209	FDB314	54613309300	FDB2005	18654660	FDB204	2200456	FDB2054
43082 1212	FDB250	54813090000	FDB2165	19654600	FDB207	2201093	FDB2121
43082 1213	FDB2012	54813090100	FDB2165	19654601	FDB207	2201871	FDB2176
43082 1217	FDB2125	54813090200	FDB2165	27654610	FDB207	2202412	FDB2055
43082 1218	FDB892	54813090300	FDB2165	276546100	FDB207	2205949	FDB2263
43082 1223	FDB2048	58413030000	FDB2018	30654625	FDB2018	2206231	FDB2298
43082 1224	FDB873	58413130000	FDB2042	30654626	FDB2006		
43082 1226	FDB2049	58713030000	FDB2042	30654630	FDB531	OEM Suzuki	Ferodo
43082 1227	FDB873	59413030000	FDB2244	31654665	FDB207	59100 03860	FDB2042
43082 1228	FDB539	5DSF581100	FDB2018	31654681	FDB2074	59100 05820	FDB631
43082 1229	FDB313	60013016000	FDB2018	316546810	FDB2074	59100 05830	FDB497
43082 1230	FDB873	60013030000	FDB2006	326546100	FDB2042	59100 09860	FDB2308
43082 1232	FDB2049	61013019000	FDB2120	36139666	FDB207	59100 09870	FDB2307
43082 1234	FDB2048	61013030000	FDB2120	3654600	FDB2006	59100 10810	FDB389
43082 1235	FDB2049	61013030100	FDB2120	56546300	FDB2018	59100 18850	FDB2164
43082 1237	FDB2049	69013090000	FDB2074	61654630	FDB108	59100 19820	FDB569
43082 1238	FDB2087	75013090000	FDB2005			59100 20820	FDB569
43082 1241	FDB381	77013020000	FDB2018	OEM MV Agusta	Ferodo	59100 23830	FDB2158
43082 1242	FDB2110	90113030000	FDB2266	8000 82748	FDB2198	59100 26810	FDB481
43082 1247	FDB892			8000 94024	FDB2036	59100 26820	FDB404
43082 1248	FDB2049	OEM Kymco	Ferodo	8000 B1421	FDB2166	59100 29820	FDB2178
43082 1250	FDB873	143071	FDB2248	8000B9025	FDB2265	59100 29840	FDB2158
43082 1251	FDB873	143289	FDB2248			59100 29850	FDB2178
43082 1252	FDB873	145285	FDB2256	OEM MZ	Ferodo	59100 31850	FDB2308
43082 1253	FDB873	156175	FDB2254	9021035000	FDB207	59100 31860	FDB2307
43082 1255	FDB2188	43105 HMA0 00A	FDB2140	9022001000	FDB782	59100 33850	FDB2049
43082 1257	FDB338	43105 KKC49 000	FDB2140	9022031000	FDB828	59100 33870	FDB2049
43082 1259	FDB873	43105 LBA2 305	FDB2225			59100 33880	FDB2049
43082 1260	FDB2049	43105 LBA2 305	FDB2288	OEM Norton	Ferodo	59100 35830	FDB574
43082 1264	FDB2049	43105 LDH1 E00	FDB2087	06 6005	FDB88	59100 35850	FDB574
43082 1266	FDB892	43105 LDH1 E00	FDB2254			59100 35880	FDB574
43082 1267	FDB539	43105 LEA7 305	FDB2248	OEM Piaggio	Ferodo	59100 38820	FDB389
43082 1272	FDB873	43105 LKF5 305	FDB2288	494628	FDB677	59100 45B90	FDB569
43082 1274	FDB873	43105 LKG2 305	FDB2248	497002	FDB2115	59100 47890	FDB2178
43082 1286	FDB892	43105-ALD9-305	FDB2087	497072	FDB2142	59100 5880	FDB574
43082 1290	FDB2158	43105-LDH-E00	FDB2254	497394	FDB2074	59100-34880-000	FDB2287
43082 1292	FDB539	43105-LEA7-305	FDB2226	647073	FDB2057	59101 03810	FDB2196
43082 1293	FDB2164	43150 LEA5 306	FDB2087	647076	FDB2074	59101 03820	FDB2196
K43082 0042	FDB2110	45105 H7C 000A	FDB2096	647077	FDB2074	59101 33820	FDB2049
K43082 1241	FDB381	45105 KCE3 050M2	FDB2087	647078	FDB2142	59101 33830	FDB2049
K43082 1242	FDB2110	45105 KECE 305	FDB2087	647157	FDB2057	59101 33880	FDB2049
		45105 LEJ2 305	FDB2096	647161	FDB2115	59101 35810	FDB574
		45105-ACC1-305	FDB2256	647171	FDB2096	59102 33810	FDB2049
OEM KTM	Ferodo	45106 KKD6 E00	FDB497	647400	FDB2207	59102 33860	FDB2049
45113030000	FDB2183	45150 LLB5 305	FDB2087	651253	FDB2142	59130 04A10	FDB390
46013090000	FDB694	45200 KHC4 900NJA	FDB2087	666935	FDB2105	59130 19C00	FDB569
46113030000	FDB2157	45200 KKD6 E90NJA	FDB2087	CM068308	FDB2142	59130 30B00	FDB389
47013030000	FDB2262			CM076101	FDB2057	59130 32C20	FDB574
47013090300	FDB2257	OEM Malagutti	Ferodo	CM076701	FDB2057	59130 36A01	FDB437
50313030000	FDB2018	11933400	FDB436	CM077902	FDB2018	59130 38B10	FDB389
50313030100	FDB2005	11943900	FDB680	I494096	FDB2057	59130 46E00	FDB873
50313030200	FDB2018	11950200	FDB680	I494097	FDB2057	59300 03860	FDB313
50313030300	FDB2018			I497417	FDB313	59300 03880	FDB2133
50313090000	FDB2005	OEM Moto Guzzi	Ferodo	I498414	FDB784	59300 09820	FDB680
54613209044	FDB2018	1654630	FDB2042	I498846	FDB2037	59300 13830	FDB892
54613209244	FDB2018	16546300	FDB2042			59300 13860	FDB892
54613309200	FDB2005			OEM Polaris	Ferodo		
				1911228	FDB2263		

BRAKE PADS X-REF

COMPETITORS - OE TO FERODO

OEM Suzuki	Ferodo	OEM Suzuki	Ferodo	OEM Sym	Ferodo	OEM Yamaha	Ferodo
59300 14870	FDB2085	69100 10820	FDB2163	43105-HMA-000A	FDB2226	1WD 25806 00	FDB2283
59300 14880	FDB2085	69100 10840	FDB2173	43108 HMA 000A	FDB2140	20S-W0046-00	FDB531
59300 17811	FDB557	69100 12B10	FDB607	43108-HMA-000A	FDB2226	23W W0045 00	FDB277
59300 21820	FDB570	69100 14840	FDB2086	43108H9A000A	FDB2096	26H W0045 01	FDB337
59300 21840	FDB570	69100 14850	FDB2086	43140 L4A 300	FDB2292	29L W0046 00	FDB337
59300 21850	FDB570	69100 15820	FDB2213	45100 A3B 000	FDB2192	29L W0046 01	FDB337
59300 24830	FDB404	69100 15830	FDB2213	45100 A3B 600	FDB2192	29LW004510	FDB311
59300 24830	FDB673	69100 16851	FDB754	45100 A7E 000	FDB2192	2BM-F5805-00	FDB2290
59300 26830	FDB497	69100 18810	FDB2111	45105 G22 000AC	FDB2190	2C0 W0045 00	FDB605
59300 27810	FDB497	69100 20810	FDB338	45105 G229 00A	FDB2190	2C8 W0045 00	FDB2018
59300 27830	FDB497	69100 21820	FDB338	45105 GM9 743A	FDB2192	2CM-F5805-00	FDB2297
59300 27850	FDB497	69100 22830	FDB508	45105 H3A 000A	FDB2108	2CM-F5805-10	FDB2296
59300 27860	FDB497	69100 31820	FDB631	45105 H3A 900A	FDB2108	2CM-F5806-00	FDB2143
59300 27870	FDB497	69100 31830	FDB2058	45105 HKF 000A	FDB2190	2CR 25806 0000	FDB2221
59300 29820	FDB384	69100 32830	FDB659	45105 T6R 000A	FDB2190	2DLF58110000	FDB2279
59300 33860	FDB481	69100 34860	FDB338	45105 TFA 000A	FDB2101	2DMF58110000	FDB2225
59300 33890	FDB873	69100 35810	FDB2162	45130 L4A 300	FDB2291	2DP-F5805-00	FDB2290
59300 34830	FDB574	69100 36820	FDB539	45135 L4A 300	FDB2291	2G2 W0045 00	FDB184
59300 35810	FDB680	69100 36840	FDB539			2HF W0046 00	FDB2015
59300 36850	FDB892	69100 36850	FDB539	OEM Triumph	Ferodo	2HH W0045 00	FDB411
59300 36860	FDB892	69100 36850	FDB2162	2020071T0301	FDB631	2S3 W0046 00	FDB2156
59300 36870	FDB892	69100 36860	FDB539	2020072T0301	FDB497	2UJ W0045 01	FDB311
59300 36880	FDB892	69100 37830	FDB539	2020073T0301	FDB557	2VW F0047 00	FDB499
59300 36890	FDB892	69100 37840	FDB539	2025016	FDB531	31A W0046 00	FDB337
59300 38810	FDB218	69100 38820	FDB389	T2020077	FDB664	32D W0045 00	FDB892
59300 46840	FDB873	69100 38840	FDB389	T2020211	FDB864	34X W0046 01	FDB383
59300 47880	FDB178	69100 40820	FDB2111	T2020245	FDB557	34X W0046 02	FDB383
59300 49850	FDB217	69100 40840	FDB2111	T2020537	FDB570	36M W0045 02	FDB666
59301 03820	FDB2080	69100 43820	FDB659	T2020555	FDB631	3BN W0045 01	FDB383
59301 33820	FDB2048	69100 43841	FDB659	T2020560	FDB631	3D6 F5811 00	FDB2128
59301 33830	FDB2048	69100 43851	FDB659	T2020602	FDB531	3D7 W0045 10	FDB570
59301 33870	FDB873	69100 43860	FDB659	T2020691	FDB2006	3GM W0045 01	FDB666
59301 33890	FDB873	69100 44860	FDB607	T2021221	FDB2252	3GM W0045 02	FDB666
59301 36810	FDB892	69100 47820	FDB2111	T2024901	FDB2005	3GM W0045 03	FDB662
59301 45860	FDB481	69101 03810	FDB2148			3GM W0045 60	FDB637
59302 33810	FDB2048	69101 05820	FDB338	OEM Yamaha	Ferodo	3JB W0045 00	FDB591
59302 33830	FDB2048	69101 05850	FDB338	11D F5811 00	FDB2018	3JD W0045 00	FDB497
59302 33880	FDB2048	69101 44810	FDB2213	17C W0045 00	FDB2284	3JD W0046 00	FDB661
59302 33890	FDB2048	69101 44820	FDB2213	1B7 W0045 00	FDB2003	3LD W0045 10	FDB631
59302 45830	FDB150	69101 44830	FDB2213	1B9 W0045 00	FDB2018	3LD W0046 01	FDB631
59330 38300	FDB218	69101 44840	FDB2162	1C3 W0046 10	FDB2162	3LP W0045 00	FDB781
59330 45260	FDB218	69101 44850	FDB754	1C3 W0046 50	FDB2162	3P6 W0045 00	FDB2085
69100 01810	FDB2016	69101 45850XNA	FDB151	1C3 W0046 80	FDB2162	3P6 W0046 50	FDB2156
69100 01870	FDB2049	69101-44850	FDB2258	1C3 W0046 B0	FDB2162	3SH F5811 20	FDB207
69100 02821	FDB313	69130 21E00	FDB338	1D2 W0045 00	FDB2042	3SP W0045 00	FDB497
69100 02822	FDB313	69130 26D00	FDB569	1D4 F5742 00	FDB659	3SP W0046 00	FDB659
69100 03880	FDB2197	69130 34C00	FDB338	1D5 F5811 00	FDB2018	3TB W0045 00	FDB737
69100 03890	FDB2148	69130 38B10	FDB389	1D7 W0046 00	FDB2156	3TC W0045 00	FDB557
69100 04820	FDB754	69130 45C00	FDB338	1D7W004500	FDB605	3TJ W0045 00	FDB605
69100 05830	FDB338	69130 48B00	FDB338	1FK W0046 01	FDB337	3TJ W0046 00	FDB386
69100 05850	FDB338	69140 19A01	FDB661	1FK W0046 02	FDB337	3UN W0045 00	FDB2015
69100 05860	FDB338	69140 26C00	FDB661	1J3 2000 013	FDB177	3XF W0045 50	FDB337
69100 05870	FDB338	69140 27C00	FDB659	1LN W0045 00	FDB411	3XJ W0046 00	FDB659
69100 05890	FDB338	69140 27C10	FDB659	1LR W0046 00	FDB2015	3XP W0046 00	FDB383
69100 06830	FDB754	69140 28C00	FDB659	1S6 W0045 00	FDB570	3XP W0046 00	FDB659
69100 07810	FDB2016	69600 14840	FDB2086	1WD 25805 00	FDB2280	3YF W0045 00	FDB737

BRAKE PADS X-REF

COMPETITORS - OE TO FERODO

OEM Yamaha	Ferodo
4B5W004500	FDB605
4BP W0045 00	FDB781
4C6 W0045 00	FDB2284
4C8 W0045 00	FDB2217
4C9 W0045 00	FDB2238
4DA W0046 00	FDB659
4EB W0045 00	FDB2003
4ES W0045 00	FDB2015
4ES W0045 20	FDB2015
4ES W0046 50	FDB661
4EW W0045 00	FDB497
4EW W0045 01	FDB497
4EW W0046 00	FDB659
4FM W0045 00	FDB864
4FM W0045 10	FDB864
4FM W0045 20	FDB864
4FM W0046 00	FDB337
4FMW004530	FDB864
4GV F5811 00	FDB2005
4GV F5911 00	FDB2018
4GV W0045 10	FDB2018
4GY W0046 00	FDB659
4H7 W0045 10	FDB247
4HM W0045 00	FDB2003
4KG W0045 00	FDB449
4KM W0045 00	FDB781
4L0 W0045 00	FDB277
4MX W0045 00	FDB497
4NK W0045 00	FDB662
4NK W0045 01	FDB662
4NK W0046 00	FDB662
4P9 W0045 00 (from 2011)	FDB2224
4PT W0045 00	FDB737
4S5 W0045 00	FDB383
4S5 W0045 00	FDB2238
4SS W0045 00	FDB497
4SV W0045 00	FDB605
4SV W0045 50	FDB337
4SV W0045 50	FDB2084
4TW W0045 10	FDB557
4TW W0046 00	FDB2194
4VV F5811 00	FDB680
4W1 W0045 00	FDB277
4W1 W0046 09	FDB184
4W1W004510	FDB277
4WM W0045 00	FDB781
4WM W0046 00	FDB449
4X VW0046 10	FDB2084
4XV W0046 00	FDB337
4XVW004500	FDB605
51L W0045 02	FDB386
51L W0046 02	FDB386
52S F5811 00	FDB2264
59C 25806 00	FDB2126
5BK F5811 00	FDB697
5BN W0045 00	FDB781

OEM Yamaha	Ferodo
5BR F5811 00	FDB2062
5CG W0046 02	FDB2083
5D7 F5811 00	FDB892
5D7 F5811 00	FDB2018
5D7 F582W 00	FDB2184
5DH W0045 00	FDB892
5DH W0045 10	FDB892
5DH W0046 00	FDB539
5EB W0046 00	FDB2083
5EK W0045 00	FDB2083
5ET W0046 00	FDB539
5FL W0045 00	FDB605
5FL W0046 50	FDB2084
5GJ 25806 00	FDB2126
5GJ W0046 00	FDB2126
5GM W0046 00	FDB2200
5GR W0046 00	FDB539
5JJ W004 500	FDB605
5JU W0045 00	FDB636
5JW W0046 00	FDB2156
5KE W0045 00	FDB2158
5KM W0046 00	FDB2193
5LB W0045 00	FDB2083
5LV W0046 50	FDB2150
5ME F5811 00	FDB680
5MF F5811 00	FDB680
5MV W0045 00	FDB892
5MV W0045 01	FDB892
5MV W0046 00	FDB539
5NR F5811 00	FDB2074
5NR F5811 10	FDB2200
5NW W0045 00 (until 2010)	FDB2224
5PA W0045 00	FDB2015
5PA W0046 50	FDB661
5PS W0046 00	FDB2156
5PW W0045 00	FDB605
5PW W0046 50	FDB2083
5RU 25806 00	FDB2200
5RU W0045 10	FDB2003
5RU W0046 00	FDB2200
5RW F5811 00	FDB680
5S7 W0045 00	FDB781
5S9 W004S 00	FDB2264
5SL W0045 00	FDB605
5SL W0046 00	FDB754
5UN W0046 00	FDB2162
5UN W0046 50	FDB2162
5UN W0046 51	FDB2162
5UN W0046 60	FDB2162
5VK W004 600	FDB2005
5VK W0045 00	FDB2018
5VNW004500	FDB605
5VU 25805 00	FDB2003
5VU W0045 00	FDB2003
5VU W0046 00	FDB2200
5VU W0046 01	FDB2200

OEM Yamaha	Ferodo
5VX W0045 00	FDB2003
5VX W0046 00	FDB754
5WW F5811 20	FDB680
5WW F5811 20	FDB889
5XC W0045 00	FDB2219
5YU W0046 00	FDB570
B2W-25805-00	FDB2323
B97 F5806 0000	FDB659





**SHOES XREF
COMPETITORS TO FERODO**



BRAKE SHOES X-REF

COMPETITORS - OE TO FERODO

AGPA	Ferodo	AGPA	Ferodo	COBREQ	Ferodo	EBC	Ferodo
M027	FSB909	M368	FSB767	0304-CP	FSB704	504	FSB732
M034	FSB838	M371	FSB709	0307-CP	FSB733	506	FSB733
M037	FSB897	M377	FSB740	0308-CP	FSB731	507	FSB913
M045	FSB906	M378	FSB931	0309-CP	FSB708	508	FSB763
M054	FSB874	M379	FSB751	0312-CP	FSB958	510	FSB734
M079	FSB892	M391	FSB780	0313-CP	FSB740	511	FSB767
M080	FSB893	M392	FSB708	0318-CP	FSB844	512	FSB769
M081	FSB894	M393	FSB730	0320-CP	FSB705	513	FSB770
M084	FSB896	M394	FSB706			514	FSB735
M086	FSB914	M395	FSB725	EBC	Ferodo	515	FSB765
M104	FSB886	M396	FSB723	301	FSB702	516	FSB736
M113	FSB818	M397	FSB736	302	FSB703	517	FSB737
M127	FSB938	M398	FSB736	303	FSB704	518	FSB738
M150	FSB879	M400	FSB765	304	FSB705	519	FSB739
M153	FSB907	M402	FSB769	306	FSB760	520	FSB928
M183	FSB828	M403	FSB929	307	FSB966	521	FSB772
M195	FSB712	M404	FSB757	309	FSB749	522	FSB766
M203	FSB857	M410	FSB943	310	FSB706	524	FSB933
M210	FSB876	M411	FSB700	311	FSB942	527	FSB947
M228	FSB843	M412	FSB925	312	FSB707	528	FSB948
M237	FSB820	M414	FSB711	313	FSB708	533	FSB967
M254	FSB954	M417	FSB805	314	FSB943	602	FSB721
M255	FSB951	M418	FSB701	315	FSB742	603	FSB722
M256	FSB902	M425	FSB726	316	FSB741	604	FSB723
M257	FSB912	M426	FSB727	318	FSB709	605	FSB724
M258	FSB889	M430	FSB784	319	FSB750	606	FSB725
M260	FSB875	M432	FSB761	320	FSB710	609	FSB773
M261	FSB873	M438	FSB718	321	FSB711	611	FSB780
M263	FSB874	M442	FSB800	322	FSB712	613	FSB726
M264	FSB952	M446	FSB754	323	FSB740	614	FSB727
M267	FSB807	M447	FSB758	324	FSB747	616	FSB786
M270	FSB891	M451	FSB755	325	FSB743	617	FSB728
M275	FSB902	M452	FSB748	327	FSB744	618	FSB776
M278	FSB826	M453	FSB756	328	FSB745	619	FSB775
M282	FSB890	M456	FSB734	330	FSB958	620	FSB785
M285	FSB827	M457	FSB806	331	FSB746	621	FSB779
M286	FSB910	M460	FSB739	332	FSB751	622	FSB778
M289	FSB702	M464	FSB766	333	FSB714	624	FSB777
M290	FSB703	M465	FSB824	334	FSB754	626	FSB784
M291	FSB715	M466	FSB851	335	FSB758	627	FSB729
M294	FSB867	M484	FSB861	336	FSB715	630	FSB790
M297	FSB705	M489	FSB762	338	FSB756	632	FSB792
M298	FSB714	M494	FSB863	339	FSB925	633	FSB929
M301	FSB704	M497	FSB792	340	FSB755	634	FSB782
M303	FSB777	M500	FSB883	341	FSB748	635	FSB957
M304	FSB716	M503	FSB733	343	FSB761	702	FSB716
M306	FSB738	M504	FSB948	344	FSB757	703	FSB717
M307	FSB733	M506	FSB895	345	FSB945	704	FSB797
M308	FSB940	M515	FSB958	346	FSB753	705	FSB799
M318	FSB932	M520	FSB915	347	FSB931	706	FSB718
M346	FSB722	M521	FSB772	350	FSB762	708	FSB793
M347	FSB721	M522	FSB946	351	FSB946	709	FSB719
M351	FSB877	M523	FSB959	352	FSB963	710	FSB794
M363	FSB737	M525	FSB948	501	FSB730	711	FSB800
M364	FSB763			502	FSB764	713	FSB795
M365	FSB778	COBREQ	Ferodo	503	FSB731	715	FSB802
		0302-CP	FSB762				

BRAKE SHOES X-REF

COMPETITORS - OE TO FERODO

EBC	Ferodo	EBC	Ferodo	FRAS-LE	Ferodo	GALFER	Ferodo
717	FSB932	901	FSB869	LH/806	FSB762	MF458	FSB731
801	FSB850	902	FSB879	LH/807	FSB704	MF459	FSB765
802	FSB812	903	FSB874	LH/808	FSB708	MF460	FSB739
803	FSB813	904	FSB891	LH/809	FSB958	MF461	FSB732
804	FSB936	905	FSB890	LH/810	FSB740	MF471	FSB767
805	FSB939	906	FSB885	LH/812	FSB705	MF475	FSB772
806	FSB940	907	FSB889	LY/822	FSB733	MF477	FSB769
807	FSB941	908	FSB902	LY/823	FSB731	MF601	FSB874
808	FSB952	909	FSB910			MF602	FSB890
809	FSB951	910	FSB875	GALFER	Ferodo	MF603	FSB912
811	FSB817	911	FSB873	MF001	FSB714	MF604	FSB893
812	FSB814	912	FSB886	MF002	FSB704	MF605	FSB892
813	FSB815	917/918	FSB878	MF003	FSB705	MF606	FSB754
816	FSB954	921	FSB876	MF004	FSB712	MF608	FSB820
817	FSB956	922	FSB897	MF005	FSB709	MF609	FSB703
818	FSB958	924	FSB912	MF006	FSB706	MF610	FSB701
819	FSB959	926	FSB907	MF008	FSB715	MF611	FSB805
820	FSB960	927	FSB852	MF009	FSB748	MF612	FSB700
821	FSB847	929	FSB818	MF010	FSB702	MF613	FSB806
822	FSB819	931	FSB908	MF016	FSB742	MF615	FSB804
824	FSB964	933	FSB820	MF019	FSB708	MF616	FSB863
831	FSB807	934	FSB825	MF022	FSB760	MF617	FSB910
833	FSB857	935	FSB826	MF029	FSB710	MF618	FSB902
841	FSB898	936	FSB827	MF035	FSB711	MF619	FSB891
842	FSB849	940	FSB904	MF037	FSB958	MF620	FSB894
843	FSB901	941	FSB768	MF043	FSB761	MF621	FSB895
845	FSB844	942	FSB887	MF044	FSB925	MF623	FSB809
851	FSB922	943	FSB846	MF049	FSB931	MF625	FSB867
852	FSB920	945	FSB877	MF050	FSB945	MF631	FSB915
853	FSB919	948	FSB853	MF051	FSB963	MF633	FSB889
854	FSB921	949	FSB854	MF151	FSB721	MF636	FSB938
858	FSB916	950	FSB955	MF152	FSB718	MF637	FSB896
859	FSB863	951	FSB855	MF153	FSB719	MF639	FSB939
860	FSB700	952	FSB911	MF160	FSB794	MF640	FSB947
861	FSB701	954	FSB838	MF161	FSB799	MF641	FSB883
862	FSB804	955	FSB834	MF165	FSB932	MF684	FSB876
863	FSB805	958	FSB839	MF301	FSB777	MF712	FSB898
864	FSB806	959	FSB843	MF303	FSB725	MF717	FSB940
865	FSB851	965	FSB837	MF304	FSB784	MF723	FSB956
867	FSB871	975	FSB835	MF305	FSB790	MF740	FSB958
868	FSB888	976	FSB836	MF308	FSB957	MF760	FSB906
877	FSB870	977	FSB841	MF317	FSB722		
880	FSB867	978	FSB823	MF321	FSB782	LUCAS/TRW	Ferodo
881	FSB892	979	FSB824	MF323	FSB724	MCS800	FSB704
882	FSB893	981	FSB909	MF326	FSB726	MCS801	FSB942
885	FSB894	982	FSB845	MF326	FSB727	MCS802	FSB742
886	FSB895	983	FSB781	MF329	FSB776	MCS803	FSB707
887	FSB862	986	FSB809	MF333	FSB729	MCS804	FSB705
890	FSB896	987	FSB759	MF334	FSB779	MCS805	FSB709
892	FSB914	989	FSB842	MF342	FSB929	MCS806	FSB711
894	FSB860	990	FSB828	MF451	FSB733	MCS807	FSB708
895	FSB861	992	FSB856	MF452	FSB766	MCS808	FSB710
896	FSB915	993/994	FSB872	MF453	FSB738	MCS809	FSB741
897	FSB883	996	FSB906	MF454	FSB730	MCS810	FSB743
899	FSB938			MF456	FSB734	MCS811	FSB749
900	FSB937	FRAS-LE	Ferodo	MF457	FSB736	MCS812	FSB740
		LA/801	FSB844				

BRAKE SHOES X-REF

COMPETITORS - OE TO FERODO

LUCAS/TRW	Ferodo	LUCAS/TRW	Ferodo	NEWFREN	Ferodo	NEWFREN	Ferodo
MCS813	FSB703	MCS950	FSB769	GF0183	FSB818	GF1091	FSB920
MCS814	FSB746	MCS951	FSB732	GF0190	FSB889	GF1092	FSB921
MCS815	FSB751	MCS952	FSB767	GF0197/8	FSB878	GF1093	FSB702
MCS816	FSB744	MCS953	FSB733	GF0200	FSB898	GF1104	FSB922
MCS817	FSB706	MCS954	FSB770	GF0200/A	FSB911	GF1105	FSB733
MCS818	FSB956	MCS955	FSB734	GF0201	FSB876	GF1109	FSB710
MCS819	FSB958	MCS956	FSB738	GF0204	FSB901	GF1110	FSB850
MCS820	FSB715	MCS957	FSB765	GF0208	FSB852	GF1111	FSB923
MCS821	FSB755	MCS958	FSB736	GF0210	FSB908	GF1112	FSB924
MCS822	FSB761	MCS959	FSB784	GF0212	FSB853	GF1120	FSB782
MCS823	FSB957	MCS960	FSB730	GF0213	FSB849	GF1121	FSB773
MCS824	FSB757	MCS961	FSB764	GF0214	FSB838	GF1124	FSB814
MCS825	FSB714	MCS962	FSB731	GF0215	FSB912	GF1126	FSB815
MCS826	FSB958	MCS963	FSB739	GF0218	FSB837	GF1130	FSB741
MCS827	FSB702	MCS964	FSB737	GF0219	FSB844	GF1131	FSB854
MCS828	FSB712	MCS965	FSB763	GF0222	FSB904	GF1132	FSB955
MCS829	FSB747	MCS966	FSB913	GF0223	FSB768	GF1133	FSB855
MCS830	FSB745	MCS968	FSB947	GF0224	FSB887	GF1135	FSB857
MCS831	FSB762	MCS969	FSB772	GF0225	FSB846	GF1137	FSB807
MCS832	FSB756	MCS980	FSB874	GF0227	FSB759	GF1140	FSB793
MCS833	FSB767	MCS981	FSB890	GF0229	FSB781	GF1141	FSB794
MCS834	FSB769	MCS982	FSB893	GF0232	FSB841	GF1142	FSB795
MCS835	FSB963	MCS983	FSB892	GF0233	FSB909	GF1143	FSB712
MCS850	FSB741	MCS984	FSB938	GF0234	FSB888	GF1145	FSB823
MCS851	FSB795	MCS985	FSB915	GF0235	FSB845	GF1146	FSB722
MCS852	FSB719	MCS986	FSB891	GF0236	FSB856	GF1147	FSB721
MCS853	FSB718	MCS987	FSB894	GF0242/3	FSB872	GF1147/A	FSB721
MCS854	FSB722	MCS988	FSB902	GF0245	FSB906	GF1148	FSB797
MCS855	FSB721	MCS989	FSB940	GF0246	FSB870	GF1150	FSB742
MCS856	FSB728	MCS990	FSB883	GF0249	FSB892	GF1151	FSB877
MCS857	FSB802	MCS991	FSB792	GF0250	FSB893	GF1152	FSB812
MCS858	FSB800	MCS994	FSB954	GF0251	FSB894	GF1153	FSB825
MCS860	FSB716	MCS995	FSB946	GF0252	FSB895	GF1154	FSB820
MCS861	FSB717			GF0253	FSB862	GF1155	FSB826
MCS890	FSB823	NEWFREN	Ferodo	GF0254	FSB896	GF1156	FSB827
MCS891	FSB824	GF0024	FSB869	GF0256	FSB914	GF1157	FSB787
MCS892	FSB710	GF0084	FSB847	GF0257	FSB915	GF1158	FSB776
MCS901	FSB723	GF0087	FSB875	GF0258	FSB982	GF1159	FSB817
MCS902	FSB724	GF0089	FSB839	GF0259	FSB983	GF1160	FSB813
MCS904	FSB773	GF0097	FSB897	GF0260	FSB937	GF1161	FSB786
MCS905	FSB782	GF0097/A	FSB905	GF0261	FSB938	GF1162	FSB913
MCS906	FSB780	GF0127	FSB873	GF0262	FSB939	GF1163	FSB737
MCS907	FSB725	GF0128	FSB874	GF0263	FSB940	GF1164	FSB763
MCS915	FSB786	GF0130	FSB885	GF0264	FSB941	GF1165	FSB778
MCS916	FSB776	GF0150	FSB842	GF0265	FSB951	GF1166	FSB779
MCS917	FSB778	GF0151	FSB902	GF0266	FSB952	GF1167	FSB734
MCS918	FSB729	GF0152	FSB910	GF0268	FSB954	GF1168	FSB767
MCS919	FSB725	GF0153	FSB907	GF0269	FSB4016	GF1169	FSB743
MCS920	FSB936	GF0159	FSB891	GF1043	FSB704	GF1170	FSB749
MCS921	FSB777	GF0160	FSB879	GF1044	FSB819	GF1171	FSB709
MCS940	FSB700	GF0162	FSB890	GF1075	FSB916	GF1172	FSB744
MCS941	FSB701	GF0170	FSB843	GF1076	FSB917	GF1173	FSB745
MCS942	FSB804	GF0174	FSB886	GF1081	FSB918	GF1174	FSB746
MCS943	FSB805	GF0176	FSB880	GF1084	FSB835	GF1175	FSB707
MCS944	FSB806	GF0177	FSB881	GF1088	FSB836	GF1177	FSB740
MCS945	FSB863	GF0179	FSB796	GF1090	FSB919	GF1178	FSB705

BRAKE SHOES X-REF

COMPETITORS - OE TO FERODO

NEWFREN	Ferodo	NEWFREN	Ferodo	SBS	Ferodo	SBS	Ferodo
GF1179	FSB751	GF1255	FSB775	SBS2028	FSB731	SBS2107	FSB779
GF1182	FSB834	GF1256	FSB805	SBS2029	FSB740	SBS2108	FSB778
GF1183	FSB828	GF1257	FSB806	SBS2030	FSB751	SBS2111	FSB725
GF1184	FSB958	GF1259	FSB753	SBS2031	FSB747	SBS2112	FSB730
GF1186	FSB724	GF1260	FSB824	SBS2032	FSB732	SBS2113	FSB770
GF1187	FSB738	GF1261	FSB809	SBS2033	FSB913	SBS2114	FSB928
GF1188	FSB732	GF1262	FSB871	SBS2034	FSB733	SBS2115	FSB772
GF1190	FSB735	GF1263	FSB945	SBS2035	FSB767	SBS2116	FSB850
GF1191	FSB780	GF1264	FSB766	SBS2036	FSB763	SBS2117	FSB812
GF1192	FSB708	GF1266	FSB851	SBS2037	FSB734	SBS2118	FSB813
GF1193	FSB730	GF1269	FSB790	SBS2038	FSB718	SBS2120	FSB814
GF1194	FSB706	GF1270	FSB772	SBS2039	FSB797	SBS2121	FSB815
GF1195	FSB725	GF1273	FSB928	SBS2040	FSB799	SBS2139	FSB700
GF1196	FSB723	GF1274	FSB932	SBS2041	FSB958	SBS2140	FSB701
GF1197	FSB736	GF1276	FSB931	SBS2042	FSB746	SBS2141	FSB804
GF1198	FSB703	GF1277	FSB867	SBS2043	FSB756	SBS2142	FSB805
GF1199	FSB764	GF1279	FSB936	SBS2044	FSB925	SBS2143	FSB863
GF1200	FSB731	GF1283	FSB860	SBS2046	FSB761	SBS2146	FSB874
GF1202	FSB769	GF1284	FSB861	SBS2047	FSB757	SBS2171	FSB823
GF1203	FSB770	GF1289	FSB762	SBS2048	FSB753	SBS2172	FSB824
GF1204	FSB765	GF1291	FSB933	SBS2049	FSB737	SBS2178	FSB933
GF1206	FSB760	GF1294	FSB863	SBS2050	FSB738	SBS2181	FSB777
GF1207	FSB966	GF1297	FSB792	SBS2052	FSB784	SBS2182	FSB764
GF1209	FSB942	GF1300	FSB883	SBS2054	FSB932	SBS2183	FSB721
GF1210	FSB943	GF1302	FSB929	SBS2055	FSB755	SBS2184	FSB893
GF1211	FSB700	GF1303	FSB947	SBS2056	FSB717	SBS2185	FSB892
GF1212	FSB925	GF1304	FSB948	SBS2057	FSB714	SBS2186	FSB894
GF1213	FSB750	GF1305	FSB946	SBS2058	FSB708	SBS2187	FSB895
GF1214	FSB711	GF1307	FSB946	SBS2059	FSB711	SBS2188	FSB883
GF1215	FSB747	GF1308	FSB956	SBS2060	FSB719	SBS2189	FSB762
GF1216	FSB728	GF1309	FSB957	SBS2063	FSB769	SBS2192	FSB766
GF1217	FSB739	GF1310	FSB958	SBS2064	FSB735	SBS2193	FSB758
GF1218	FSB701	GF1311	FSB959	SBS2065	FSB765	SBS2194	FSB754
GF1219	FSB804	GF1312	FSB960	SBS2066	FSB736	SBS2195	FSB938
GF1225	FSB726	GF1316	FSB963	SBS2068	FSB749	SBS2196	FSB910
GF1226	FSB727	GF1317	FSB964	SBS2069	FSB706	SBS2197	FSB794
GF1228	FSB729	GF1318	FSB967	SBS2070	FSB743	SBS2198	FSB946
GF1229	FSB715			SBS2071	FSB943	SBS2199	FSB947
GF1230	FSB784	SBS	Ferodo	SBS2072	FSB741	SBS2200	FSB940
GF1231	FSB785	SBS2010	FSB702	SBS2074	FSB712	SBS2201	FSB956
GF1232	FSB761	SBS2011	FSB703	SBS2075	FSB743	SBS2202	FSB957
GF1233	FSB777	SBS2012	FSB704	SBS2077	FSB751	SBS2203	FSB958
GF1235	FSB716	SBS2013	FSB705	SBS2080	FSB715	SBS2205	FSB954
GF1236	FSB717	SBS2014	FSB721	SBS2082	FSB748	SBS2206	FSB867
GF1237	FSB799	SBS2015	FSB722	SBS2083	FSB945	SBS2207	FSB946
GF1238	FSB718	SBS2016	FSB724	SBS2085	FSB931		
GF1240	FSB719	SBS2017	FSB723	SBS2088	FSB793	VESRAH	Ferodo
GF1242	FSB800	SBS2018	FSB725	SBS2091	FSB795	VB-101	FSB704
GF1245	FSB802	SBS2019	FSB760	SBS2093	FSB802	VB-119	FSB943
GF1246	FSB754	SBS2020	FSB726	SBS2097	FSB773	VB-123	FSB966
GF1247	FSB758	SBS2021	FSB739	SBS2098	FSB782	VB-124	FSB942
GF1248	FSB714	SBS2023	FSB707	SBS2099	FSB780	VB-125	FSB707
GF1251	FSB755	SBS2024	FSB742	SBS2101	FSB727	VB-126	FSB705
GF1252	FSB748	SBS2025	FSB717	SBS2102	FSB786	VB-127	FSB742
GF1253	FSB756	SBS2026	FSB709	SBS2103	FSB728	VB-128	FSB741
GF1254	FSB757	SBS2027	FSB710	SBS2104	FSB776	VB-129	FSB710

BRAKE SHOES X-REF

COMPETITORS - OE TO FERODO

VESRAH	Ferodo	VESRAH	Ferodo	OEM Honda	Ferodo	OEM Kawasaki	Ferodo
VB-130	FSB706	VB-316	FSB786	06430 GE8 405	FSB703	41048 1070	FSB719
VB-132	FSB708	VB-318	FSB785	06430 GET 000	FSB714	41048 1076	FSB721
VB-133	FSB711	VB-319	FSB764	06430 GFZ 000	FSB963	41048 1082	FSB794
VB-134	FSB702	VB-321	FSB784	06430 GJ3 932	FSB715	41048 1083	FSB802
VB-135	FSB760	VB-323	FSB727	06430 GW3 980	FSB704	41048 1084	FSB717
VB-136	FSB709	VB-325	FSB792	06430 GZ9 003	FSB702	41048 1090	FSB800
VB-137	FSB747	VB-328	FSB777	06430 KBG 700	FSB706	41048 1093	FSB795
VB-138	FSB743	VB-330	FSB883	06430 KBG 701	FSB706	41048 1097	FSB716
VB-139	FSB749	VB-404	FSB793	06430 KFG 000	FSB946	41048 1107	FSB724
VB-140	FSB740	VB-405	FSB795	06430 KRP 980	FSB963	41048 1122	FSB793
VB-141	FSB703	VB-406	FSB722	06430 MCL 700	FSB761	41048 1141	FSB722
VB-142	FSB958	VB-407	FSB724	06430 MM8 881	FSB761	41048 1142	FSB718
VB-143	FSB746	VB-408	FSB797	06430 MR5 006	FSB761	42019 011	FSB724
VB-144	FSB745	VB-409	FSB721	06430 MW3 671	FSB711	42019 013	FSB716
VB-146	FSB761	VB-410	FSB721	06430 MZ5 003	FSB761		
VB-147	FSB925	VB-411	FSB799	06430-131-405	FSB702	OEM KTM	Ferodo
VB-148	FSB751	VB-412	FSB719	06430-HB2-405	FSB714	55009035000	FSB814
VB-149	FSB744	VB-413	FSB718	06430-KBR-003	FSB740		
VB-150	FSB714	VB-416	FSB717	06450 GAG 003	FSB704	OEM Kymco	Ferodo
VB-151	FSB748	VB-417	FSB802	06450 KC2 680	FSB707	43120 KUDU 900	FSB704
VB-152	FSB945	VB-419	FSB794	06450 KS4 601	FSB958	4312A E22 000	FSB704
VB-154	FSB746			06450 MC4 415	FSB744	4312A KUDU 920	FSB958
VB-157	FSB946	OEM Aprilia	Ferodo	06450 MC4 415	FSB751	45120 KCP9 000	FSB704
VB-158	FSB755	56292R	FSB938	06450-178-932	FSB704	4512A LCB4 910	FSB704
VB-159	FSB958	8213133	FSB704	06455 GAG 003	FSB715		
VB-160S	FSB963	8213424	FSB956	43120 393 305	FSB710	OEM MALAGUTI	Ferodo
VB-206	FSB770			43120 428 013	FSB740	11940300	FSB704
VB-208	FSB734	OEM Benelli	Ferodo	43120 430 305	FSB743	11971000	FSB704
VB-210	FSB734	R44790031A0	FSB704	43120 458 305	FSB741		
VB-212	FSB732			43120 GC4 832	FSB714	OEM Malagutti	Ferodo
VB-219	FSB913	OEM BETAMOTOR	Ferodo	43120 KM1305	FSB748	11907700	FSB907
VB-220	FSB767	1242150000	FSB704	43120 KS6 305	FSB958		
VB-223	FSB733			43120 MG7 003	FSB755	OEM Piaggio	Ferodo
VB-224	FSB730	OEM BMW	Ferodo	43120 MG7 405	FSB755	2691825	FSB894
VB-225	FSB735	34 11 2 311 079	FSB806	43120 ML4 711	FSB708	2721845	FSB938
VB-226	FSB764	34 21 2 310 523	FSB701	43120 MM9 780	FSB709	2727115	FSB940
VB-227	FSB769	34 21 2 311 080	FSB700	43120 MM9 781	FSB709	2736235	FSB938
VB-228	FSB734	34 21 2 311 082	FSB804	43120 MR1 611	FSB711	414429	FSB893
VB-229	FSB731			43120 MR5 006	FSB761	414497	FSB910
VB-230	FSB765	OEM Bultaco	Ferodo	43120 MW3 671	FSB711	56292R	FSB938
VB-231	FSB736	48 06 056	FSB857	43120-428-405	FSB740	FK203900	FSB4016
VB-233	FSB737			43120-GW6-306	FSB714	I272714	FSB895
VB-234	FSB763	OEM Derbi	Ferodo	43120-GZ9-003	FSB712		
VB-235	FSB733	00G01300931	FSB777	43130 GE9 003	FSB754	OEM Suzuki	Ferodo
VB-239	FSB947			45120 286 000	FSB943	54041 30F00	FSB777
VB-302	FSB721	OEM Gilera	Ferodo	45120 369 305	FSB742	54400 02820	FSB727
VB-305	FSB773	267126	FSB902	45120 369 670	FSB943	54400 03810	FSB777
VB-307	FSB780	4145574	FSB889	45120 E60 000	FSB704	54400 03820	FSB777
VB-308	FSB725			45120 GE8 505	FSB712	54400-08810	FSB723
VB-309	FSB724	OEM Honda	Ferodo	45120 KA4 305	FSB746	54401 07820	FSB721
VB-310	FSB723	06430 354 405	FSB749	45120 KB9 005	FSB705	54401-43810	FSB723
VB-311	FSB728	06430 428 003	FSB740	45120 KB9 015	FSB705	54401-43840	FSB723
VB-312	FSB722	06430 GBJ 740	FSB709	45351 GBM 750	FSB704	54402 07810	FSB721
VB-313	FSB726	06430 GBJ K20	FSB963			54402 35820	FSB722
VB-314	FSB727	06430 GC4 831	FSB714	OEM Husqvarna	Ferodo	54410 14100	FSB776
VB-315	FSB779	06430 GCW 000	FSB714	1516-54301	FSB850	54410 14300	FSB778

BRAKE SHOES X-REF

COMPETITORS - OE TO FERODO

OEM Suzuki	Ferodo
54410 46B01	FSB792
64400 11870	FSB773
64400 31830	FSB782
64400 34830	FSB780
64400 38810	FSB784
64400 38820	FSB784
64400 44810	FSB725
64410 14100	FSB786
64410 38A00	FSB784
64410 40301	FSB785
64410 44B00	FSB725
64410 44B10	FSB790

OEM Sym	Ferodo
4312A E22 900	FSB704
4312A E60 000	FSB704
4312A E60 900	FSB704
4312A Y01 E00	FSB704

OEM Yamaha	Ferodo
25G 25130 00	FSB733
25G 25330 00	FSB733
25G W2536 01	FSB732
322 W2535 10	FSB913
39K 25130 00	FSB764
39K W2535 00	FSB764
3D9 W2533 00	FSB733
3DR W2536 00	FSB765
3DR W253E 00	FSB765
3EC W2535 00	FSB764
3EC W253A 00	FSB764
3FA W253A 00	FSB733
3GW W253A 00	FSB734
3LS W2536 00	FSB733
3LS W253E 00	FSB947
3LT W253E 00	FSB769
3PT W2535 00	FSB730
3PT W2535 10	FSB730
3PT W253A 10	FSB730
3TE W2535 00	FSB772
4BE W2536 00	FSB731
4BE W253E 00	FSB731
4BX W2534 00	FSB738
4DR W2536 00	FSB765
4GR W253E 00	FSB767
4HC W2536 00	FSB736
4JP W2535 00	FSB739
4KN W2536 11	FSB731
4KN W253E 11	FSB731
4TA W253E 00	FSB731
4TA W253E 01	FSB731
4V4 W253A 00	FSB763
4XE WF531 00	FSB948
5ML X2533 00	FSB967
5R3 W253E 00	FSB735



FERODO[®]

DISCS

MOTORCYCLE APPLICATIONS



FERODO[®]

MOTORCYCLE



DISCS TYPE



DISCS TYPE

ADLY

PREDATOR	50	→	FMD0097	R		
SS SUPERSONIC	50	2004 → 2005	FMD0097	R		
TB THUNDERBIKE	50	2008 → 2009	FMD0097	R		
PREDATOR	100	→	FMD0097	R		
SUPER SONIC	100	2004 → 2005	FMD0097	R		
SUPER SONIC ALL MODELS	125	2001 → 2005	FMD0097	R		
THUNDER BIKE	125	→	FMD0097	R		
THUNDER BIKE DT	125	→	FMD0097	R		

APRILIA

AMICO all models	50	1992 →	FMD0001	R		
AREA 51	50	1998 →	FMD0002	R	FMD0002	R
AREA 51 SBK	50	2000 → 2002			FMD0002	R
GULLIVER	50	1995 → 1998	FMD0002	R		
HABANA	50	1998 →	FMD0002	R		
MOJTO	50	1999 → 2004	FMD0002	R		
RALLY	50	1995 →	FMD0002	R		
RALLY liquid cooled	50	1996 →	FMD0002	R	FMD0002	R
RS	50	1999 → 2005			FMD0170	R
RS REPLICIA	50	2000 → 2005	FMD0051	R	FMD0170	R
SCARABEO DE-LUX	50	1998 → 2002			FMD0002	R
SCARABEO	50	1998 → 2005	FMD0002	R		
SCARABEO 4T	50	2002 → 2009			FMD0002	R
SCARABEO DITECH	50	2001 → 2004			FMD0002	R
SCARABEO 4T 4V	50	2010 → 2017	FMD0003	R		
SCARABEO 2T	50	2010 → 2019	FMD0003	R		
SONIC SPICE	50	1997 →	FMD0001	R		
SONIC GP	50	1997 →	FMD0001	R		
SR all models	50	1993 → 1995	FMD0002	R		
SR WWW	50	1997 → 2001	FMD0002	R		
SR RACING	50	1997 → 2004	FMD0002	R	FMD0002	R
SR H20 DITECH EURO 2	50	2002 → 2003	FMD0002	R	FMD0002	R
SR STREET	50	2003 → 2015	FMD0002	R	FMD0002	R
SR R FACTORY (motore Piaggio)	50	2004 → 2015	FMD0002	R	FMD0002	R
SR R / SR REPLICIA SBK	50	2004 → 2017	FMD0002	R	FMD0002	R
SR MOTARD 2T	50	2012 → 2018	FMD0007	R		
SR R	50	2018 → 2019	FMD0002	R	FMD0002	R
SR STEALTH	50	1997 → 1999	FMD0002	R	FMD0002	R
SR H20 DITECH E (carburatore)	50	2000 → 2002	FMD0002	R	FMD0002	R
TUONO	50	2003 → 2004	FMD0051	R	FMD0170	R
TUONO	50	2005 →	FMD0051	R	FMD0170	R
SCARABEO	100	1999 → 2006	FMD0003	R		
SCARABEO 4T	100	2010 → 2016	FMD0003	R		
ATLANTIC	125	2003 → 2011	FMD0326	R	FMD0327	R
AF1 FUTURA	125	1990 → 1992	FMD0111	RX		
HABANA	125	1998 →	FMD0002	R		
LEONARDO	125	1995 → 2004	FMD0003	R	FMD0002	R
MOJTO all models	125	1999 → 2004	FMD0002	R		
MX	125	2004 → 2007	FMD0111	RX	FMD0164	R
PEGASO	125	1990 → 1991			FMD0164	R
RS REPLICIA	125	1992 → 1997	FMD0111	RX	FMD0164	R
RS EXTREMA	125	1992 → 1997	FMD0111	RX	FMD0164	R
RS	125	1995 → 1995	FMD0111	RX		
RS	125	1996 → 2011	FMD0111	RX	FMD0170	R
SCARABEO (motore Rotax)	125	1999 → 2003	FMD0050	R	FMD0003	R
SCARABEO GT	125	1999 → 2003	FMD0050	R	FMD0003	R
SCARABEO (motore Piaggio)	125	2003 → 2004	FMD0050	R		
SCARABEO	125	2004 → 2006	FMD0050	R		
SCARABEO EU3	125	2006 → 2007	FMD0050	R		
SCARABEO LIGHT	125	2007 → 2008	FMD0050	R	FMD0170	R
SCARABEO i.e. LIGHT	125	2008 → 2009	FMD0050	R	FMD0170	R
SCARABEO i.e.	125	2010 → 2015	FMD0003	R		
SPORT CITY	125	2004 → 2005	FMD0050	R	FMD0003	R
SPORT CITY EU3	125	2006 → 2008	FMD0050	R	FMD0003	R
SPORT CITY CUBE	125	2008 → 2010	FMD0050	R	FMD0003	R
SR MOTARD	125	2012 → 2016	FMD0007	R		
SR	125	1999 →	FMD0002	R		
TUONO	125	2003 → 2004	FMD0111	RX	FMD0170	R
TUONO	125	2005 → 2007	FMD0111	RX		
LEONARDO	150	1997 → 1998	FMD0003	R	FMD0002	R
LEONARDO	150	1999 → 2004	FMD0003	R	FMD0002	R
SCARABEO	150	1998 → 2003	FMD0050	R	FMD0003	R
MOJTO all models	150	1999 → 2004	FMD0002	R		
SCARABEO GT	150	2004 →	FMD0050	R	FMD0003	R
SR	150	1999 →	FMD0002	R		

ADLY

10000

FERODO

RACING

Updated on November 2020



DISCS TYPE



DISCS TYPE

...APRILIA

ARECIFE (spagna)	200	2003 →	FMD0326	R	FMD0327	R
ATLANTIC	200	2003 → 2005	FMD0326	R	FMD0327	R
SCARABEO	200	2001 → 2003	FMD0050	R	FMD0003	R
SCARABEO GT	200	2002 → 2004	FMD0050	R	FMD0003	R
SCARABEO (motore Piaggio)	200	2003 → 2006	FMD0050	R		
SCARABEO	200	2007 → 2010	FMD0050	R	FMD0170	R
SCARABEO i.e.	200	2010 → 2015	FMD0003	R		
SPORT CITY	200	2004 → 2005	FMD0050	R	FMD0003	R
SPORT CITY EU3	200	2006 → 2008	FMD0050	R	FMD0003	R
SPORT CITY CUBE	200	2009 →	FMD0050	R	FMD0003	R
ATLANTIC	250	2003 → 2006	FMD0326	R	FMD0327	R
LEONARDO	250	1999 → 2001	FMD0003	R	FMD0171	R
LEONARDO ST	250	2001 → 2004	FMD0003	R	FMD0171	R
RS	250	1995 → 2003			FMD0005	R
RS REPLICA	250	1998 → 2003	FMD0132 (x2)	RX		
SCARABEO	250	2004 → 2006	FMD0050	R		
SCARABEO LIGHT	250	2006 → 2008	FMD0050 (x2)	R	FMD0170	R
SCARABEO i.e.	250	2006 → 2009	FMD0050 (x2)	R		
SPORT CITY EU3	250	2006 →	FMD0050 (x2)	R	FMD0003	R
SPORT CITY CUBE	250	2008 → 2010	FMD0050 (x2)	R	FMD0003	R
ATLANTIC	300	2010 → 2011	FMD0326	R	FMD0327	R
LEONARDO	300	2002 → 2004	FMD0003	R	FMD0171	R
SCARABEO LIGHT	300	2006 → 2010	FMD0050	R		
SCARABEO SPECIAL i.e.	300	2009 → 2012	FMD0050	R	FMD0053	R
SCARABEO S i.e.	300	2009 → 2012	FMD0003	R		
SPORT CITY CUBE	300	2008 →	FMD0050 (x2)	R		
SR MAX i	300	2010 → 2016	FMD0055	R	FMD0053	R
ATLANTIC SPRINT	400	2005 → 2008	FMD0050	R	FMD0171	R
SCARABEO URBAN	400	2006 → 2008	FMD0050 (x2)	R	FMD0053	R
SCARABEO LIGHT	400	2006 → 2008	FMD0050 (x2)	R	FMD0053	R
RXV 4.5	450	2005 →			FMD0406	R
SXV	450	2005 → 2007	FMD0401	RX	FMD0406	R
SXV	450	2008 →			FMD0406	R
ARECIFE (spagna)	500	2002 → 2004	FMD0050 (x2)	R		
ATLANTIC SPRINT	500	2005 → 2008	FMD0050	R	FMD0171	R
ATLANTIC	500	2002 → 2004	FMD0050 (x2)	R	FMD0171	R
SCARABEO URBAN	500	2006 → 2012	FMD0050 (x2)	R	FMD0053	R
SCARABEO LIGHT	500	2006 → 2008	FMD0050 (x2)	R		
SCARABEO	500	2002 → 2006	FMD0050 (x2)	R	FMD0171	R
SCARABEO i.e.	500	2010 → 2012	FMD0003 (x2)	R		
RXV 5.5	550	2005 →			FMD0406	R
SXV	550	2005 → 2007	FMD0401	RX	FMD0406	R
SXV	550	2008 →			FMD0406	R
PEGASO	600	1989 → 1990			FMD0164	R
MOTO 6.5	650	1995 → 2002			FMD0164	R
PEGASO	650	1991 → 2000	FMD0038	RF	FMD0164	R
PEGASO I.E.	650	2001 → 2004	FMD0038	RF	FMD0207	R
PEGASO STRADA	650	2005 → 2009	FMD0111	RX		
PEGASO TRAIL	650	2005 → 2008	FMD0038	RF	FMD0207	R
PEGASO FACTORY	650	2007 → 2009	FMD0111	RX	FMD0207	R
DORSODURO	750	2008 → 2017	FMD0111 (x2)	RX		
DORSODURO FACTORY	750	2010 → 2013	FMD0111 (x2)	RX		
SL SHIVER	750	2007 → 2017	FMD0111 (x2)	RX		
SHIVER GT	750	2009 →	FMD0111 (x2)	RX		
MANA	850	2007 → 2011	FMD0111 (x2)	RX		
MANA GT	850	2009 → 2016	FMD0111 (x2)	RX		
DORSODURO ABS	900	2017 →	FMD0111 (x2)	RX		
SHIVER ABS	900	2017 →	FMD0111 (x2)	RX		
RST FUTURA	1000	2001 → 2004	FMD0111 (x2)	RX		
RSV	1000	1998 → 2000	FMD0111 (x2)	RX	FMD0005	R
RSV SP	1000	1999 → 2000	FMD0111 (x2)	RX	FMD0005	R
RSV R	1000	2000 → 2001	FMD0111 (x2)	RX	FMD0005	R
RSV	1000	2001 → 2002	FMD0352 (x2)	RX	FMD0005	R
RSV R	1000	2001 → 2005	FMD0352 (x2)	RX	FMD0005	R
RSV	1000	2002 → 2003	FMD0352 (x2)	RX		
RSV TUONO	1000	2002 → 2005			FMD0005	R
RSV FACTORY	1000	2003 → 2007	FMD0352 (x2)	RX		
RSV R TUONO	1000	2003 → 2005			FMD0005	R
RSV TUONO FIGTHER	1000	2003 → 2005			FMD0005	R
RSV R FACTORY	1000	2004 → 2008			FMD0005	R
RSV R	1000	2006 → 2008	FMD0352 (x2)	RX		
RSV R TUONO FACTORY	1000	2006 → 2009			FMD0005	R
RSV4 R	1000	2009 → 2009	FMD0352 (x2)	RX		
RSV4 FACTORY	1000	2009 → 2010	FMD0352 (x2)	RX	FMD0005	R
RSV4 SBK RACING	1000	2009 → 2010			FMD0005	R
RSV4 R	1000	2010 → 2010	FMD0352 (x2)	RX	FMD0005	R

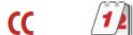
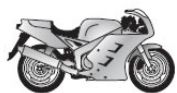

DISCS TYPE



DISCS TYPE

APRILIA

RSV4 FACTORY APRC	1000	2011 → 2012	FMD0352 (x2)	RX	FMD0005	R
RSV4 R	1000	2011 → 2011			FMD0005	R
RSV4 FACTORY APRC R - ABS	1000	2011 → 2013			FMD0005	R
RSV4 FACTORY ABS	1000	2013 →			FMD0005	R
RSV4 FACTORY APRC ABS	1000	2013 → 2014	FMD0352 (x2)	RX		
RSV4 R APRC	1000	2011 → 2012	FMD0352 (x2)	RX	FMD0005	R
RSV4 R APRC ABS	1000	2013 → 2014	FMD0352 (x2)	RX	FMD0005	R
RSV4 RR	1000	2015 → 2016	FMD0352 (x2)	RX		
SL 1000 FALCO	1000	2000 → 2004	FMD0111 (x2)	RX	FMD0005	R
TUONO FIGHTER	1000	2002 → 2005	FMD0111 (x2)	RX		
TUONO R (4 pads per caliper)	1000	2002 → 2005	FMD0352 (x2)	RX		
TUONO	1000	2002 → 2005	FMD0352 (x2)	RX		
TUONO R (2 pads per caliper)	1000	2002 → 2009	FMD0111 (x2)	RX		
TUONO V4 R	1000	2011 → 2013	FMD0111 (x2)	RX	FMD0005	R
TUONO V4 R APRC	1000	2011 → 2013	FMD0111 (x2)	RX	FMD0005	R
TUONO V4 R APRC ABS	1000	2014 →	FMD0111 (x2)	RX	FMD0005	R
TUONO V4 FACTORY	1100	2015 → 2016	FMD0352 (x2)	RX		
TUONO V4 RR	1100	2015 → 2016	FMD0352 (x2)	RX		
CAPONORD	1200	2013 → 2014	FMD0111 (x2)	RX	FMD0005	R
CAPO NORD RALLY	1200	2013 → 2015			FMD0005	R
CAPONORD	1200	2015 → 2017	FMD0111 (x2)	RX		
CAPONORD TRAVEL PACK ABS	1200	2016 → 2017	FMD0111 (x2)	RX		
DORSODURO	1200	2011 → 2013	FMD0111 (x2)	RX		
DORSODURO ABS	1200	2011 → 2012	FMD0111 (x2)	RX		

BENELLI

491 all models	50	1997 →	FMD0097	R		
GRIDO	50	2012 → 2013	FMD0097	R		
K2 all models	50	1998 →	FMD0097	R		
PEPE	50	1999 → 2004	FMD0447	R		
K2	100	1999 →	FMD0097	R		
NAKED	100	1999 → 2002	FMD0097	R		
PEPE LX	100	2002 →	FMD0447	R		
ADIVA	125	2000 → 2002	FMD0007	R	FMD0413	R
VELVET	125	1999 → 2004	FMD0447	R		
VELVET TOURING	125	2002 → 2003	FMD0447	R		
ADIVA	150	2000 → 2002	FMD0007	R	FMD0413	R
VELVET	150	1999 → 2004	FMD0447	R		
VELVET TOURING	150	2002 → 2003	FMD0447	R		
VELVET	250	1999 →	FMD0326	R		
VELVET TOURING	250	2001 →	FMD0326	R		
BN 302	300	2015 → 2016			FMD0207	R
VELVET DUSK	400	2003 →	FMD0326	R	FMD0022	R
LEONCINO	500	2017 → 2018	FMD0111 (x2)	RX		
BN 600	600	2015 → 2017	FMD0111 (x2)	RX	FMD0207	R
BN 600 GT	600	2015 → 2017	FMD0111 (x2)	RX	FMD0207	R
CENTURY RACER	899	2011 → 2015	FMD0111 (x2)	RX	FMD0207	R
TNT	899	2008 → 2016	FMD0111 (x2)	RX	FMD0207	R
TNT S	899	2008 → 2011	FMD0111 (x2)	RX	FMD0207	R
TRE K	899	2011 → 2016	FMD0111 (x2)	RX	FMD0207	R
TORNADO TRE	900	2001 → 2002	FMD0111 (x2)	RX		
TORNADO TRE	900	2003 → 2006	FMD0352 (x2)	RX	FMD0005	R
TORNADO TRE RS	900	2004 → 2006	FMD0352 (x2)	RX	FMD0005	R
TNT	1100	2004 →	FMD0111 (x2)	RX	FMD0207	R
CAFE RACER	1130	2006 → 2015	FMD0352 (x2)	RX	FMD0207	R
CENTURY RACER	1130	2011 → 2014	FMD0111 (x2)	RX	FMD0207	R
TITANIUM	1130	2005 → 2007	FMD0352 (x2)	RX	FMD0207	R
TNT	1130	2004 → 2006	FMD0111 (x2)	RX	FMD0207	R
TNT RS	1130	2005 → 2007	FMD0352 (x2)	RX	FMD0207	R
TNT R160	1130	2011 →	FMD0111 (x2)	RX	FMD0207	R
TORNADO NAKED TRE R	1130	2016 →	FMD0352 (x2)	RX	FMD0207	R
TORNADO	1130	2006 →	FMD0352 (x2)	RX		
TRE K	1130	2007 → 2017	FMD0111 (x2)	RX	FMD0207	R

BETA

ARK RR	50	2006 → 2011	FMD0002	R	FMD0002	R
ARK PADDOCK	50	2008 → 2011	FMD0002	R	FMD0002	R
ARK TRIBE	50	2008 → 2012			FMD0002	R
ARK RAZOR / FACTORY	50	2010 → 2011	FMD0002	R	FMD0002	R
ARK RAZOR / FACTORY	50	2012 → 2012			FMD0002	R
ARK AC PADDOCK / HB	50	2014 → 2014	FMD0002	R		
ARK LC K	50	1999 → 2006	FMD0002	R	FMD0002	R
ARK AC/LC	50	1996 → 2014	FMD0002	R	FMD0002	R
CHRONO	50	1992 → 1994	FMD0002	R		

10002**FERODO**

RACING

Updated on November 2020



DISCS TYPE



DISCS TYPE

...BETA

CHRONO ruota da 13	50	1994 →	FMD0002	R		
MX R ENDURO	50	1995 → 1996			FMD0317	R
QUADRA	50	1995 → 1996	FMD0002	R		
RK 6 - E	50	1995 → 1997			FMD0317	R
RK ADVENTURE	50	1995 → 1996			FMD0317	R
RK 6 T	50	1998 →	FMD0315	R		
TEMPO 13	50	1995 → 1996	FMD0002	R		
EIKON	125	1999 →	FMD0003	R		
REV 3	125	2000 → 2008	FMD0064	R		
REV 3	200	2000 → 2008	FMD0064	R		
REV 3	250	2000 → 2008	FMD0064	R		
RR 250	250	2005 → 2012			FMD0335	R
RR 250	250	2013 →	FMD0017	RF/MXR	FMD0459	RS/R
RR 2T ENDURO 250	250	2014 →	FMD0017	RF/MXR	FMD0459	RS/R
REV 3	270	2000 → 2008	FMD0064	R		
RR	300	2013 →	FMD0017	RF/MXR		
RR 2T ENDURO 300	300	2013 →	FMD0017	RF/MXR	FMD0459	RS/R
RR 4T ENDURO 350	350	2012 → 2012			FMD0335	R
RR 4T ENDURO 350	350	2013 →	FMD0017	RF/MXR	FMD0459	RS/R
RR EFI	350	2015 →	FMD0017	RF/MXR		
RR EFI RACING	350	2015 →	FMD0017	RF/MXR		
RR	390	2015 →	FMD0017	RF/MXR		
RR 4T ENDURO 390	390	2015 →	FMD0017	RF/MXR	FMD0459	RS/R
RR	400	2005 → 2012			FMD0335	R
RR 4T ENDURO 400	400	2013 → 2014	FMD0017	RF/MXR	FMD0459	RS/R
RR 4T ENDURO 430	430	2015 →	FMD0017	RF/MXR	FMD0459	RS/R
RR RACING	430	2015 →	FMD0017	RF/MXR		
RR	450	2005 → 2012			FMD0335	R
RR CROSS COUNTRY	450	2012 →			FMD0335	R
RR CROSS 450	450	2013 → 2014	FMD0017	RF/MXR	FMD0459	RS/R
RR 4T ENDURO 450	450	2013 → 2015	FMD0017	RF/MXR	FMD0459	RS/R
RR 4T ENDURO 480	480	2015 →	FMD0017	RF/MXR	FMD0459	RS/R
RR RACING	480	2015 →	FMD0017	RF/MXR		
RR 4T ENDURO 498	498	2012 → 2014	FMD0017	RF/MXR	FMD0459	RS/R
RR 4T FACTORY 498	498	2012 →	FMD0017	RF/MXR	FMD0459	RS/R
RR	525	2005 → 2012			FMD0335	R

BIMOTA

YB7	400	1989 →	FMD0111 (x2)	RX		
V-DUE	500	1997 → 2000	FMD0111 (x2)	RX		
YB9	600	1997 → 2000	FMD0111 (x2)	RX		
BB1 SUPERMONO	650	1996 → 2000	FMD0111	RX		
TESI 1D 851	851	1990 → 1991	FMD0111 (x2)	RX		
DB2 SR	904	1993 → 2000	FMD0111 (x2)	RX		
DB3 MANTRA	904	1995 → 2000	FMD0111 (x2)	RX		
DB4	904	1998 → 1999	FMD0111 (x2)	RX		
DIECI BIPOSTO	1000	1992 → 1995	FMD0111 (x2)	RX		
SB8R	1000	1997 → 2000	FMD0111 (x2)	RX		
SB8K GOBERT	1000	2006 →	FMD0111 (x2)	RX		
SB8K SANTAMONICA	1000	2006 →	FMD0352 (x2)	RX		
SB6	1100	1996 → 2000	FMD0111 (x2)	RX		
SB6R	1100	1998 → 2000	FMD0111 (x2)	RX		

BMW

C 1	125	1999 →	FMD0170	R	FMD0170	R
C 1	200	2001 →	FMD0170	R	FMD0170	R
R 45	450	1978 → 1986	FMD0080 (x2)	R		
F 650	650	1994 → 2001			FMD0207	R
F 650 ST	650	1997 → 2001			FMD0207	R
F 650 GS DAKAR	650	1999 → 2007			FMD0207	R
F 650 GS	650	2001 → 2007			FMD0207	R
F 650 GS ABS	650	2001 → 2007			FMD0207	R
F 650 CS	650	2002 → 2007			FMD0207	R
G 650 X Moto	650	2007 → 2009	FMD0111	RX		
G 650 GS	650	2009 → 2016			FMD0207	R
G 650 GS SERTA0	650	2012 → 2014			FMD0207	R
R 65	650	1978 → 1980	FMD0080	R		
R 65 LS	650	1982 → 1988	FMD0080 (x2)	R		
R 65/1	650	1986 →	FMD0080	R		
K 75	750	1984 → 1996	FMD0081 (x2)	R		
K 75 S	750	1985 → 1988	FMD0081 (x2)	R	FMD0081	R
K 75 C	750	1985 → 1991	FMD0081 (x2)	R		
K 75 S	750	1989 → 1992	FMD0081 (x2)	R		
K 75 RT	750	1990 → 1996	FMD0081 (x2)	R	FMD0081	R



DISCS TYPE



DISCS TYPE

...BMW

K 75 S	750	1993 → 1996	FMD0081 (x2)	R	FMD0081	R
F 800 S	800	2006 → 2010	FMD0083 (x2)	R	FMD0407	R
F 800 ST	800	2006 → 2012	FMD0083 (x2)	R	FMD0407	R
F 650 GS (K72)	800	2008 → 2012			FMD0407	R
F 650 GS ABS (K72)	800	2008 → 2011			FMD0407	R
F 800 R	800	2009 → 2019	FMD0083 (x2)	R	FMD0407	R
F 800 GS	800	2009 → 2018			FMD0407	R
F 800 GS ADVENTURE ABS	800	2012 → 2019			FMD0407	R
F 800 GT ABS	800	2013 → 2017	FMD0083 (x2)	R	FMD0407	R
F 700 GS ABS	800	2013 → 2018			FMD0407	R
PARIS DAKAR	800	1981 → 1987	FMD0080 (x2)	R		
R 80	800	1981 → 1993	FMD0081 (x2)	R		
R 80 RT	800	1985 → 1994	FMD0081 (x2)	R		
R 80 GS	800	1988 → 1990	FMD0080 (x2)	R		
R 80 GS Paris Dakar	800	1988 → 1994	FMD0081	R		
R 80 R ROADSTER	800	1992 → 1993	FMD0081 (x2)	R		
F 850 GS	850	2018 →	FMD0450 (x2)	R	FMD0407	R
F 850 GS Adventure	850	2019 →	FMD0450 (x2)	R	FMD0407	R
R 850 R	850	1994 → 2003	FMD0206 (x2)	RF	FMD0075	R
R 850 RT	850	1995 → 2001	FMD0206 (x2)	RF	FMD0075	R
R 850 C	850	1998 → 2001	FMD0450 (x2)	R	FMD0075	R
R 850 GS	850	1998 → 2007	FMD0450 (x2)	R	FMD0075	R
R 850 RT Integral ABS	850	2001 → 2004	FMD0083 (x2)	R	FMD0075	R
R 850 R	850	2004 → 2007	FMD0083 (x2)	R	FMD0075	R
F 750 GS	853	2018 →	FMD0450 (x2)	R	FMD0407	R
K 100	1000	1983 → 1989	FMD0081 (x2)	R	FMD0081	R
K 100 RS	1000	1984 → 1989	FMD0081 (x2)	R	FMD0081	R
K 100 RT	1000	1984 → 1989	FMD0081 (x2)	R	FMD0081	R
K 100 RS 16V	1000	1989 → 1993	FMD0206 (x2)	RF	FMD0081	R
K1	1000	1989 → 1993	FMD0206 (x2)	RF	FMD0081	R
K 100 LT ABS	1000	1990 → 1991	FMD0081 (x2)	R	FMD0081	R
K 100 LT LIMITED	1000	1991 → 1992	FMD0081 (x2)	R	FMD0081	R
R 100 RS	1000	1976 → 1980	FMD0080 (x2)	R	FMD0080	R
R 100	1000	1981 → 1989	FMD0080 (x2)	R	FMD0080	R
R 100 CS	1000	1981 → 1989	FMD0080 (x2)	R		
R 100 GS	1000	1987 → 1994	FMD0081	R		
R 100 GS PD	1000	1989 → 1995	FMD0081	R		
R 100 GS MYSTIC	1000	1991 →	FMD0081 (x2)	R		
R 100 RT	1000	1991 → 1994	FMD0081 (x2)	R		
R 100 R	1000	1992 → 1996	FMD0081 (x2)	R	FMD0081	R
R 100 R ROADSTER	1000	1992 → 1995	FMD0081	R		
S 1000 R ABS	1000	2013 → 2019	FMD0083 (x2)	R		
S 1000 XR	1000	2015 → 2019	FMD0083 (x2)	R	FMD0407	R
K 1100 LT	1100	1992 → 2000	FMD0206 (x2)	RF	FMD0081	R
K 1100 RS	1100	1993 → 1996	FMD0206 (x2)	RF	FMD0081	R
R 1100 GS	1100	1994 → 2001	FMD0450 (x2)	R	FMD0075	R
R 1100 RS	1100	1994 → 2001	FMD0206 (x2)	RF	FMD0081	R
R 1100 RT	1100	1994 → 2001	FMD0206 (x2)	RF	FMD0075	R
R 1100 RT ABS	1100	1994 → 2001	FMD0206 (x2)	RF	FMD0075	R
R 1100 R	1100	1995 → 2001	FMD0206 (x2)	RF	FMD0075	R
R 1100 S	1100	1998 → 2000	FMD0450 (x2)	R	FMD0075	R
R 1100 S	1100	2001 → 2006	FMD0083 (x2)	R	FMD0075	R
R 1100 S Boxer Cup Replika	1100	2003 → 2006	FMD0083 (x2)	R	FMD0075	R
R 1150 GS	1150	1999 → 2001	FMD0450 (x2)	R	FMD0075	R
R 1150 RT	1150	2001 → 2005	FMD0083 (x2)	R	FMD0075	R
R 1150 GS ADVENTURE	1150	2002 → 2005	FMD0450 (x2)	R	FMD0075	R
R 1150 GS (Brembo caliper)	1150	2002 → 2004	FMD0450 (x2)	R	FMD0075	R
R 1150 R ROCKSTER	1150	2003 → 2006	FMD0083 (x2)	R	FMD0075	R
R 1150 R	1150	2001 → 2006	FMD0083 (x2)	R	FMD0075	R
R 1150 RS	1150	2001 → 2005	FMD0083 (x2)	R	FMD0075	R
R 1150 RT ABS	1150	2001 → 2005	FMD0083 (x2)	R	FMD0075	R
HP2	1200	2006 → 2009	FMD0450	R	FMD0407	R
HP2 Megamoto	1200	2007 → 2010	FMD0083	R	FMD0407	R
HP2 SPORT	1200	2008 → 2011	FMD0083 (x2)	R	FMD0407	R
K 1200 R	1200	2004 → 2008	FMD0083 (x2)	R	FMD0407	R
K 1200 S / ABS	1200	2004 → 2007	FMD0083 (x2)	R	FMD0407	R
K 1200 RS	1200	1997 → 2000	FMD0450 (x2)	R		
K 1200 LT	1200	1999 → 2000	FMD0450 (x2)	R		
K 1200 GT ABS	1200	2002 → 2007	FMD0083 (x2)	R		
K 1200 RS	1200	2001 → 2006	FMD0083 (x2)	R		
K 1200 LT ABS	1200	2001 → 2009	FMD0083 (x2)	R		
R 1200 C CLASSIC	1200	2003 →	FMD0450 (x2)	R		
R 1200 GS (R12)	1200	2004 → 2012	FMD0450 (x2)	R	FMD0407	R
R 1200 GS ABS	1200	2004 → 2012	FMD0450 (x2)	R	FMD0407	R
R 1200 RT	1200	2005 → 2013	FMD0083 (x2)	R	FMD0407	R
R 1200 ST	1200	2005 → 2008	FMD0083 (x2)	R	FMD0407	R

BMW

10004



DISCS TYPE



DISCS TYPE

...BMW

R 1200 GS ADVENTURE	1200	2006 → 2013	FMD0450 (x2)	R	FMD0407	R
R 1200 R	1200	2006 → 2017	FMD0083 (x2)	R	FMD0407	R
R 1200 S	1200	2006 → 2008	FMD0083 (x2)	R	FMD0407	R
R 1200 GS ABS (K50)	1200	2013 → 2018	FMD0450 (x2)	R	FMD0473	R
R 1200 RT	1200	2014 → 2018	FMD0083 (x2)	R	FMD0473	R
R 1200 GS ADVENTURE ABS (K51)	1200	2014 → 2018	FMD0450 (x2)	R	FMD0473	R
R 1200 RS	1200	2015 → 2018	FMD0083 (x2)	R	FMD0473	R
R 1200 GS RALLYE	1200	2017 → 2018	FMD0450 (x2)	R	FMD0473	R
R 1200 GS Exclusive	1200	2017 → 2018	FMD0450 (x2)	R	FMD0473	R
R 1200 C	1200	1997 → 2001	FMD0450 (x2)	R		
R 1200 CL	1200	2002 → 2006	FMD0450 (x2)	R		
R 1200 R CLASSIC	1200	2011 → 2012	FMD0083 (x2)	R	FMD0407	R
R NINE T	1200	2014 → 2019	FMD0083 (x2)	R	FMD0407	R
R NINE T PURE	1200	2014 → 2019	FMD0083 (x2)	R	FMD0407	R
R NINE T RACER	1200	2014 → 2019	FMD0083 (x2)	R	FMD0407	R
R NINE T SCRAMBLER	1200	2017 → 2019	FMD0083 (x2)	R	FMD0407	R
R NINE T URBAN G/S	1200	2017 → 2019	FMD0083 (x2)	R	FMD0407	R
R 1250 GS	1254	2019 →	FMD0450 (x2)	R	FMD0473	R
R 1250 GS ADVENTURE	1254	2019 →	FMD0450 (x2)	R	FMD0473	R
R 1250 R	1254	2019 →	FMD0450 (x2)	R	FMD0473	R
R 1250 RS	1254	2019 →	FMD0450 (x2)	R	FMD0473	R
R 1250 RT	1254	2019 →	FMD0450 (x2)	R	FMD0473	R
K 1300 R - ABS	1300	2008 → 2014	FMD0083 (x2)	R	FMD0407	R
K 1300 S	1300	2009 → 2015	FMD0083 (x2)	R	FMD0407	R
K 1300 GT	1300	2009 → 2010	FMD0083 (x2)	R		
K 1600 GT	1649	2011 → 2019	FMD0083 (x2)	R		
K 1600 GTL	1649	2011 → 2019	FMD0083 (x2)	R		
K 1600 GTL EXCLUSIVE	1649	2014 → 2017	FMD0083 (x2)	R		
K 1600 B	1649	2017 → 2019	FMD0083 (x2)	R		
K 1600 B Grand America	1649	2018 →	FMD0083 (x2)	R		

BS VILLA

AX	50	1993 →	FMD0001	R		
GZ	50	1993 →	FMD0001	R		

BUELL

1200 all models	1200	1994 → 1997			FMD0009	R
M2 CYCLONE	1200	1998 → 2002			FMD0009	R
S1 LIGHTNING	1200	1998 → 2002			FMD0009	R
S1 WHITELIGHTNING	1200	1998 → 2002			FMD0009	R
S3 THUNDERBOLT	1200	1998 → 2002			FMD0009	R
S3T THUNDERBOLT	1200	1998 → 2002			FMD0009	R
X1 LIGHTNING	1200	1999 → 2002			FMD0009	R

CAGIVA

CITY	50	1992 → 1994	FMD0006	R		
MITO	50	1998 → 2001			FMD0312	R
PRIMA R	75	1998 → 2001			FMD0312	R
CITY	80	1993 →	FMD0006	R		
FRECCIA C12R	125	1989 → 1991	FMD0121	RX		
MITO	125	1991 → 1994	FMD0111	RX		
MITO EV	125	1995 → 2007	FMD0111	RX		
MITO SP525	125	2006 → 2010	FMD0111	RX		
PASSING	125	1994 →	FMD0006	R		
PLANET	125	1997 → 2007	FMD0111	RX		
RAPTOR	125	2003 → 2010	FMD0111	RX		
SUPERCITY	125	1992 → 2000	FMD0111	RX		
CANYON	500	1996 → 2000	FMD0089	R		
CANYON	600	1995 → 1999	FMD0089	R		
RIVER	600	1995 → 1999	FMD0111	RX		
RAPTOR	650	2001 → 2007	FMD0132 (x2)	RX		
ELEFANT	750	1994 → 1995	FMD0089	R	FMD0009	R
ELEFANT I.E.	900	1990 → 1992	FMD0093	R	FMD0009	R
ELEFANT I.E. - GT - AC	900	1991 → 1994	FMD0089	R		
ELEFANT I.E.	900	1993 → 1996			FMD0009	R
GRAN CANYON	900	1999 → 2004	FMD0089 (x2)	R	FMD0009	R
NAVIGATOR	1000	2000 → 2005	FMD0089 (x2)	R	FMD0009	R
V-RAPTOR	1000	2000 → 2006	FMD0132 (x2)	RX		
XTRA-RAPTOR	1000	2002 → 2004	FMD0132 (x2)	RX		
RAPTOR	1000	2000 → 2006	FMD0132 (x2)	RX		



DISCS TYPE



DISCS TYPE

CCM

DS	644	2002 → 2006					
R30	644	2002 → 2006					

FMD0184	MXR
FMD0184	MXR

CPI

ARAGON ALL MODELS	50	2006 → 2009	FMD0097	R			
BABY / BABJ	50	2002 →	FMD0097	R			
FORMULA BASCI / R	50	2004 →	FMD0097	R			
HUSSAR ALL MODELS / MARS	50	2001 →	FMD0097	R			
OLIVER / CITY / SPORT	50	2003 → 2012	FMD0097	R			
OLIVER CITY	125	2006 → 2007	FMD0097	R			

DAELIM

S-Five 50	50	2006 → 2010	FMD0097	R			
AROMA	125	2016 →	FMD0097	R			
BESBI	125	2011 → 2012	FMD0097	R			

DERBI

FENIX	50	1995 → 1998				FMD0172	R
GP1 OPEN	50	2005 → 2011	FMD0043	R			
GPR R	50	1997 → 2001				FMD0312	R
DRD Racing SM PRO EU2	50	2005 → 2009	FMD0365	R			
DRD SM PRO EU2	50	2005 → 2008	FMD0365	R			
GPR NUDE	50	2006 → 2008	FMD0365	R			
GPR NUDE TUNING	50	2006 → 2008	FMD0365	R			
GPR RACING EU2	50	2006 →	FMD0365	R			
GPR REPLICIA - R EU2	50	2006 →	FMD0365	R			
GPR REPLICIA 2T	50	2007 →	FMD0365	R			
GPR REPLICIA PESEK EU2	50	2007 →	FMD0365	R			
GPR NUDE SPORT	50	2008 →	FMD0365	R			
GPR R EU2 - REPLICIA EU2	50	2008 →	FMD0365	R			
SENDA EX	50	1995 → 1997				FMD0172	R
SENDA R	50	1997 → 1997				FMD0172	R
SENDA SUPERMOTARD	50	1997 → 1999				FMD0172	R
SENDA R	50	1998 → 1999				FMD0172	R
SENDA L	50	1999 →				FMD0172	R
SENDA SR	50	1999 → 2000				FMD0172	R
SENDA R XTREAM	50	2000 → 2001				FMD0172	R
SENDA SM XTREAM	50	2000 → 2001				FMD0172	R
SENDA SR	50	2001 →				FMD0172	R
SENDA R RACER	50	2002 →				FMD0172	R
SENDA SM RACER	50	2002 →				FMD0172	R
VARIANT SPORT 2T	50	2014 → 2018	FMD0007	R			
BOULEVARD S	125	2007 →	FMD0050	R			
GPR NUDE	125	2004 → 2006	FMD0365	R			
GPR RACING	125	2004 → 2006	FMD0365	R			
RAMBLA	125	2009 → 2011	FMD0050	R			
VARIANT SPORT 4T	125	2014 → 2017	FMD0007	R			
RAMBLA	250	2009 →	FMD0050	R			
RAMBLA i	300	2010 → 2012	FMD0050 (x2)	R		FMD0003	R

DUCATI

JUNIOR SS	350	1991 → 1993	FMD0111	RX		FMD0023	R
MONSTER	400	1994 → 1999	FMD0111	RX		FMD0023	R
MONSTER	400	2001 → 2006	FMD0111	RX		FMD0023	R
SS SUPERSPORT	400	1992 → 1997	FMD0111	RX		FMD0023	R
SS SUPERSPORT JUNIOR	400	1992 → 1997	FMD0111 (x2)	RX		FMD0023	R
M MONSTER	600	1994 → 2002	FMD0111	RX		FMD0023	R
MONSTER	600	1994 → 2002	FMD0111	RX		FMD0023	R
SS SUPERSPORT	600	1994 → 2000	FMD0111	RX		FMD0023	R
MONSTER	620	2002 → 2005	FMD0111 (x2)	RX		FMD0023	R
MONSTER double disk	620	2005 → 2006				FMD0023	R
MONSTER single disk	620	2005 → 2006	FMD0111	RX		FMD0023	R
MULTISTRADA double disk	620	2005 → 2006				FMD0023	R
MULTISTRADA single disk	620	2005 → 2006	FMD0111	RX		FMD0023	R
SPORT	620	2003 → 2004	FMD0111 (x2)	RX		FMD0023	R
SS SUPERSPORT	620	2002 → 2005	FMD0111 (x2)	RX		FMD0023	R
MONSTER	695	2006 → 2008				FMD0023	R
MONSTER	696	2008 → 2014	FMD0111 (x2)	RX		FMD0023	R
MONSTER ABS	696	2010 → 2014	FMD0111 (x2)	RX		FMD0023	R
748 BIPOSTO - SP	748	1995 → 2001				FMD0180	R
748	748	2002 →				FMD0180	R

CCM

10006

FERODO

RACING

Updated on November 2020



DISCS TYPE



DISCS TYPE

...DUCATI

748 BIPOSTO	748	2003 →				FMD0180	R
748 BIPOSTO	748	1995 → 2002	FMD0111 (x2)	RX		FMD0180	R
748 SPS	748	1998 → 1999	FMD0111 (x2)	RX		FMD0180	R
748 R	748	2001 → 2002	FMD0147 (x2)	RX		FMD0180	R
748 SP	748	1995 → 1997	FMD0111 (x2)	RX		FMD0180	R
748 S	748	1999 → 2002	FMD0111 (x2)	RX		FMD0180	R
748 R	748	2000 → 2000	FMD0111 (x2)	RX		FMD0180	R
749	748	2003 → 2006				FMD0389	R
749 DARK	748	2004 → 2006				FMD0389	R
749 S	748	2003 → 2006				FMD0389	R
749 R	748	2004 → 2006				FMD0389	R
M MONSTER	750	1996 → 2001	FMD0111 (x2)	RX		FMD0023	R
MONSTER	750	1994 → 2001	FMD0111 (x2)	RX		FMD0023	R
SPORT	750	2000 → 2002	FMD0111	RX		FMD0023	R
SS SUPERSPORT	750	1991 → 2002	FMD0111 (x2)	RX		FMD0023	R
MONSTER	795	2013 →				FMD0390	R
HYPERMOTARD 796	800	2010 → 2012				FMD0390	R
MONSTER S2R	800	2005 → 2007				FMD0390	R
MONSTER S2R DARK	800	2005 → 2006				FMD0390	R
MONSTER 796	800	2011 → 2014				FMD0390	R
MONSTER	800	2003 → 2004	FMD0111 (x2)	RX		FMD0023	R
SPORT	800	2003 → 2004	FMD0111 (x2)	RX		FMD0023	R
SS SUPERSPORT	800	2003 → 2005	FMD0111 (x2)	RX		FMD0023	R
MONSTER 797 ABS	803	2017 →				FMD0023	R
MONSTER	821	2015 →				FMD0023	R
MONSTER ABS	821	2015 → 2017				FMD0023	R
MONSTER DARK ABS	821	2015 → 2016				FMD0023	R
MONSTER STRIPE ABS	821	2015 → 2017				FMD0023	R
848	848	2008 → 2010				FMD0390	R
STREETFIGHTER	848	2012 →				FMD0390	R
STREETFIGHTER S	848	2012 →				FMD0390	R
848 EVO	850	2011 → 2012				FMD0390	R
851 STRADA - SP	851	1988 → 1991	FMD0111 (x2)	RX		FMD0023	R
888 SP	888	1990 → 1993	FMD0111 (x2)	RX		FMD0023	R
888 DESMOQUATTRO	888	1993 → 1994	FMD0111 (x2)	RX		FMD0023	R
MH	900	2001 → 2002				FMD0180	R
M MONSTER	900	1993 → 2001	FMD0111 (x2)	RX		FMD0023	R
MONSTER	900	1993 → 2004	FMD0111 (x2)	RX		FMD0023	R
SL 900 SUPERLIGHT	900	1991 → 1997	FMD0111 (x2)	RX		FMD0023	R
SPORT	900	2002 →	FMD0111 (x2)	RX		FMD0023	R
SS SUPERSPORT	900	1991 → 2002	FMD0111 (x2)	RX		FMD0023	R
PASO 906	904	1989 → 1990				FMD0023	R
PASO 907 I.E.	904	1990 → 1991	FMD0121 (x2)	RX		FMD0023	R
916 SP	916	1994 → 1996	FMD0111 (x2)	RX		FMD0180	R
916 BIPOSTO SENNA	916	1994 → 1998				FMD0180	R
916 SPS	916	1997 → 1998	FMD0111 (x2)	RX		FMD0180	R
916 BIPOSTO	916	1994 → 1998	FMD0111 (x2)	RX		FMD0180	R
MONSTER S4	916	2001 → 2003	FMD0111 (x2)	RX		FMD0023	R
ST4	916	1998 → 2004	FMD0111 (x2)	RX		FMD0023	R
916 RACING	926	1994 → 1997				FMD0180	R
Hyperstrada 939	937	2016 →				FMD0468	R
Supersport S	937	2017 →				FMD0468	R
Supersport	937	2017 →				FMD0468	R
ST2	944	1997 → 2003	FMD0111 (x2)	RX		FMD0023	R
ST3	992	2004 → 2006	FMD0111 (x2)	RX		FMD0023	R
996 BIPOSTO	996	1999 → 2001	FMD0111 (x2)	RX		FMD0180	R
996 S	996	2001 →	FMD0111 (x2)	RX		FMD0180	R
996 SPS	996	1999 → 2000	FMD0147 (x2)	RX		FMD0180	R
996 R	996	2001 →	FMD0147 (x2)	RX		FMD0180	R
MONSTER S4R	996	2003 → 2006	FMD0111 (x2)	RX		FMD0390	R
ST4 S ABS	996	2003 → 2003	FMD0111 (x2)	RX		FMD0023	R
ST4 S ABS	996	2004 → 2006				FMD0023	R
ST4 S	996	2001 → 2005	FMD0111 (x2)	RX		FMD0023	R
998 BIPOSTO	998	2002 → 2003	FMD0111 (x2)	RX		FMD0180	R
998 S (four pads)	998	2002 → 2003	FMD0352 (x2)	RX		FMD0180	R
998 S (two pads)	998	2002 → 2003	FMD0111	RX		FMD0180	R
998 R	998	2002 → 2003	FMD0147 (x2)	RX		FMD0180	R
999	998	2003 → 2006				FMD0389	R
999 S	998	2002 → 2007				FMD0389	R
S4RS Testastretta MONSTER	998	2006 → 2007				FMD0390	R
S4R Testastretta MONSTER	998	2007 →				FMD0390	R
999 R	999	2003 → 2006				FMD0389	R
GT	1000	2006 → 2010	FMD0111 (x2)	RX		FMD0023	R
GT TOURING	1000	2009 →	FMD0111 (x2)	RX		FMD0023	R
MONSTER S	1000	2003 → 2005	FMD0111 (x2)	RX		FMD0023	R
MONSTER S2R	1000	2006 → 2007	FMD0111 (x2)	RX		FMD0390	R

DUCATI



DISCS TYPE



DISCS TYPE

...DUCATI

MONSTER S4RS	1000	2006 → 2008			FMD0390	R
MONSTER S4R	1000	2007 → 2008			FMD0390	R
MONSTER S2R	1000	2008 → 2008			FMD0390	R
MONSTER S4RS TRICOLORE	1000	2008 →			FMD0390	R
MONSTER	1000	2003 → 2005	FMD0111 (x2)	RX	FMD0023	R
MULTISTRADA DS S	1000	2005 →			FMD0390	R
MULTISTRADA DS	1000	2005 →			FMD0390	R
MULTISTRADA S	1000	2006 →			FMD0390	R
MULTISTRADA	1000	2003 → 2006			FMD0390	R
PAUL SMART LE	1000	2006 → 2007	FMD0111 (x2)	RX	FMD0023	R
SPORT	1000	2006 → 2008	FMD0111 (x2)	RX	FMD0023	R
SPORT S	1000	2007 → 2009	FMD0111 (x2)	RX	FMD0023	R
SS SUPERSPORT	1000	2003 → 2006	FMD0111 (x2)	RX	FMD0023	R
ST3	1000	2004 → 2006	FMD0111 (x2)	RX	FMD0023	R
ST3 S ABS	1000	2006 → 2007	FMD0111 (x2)	RX	FMD0023	R
HYPERMOTARD	1100	2008 → 2009			FMD0390	R
HYPERMOTARD S	1100	2008 → 2009			FMD0390	R
HYPERMOTARD EVO SP	1100	2010 → 2012			FMD0390	R
HYPERMOTARD EVO	1100	2011 → 2012			FMD0390	R
MONSTER 1100 - ABS	1100	2009 → 2010			FMD0390	R
MONSTER 1100 S	1100	2009 → 2010			FMD0390	R
MONSTER S ABS	1100	2010 →			FMD0390	R
MONSTER EVO	1100	2012 → 2013			FMD0390	R
MONSTER EVO - EVO ABS	1100	2012 → 2013			FMD0390	R
MONSTER DIESEL	1100	2013 →			FMD0390	R
MONSTER EVO ANNIVERSARY	1100	2013 →			FMD0390	R
MULTISTRADA	1100	2007 → 2009			FMD0390	R
MULTISTRADA S	1100	2007 → 2009			FMD0390	R
Panigale V4	1103	2018 →			FMD0468	R
Panigale V4 S	1103	2018 →			FMD0468	R
Panigale V4 Speciale	1103	2018 →			FMD0468	R
Monster 1200	1198	2014 →			FMD0468	R
Monster 1200 S	1198	2014 →			FMD0468	R
Monster 1200 S Stripe	1198	2014 →			FMD0468	R
Monster 1200 R	1198	2016 →			FMD0468	R
Multistrada 1200 S Touring	1198	2010 →			FMD0468	R
Multistrada 1200 S Pikes Peak	1198	2010 →			FMD0468	R
Multistrada 1200 S Sport	1198	2010 →			FMD0468	R
Multistrada 1200 S	1198	2013 →			FMD0468	R
Multistrada 1200 S Granturismo	1198	2013 →			FMD0468	R
1199 Panigale S	1198	2012 →			FMD0468	R
1199 Panigale S Tricolore	1198	2012 → 2014			FMD0468	R
1199 Panigale	1198	2012 →			FMD0468	R
1199 Panigale R	1198	2013 → 2017			FMD0468	R
1299 Panigale S Anniversario	1285	2016 → 2016			FMD0468	R
1299 Superleggera	1285	2017 → 2017			FMD0468	R

FANTIC MOTOR

BIG WHEELS	50	1991 → 1994	FMD0001	R		
GRINTA	50	1995 → 2000	FMD0001	R		

GARELLI

BIG WHEEL	50	1993 →	FMD0001	R		
BIP-RACING	50	1994 →	FMD0001	R		
GRINTA	50	1995 →	FMD0001	R		
PONY SR	50	1992 →	FMD0001	R		
QUEENIE	50	1995 →	FMD0001	R		

GAS GAS

EC	125	1996 → 2011			FMD0184	MXR
EC- MC	125	1996 →			FMD0184	MXR
EC RACING	125	2013 → 2014			FMD0184	MXR
MC	125	1996 → 2009			FMD0184	MXR
TXT	125	2001 → 2003	FMD0375	R	FMD0378	R
TXT PRO	125	2004 → 2013	FMD0377	R	FMD0378	R
TXT PRO RACING	125	2014 →	FMD0332	R	FMD0378	R
EC	200	2000 → 2014			FMD0184	MXR
HOBBY	200	2007 →			FMD0184	MXR
TXT	200	2000 → 2003	FMD0375	R	FMD0378	R
TXT PRO	200	2004 → 2013	FMD0377	R	FMD0378	R
EC	250	1996 → 2010			FMD0184	MXR
EC- MC	250	1996 →			FMD0184	MXR



CC



DISCS TYPE



DISCS TYPE

...GAS GAS

EC 2T	250	2011 → 2014			FMD0184	MXR
EC 4T	250	2011 → 2014			FMD0184	MXR
EC RACING	250	2012 → 2013			FMD0184	MXR
EC F RACING	250	2013 → 2014			FMD0184	MXR
MC	250	1996 → 2009			FMD0184	MXR
TXT	250	2000 → 2003	FMD0375	R	FMD0378	R
TXT PRO	250	2004 → 2013	FMD0377	R	FMD0378	R
TXT PRO RACING	250	2014 →	FMD0332	R	FMD0378	R
TXT	280	2000 → 2003	FMD0375	R	FMD0378	R
TXT	280	2004 → 2013	FMD0377	R	FMD0378	R
TXT PRO RACING	280	2014 →	FMD0332	R	FMD0378	R
EC	300	1996 → 2012			FMD0184	MXR
EC- MC	300	1996 →			FMD0184	MXR
EC RACING	300	2012 → 2013			FMD0184	MXR
EC 2T	300	2013 → 2014			FMD0184	MXR
EC F RACING	300	2013 → 2014			FMD0184	MXR
MC	300	1996 → 2009			FMD0184	MXR
TXT	300	2004 → 2009	FMD0377	R	FMD0378	R
TXT PRO RACING	300	2014 →	FMD0332	R	FMD0378	R
EC	400	2002 → 2002			FMD0184	MXR
EC	400	2006 → 2007			FMD0184	MXR
FSE	400	2002 →			FMD0184	MXR
MC	400	2002 → 2002			FMD0184	MXR
MC	400	2006 → 2007			FMD0184	MXR
PAMPERA	400	2006 → 2007			FMD0184	MXR
EC	450	2003 → 2007			FMD0184	MXR
EC F	450	2013 → 2014			FMD0184	MXR
FSE	450	2003 → 2006			FMD0184	MXR
FSR	450	2007 →			FMD0184	MXR
MC	450	2003 → 2003			FMD0184	MXR
MC	450	2007 → 2007			FMD0184	MXR

GILERA

DNA	50	2000 → 2007	FMD0053	R	FMD0022	R
DNA GP EXPERIENCE	50	2003 → 2004	FMD0053	R	FMD0022	R
EASY MOVING	50	1995 →	FMD0001	R		
GSM	50	1999 →	FMD0165	R	FMD0167	R
H@C	50	1999 →	FMD0165	R	FMD0167	R
NRG	50	1994 →	FMD0002	R		
RUNNER	50	1996 →	FMD0007	R		
RUNNER SP	50	1998 → 2006	FMD0007	R	FMD0210	R
RUNNER PURE JET	50	2002 → 2006	FMD0007	R	FMD0210	R
RUNNER SP RACE	50	2006 →	FMD0007	R	FMD0210	R
RUNNER SP SC	50	2006 → 2007	FMD0007	R	FMD0210	R
RUNNER PURE JET ST	50	2008 →	FMD0043	R	FMD0210	R
RUNNER SP ST	50	2008 →	FMD0043	R	FMD0210	R
RUNNER / BLACK SOUL	50	2009 → 2016	FMD0398	R		
RUNNER 2T	50	2014 → 2016	FMD0043	R		
RUNNER 2T SP	50	2017 → 2018	FMD0398	R		
RUNNER DD - SP	50	1997 → 2004	FMD0007	R	FMD0210	R
STALKER (post freno a disco)	50	1997 → 2004	FMD0002	R	FMD0210	R
STALKER (post freno a tamburo)	50	1997 → 2004	FMD0002	R		
STORM	50	1994 → 1995	FMD0002	R		
SURFER	50	1999 →	FMD0165	R		
TYPHOON	50	1994 → 1997	FMD0002	R		
TYPHOON X	50	1998 → 1999	FMD0002	R		
TYPHOON XR	50	2000 → 2000	FMD0002	R		
ZULU	50	2001 →	FMD0165	R	FMD0167	R
TYPHOON	80	1993 →	FMD0002	R		
DNA	125	2001 →	FMD0053	R	FMD0022	R
GFR	125	1993 → 1994	FMD0111	RX		
NEXUS EURO 3	125	2007 →	FMD0055	R		
NEXUS IE EURO 3	125	2008 → 2011	FMD0055	R		
RC TOP RALLY	125	1989 →	FMD0078	R		
RUNNER	125	1997 → 1999	FMD0007	R		
RUNNER FX - FXR	125	1997 → 2002	FMD0007	R	FMD0053	R
RUNNER SP	125	1999 →	FMD0007	R	FMD0053	R
RUNNER VX / VXR 4T	125	2001 → 2004	FMD0007	R	FMD0022	R
TYPHOON	125	1995 → 1998	FMD0002	R		
RUNNER	180	1997 → 1998	FMD0007	R		
RUNNER FXR	180	1998 →	FMD0007	R	FMD0053	R
RUNNER SP	180	1999 →	FMD0007	R	FMD0053	R
RUNNER VXR	180	2001 → 2004	FMD0007	R	FMD0022	R
RUNNER VX / VXR 4T	200	2002 →	FMD0007	R	FMD0022	R
RUNNER VXR 4T RACE	200	2006 →	FMD0007	R	FMD0022	R

GILERA



DISCS TYPE



DISCS TYPE

...HARLEY D.

FXDS DYNA SUPER GLIDE SPORT	1450	2000	→	FMD0266 (x2)	RF/R	FMD0267	RF/R
FXDX DYNA SUPER GLIDE T-SPORT	1450	2000	→ 2005	FMD0266 (x2)	RF/R	FMD0267	RF/R
FXD DYNA SUPER GLIDE	1450	2000	→ 2003	FMD0266	RF/R	FMD0267	RF/R
FXDL DYNA LOW RIDER	1450	2000	→ 2006	FMD0266 (x2)	RF/R	FMD0267	RF/R
FXDWG DYNA WIDE GLIDE	1450	2000	→ 2005	FMD0266	RF/R	FMD0267	RF/R
FXDB DYNA STREET BOB	1450	2006	→ 2007	FMD0430	R	FMD0267	RF/R
FXDWG DYNA WIDE GLIDE	1450	1993	→ 1999	FMD0085	RPF/RF/R	FMD0211	RPF/RF/R
FXDWG DYNA WIDE GLIDE	1450	2006	→ 2007	FMD0431	R	FMD0267	RF/R
FXD DYNA SUPER GLIDE	1450	2006	→ 2007	FMD0431	R	FMD0267	RF/R
FXDC DYNA SUPER GLIDE CUSTOM	1450	2006	→ 2007	FMD0431	R	FMD0267	RF/R
FLHT/I ELECTRA GLIDE STANDARD	1450	1998	→ 1999	FMD0085 (x2)	RPF/RF/R	FMD0211	RPF/RF/R
FLHT/I ELECTRA GLIDE STANDARD	1450	2000	→ 2006	FMD0266 (x2)	RF/R	FMD0267	RF/R
FLHTCUI ELECTRA GLIDE ULTRA CLASSIC	1450	2000	→ 2006	FMD0266 (x2)	RF/R	FMD0267	RF/R
FLSTF FAT BOY	1450	2000	→ 2006	FMD0266	RF/R	FMD0267	RF/R
FLSTC HERITAGE SOFTAIL CLASSIC	1450	2000	→ 2006	FMD0266	RF/R	FMD0267	RF/R
FLSTS HERITAGE SPRINGER	1450	2000	→ 2003	FMD0266	RF/R	FMD0267	RF/R
FXSTB/I NIGHT TRAIN	1450	2000	→ 2007	FMD0266	RF/R	FMD0267	RF/R
FLTR/I ROAD GLIDE	1450	1998	→ 1999	FMD0085 (x2)	RPF/RF/R	FMD0211	RPF/RF/R
FLTR/I ROAD GLIDE	1450	2000	→ 2007	FMD0266 (x2)	RF/R	FMD0267	RF/R
FLHR/I ROAD KING	1450	1998	→ 1999	FMD0085 (x2)	RPF/RF/R	FMD0211	RPF/RF/R
FLHR/I ROAD KING	1450	2000	→ 2007	FMD0266 (x2)	RF/R	FMD0267	RF/R
FLHRCI ROAD KING CLASSIC	1450	2000	→ 2006	FMD0266 (x2)	RF/R	FMD0267	RF/R
FXST SOFTAIL STANDARD	1450	2000	→ 2007	FMD0266	RF/R	FMD0267	RF/R
FXSTD/I SOFTAIL DEUCE	1450	2000	→ 2006	FMD0266	RF/R	FMD0267	RF/R
FXRS SPORT GLIDE	1450	1984	→ 1986	FMD0085	RPF/RF/R	FMD0211	RPF/RF/R
FXSTS/I SPRINGER SOFTAIL	1450	2000	→ 2006	FMD0266	RF/R	FMD0267	RF/R
FXS BLACKLINE	1584	2011	→ 2013	FMD0266	RF/R	FMD0267	RF/R
FXDB DYNA STREET BOB	1584	2008	→ 2014	FMD0430	R	FMD0267	RF/R
FXDB DYNA STREET BOB	1584	2006	→ 2010	FMD0431	R	FMD0267	RF/R
FXDL DYNA LOW RIDER	1584	2007	→ 2010	FMD0431	R	FMD0267	RF/R
FXD DYNA SUPER GLIDE	1584	2008	→ 2010	FMD0431	R	FMD0267	RF/R
FXDC DYNA SUPER GLIDE CUSTOM	1584	2008	→ 2014	FMD0431	R	FMD0267	RF/R
FXDWG DYNA WIDE GLIDE	1584	2008	→ 2014	FMD0431	R	FMD0267	RF/R
FLHT/I ELECTRA GLIDE STANDARD	1584	2007	→ 2007	FMD0266 (x2)	RF/R	FMD0267	RF/R
FLHTCU ELECTRA GLIDE ULTRA CLASSIC	1584	2007	→ 2008	FMD0266 (x2)	RF/R	FMD0267	RF/R
FLHT/I ELECTRA GLIDE STANDARD	1584	2008	→ 2010	FMD0430 (x2)	R	FMD0433	R
FLHTC ELECTRA GLIDE CLASSIC	1584	2008	→ 2013	FMD0430 (x2)	R	FMD0433	R
FLHTCU ELECTRA GLIDE ULTRA CLASSIC	1584	2009	→ 2013	FMD0430 (x2)	R	FMD0433	R
FXDF FAT BOB	1584	2008	→ 2014	FMD0431 (x2)	R	FMD0267	RF/R
FLSTF FAT BOY	1584	2007	→ 2014	FMD0266	RF/R	FMD0267	RF/R
FLSTB FAT BOY SPECIAL	1584	2010	→ 2013	FMD0266	RF/R	FMD0267	RF/R
FLSTC HERITAGE SOFTAIL CLASSIC	1584	2007	→ 2014	FMD0266	RF/R	FMD0267	RF/R
FXSTB NIGHT TRAIN	1584	2008	→ 2010	FMD0266	RF/R	FMD0267	RF/R
FLTR/I ROAD GLIDE	1584	2008	→ 2009	FMD0430 (x2)	R	FMD0433	R
FLHRC ROAD KING CLASSIC	1584	2007	→	FMD0266 (x2)	RF/R	FMD0267	RF/R
FLHR/I ROAD KING	1584	2008	→ 2010	FMD0430 (x2)	R	FMD0433	R
FLHRC ROAD KING CLASSIC	1584	2008	→ 2013	FMD0430 (x2)	R	FMD0433	R
FXCW ROCKER	1584	2008	→ 2009	FMD0266	RF/R	FMD0267	RF/R
FXCWC ROCKER C	1584	2008	→ 2013	FMD0266	RF/R	FMD0267	RF/R
FLSTN SOFTAIL DELUXE	1584	2005	→ 2014	FMD0266	RF/R	FMD0267	RF/R
FXSTC SOFTAIL CUSTOM	1584	2008	→ 2010	FMD0266	RF/R	FMD0267	RF/R
FLSTB SOFTAIL CROSS BONES	1584	2008	→ 2011	FMD0266	RF/R	FMD0267	RF/R
FLHX STREET GLIDE	1584	2006	→ 2007	FMD0266 (x2)	RF/R	FMD0267	RF/R
FLHX STREET GLIDE	1584	2008	→ 2013	FMD0430 (x2)	R	FMD0433	R
FLHTP ELECTRA GLIDE POLICE	1690	2009	→ 2011	FMD0430 (x2)	R	FMD0433	R
FLHTK ELECTRA GLIDE ULTRA LIMITED	1690	2010	→ 2013	FMD0430 (x2)	R	FMD0433	R
ELECTRA GLIDE ULTRA CLASSIC ABS	1690	2016	→			FMD0433	R
FLS SOFTAIL SLIM ABS	1690	2016	→ 2017	FMD0430	R	FMD0267	RF/R
FLSTC HERITAGE SOFTAIL CLASSIC ABS	1690	2016	→ 2017	FMD0430	R	FMD0267	RF/R
FLSTF FAT BOY	1690	2015	→ 2017	FMD0430	R	FMD0267	RF/R
FLSTF FAT BOY SPECIAL	1690	2015	→ 2017	FMD0430	R	FMD0267	RF/R
FLSTN SOFTAIL DELUXE ABS	1690	2015	→ 2017	FMD0430	R	FMD0267	RF/R
FLTRU	1690	2011	→	FMD0430 (x2)	R	FMD0433	R
FXDB DYNA STREET BOB ABS	1690	2014	→ 2017	FMD0430	R	FMD0267	RF/R
FXDF FAT BOB	1690	2012	→ 2017	FMD0430 (x2)	R	FMD0433	R
FXDL LOW RIDER ABS	1690	2015	→ 2017	FMD0431 (x2)	R	FMD0433	R
FXDWG DYNA WIDE GLIDE ABS	1690	2014	→ 2017	FMD0430	R	FMD0433	R
FXSB BREAKOUT	1690	2015	→ 2017	FMD0430	R	FMD0267	RF/R
FLTRX ROAD GLIDE CUSTOM	1690	2010	→ 2013	FMD0430 (x2)	R	FMD0433	R
FLTRUSE SCREAM EAGLE ROAD GLIDE	1690	2011	→	FMD0430 (x2)	R	FMD0433	R
ROAD GLIDE SPECIAL ABS	1690	2016	→			FMD0433	R
ROAD GLIDE ULTRA ABS	1690	2016	→			FMD0433	R
FLHP ROAD KING POLICE	1690	2010	→ 2011	FMD0430 (x2)	R	FMD0433	R
ROAD KING CLASSIC	1690	2014	→ 2015	FMD0430 (x2)	R	FMD0433	R
ROAD KING ABS	1690	2016	→			FMD0433	R
ROAD KING CLASSIC ABS	1690	2016	→	FMD0430 (x2)	R	FMD0433	R

HARLEY D.



DISCS TYPE



DISCS TYPE

...HARLEY D.

FLS SOFTAIL SLIM	1690	2012	→ 2014	FMD0266	RF/R	FMD0267	RF/R
FLHX STREET GLIDE	1690	2010	→ 2013	FMD0430 (x2)	R	FMD0433	R
STREET GLIDE SPECIAL ABS	1690	2016	→			FMD0433	R
FLD SWITCHBACK	1690	2012	→ 2014	FMD0431	R	FMD0267	RF/R
ULTRA LIMITED ABS	1690	2016	→			FMD0433	R
ULTRA LIMITED LOW ABS	1690	2016	→			FMD0433	R
FLHR ROAD KING ABS	1750	2017	→			FMD0433	R
FLHTK ULTRA LIMITED ABS	1750	2017	→			FMD0433	R
FLHTKL ULTRA LIMITED LOW ABS	1750	2017	→			FMD0433	R
FLHXS STREET GLIDE SPECIAL ABS	1750	2017	→			FMD0433	R
FLTRU ROAD GLIDE ULTRA ABS	1750	2017	→			FMD0433	R
FLTRXS ROAD GLIDE SPECIAL ABS	1750	2017	→			FMD0433	R
FLXRC ROAD KING ABS	1750	2017	→	FMD0430 (x2)	R	FMD0433	R
FLHTCUSE BLK ULTRA CLASSIC ELECTRA GLIDE	1800	2008	→ 2013	FMD0430 (x2)	R	FMD0433	R
FLHTCUSE CVO ULTRA CLASSIC ELECTRA GLIDE	1800	2009	→ 2013	FMD0430 (x2)	R	FMD0433	R
FLS SOFTAIL SLIM S	1800	2015	→ 2016	FMD0430	R	FMD0267	RF/R
FLSS SOFTAIL SLIM S ABS	1800	2016	→ 2017	FMD0430	R	FMD0267	RF/R
FLSTFBS FAT BOY S	1800	2016	→ 2017	FMD0430	R	FMD0267	RF/R
FXDLS LOW RIDER S ABS	1800	2016	→ 2017	FMD0431 (x2)	R	FMD0433	R
FLSTSE CVO SOFTAIL CONVERTIBLE	1800	2010	→ 2011	FMD0266	RF/R	FMD0267	RF/R
FXSTSS CVO SOFTAIL SPRINGER	1800	2009	→	FMD0266 (x2)	RF/R	FMD0267	RF/R
FLHXSE CVO STREET GLIDE	1800	2010	→ 2011	FMD0430 (x2)	R	FMD0433	R

HONDA

BALI	50	1993	→ 1997	FMD0002	R		
HM CRE DERAPAGE	50	2001	→ 2009	FMD0404	R		
HM CRE DERAPAGE RR	50	2007	→ 2009	FMD0404	R		
DIO SR	50	1990	→	FMD0006	R		
DIO GP	50	1991	→	FMD0006	R		
DIO ZX	50	1992	→	FMD0006	R		
HSC all models	50	1992	→	FMD0006	R		
LIFE DIO ZX	50	1994	→	FMD0006	R		
NSC AC / C / R / R REPSOL	50	2011	→ 2016	FMD0463	R		
NSC VISION CBS	50	2017	→ 2018	FMD0463	R		
NSR 50	50	1996	→ 2001	FMD0409	R	FMD0217	R
NSR 50 REPSOL	50	1996	→ 2001	FMD0409	R	FMD0217	R
SFX	50	1995	→	FMD0006	R		
SH 50 SCOOPY	50	1997	→ 2003	FMD0217	R		
SKY	50	1997	→	FMD0097	R		
SKY VETRO	50	2000	→	FMD0097	R		
SZX X 8RS	50	1998	→ 2004	FMD0435	R	FMD0436	R
SZX X 8RX	50	1998	→ 2004	FMD0435	R	FMD0436	R
VISION / VISION CBS	50	2011	→ 2018	FMD0463	R		
YUPI	50	1990	→	FMD0097	R		
NSR 75 (NS-1)	75	1994	→ 1998	FMD0409	R	FMD0217	R
CR R	80	1997	→ 2002	FMD0094	R	FMD0214	MXR
MTX R	80	1987	→	FMD0091	R		
CR	85	2003	→ 2007	FMD0094	R	FMD0214	MXR
YUPI	90	1992	→	FMD0002	R		
BALI SJ	100	1996	→	FMD0097	R		
SH 100 SCOOPY	100	1996	→ 2001	FMD0217	R		
NEW LEAD	107	2008	→	FMD0093	R		
BEAT CW / FI CW / SW	110	2012	→	FMD0463	R		
SCOOPY	110	2012	→	FMD0463	R		
SPACY HELM / VARIO CW	110	2012	→	FMD0463	R		
SPACY	110	2012	→	FMD0463	R		
VISION / CBS or NCS 16	110	2011	→ 2018	FMD0463	R		
WAVE 125 i	110	2011	→ 2017	FMD0463	R		
CBR R	125	2003	→ 2011	FMD0010	R	FMD0090	R
CBR R	125	2012	→ 2017			FMD0090	R
CH SPACY	125	1998	→	FMD0097 (x2)	R		
CR R	125	1985	→ 1988			FMD0185	R
CR R	125	1989	→ 1994	FMD0091	R	FMD0212	R
CR R - E	125	1995	→ 2001	FMD0095	MXR	FMD0212	R
CR SUPERMOTARD	125	2000	→			FMD0221	R
CR R - E	125	2002	→ 2007	FMD0095	MXR	FMD0197	MXR
DYLAN	125	2001	→ 2007	FMD0057	R		
FORZA ABS	125	2015	→ 2019	FMD0409	R	FMD0009	R
@ NES (tamburo post/rear drum)	125	2000	→ 2008	FMD0057	R		
@ NES	125	2009	→	FMD0425	R	FMD0009	R
NH LEAD	125	1988	→	FMD0006	R		
NSX - X-TREME	125	2013	→ 2017	FMD0463	R		
PANTHEON FES	125	1998	→ 2002	FMD0425	R		
PANTHEON FES	125	2003	→ 2007	FMD0425	R	FMD0014	R
PCX CBS	125	2010	→ 2017	FMD0463	R		

HARLEY D.

10012

FERODO

RACING

Updated on November 2020



DISCS TYPE



DISCS TYPE

...HONDA

PS i	125	2006 → 2013	FMD0057	R		
RS R GP	125	1991 → 2005	FMD0112	RX		
RS GP	125	1991 → 2005	FMD0112	RX		
RS R	125	1991 → 2005	FMD0112	RX		
S-WING FES	125	2008 →	FMD0425	R	FMD0014	R
SH i	125	2009 → 2019	FMD0425	R	FMD0009	R
SH/SH i (tamburo post/rear drum)	125	2000 → 2010	FMD0057	R		
SH Mode (tamburo post/rear drum)	125	2013 → 2019	FMD0463	R		
VARIO TECHNO / CBS	125	2012 →	FMD0463	R		
XLR	125	1993 →	FMD0091	R		
XLR R	125	1997 → 2003	FMD0091	R		
XLV VARADERO	125	2001 → 2011			FMD0090	R
CRF F	150	2003 → 2008	FMD0015	R		
CRF R	150	2007 → 2015	FMD0094	R		
CRF R	150	2007 → 2016			FMD0214	MXR
DYLAN SES	150	2001 → 2006	FMD0057	R		
@ NES (tamburo post/rear drum)	150	2000 → 2008	FMD0057	R		
@ NES	150	2009 →	FMD0425	R	FMD0009	R
PANTHEON FES	150	1998 → 2002	FMD0425	R		
PANTHEON FES	150	2003 → 2007	FMD0425	R	FMD0014	R
PCX / PCX CBS	150	2010 → 2017	FMD0463	R		
PS i	150	2006 → 2008	FMD0057	R		
S-WING FES	150	2007 →	FMD0425	R	FMD0014	R
SH/SH i (tamburo post/rear drum)	150	2000 → 2008	FMD0057	R		
SH i	150	2009 → 2019	FMD0425	R	FMD0009	R
SH i SPORTY	150	2009 → 2011	FMD0425	R	FMD0009	R
CRF F	230	2004 → 2008	FMD0015	R		
CRF	230	2004 → 2009	FMD0095	MXR		
CRF TRAIL	230	2004 → 2010	FMD0015	R		
SL	230	1997 → 2001	FMD0015	R	FMD0090	R
AX 1	250	1989 → 1994			FMD0212	R
CB TWO FIFTY	250	1993 → 2005	FMD0009	R		
CBR R	250	2011 → 2016			FMD0014	R
CBR R ABS	250	2014 → 2016			FMD0014	R
CBR RR ABS	250	2017 →			FMD0467	R
CH SPACY (spessore disco 4mm)	250	2000 →	FMD0271	R		
CN	250	1987 → 1998	FMD0271	R		
CR R	250	1989 → 1994	FMD0091	R	FMD0212	R
CR R - E	250	1995 → 1996	FMD0095	MXR	FMD0212	R
CR R - E	250	1997 → 2001	FMD0095	MXR	FMD0221	R
CR SUPERMOTARD	250	1998 → 2001			FMD0221	R
CR R - E	250	2002 → 2010	FMD0095	MXR	FMD0197	MXR
CRE IE	250	2007 → 2008	FMD0095	MXR	FMD0197	MXR
CRE- F - X	250	2007 →			FMD0197	MXR
CRF R- X	250	2004 → 2007			FMD0197	MXR
CRF R	250	2004 → 2014	FMD0095	MXR	FMD0197	MXR
CRF X	250	2004 →	FMD0095	MXR	FMD0197	MXR
CRF R EFI	250	2010 →			FMD0197	MXR
CRF L	250	2013 → 2014			FMD0090	R
CRF R	250	2015 →	FMD0460	MXR	FMD0197	MXR
CRF R- X SUPERMOTARD	250	2004 → 2007			FMD0197	MXR
CRM R	250	1991 → 1993	FMD0091	R	FMD0090	R
CRM R	250	1994 → 1996	FMD0091	R		
FORESIGHT	250	1997 → 1998	FMD0425	R		
FORESIGHT	250	1999 → 2007	FMD0425	R	FMD0014	R
FORZA NSS	250	2000 → 2004	FMD0425	R	FMD0014	R
FORZA X NSS	250	2005 → 2007	FMD0425	R	FMD0009	R
FORZA XE NSS	250	2005 → 2007	FMD0425	R	FMD0009	R
FORZA X NSS	250	2008 →	FMD0409	R	FMD0009	R
FORZA XE NSS	250	2008 →	FMD0409	R	FMD0009	R
CB F HORNET	250	1996 → 2001	FMD0112	RX	FMD0090	R
HORNET	250	1997 →	FMD0112	RX	FMD0014	R
JAZZ	250	2001 → 2004	FMD0425	R	FMD0014	R
RS R GP	250	1990 → 1997	FMD0112 (x2)	RX		
RS GP	250	1990 → 1997	FMD0112 (x2)	RX		
RS R	250	1990 → 1997	FMD0112 (x2)	RX		
TSR	250	1999 →	FMD0112 (x2)	RX		
VF V TWIN MAGNA	250	1997 → 1997	FMD0427	R		
VTR-F	250	2013 →			FMD0014	R
VTR	250	1998 →			FMD0014	R
VTZ XELVIS	250	1992 →	FMD0093	R		
XELVIS V-25	250	1997 →	FMD0093	R	FMD0014	R
XL R	250	1984 → 1992	FMD0091	R		
XLR R BAJA	250	1988 → 1990	FMD0015	R	FMD0011	R
XLR R BAJA	250	1991 →	FMD0015	R	FMD0011	R
XR R	250	1986 → 1988	FMD0091	R		

HONDA



DISCS TYPE



DISCS TYPE

...HONDA

XR R	250	1988 → 1990	FMD0015	R		
XR R	250	1991 → 2004	FMD0015	R	FMD0090	R
XR	250	2000 → 2003	FMD0015	R		
XR BAJA	250	2000 → 2003	FMD0015	R		
XR R, S	250	1994 →	FMD0015	R	FMD0090	R
CRE IE	290	2007 → 2008	FMD0095	MXR	FMD0197	MXR
CBR RR ABS	300	2017 → 2018			FMD0467	R
CRF X	300	2008 → 2012	FMD0095	MXR	FMD0197	MXR
FORZA ABS	300	2014 → 2018	FMD0409	R	FMD0009	R
FORZA DELUXE ABS	300	2019 →	FMD0409	R	FMD0009	R
FORZA REPSOL SE	300	2019 →	FMD0409	R	FMD0009	R
SH i	300	2006 → 2014	FMD0409	R	FMD0409	R
SH i ABS	300	2006 → 2014	FMD0409	R	FMD0409	R
SH 300 i ABS (NF05)	300	2015 → 2019	FMD0409	R	FMD0009	R
CB	350	1987 →	FMD0087 (x2)	R		
XL X	350	1989 →	FMD0091	R		
XL R	350	1985 →	FMD0091	R		
XR R	350	1983 → 1984	FMD0091	R		
CB 400 Super Four (NC31)	400	1992 → 1997			FMD0009	R
CB 400 Super Four (NC36)	400	1997 → 1998			FMD0009	R
CB	400	1989 → 1991			FMD0090	R
CB N	400	1982 → 1988	FMD0112 (x2)	RX	FMD0014	R
CBR F	400	1985 → 1987	FMD0112 (x2)	RX		
CBR R HURRICANE	400	1986 →			FMD0217	R
NSR R	400	1985 → 1988	FMD0409 (x2)	R	FMD0217	R
SILVER WING FJS	400	2006 → 2008	FMD0409	R	FMD0203	R
SW-T	400	2009 → 2014			FMD0203	R
SW-T ABS	400	2009 → 2014			FMD0203	R
VFR R	400	1985 → 1986	FMD0010 (x2)	R	FMD0217	R
VFR Z	400	1986 → 1987	FMD0010 (x2)	R		
VFR R	400	1987 → 1987	FMD0409 (x2)	R	FMD0217	R
VFR R	400	1988 → 1988	FMD0010 (x2)	R	FMD0217	R
VFR R	400	1989 → 1993	FMD0112 (x2)	RX		
XR R	400	1995 → 2005	FMD0015	R	FMD0090	R
XR SUPERMOTARD	400	2000 → 2007			FMD0090	R
XR R	400	2006 → 2007			FMD0090	R
XR R (DALLARA)	440	1999 →	FMD0015	R		
XR R	440	2006 → 2007			FMD0090	R
CB S	450	1985 → 1989	FMD0087 (x2)	R		
CRF R	450	2002 → 2014	FMD0095	MXR	FMD0197	MXR
CRF EFI	450	2009 → 2012	FMD0095	MXR	FMD0197	MXR
CRF R EFI	450	2013 → 2014	FMD0095	MXR	FMD0197	MXR
CRF R	450	2015 →	FMD0460	MXR	FMD0197	MXR
CRF RX	450	2017 →	FMD0460	MXR	FMD0197	MXR
CRF RX Enduro	450	2017 →	FMD0460	MXR	FMD0197	MXR
CRF 450 L	450	2019 →	FMD0460	MXR	FMD0197	MXR
CRF SUPERMOTARD	450	2002 → 2003			FMD0197	MXR
CRF X	450	2004 → 2007	FMD0095	MXR	FMD0197	MXR
CRM X SUPERMOTARD	450	2007 →			FMD0197	MXR
CB 500 F (PC45)	471	2012 → 2016			FMD0467	R
CB 500 X (PC46)	471	2012 → 2016			FMD0467	R
CB 500 X Travel Edition	471	2013 → 2016			FMD0467	R
CB 500 F (PC58)	471	2017 →			FMD0467	R
CB 500 X (PC59)	471	2017 →			FMD0467	R
CBR 500 R	471	2013 →			FMD0467	R
CB S	500	1998 → 2002			FMD0009	R
CB	500	1994 → 1996	FMD0093	R		
CB	500	1997 → 2003	FMD0093	R	FMD0009	R
CBF ABS	500	2004 → 2008	FMD0093	R	FMD0464	R
CR R	500	1987 → 1989			FMD0185	R
CR E	500	1988 → 1988	FMD0091	R		
CR R	500	1990 → 1994	FMD0091	R	FMD0212	R
CR R	500	1995 → 2001	FMD0095	MXR	FMD0212	R
CR R	500	2002 →	FMD0095	MXR	FMD0197	MXR
CRM X SUPERMOTARD	500	2007 →			FMD0197	MXR
CX	500	1982 → 1985	FMD0073 (x2)	R		
VF F	500	1984 → 1987	FMD0409 (x2)	R	FMD0409	R
XBR S	500	1985 → 1989	FMD0088	R		
XR R	500	1983 → 1986	FMD0090	R		
CBF	600	2003 → 2007	FMD0093 (x2)	R	FMD0464	R
CBF S ABS	600	2003 → 2007	FMD0093 (x2)	R	FMD0464	R
CBF N	600	2004 → 2007	FMD0093 (x2)	R	FMD0464	R
CBF N	600	2008 → 2011			FMD0464	R
CBR F SPORT	600	2001 → 2002	FMD0134 (x2)	RX	FMD0014	R
CBR RR	600	2003 → 2006	FMD0140 (x2)	RX	FMD0014	R
CBR RR	600	2007 → 2017	FMD0140 (x2)	RX	FMD0014	R

HONDA

10014

FERODO

RACING

Updated on November 2020



CC



DISCS TYPE



DISCS TYPE

...HONDA

CBR 600 FA	600	2011 → 2013			FMD0464	R
CBR F	600	1987 → 1990	FMD0010 (x2)	R	FMD0217	R
CBR F	600	1991 → 1994	FMD0010 (x2)	R	FMD0014	R
CBR F	600	1995 → 1998	FMD0112 (x2)	RX	FMD0014	R
CBR F	600	1999 → 2000	FMD0113 (x2)	RX	FMD0014	R
CBR F	600	2001 → 2007	FMD0134 (x2)	RX	FMD0014	R
CB F HORNET	600	1998 → 1999			FMD0014	R
CB F HORNET	600	2000 → 2006	FMD0137 (x2)	RX	FMD0014	R
CB F HORNET S	600	2000 → 2004	FMD0137 (x2)	RX	FMD0014	R
CB F HORNET	600	2007 → 2014			FMD0464	R
SILVER WING FSC	600	2001 → 2006	FMD0409	R	FMD0203	R
SILVER WING	600	2007 → 2007	FMD0010	R	FMD0203	R
SILVER WING ABS	600	2003 → 2007	FMD0010	R	FMD0203	R
SILVER WING ABS	600	2008 → 2008			FMD0203	R
SW-T	600	2009 → 2015			FMD0203	R
XL V TRANSALP	600	1997 → 1999	FMD0087 (x2)	R	FMD0009	R
XL R	600	1983 → 1987	FMD0015	R		
XL V TRANSALP (Rear Drum Model)	600	1987 → 1990	FMD0088	R		
XL V TRANSALP	600	1991 → 1996	FMD0088 (x2)	R	FMD0009	R
XR R	600	1985 → 1990	FMD0015	R		
XR R	600	1991 → 1999	FMD0015	R	FMD0090	R
XR L - R	600	1993 → 2000	FMD0015	R		
XR R	600	2000 → 2000			FMD0090	R
CB 650 F (RC75)	649	2014 →			FMD0467	R
CBR 650 F	649	2016 →			FMD0467	R
CBR 650 R	650	2019 →			FMD0467	R
FMX	650	2005 → 2008			FMD0011	R
FX VIGOR	650	1999 → 2003	FMD0010	R		
NT HAWK GT	650	1988 → 1990	FMD0427	R		
NTV REVERE	650	1988 → 1998	FMD0427	R		
NTV DEAUVILLE	650	1998 → 2005	FMD0093 (x2)	R	FMD0096	R
NX DOMINATOR 34 HP	650	1997 → 2002	FMD0087	R		
NX DOMINATOR	650	1993 → 2004	FMD0087	R	FMD0011	R
NX DOMINATOR	650	1988 → 1992	FMD0087	R	FMD0014	R
SLR	650	1996 → 1996	FMD0088	R		
SLR	650	1997 → 1998	FMD0088	R	FMD0011	R
SLR	650	1999 → 1999	FMD0088	R		
VIGOR	650	1999 → 2002	FMD0010	R	FMD0011	R
XL V TRANSALP	650	2000 → 2007	FMD0087 (x2)	R	FMD0009	R
XR L	650	1993 → 2012	FMD0087	R	FMD0014	R
XR R	650	2008 →	FMD0015	R		
XR R	650	2000 → 2007	FMD0015	R	FMD0216	R
XR V AFRICA TWIN	650	1988 → 1990	FMD0089	R	FMD0009	R
CTX 700 (RC69)	670	2013 → 2018			FMD0471	R
CTX 700 N (RC68)	670	2013 → 2017			FMD0471	R
NC 700 S (RC61)	670	2012 → 2014			FMD0471	R
NC 700 X (RC63)	670	2012 → 2014			FMD0471	R
NC 700 D Integra (RC62)	670	2012 → 2014			FMD0471	R
NTV DEAUVILLE	680	2006 → 2012	FMD0093 (x2)	R	FMD0096	R
XL V TRANSALP	700	2008 → 2011	FMD0087 (x2)	R	FMD0009	R
XL V TRANSALP ABS	700	2008 → 2011	FMD0087 (x2)	R	FMD0009	R
NC 750 S (RC70)	745	2013 → 2015			FMD0471	R
NC 750 X (RC72)	745	2013 → 2015			FMD0471	R
NC 750 D Integra (RC71)	745	2013 → 2015			FMD0471	R
NC 750 D Integra (RC89)	745	2015 → 2018			FMD0471	R
NC 750 X (RC90)	745	2016 →			FMD0471	R
X-ADV ABS	745	2017 →			FMD0464	R
X-ADV X-END ABS	745	2018 → 2018			FMD0464	R
X-ADV HARD TRACK ABS	745	2018 → 2018			FMD0464	R
X-ADV DESERT TRACK ABS	745	2019 →			FMD0464	R
X-ADV TRAVEL EDITION ABS	745	2019 →			FMD0464	R
CB F	750	1983 → 1984	FMD0093 (x2)	R		
CB N SEVEN FIFTY	750	1992 → 2002	FMD0093 (x2)	R	FMD0009	R
CBX F	750	1983 → 1988	FMD0010 (x2)	R	FMD0096	R
VF C MAGNA	750	1994 → 2003	FMD0427 (x2)	R		
VF SHADOW	750	1994 → 2007	FMD0427	R		
VFR F INTERCEPTOR	750	1986 → 1987	FMD0010 (x2)	R	FMD0409	R
VFR F	750	1990 → 1993	FMD0093 (x2)	R	FMD0220	R
VFR F	750	1994 → 1997	FMD0112 (x2)	RX	FMD0220	R
VFR F INTERCEPTOR	750	1988 → 1989	FMD0093 (x2)	R	FMD0409	R
VFR R	750	1988 → 1991	FMD0123 (x2)	RX		
VT C SHADOW	750	1986 → 2009	FMD0093	R		
VT BLACK WINDOW	750	2001 → 2004	FMD0093	R		
VT SHADOW (RC50)	750	2004 → 2008	FMD0093	R		
VT 750 Shadow Black Spirit	750	2010 → 2012	FMD0093	R		
VT C2 SHADOW A.C.E.	750	1997 → 2008	FMD0093	R		

HONDA



DISCS TYPE



DISCS TYPE

...HONDA

XLV R	750	1983	→ 1987	FMD0010	R		
XRV AFRICA TWIN	750	1990	→ 2002	FMD0033 (x2)	R	FMD0059	R
XRV R AFRICA TWIN	750	1990	→ 1993	FMD0033 (x2)	R	FMD0059	R
CROSSRUNNER	800	2011	→ 2014	FMD0113 (x2)	RX		
PACIFIC COAST	800	1989	→ 1992	FMD0096 (x2)	R		
VFR V-TEC	800	1998	→ 2001			FMD0220	R
VFR FI	800	1998	→ 1999			FMD0220	R
VFR V-TEC	800	2002	→ 2010	FMD0113 (x2)	RX	FMD0220	R
VFR V-TEC ABS	800	2002	→ 2013	FMD0113 (x2)	RX		
VFR V-TEC	800	2011	→ 2013	FMD0113 (x2)	RX		
CB F HORNET	900	2002	→ 2006	FMD0134 (x2)	RX	FMD0009	R
CB HORNET	900	2002	→ 2007			FMD0009	R
CBR F	900	2003	→	FMD0113 (x2)	RX		
CBR RR	900	1992	→ 1993	FMD0113 (x2)	RX	FMD0014	R
CBR RR	900	1994	→ 1997	FMD0112 (x2)	RX	FMD0014	R
CBR RR	900	1998	→ 1999	FMD0128 (x2)	RX	FMD0014	R
CBR RR	929	2000	→ 2001	FMD0130 (x2)	RX	FMD0014	R
CBR RR	954	2002	→ 2003	FMD0130 (x2)	RX	FMD0014	R
CRF 1000 L Africa Twin	998	2015	→			FMD0469	R
CRF 1000 L Africa Twin Travel Edition	998	2016	→			FMD0469	R
CRF 1000 L Africa Twin Adventure Sport	998	2018	→			FMD0469	R
CRF 1000 L Africa Twin Rally	998	2018	→ 2018			FMD0469	R
CB	1000	1993	→ 1993	FMD0123 (x2)	RX		
CB 1000 R	1000	2008	→ 2016	FMD0140 (x2)	RX		
CB 1000 R - ABS	1000	2009	→ 2017	FMD0140 (x2)	RX		
CB F Big one	1000	1993	→ 1995			FMD0096	R
CBF	1000	2006	→ 2011			FMD0464	R
CBF F	1000	2009	→ 2013			FMD0464	R
CBF ST	1000	2010	→ 2013			FMD0464	R
CBR F	1000	1987	→ 1992	FMD0093 (x2)	R	FMD0096	R
CBR F-FP	1000	1993	→ 1999	FMD0093 (x2)	R	FMD0409	R
CBR RR Fireblade	1000	2006	→ 2007	FMD0135 (x2)	RX	FMD0014	R
CBR RR Fireblade	1000	2008	→ 2015	FMD0411 (x2)	RX	FMD0014	R
CBR RR Fireblade ABS	1000	2009	→ 2016	FMD0411 (x2)	RX	FMD0014	R
CBR RR Fireblade ABS	1000	2017	→ 2019			FMD0014	R
CBR RR Fireblade	1000	2004	→ 2005	FMD0140 (x2)	RX	FMD0014	R
CBR RR Fireblade SP	1000	2014	→ 2016	FMD0411 (x2)	RX	FMD0014	R
CBR RR Fireblade SP	1000	2017	→ 2018			FMD0014	R
VF R	1000	1986	→ 1987	FMD0010 (x2)	R		
VF F	1000	1984	→ 1988	FMD0010 (x2)	R		
VTR F FIRESTORM	1000	1997	→ 2007	FMD0112 (x2)	RX	FMD0014	R
VTR F SUPER HAWK	1000	1997	→ 2007	FMD0112 (x2)	RX	FMD0014	R
VTR SP1 RC51	1000	2000	→ 2001	FMD0135 (x2)	RX	FMD0014	R
VTR SP2 RC51	1000	2002	→ 2004	FMD0135 (x2)	RX	FMD0014	R
XLV VARADERO	1000	2003	→ 2011	FMD0113 (x2)	RX	FMD0409	R
XLV VARADERO ABS	1000	2004	→ 2011	FMD0113 (x2)	RX	FMD0409	R
XLV VARADERO	1000	1999	→ 2002	FMD0113 (x2)	RX	FMD0059	R
CB X-11	1100	2000	→ 2003			FMD0409	R
CBR XX BLACKBIRD	1100	1997	→ 1998			FMD0409	R
CBR XX SUPERBLACKBIRD	1100	1999	→ 2008			FMD0409	R
GL GOLD WING	1100	1982	→ 1983	FMD0098 (x2)	R	FMD0098	R
ST PAN EUROPEAN	1100	1989	→ 1989	FMD0093 (x2)	R		
ST PAN EUROPEAN	1100	1990	→ 1995	FMD0093 (x2)	R	FMD0403	R
ST PAN EUROPEAN	1100	1996	→ 2001	FMD0427 (x2)	R		
ST PAN EUROPEAN ABS	1100	1992	→ 1995	FMD0093 (x2)	R	FMD0403	R
ST PAN EUROPEAN ABS	1100	1996	→ 2001	FMD0093 (x2)	R		
VT SHADOW ACE-AERO-C2-C3	1100	1995	→ 1998	FMD0427	R	FMD0096	R
VT SHADOW	1100	1992	→ 1995	FMD0427	R		
CB	1300	2001	→ 2002			FMD0096	R
CB	1300	2003	→ 2008	FMD0140 (x2)	RX		
CB F SUPER FOUR	1300	2003	→ 2004			FMD0409	R
CB SUPER BOL DOR	1300	2005	→ 2008			FMD0409	R
CB SUPERFOUR	1300	2005	→ 2009			FMD0409	R
CB	1300	1998	→ 2000			FMD0096	R
CB X4	1300	1997	→ 2000	FMD0128 (x2)	RX	FMD0096	R
CTX 1300 ABS	1300	2014	→ 2016	FMD0140 (x2)	RX		
VT 1300 CX	1300	2010	→ 2012			FMD0093	R
GL GOLDWING	1500	1990	→ 2000	FMD0098 (x2)	R	FMD0403	R
GL GOLDWING	1500	1988	→ 1989	FMD0098 (x2)	R		
GL F6C VALKYRIE	1500	1997	→ 2003	FMD0113 (x2)	RX		
GLX	1500	1988	→	FMD0098 (x2)	R		
GL GOLD WING	1800	2001	→ 2017	FMD0113 (x2)	RX		
GOLD WING F6B	1800	2013	→ 2017	FMD0113 (x2)	RX		

HONDA

10016

FERODO

RACING

Updated on November 2020



DISCS TYPE



DISCS TYPE

HRD

GS 97

250 1997 →

FMD0157

R

FMD0258

R

HUSABERG

TE	125	2012 → 2014				FMD0184	MXR
FE	250	2013 → 2014				FMD0184	MXR
TE	250	2011 → 2014				FMD0184	MXR
TE	300	2011 → 2014				FMD0184	MXR
FE	350	2013 → 2014				FMD0184	MXR
FE	390	2010 → 2010				FMD0184	MXR
FE	390	2011 → 2012	FMD0017	RF/MXR		FMD0184	MXR
FE	390	2013 →	FMD0017	RF/MXR			
FC	400	1999 → 2002	FMD0017	RF/MXR			
FE S - E	400	1998 → 1999	FMD0017	RF/MXR			
FE	400	2000 → 2003	FMD0017	RF/MXR		FMD0184	MXR
FE E	400	2001 → 2003	FMD0017	RF/MXR		FMD0184	MXR
FS C	400	2001 → 2003	FMD0017	RF/MXR		FMD0184	MXR
FS E	400	2001 → 2003	FMD0017	RF/MXR		FMD0184	MXR
FC	450	1998 → 2003	FMD0017	RF/MXR			
FE E	450	2004 →	FMD0017	RF/MXR			
FE	450	2009 → 2012	FMD0017	RF/MXR		FMD0184	MXR
FE	450	2013 → 2014				FMD0184	MXR
FS E - C	450	2003 → 2004				FMD0184	MXR
FS C	450	2003 → 2008				FMD0184	MXR
FS E	450	2003 → 2008				FMD0184	MXR
FS E - C	450	2005 → 2006				FMD0184	MXR
FX	450	2003 → 2009	FMD0017	RF/MXR			
FX	450	2010 →	FMD0017	RF/MXR		FMD0184	MXR
FC E	470	2001 → 2002	FMD0017	RF/MXR			
FX E	470	2001 → 2002	FMD0017	RF/MXR			
FC	501	1998 → 1998	FMD0017	RF/MXR			
FC	501	1999 → 2003	FMD0017	RF/MXR		FMD0184	MXR
FE S - E	501	1998 → 2004	FMD0017	RF/MXR			
FE E	501	1999 → 2004	FMD0017	RF/MXR		FMD0184	MXR
FE S	501	1999 → 2004	FMD0017	RF/MXR		FMD0184	MXR
FE	510	2013 → 2014				FMD0184	MXR
FC	550	2001 → 2005	FMD0017	RF/MXR		FMD0184	MXR
FC	550	2006 →	FMD0017	RF/MXR			
FE E	550	2004 → 2008	FMD0017	RF/MXR		FMD0184	MXR
FE	570	2009 → 2010	FMD0017	RF/MXR			
FE	570	2010 → 2012	FMD0017	RF/MXR		FMD0184	MXR
FS	570	2010 →				FMD0184	MXR
FC	600	1999 → 2003	FMD0017	RF/MXR		FMD0184	MXR
FE S	600	1999 → 2003	FMD0017	RF/MXR		FMD0184	MXR
FE E	600	1999 → 2002	FMD0017	RF/MXR		FMD0184	MXR
FE E	650	2001 → 2008	FMD0017	RF/MXR		FMD0184	MXR
FS E - C	650	2001 → 2004	FMD0017	RF/MXR		FMD0184	MXR
FS C	650	2001 → 2008				FMD0184	MXR
FS E	650	2001 → 2008				FMD0184	MXR
FS E - C	650	2005 → 2006				FMD0184	MXR
FX E	650	2001 → 2005	FMD0017	RF/MXR		FMD0184	MXR
FX E	650	2006 →	FMD0017	RF/MXR			

HUSQVARNA

WRS	50	1998 →	FMD0002	R			
CR	65	2010 → 2014	FMD0100	R			
TC 85 (17/14)	85	2014 → 2015	FMD0399	R/MXR			
CR	125	1991 → 1996	FMD0225	R		FMD0179	R
CR	125	1996 → 2003	FMD0018	R		FMD0190	R
CR	125	2004 → 2013	FMD0018	R		FMD0335	R
TC	125	2014 →	FMD0017	RF/MXR		FMD0184	MXR
TE 4T	125	2011 → 2013	FMD0017	RF/MXR			
TE	125	2014 → 2015	FMD0017	RF/MXR		FMD0184	MXR
WR	125	1991 → 1997				FMD0179	R
WR	125	1998 → 2003	FMD0018	R		FMD0190	R
WR	125	2004 → 2013	FMD0018	R		FMD0335	R
WRE	125	1995 → 2004	FMD0018	R		FMD0190	R
WRE DUAL	125	1995 → 2003	FMD0018	R		FMD0190	R
WRE	125	2005 → 2013	FMD0018	R			
CR	250	1996 → 2003	FMD0018	R		FMD0190	R
CR	250	2004 → 2013	FMD0018	R		FMD0335	R
FC	250	2014 → 2016	FMD0017	RF/MXR		FMD0184	MXR
FE	250	2014 → 2015	FMD0017	RF/MXR		FMD0184	MXR
TC	250	2002 → 2013	FMD0018	R		FMD0335	R
TC	250	2014 →	FMD0017	RF/MXR		FMD0184	MXR

HUSQVARNA



DISCS TYPE



DISCS TYPE

...HUSQVARNA

TE	250	2002 → 2003	FMD0018	R	FMD0190	R
TE	250	2004 → 2013	FMD0018	R		
TE	250	2014 → 2016	FMD0017	RF/MXR	FMD0184	MXR
TXC	250	2011 → 2014	FMD0018	R	FMD0335	R
WR	250	1991 → 1997	FMD0225	R	FMD0179	R
WR	250	1998 → 2003	FMD0018	R	FMD0190	R
WR	250	2004 → 2006	FMD0018	R		
WR	250	2007 → 2013	FMD0018	R		
TE	300	2014 → 2015	FMD0017	RF/MXR	FMD0184	MXR
TXC	310	2011 → 2014	FMD0018	R	FMD0335	R
FC	350	2014 → 2016	FMD0017	RF/MXR	FMD0184	MXR
FE	350	2014 → 2015	FMD0017	RF/MXR	FMD0184	MXR
TE	350	1990 → 1995			FMD0179	R
TE	350	1996 → 2013	FMD0225	R	FMD0179	R
WR	360	2000 → 2001	FMD0018	R	FMD0190	R
WR	360	2002 →	FMD0018	R		
401 Svartpilen	375	2017 →			FMD0472	R
401 Vitpilen	375	2017 →			FMD0472	R
TE	400	2002 → 2002	FMD0018	R		
TE	410	1995 → 2000	FMD0225	R	FMD0179	R
TE	410	2000 → 2001	FMD0018	R	FMD0190	R
TE	410	2002 → 2013	FMD0018	R		
SMR 449	449	2011 → 2012			FMD0335	R
TC	449	2011 → 2013	FMD0018	R		
FC	450	2014 → 2016	FMD0017	RF/MXR	FMD0184	MXR
FE	450	2014 → 2015	FMD0017	RF/MXR	FMD0184	MXR
TC	450	2002 → 2006	FMD0018	R		
TC	450	2007 → 2010	FMD0018	R	FMD0335	R
TE	450	2002 → 2005	FMD0018	R		
TE	450	2006 → 2010	FMD0018	R	FMD0335	R
TE	450	2011 → 2013	FMD0018	R		
TE	450	2014 →	FMD0017	RF/MXR		
TXC	450	2011 → 2013	FMD0018	R	FMD0335	R
FE	501	2014 → 2015	FMD0017	RF/MXR	FMD0184	MXR
FE	510	2014 →			FMD0184	MXR
SMR 510	510	2006 → 2010			FMD0335	R
TC	510	2002 → 2006	FMD0018	R		
TC	510	2007 → 2009	FMD0018	R	FMD0335	R
TE	510	2002 → 2005	FMD0018	R		
TE	510	2006 → 2010	FMD0018	R	FMD0335	R
TXC	510	2009 → 2010	FMD0018	R	FMD0335	R
SMR 511	511	2011 → 2012			FMD0335	R
TE	511	2011 → 2013	FMD0018	R	FMD0335	R
TXC	511	2011 → 2013	FMD0018	R	FMD0335	R
TC	570	2001 → 2002	FMD0018	R		
TC	570	2003 → 2013	FMD0018	R		
TE	570	2001 → 2002	FMD0018	R		
TE	570	2003 → 2013	FMD0018	R		
TC	610	1991 → 1997			FMD0179	R
TE	610	1991 → 1997	FMD0225	R	FMD0179	R
TE E	610	2000 → 2003	FMD0018	R	FMD0190	R
TE E	610	2004 → 2013	FMD0018	R		
TR 650 STRADA	650	2013 → 2014			FMD0207	R
TR 650 TERRA	650	2013 → 2014			FMD0207	R
NUDA	900	2012 → 2013	FMD0083 (x2)	R	FMD0407	R
NUDA R	900	2012 → 2013	FMD0083 (x2)	R	FMD0407	R
NUDA R ABS	900	2013 →	FMD0083 (x2)	R	FMD0407	R

INDIAN

CHIEF CLASSIC ABS	1811	2015 → 2016	FMD0121 (x2)	RX		
CHIEF DARK HORSE ABS	1811	2015 → 2016	FMD0121 (x2)	RX		
CHIEF VINTAGE ABS	1811	2015 → 2016	FMD0121 (x2)	RX		
CHIEFTAIN ABS	1811	2015 → 2016	FMD0121 (x2)	RX		
ROADMASTER ABS	1811	2015 → 2016	FMD0113 (x2)	RX		

ITALJET

BAZOOKA 2	50	1992 →	FMD0001	R		
DRAGSTER	50	1997 →	FMD0019	R		
FORMULA	50	1994 → 1996	FMD0019	R		
FORMULA	50	1997 →	FMD0019	R		
PISTA	50	1992 →	FMD0001	R		
SCOOP	50	1993 →	FMD0001	R		
YANKEE 8	50	1994 →	FMD0001	R		
DRAGSTER	125	1997 → 1998	FMD0019	R		

10018**FERODO**

RACING

Updated on November 2020



DISC TYPE



DISC TYPE

...ITALJET

DRAGSTER	125	1999 → 2001	FMD0019	R	FMD0053	R
FORMULA	125	1994 → 1996	FMD0019	R		
FORMULA	125	1997 →	FMD0019	R		
JUPITER	125	2002 →			FMD0173	R
JUPITER	150	2002 →			FMD0173	R
DRAGSTER	180	1997 → 1998	FMD0019	R		
DRAGSTER	180	1999 → 2001	FMD0019	R	FMD0053	R
JUPITER	250	2000 → 2003	FMD0023	R	FMD0173	R

KAWASAKI

KX	80	1993 → 2000	FMD0106	R	FMD0251	R
KX	85	2001 → 2015	FMD0106	R	FMD0251	R
KX	100	2001 → 2014	FMD0106	R	FMD0251	R
J125 ABS	125	2016 → 2019			FMD0244	R
KMX	125	1988 → 1995			FMD0234	R
KX	125	2003 → 2005			FMD0239	MXR
KX	125	2006 → 2008	FMD0456	MXR	FMD0239	MXR
EL	250	1990 →	FMD0104	R		
EX R NINJA	250	1986 → 1987	FMD0104 (x2)	R		
KX	250	2003 → 2006			FMD0239	MXR
KX F	250	2004 → 2005			FMD0239	MXR
KX	250	2006 → 2008	FMD0456	MXR	FMD0239	MXR
KX F	250	2006 → 2014	FMD0456	MXR	FMD0239	MXR
KX F	250	2015 →	FMD0461	MXR	FMD0239	MXR
ZZR	250	1992 →	FMD0115	RX		
J300	300	2014 → 2015	FMD0439	RF	FMD0244	R
J300 ABS	300	2014 → 2017	FMD0439	RF	FMD0244	R
J300 ABS SPECIAL EDITION	300	2014 → 2017	FMD0439	RF	FMD0244	R
J300 SPECIAL EDITION	300	2014 → 2015	FMD0439	RF	FMD0244	R
ELIMINATOR	400	1988 → 1989	FMD0218 (x2)	R		
ZX	400	1988 → 1989	FMD0101 (x2)	R		
ZXR	400	1989 → 1990	FMD0115 (x2)	RX	FMD0233	R
ZXR R	400	1991 → 1994			FMD0233	R
ZXR (ZX 400L) RR	400	1992 → 2002			FMD0233	R
ZXR	400	1991 → 2002	FMD0114 (x2)	RX	FMD0233	R
KLX R	450	2008 → 2015			FMD0239	MXR
KX F	450	2006 → 2014	FMD0456	MXR	FMD0239	MXR
KX F	450	2015 →	FMD0461	MXR		
KX F	450	2015 → 2018			FMD0239	MXR
EN VULCAN	500	1990 → 1993	FMD0020	R		
ER5	500	1996 → 2006	FMD0218	R		
GPZ S	500	1987 → 1988	FMD0218	R		
GPZ S	500	1989 → 2006	FMD0101 (x2)	R		
KLE	500	1991 → 2007	FMD0105	R	FMD0234	R
ZEPHYR	550	1993 → 2001	FMD0115 (x2)	RX	FMD0233	R
KLR	570	1984 → 1991	FMD0103	R		
ELIMINATOR	600	1986 → 1994	FMD0218	R		
ELIMINATOR	600	1995 → 1999	FMD0115	RX		
GPZ R	600	1984 → 1990	FMD0101 (x2)	R		
KLR	600	1984 → 1986	FMD0103	R		
KLR S	600	1990 → 1992	FMD0103	R		
KLR ELECTRIC STARTER	600	1985 → 1994	FMD0103	R		
ZX	600	1988 → 1990	FMD0101 (x2)	R		
ZX6RR NINJA	600	2005 → 2006	FMD0350 (x2)	RX	FMD0237	R
ZX6R NINJA	600	2007 → 2016	FMD0350 (x2)	RX	FMD0237	R
ZX6R NINJA	600	1995 → 1997	FMD0115 (x2)	RX		
ZX6R NINJA	600	1998 → 2001	FMD0115 (x2)	RX	FMD0237	R
ZX6RR NINJA	600	2003 → 2004			FMD0237	R
ZZR (ZX E6F)	600	2006 → 2007			FMD0233	R
ZZR	600	1990 → 1992	FMD0115 (x2)	RX		
ZZR	600	1993 → 2005	FMD0115 (x2)	RX	FMD0233	R
ZZR	600	2006 → 2006	FMD0115 (x2)	RX		
ZX6R NINJA	636	2002 → 2002	FMD0115 (x2)	RX	FMD0237	R
ZX6R NINJA	636	2005 → 2006	FMD0350 (x2)	RX	FMD0237	R
ZX6R NINJA	636	2013 → 2015	FMD0410 (x2)	RX		
ZX6R NINJA ABS	636	2013 → 2016	FMD0410 (x2)	RX		
ZX6R NINJA	636	2003 → 2004			FMD0237	R
ER6F (No ABS)	650	2006 → 2015	FMD0350 (x2)	RX	FMD0237	R
ER6N NO ABS	650	2006 → 2015	FMD0350	RX	FMD0237	R
KL TENGAI	650	1989 → 1992	FMD0328	R	FMD0234	R
KLR	650	1987 → 1994			FMD0234	R
KLR A	650	1987 → 1989			FMD0234	R
KLR	650	1995 → 2004	FMD0328	R	FMD0234	R
KLR	650	2005 → 2007			FMD0234	R
KLR B1-B3 Tengai	650	1989 → 1991			FMD0234	R

KAWASAKI



DISCS TYPE



DISCS TYPE

...KAWASAKI

VERSYS (NO ABS)	650	2007 → 2014	FMD0350 (x2)	RX	FMD0237	R
GPX	750	1987 → 1989	FMD0076 (x2)	R	FMD0233	R
GPX R	750	1986 → 1987			FMD0233	R
GPZ TURBO	750	1983 → 1985			FMD0104	R
GPZ UNITRAK	750	1983 → 1984	FMD0101 (x2)	R	FMD0104	R
GPZ UNITRAK	750	1985 → 1988	FMD0101 (x2)	R		
GPZ R	750	1985 → 1987	FMD0101 (x2)	R		
Z 750TURBO	750	1984 → 1986	FMD0218 (x2)	R	FMD0101	R
Z 750	750	2004 → 2006	FMD0115 (x2)	RX	FMD0237	R
Z 750 S	750	2005 → 2006	FMD0115 (x2)	RX	FMD0237	R
Z 750	750	2007 → 2012	FMD0350 (x2)	RX	FMD0466	R
Z 750 R	750	2011 → 2012	FMD0350	RX		
Z 750 R	750	2011 → 2014			FMD0466	R
Z 750 R - ABS	750	2011 → 2014			FMD0466	R
ZEPHYR	750	1991 → 1999	FMD0115 (x2)	RX		
ZR7	750	1999 → 2003	FMD0115 (x2)	RX	FMD0233	R
ZR7S	750	2001 → 2003	FMD0115 (x2)	RX	FMD0233	R
ZX7R NINJA	750	1989 → 1995	FMD0114 (x2)	RX	FMD0199	R
ZXR	750	1989 → 1995	FMD0114 (x2)	RX	FMD0199	R
ZXR L	750	1993 → 1995	FMD0116 (x2)	RX	FMD0199	R
ZXR R	750	1993 → 1995	FMD0116 (x2)	RX	FMD0199	R
ZX7R NINJA	750	1996 → 2003	FMD0116 (x2)	RX	FMD0199	R
ZX7RR NINJA	750	1996 → 2002	FMD0116 (x2)	RX	FMD0199	R
ZX7RR NINJA	750	2003 →	FMD0116 (x2)	RX		
ZXR R	750	1989 → 1992	FMD0114 (x2)	RX	FMD0199	R
Z 800	800	2013 → 2015	FMD0410 (x2)	RX		
Z 800	800	2013 → 2017			FMD0466	R
Z 800 ABS	800	2013 → 2016	FMD0410 (x2)	RX		
Z 800 ABS	800	2013 → 2017			FMD0466	R
Z 800e	800	2013 → 2015	FMD0410 (x2)	RX		
Z 800e	800	2013 → 2017			FMD0466	R
Z 800e ABS	800	2013 → 2016	FMD0410 (x2)	RX		
Z 800e ABS	800	2013 → 2017			FMD0466	R
Z 800 Sugomi Ed.	800	2016 → 2016			FMD0466	R
ELIMINATOR	900	1985 → 1987	FMD0218 (x2)	R	FMD0101	R
GPZ NINJA	900	1984 → 1986	FMD0218 (x2)	R	FMD0101	R
GPZ R	900	1990 → 2003	FMD0115 (x2)	RX		
GPZ R	900	1984 → 1989	FMD0218 (x2)	R	FMD0101	R
ZX-9 R NINJA	900	1994 → 1997			FMD0199	R
ZX-9 R NINJA	900	1998 → 1999	FMD0224 (x2)	RX		
ZX9R NINJA	900	1994 → 1997	FMD0116 (x2)	RX	FMD0199	R
ZX9R NINJA	900	1998 → 1999			FMD0237	R
ZX9R NINJA	900	2000 → 2001	FMD0114 (x2)	RX	FMD0237	R
ZX9R NINJA	900	2002 → 2003	FMD0116 (x2)	RX	FMD0237	R
Z 900 (ZR900D)	948	2016 → 2017			FMD0466	R
ELIMINATOR	1000	1986 → 1990	FMD0218 (x2)	R	FMD0101	R
GPX R	1000	1986 → 1989	FMD0218 (x2)	R		
GTR	1000	1994 → 2006	FMD0115 (x2)	RX	FMD0218	R
GTR	1000	1986 → 1993	FMD0101 (x2)	R	FMD0199	R
VERSYS	1000	2012 → 2014	FMD0350 (x2)	RX		
VERSYS	1000	2012 → 2015			FMD0466	R
VERSYS ABS	1000	2015 → 2017	FMD0410 (x2)	RX		
VERSYS ABS	1000	2015 → 2019			FMD0466	R
VERSYS GRAND TOURER ABS	1000	2016 → 2018			FMD0466	R
VERSYS TOURER PLUS ABS	1000	2016 → 2018			FMD0466	R
Z 1000	1000	1981 → 1983			FMD0020	R
Z 1000	1000	2007 → 2013	FMD0350 (x2)	RX		
Z 1000	1000	2007 → 2014			FMD0466	R
Z 1000 - ABS	1000	2007 → 2014			FMD0466	R
Z 1000 SX	1000	2011 → 2016	FMD0350 (x2)	RX	FMD0466	R
Z 1000 SX ABS	1000	2011 → 2019			FMD0466	R
Z 1000 - ABS	1000	2014 → 2017	FMD0410 (x2)	RX		
Z 1000	1000	2014 → 2015	FMD0410	RX		
Z 1000 - ABS	1000	2015 → 2019			FMD0466	R
Z 1000	1000	2015 → 2017			FMD0466	R
Z1000 Sugomi Ed.	1000	2015 → 2016			FMD0466	R
Z 1000 SX	1000	2017 → 2019			FMD0466	R
Z 1000 SX TOURER	1000	2017 →			FMD0466	R
Z 1000	1000	2003 → 2006	FMD0115 (x2)	RX	FMD0237	R
Z 1000 R EDITION ABS (Brembo caliper)	1000	2017 → 2018	FMD0410 (x2)	RX		
Z 1000 R EDITION ABS (Brembo caliper)	1000	2017 → 2019			FMD0466	R
ZL	1000	1986 → 1988	FMD0218 (x2)	R	FMD0101	R
ZX-10R	1000	2004 → 2007	FMD0350 (x2)	RX	FMD0237	R
ZX-10R	1000	2008 → 2010	FMD0410 (x2)	RX	FMD0237	R
ZX-10R	1000	2011 → 2015	FMD0410 (x2)	RX		
ZX-10R ABS	1000	2011 → 2015	FMD0410 (x2)	RX		

KAWASAKI

10020

FERODO

RACING

Updated on November 2020



DISCS TYPE



DISCS TYPE

...KAWASAKI

GPZ	1100	1995 → 1998	FMD0115 (x2)	RX		
ZEPHYR	1100	1993 → 1995	FMD0114 (x2)	RX		
ZEPHYR	1100	1996 → 1998	FMD0114 (x2)	RX	FMD0199	R
ZR ZEPHYR	1100	1996 → 1997			FMD0199	R
ZRX	1100	1997 → 2000	FMD0114 (x2)	RX		
ZZR	1100	1990 → 1992	FMD0114 (x2)	RX		
ZZR	1100	1993 → 1999	FMD0116 (x2)	RX		
ZRX	1200	2001 → 2006	FMD0114 (x2)	RX		
ZRX S	1200	2001 → 2006	FMD0114 (x2)	RX		
ZRX R	1200	2001 → 2006	FMD0114 (x2)	RX		
ZX12R NINJA	1200	2004 → 2006	FMD0115 (x2)	RX	FMD0238	R
ZX12R NINJA	1200	2000 → 2003	FMD0116 (x2)	RX	FMD0238	R
ZZR	1200	2002 → 2005	FMD0116 (x2)	RX		
GTR	1400	2007 → 2015	FMD0410 (x2)	RX		
GTR ABS	1400	2008 → 2016	FMD0410 (x2)	RX		
ZZR ABS Performance Sport	1400	2016 → 2018	FMD0410 (x2)	RX	FMD0466	R
ZZR	1400	2006 → 2007	FMD0410 (x2)	RX		
ZZR	1400	2006 → 2016			FMD0466	R
ZZR ABS	1400	2006 → 2018	FMD0410 (x2)	RX	FMD0466	R
VN MEAN STREAK	1500	2002 → 2003	FMD0116 (x2)	RX		
VN MEAN STREAK	1600	2004 → 2007	FMD0116 (x2)	RX		

KEEWAY

FACT EVO 2T/4T	50	2015 →	FMD0002	R		
RY6 50	50	2017 →	FMD0097	R		
URBAN BLADE 4T	50	2018 →	FMD0097	R		
X-BLADE	50	2017 →	FMD0097	R		
ZAHARA 4T	50	2015 →	FMD0002	R		
Efi - RE-EVOLUTION	125	2008 → 2012	FMD0425	R	FMD0425	R
LOGIK / OUTLOOK	125	2008 → 2012	FMD0425	R	FMD0425	R
LOGIK i 4T Efi CBS	125	2013 →	FMD0425	R		
ZAHARA	125	2015 →	FMD0002	R		
OUTLOOK	150	2007 → 2008	FMD0425	R	FMD0425	R

KREIDLER

FLORETT 2.1 RS / CITY	50	2014 → 2015	FMD0002	R		
-----------------------	----	-------------	---------	---	--	--

KSR MOTO BY GENERIC

Epico electric		2012 → 2013	FMD0097	R		
CRACKER 2T / 4T	50	2009 → 2015	FMD0097	R		
Epico 50	50	2012 → 2017	FMD0097	R		
IDEO / XOR	50	2005 →	FMD0002	R		
IDEO / XOR 2T	50	2005 → 2014	FMD0097	R		
Race 2 50 (2T/4T)	50	2010 → 2014	FMD0097	R		
ROC	50	2008 →	FMD0002	R		
ROC / SIRION 2T / 4T	50	2008 → 2011	FMD0097	R		
TRIGGER	50	2002 →	FMD0097	R		
Vertigo 50 4T	50	2012 → 2014	FMD0097	R		
XOR 2	50	2010 →	FMD0002	R		
IDEO / XOR	125	2005 →	FMD0002	R		
Rumbler	125	2013 → 2016			FMD0014	R
SIRION 4T	125	2002 → 2014	FMD0097	R		
XOR	125	2005 → 2011	FMD0097	R		

KTM

KROSS	50	1996 →	FMD0002	R		
SX	65	1998 → 2018	FMD0100	R	FMD0228	R
SXS	65	2012 → 2013	FMD0100	R	FMD0228	R
XC	65	2008 → 2009	FMD0100	R	FMD0228	R
MX	80	2000 → 2002	FMD0100	R	FMD0228	R
SX	85	2003 → 2010	FMD0399	R/MXR	FMD0400	R
SX	85	2011 → 2015	FMD0399	R/MXR		
XC	85	2008 → 2009	FMD0399	R/MXR	FMD0400	R
SX	105	2004 → 2006			FMD0400	R
SX	105	2007 → 2008	FMD0399	R/MXR	FMD0400	R
SX	105	2009 →			FMD0400	R
XC	105	2008 → 2009	FMD0399	R/MXR	FMD0400	R
125 Duke	125	2011 → 2012			FMD0472	R
125 Duke ABS	125	2013 → 2016			FMD0472	R
125 Duke ABS	125	2017 →			FMD0472	R
EXC	125	1990 → 1993	FMD0017	RF/MXR		



DISCS TYPE



DISCS TYPE

...KTM

EXC/EGS	125	1994	→ 1997	FMD0017	RF/MXR		
EXC	125	1998	→ 2014	FMD0017	RF/MXR	FMD0184	MXR
EXC SIX DAYS	125	2004	→ 2008	FMD0017	RF/MXR		
EXC SIX DAYS	125	2009	→ 2014	FMD0017	RF/MXR	FMD0184	MXR
EXC	125	2015	→	FMD0017	RF/MXR	FMD0184	MXR
EXC SIX DAYS	125	2015	→	FMD0017	RF/MXR	FMD0184	MXR
EXE	125	2000	→ 2011	FMD0017	RF/MXR		
GS	125	1988	→ 1992			FMD0184	MXR
GS	125	1993	→ 1997	FMD0017	RF/MXR	FMD0184	MXR
MX	125	1988	→ 1991			FMD0184	MXR
MX	125	1992	→ 2000	FMD0017	RF/MXR	FMD0184	MXR
125 RC	125	2014	→			FMD0472	R
STING	125	1998	→			FMD0184	MXR
SX	125	1993	→ 2014	FMD0017	RF/MXR	FMD0184	MXR
SX	125	2015	→	FMD0017	RF/MXR	FMD0184	MXR
SXS	125	2000	→ 2010	FMD0017	RF/MXR	FMD0184	MXR
SX	144	2007	→ 2010	FMD0017	RF/MXR	FMD0184	MXR
SX	150	2008	→ 2014	FMD0017	RF/MXR	FMD0184	MXR
SX	150	2015	→	FMD0017	RF/MXR	FMD0184	MXR
XC	150	2010	→ 2016	FMD0017	RF/MXR	FMD0184	MXR
200 Duke ABS	200	2012	→			FMD0472	R
EGS	200	1998	→ 1999	FMD0017	RF/MXR		
EXC	200	1998	→ 2014	FMD0017	RF/MXR	FMD0184	MXR
EXC	200	2015	→	FMD0017	RF/MXR	FMD0184	MXR
MXC	200	1998	→ 2003			FMD0184	MXR
200 RC	200	2014	→			FMD0472	R
SX	200	2008	→			FMD0184	MXR
SX	200	2003	→ 2007	FMD0017	RF/MXR	FMD0184	MXR
XC W	200	2008	→ 2016	FMD0017	RF/MXR	FMD0184	MXR
250 Duke	249	2015	→			FMD0472	R
250 RC	249	2015	→			FMD0472	R
EGS	250	1994	→ 1999	FMD0017	RF/MXR		
EXC	250	1994	→ 1997	FMD0017	RF/MXR		
EXC	250	1998	→ 2014	FMD0017	RF/MXR	FMD0184	MXR
EXC RACING (4T)	250	2000	→ 2006	FMD0017	RF/MXR		
EXC F	250	2003	→ 2006			FMD0184	MXR
EXC G	250	2004	→ 2009			FMD0184	MXR
EXC SIX DAYS	250	2004	→ 2008	FMD0017	RF/MXR		
EXC F	250	2007	→ 2014	FMD0017	RF/MXR	FMD0184	MXR
EXC F SIX DAYS	250	2007	→ 2008	FMD0017	RF/MXR		
EXC F SIX DAYS	250	2009	→ 2014	FMD0017	RF/MXR	FMD0184	MXR
EXC SIX DAYS	250	2009	→ 2014	FMD0017	RF/MXR	FMD0184	MXR
EXC	250	2015	→	FMD0017	RF/MXR	FMD0184	MXR
EXC F	250	2015	→	FMD0017	RF/MXR	FMD0184	MXR
EXC F SIX DAYS	250	2015	→			FMD0184	MXR
EXC SIX DAYS	250	2015	→			FMD0184	MXR
GS	250	1988	→ 1992			FMD0184	MXR
GS	250	1993	→ 1997	FMD0017	RF/MXR	FMD0184	MXR
GS	250	1998	→ 2000	FMD0017	RF/MXR		
MX	250	1988	→ 1991			FMD0184	MXR
MX	250	1992	→ 2013	FMD0017	RF/MXR	FMD0184	MXR
MXC	250	1998	→ 2003			FMD0184	MXR
SX	250	1993	→ 2014	FMD0017	RF/MXR	FMD0184	MXR
SX F	250	2001	→ 2004	FMD0017	RF/MXR	FMD0184	MXR
SX F	250	2005	→ 2014	FMD0017	RF/MXR	FMD0184	MXR
SX	250	2015	→	FMD0017	RF/MXR	FMD0184	MXR
SX F	250	2015	→	FMD0017	RF/MXR	FMD0184	MXR
SXS	250	2001	→ 2002	FMD0017	RF/MXR		
SXS	250	2003	→ 2003	FMD0017	RF/MXR	FMD0184	MXR
SXS	250	2004	→ 2010			FMD0184	MXR
SXS F	250	2006	→ 2009			FMD0184	MXR
XC (2T)	250	1994	→ 2015	FMD0017	RF/MXR		
XC W	250	2006	→ 2010	FMD0017	RF/MXR	FMD0184	MXR
XC	250	2008	→ 2016	FMD0017	RF/MXR	FMD0184	MXR
XC W	250	2011	→ 2012	FMD0017	RF/MXR	FMD0184	MXR
XC W	250	2013	→	FMD0017	RF/MXR	FMD0184	MXR
XCF W	250	2012	→ 2013	FMD0017	RF/MXR	FMD0184	MXR
XCF W	250	2014	→	FMD0017	RF/MXR	FMD0184	MXR
EXC EGS	300	1993	→ 1999	FMD0017	RF/MXR		
EXC	300	1994	→ 1996	FMD0017	RF/MXR		
EXC	300	1997	→ 2013	FMD0017	RF/MXR	FMD0184	MXR
EXC	300	1997	→ 2002	FMD0017	RF/MXR	FMD0184	MXR
EXC SIX DAYS (2T)	300	2006	→ 2008	FMD0017	RF/MXR		
EXC SIX DAYS (2T)	300	2009	→ 2013	FMD0017	RF/MXR	FMD0184	MXR
EXC	300	2014	→			FMD0184	MXR
EXC SIX DAYS (2T)	300	2014	→ 2015			FMD0184	MXR

KTM

10022



DISCS TYPE



DISCS TYPE

...KTM

GS	300	1991 → 1996	FMD0017	RF/MXR	FMD0184	MXR
GS	300	1997 → 2000	FMD0017	RF/MXR		
MX	300	1991 → 1992			FMD0184	MXR
MXC	300	1998 → 2005			FMD0184	MXR
SX	300	1993 → 2000	FMD0017	RF/MXR	FMD0184	MXR
SX	300	1997 → 2002	FMD0017	RF/MXR	FMD0184	MXR
SX	300	2001 → 2003			FMD0184	MXR
XC (2T)	300	2006 → 2010			FMD0184	MXR
XC W	300	2006 → 2012			FMD0184	MXR
XC (2T)	300	2011 → 2012	FMD0017	RF/MXR	FMD0184	MXR
EXC F	350	2010 → 2011			FMD0184	MXR
EXC F SIX DAYS	350	2011 → 2011			FMD0184	MXR
EXC F	350	2012 → 2014	FMD0017	RF/MXR	FMD0184	MXR
EXC F SIX DAYS	350	2012 → 2013	FMD0017	RF/MXR	FMD0184	MXR
EXC F SIX DAYS	350	2014 →			FMD0184	MXR
EXC F	350	2015 →	FMD0017	RF/MXR	FMD0184	MXR
GS	350	1993 → 2000	FMD0017	RF/MXR	FMD0184	MXR
SX-F	350	2011 → 2017	FMD0017	RF/MXR	FMD0184	MXR
XC-F	350	2011 → 2012	FMD0017	RF/MXR		
XCF-W	350	2011 → 2013	FMD0017	RF/MXR		
EXC	360	1996 → 1997	FMD0017	RF/MXR		
SX	360	1996 → 1997	FMD0017	RF/MXR		
390 RC	373	2014 →			FMD0472	R
390 Duke ABS	375	2013 →			FMD0472	R
EXC	380	1998 → 2002	FMD0017	RF/MXR	FMD0184	MXR
MXC	380	1998 → 2001	FMD0017	RF/MXR	FMD0184	MXR
MXC	380	2002 → 2002	FMD0017	RF/MXR		
SX	380	1998 → 2002	FMD0017	RF/MXR	FMD0184	MXR
EGS	400	1996 → 1999	FMD0017	RF/MXR	FMD0184	MXR
EXC	400	1994 → 2005	FMD0017	RF/MXR	FMD0184	MXR
EXC RACING	400	2000 → 2007	FMD0017	RF/MXR		
EXC G	400	2004 → 2006			FMD0184	MXR
EXC-G RACING	400	2004 → 2007	FMD0017	RF/MXR		
EXC	400	2006 → 2011			FMD0184	MXR
EXC-G RACING	400	2008 →	FMD0017	RF/MXR		
MXC	400	2000 → 2001	FMD0017	RF/MXR		
MXC	400	2002 →	FMD0017	RF/MXR		
SX	400	2000 → 2002	FMD0017	RF/MXR	FMD0184	MXR
SX RACING	400	2002 →	FMD0017	RF/MXR		
SX	400	2003 →	FMD0017	RF/MXR		
SXC	400	1999 → 2000	FMD0017	RF/MXR		
XC W	400	2007 → 2009			FMD0184	MXR
EXC RACING	450	2003 → 2007	FMD0017	RF/MXR		
EXC	450	2008 → 2014			FMD0184	MXR
EXC R	450	2008 → 2009	FMD0017	RF/MXR	FMD0184	MXR
EXC SIX DAYS	450	2009 → 2015			FMD0184	MXR
EXC R	450	2010 → 2010	FMD0017	RF/MXR		
EXC R	450	2011 →	FMD0017	RF/MXR		
EXC-R RACING (USA)	450	2011 →	FMD0017	RF/MXR		
EXC	450	2015 →			FMD0184	MXR
EXC	450	2003 → 2007	FMD0017	RF/MXR	FMD0184	MXR
MXC	450	2003 → 2006	FMD0017	RF/MXR	FMD0184	MXR
MXC	450	2007 →	FMD0017	RF/MXR		
SMR	450	2004 → 2013			FMD0184	MXR
SMR	450	2014 →			FMD0184	MXR
SX	450	2003 → 2005	FMD0017	RF/MXR		
SX	450	2006 →	FMD0017	RF/MXR		
SX-F FACTORY REPLICA	450	2012 →	FMD0017	RF/MXR		
SX F	450	2015 →			FMD0184	MXR
SX-F	450	2003 → 2014	FMD0017	RF/MXR	FMD0184	MXR
SXS	450	2003 → 2010			FMD0184	MXR
SXS F	450	2003 → 2010			FMD0184	MXR
XC	450	2006 → 2006	FMD0017	RF/MXR		
XC G	450	2006 →			FMD0184	MXR
XC	450	2007 → 2007	FMD0017	RF/MXR	FMD0184	MXR
XC F	450	2007 → 2009			FMD0184	MXR
XC W	450	2007 → 2007			FMD0184	MXR
XC	450	2008 → 2009			FMD0184	MXR
XC W	450	2008 → 2009	FMD0017	RF/MXR	FMD0184	MXR
XC W	450	2010 →	FMD0017	RF/MXR		
XC-W SIX DAYS (USA)	450	2011 →	FMD0017	RF/MXR		
EXC/MX	500	1992 → 1995	FMD0017	RF/MXR		
EXC	500	2011 → 2011			FMD0184	MXR
EXC SIX DAYS	500	2011 → 2015			FMD0184	MXR
EXC	500	2012 → 2013	FMD0017	RF/MXR	FMD0184	MXR
EXC	500	2014 →			FMD0184	MXR

KTM



DISCS TYPE



DISCS TYPE

...KTM

LC4 EXC/EGS	500	1992 →	FMD0017	RF/MXR		
MX	500	1989 → 1991			FMD0184	MXR
MX	500	1992 → 1992			FMD0184	MXR
SX	500	1993 → 1995			FMD0184	MXR
XC-W	500	2012 → 2013	FMD0017	RF/MXR		
SX F	505	2007 → 2009	FMD0017	RF/MXR	FMD0184	MXR
XC F	505	2007 → 2009	FMD0017	RF/MXR	FMD0184	MXR
EXC RACING	520	2000 → 2001	FMD0017	RF/MXR		
EXC RACING	520	2002 →	FMD0017	RF/MXR		
EXC	520	2000 → 2002	FMD0017	RF/MXR	FMD0184	MXR
MXC	520	2001 → 2002	FMD0017	RF/MXR	FMD0184	MXR
MXC	520	2003 →	FMD0017	RF/MXR		
SX	520	2003 →	FMD0017	RF/MXR		
SX	520	2000 → 2002	FMD0017	RF/MXR	FMD0184	MXR
EXC RACING	525	2003 → 2007	FMD0017	RF/MXR		
EXC	525	2008 → 2008			FMD0184	MXR
EXC	525	2003 → 2007	FMD0017	RF/MXR	FMD0184	MXR
MXC	525	2003 → 2005	FMD0017	RF/MXR	FMD0184	MXR
SMR	525	2004 → 2005			FMD0184	MXR
SX	525	2003 → 2006	FMD0017	RF/MXR	FMD0184	MXR
SX	525	2007 → 2007	FMD0017	RF/MXR		
XC DESERT RACING	525	2006 → 2007	FMD0017	RF/MXR	FMD0184	MXR
XC	525	2006 → 2007	FMD0017	RF/MXR	FMD0184	MXR
XC G	525	2006 → 2008			FMD0184	MXR
XC W	525	2006 → 2008			FMD0184	MXR
XC	525	2008 → 2008			FMD0184	MXR
EXC R	530	2008 → 2009	FMD0017	RF/MXR	FMD0184	MXR
EXC SIX DAYS	530	2009 →			FMD0184	MXR
EXC	530	2010 → 2011			FMD0184	MXR
EXC R	530	2010 →	FMD0017	RF/MXR		
EXC-R RACING (USA)	530	2011 →	FMD0017	RF/MXR		
XC-W	530	2008 → 2010	FMD0017	RF/MXR		
XC-W	530	2011 →	FMD0017	RF/MXR		
XC-W SIX DAYS	530	2011 →	FMD0017	RF/MXR		
XC-W SIX DAYS (USA)	530	2011 →	FMD0017	RF/MXR		
SXC	540	1998 → 1998	FMD0017	RF/MXR		
SXC	540	1999 → 2000	FMD0017	RF/MXR	FMD0184	MXR
SXS	540	2001 → 2006			FMD0184	MXR
SMR	560	2006 → 2008			FMD0184	MXR
GS	600	1993 → 2000	FMD0017	RF/MXR	FMD0184	MXR
LC4	600	1990 → 1990	FMD0017	RF/MXR		
LC4	600	1991 → 1992	FMD0017	RF/MXR	FMD0184	MXR
LC4	600	1993 → 1993	FMD0017	RF/MXR		
MX	600	1990 → 1992			FMD0184	MXR
DUKE	620	1995 → 1998			FMD0184	MXR
LC4 SX	620	1995 → 1999	FMD0017	RF/MXR		
EGS-LC4	620	1996 → 2002			FMD0184	MXR
LC4 RXC	620	1996 → 1997	FMD0017	RF/MXR		
LC4 ADVENTURE	620	1997 → 1998	FMD0279	RF	FMD0184	MXR
LC4 SC SUPERCOMP	620	1998 → 2001	FMD0017	RF/MXR	FMD0184	MXR
LC4 SC	620	1998 → 2004	FMD0017	RF/MXR		
LC4 SC SUPERCOMP	620	2002 → 2004			FMD0184	MXR
LC4 SUPERMOTO	620	1999 → 2001	FMD0017	RF/MXR	FMD0184	MXR
LC4 SC SUPERCOMP	625	2002 →	FMD0017	RF/MXR	FMD0184	MXR
LC4 SUPERMOTO	625	2002 → 2004			FMD0184	MXR
LC4 SXC	625	2003 → 2007	FMD0017	RF/MXR		
SMC	625	2005 → 2007			FMD0184	MXR
SMC	625	2008 →			FMD0184	MXR
SXC	625	2003 → 2007	FMD0017	RF/MXR	FMD0184	MXR
SXC	625	2008 →			FMD0184	MXR
DUKE II	640	1999 → 2002			FMD0184	MXR
DUKE II	640	2003 → 2006	FMD0111	RX		
LC4 SUPERMOTO	640	1998 → 1999	FMD0017	RF/MXR	FMD0184	MXR
LC4 SUPERMOTO	640	2000 → 2007			FMD0184	MXR
LC4 ADVENTURE	640	2001 → 2003			FMD0184	MXR
LC4 ADVENTURE	640	2004 → 2007	FMD0279 (x2)	RF	FMD0184	MXR
LC4 ADVENTURE	640	1998 → 2000	FMD0279	RF	FMD0184	MXR
LC4 ENDURO	640	1999 → 2007	FMD0279	RF	FMD0184	MXR
SMC	660	2003 → 2007			FMD0184	MXR
DUKE	690	2008 → 2013	FMD0111 (x2)	RX		
ENDURO R	690	2008 → 2013	FMD0279	RF	FMD0459	RS/R
ENDURO	690	2008 → 2010	FMD0279	RF	FMD0459	RS/R
LC4 SUPERMOTO Prestige	690	2007 → 2007	FMD0352 (x2)	RX		
SUPERMOTO R	690	2008 → 2008	FMD0352 (x2)	RX		
LC8 ADVENTURE S	950	2004 → 2006	FMD0279 (x2)	RF	FMD0459	RS/R
LC8 ADVENTURE	950	2002 → 2006	FMD0279 (x2)	RF	FMD0459	RS/R

KTM

10024



DISCS TYPE



DISCS TYPE

...KTM

SUPER ENDURO R	950	2006 → 2008	FMD0279	RF	FMD0459	RS/R
LC8 ADVENTURE S	990	2006 → 2008	FMD0279 (x2)	RF	FMD0459	RS/R
LC8 ADVENTURE	990	2006 → 2008			FMD0459	RS/R
LC8 ADVENTURE R	990	2010 → 2012	FMD0279 (x2)	RF	FMD0459	RS/R
SUPER DUKE	990	2005 → 2011	FMD0352 (x2)	RX		
SUPER DUKE R	990	2007 → 2013	FMD0352 (x2)	RX		

KYMCO

AGILITY	50	2005 → 2008	FMD0034	R		
AGILITY R12 (Rear Drum Model)	50	2007 → 2008	FMD0034	R		
AGILITY 4T R 16	50	2008 →	FMD0323	R		
B&W EURO 2	50	2003 →	FMD0092	R		
CX CURIO SUPER	50	1994 →	FMD0006	R		
CX	50	1994 →	FMD0006	R		
DINK	50	1997 → 1998	FMD0092	R		
DINK LC	50	1998 → 2002	FMD0034	R		
DINK	50	1999 → 2001	FMD0034	R		
DINK 4T	50	2007 →	FMD0423	R		
FILLY LX	50	2001 → 2002	FMD0006	R		
HEROISM	50	1995 → 1996	FMD0006	R		
K 12	50	1995 →	FMD0006	R		
KB	50	1994 →	FMD0006	R		
LIKE 2T (Rear Drum Model)	50	2009 → 2016	FMD0452	R		
LIKE 4T (Rear Drum Model)	50	2009 → 2016	FMD0452	R		
PEOPLE S	50	2005 → 2008	FMD0323	R		
PEOPLE S 4T	50	2006 → 2008	FMD0323	R		
SNIPER	50	1993 →	FMD0006	R		
SNIPER DD	50	1994 → 1996	FMD0006	R	FMD0166	R
SUPER 9	50	2000 → 2001			FMD0034	R
SUPER 9 SPORT EURO 2	50	2003 → 2004			FMD0034	R
TOP BOY ON / OFF ROAD	50	1996 →	FMD0034	R		
VITALITY	50	2004 →	FMD0034	R		
AGILITY R12 (Rear Drum Model)	125	2005 → 2010	FMD0034	R		
AGILITY 4T	125	2005 → 2008	FMD0034	R		
AGILITY R16	125	2008 → 2017	FMD0323	R	FMD0244	R
AGILITY R16 PLUS	125	2014 → 2017	FMD0323	R	FMD0244	R
AGILITY i R16 PLUS	125	2016 → 2017	FMD0323	R	FMD0244	R
AGILITY R16 PLUS CBS	125	2017 → 2019	FMD0323	R	FMD0465	R
DINK	125	1996 → 1999	FMD0034	R	FMD0034	R
DINK	125	2000 → 2005	FMD0092	R		
DINK EURO 3	125	2006 → 2007	FMD0423	R		
DOWNTOWN i	125	2009 → 2015	FMD0439	RF	FMD0244	R
DOWNTOWN i E4	125	2016 → 2018	FMD0439	RF	FMD0244	R
DOWNTOWN NOODOE i ABS	125	2019 →	FMD0439	RF	FMD0244	R
GRAND DINK	125	2001 → 2004	FMD0092	R		
G DINK	125	2012 → 2016	FMD0244	R	FMD0453	R
G DINK	125	2017 →	FMD0244	R		
HEROISM	125	1995 → 1997	FMD0006	R		
K-XCT	125	2012 → 2016	FMD0439	RF	FMD0244	R
K-XCT	125	2017 →			FMD0244	R
LIKE	125	2009 → 2018	FMD0452	R	FMD0453	R
LIKE LX	125	2012 →	FMD0452	R	FMD0453	R
MOVIE	125	1999 → 2000	FMD0092	R		
MOVIE XL	125	2001 → 2004	FMD0092	R		
MOVIE EURO 3	125	2006 → 2007	FMD0092	R		
PEOPLE EURO 2	125	2003 → 2004	FMD0229	R		
PEOPLE S	125	2005 → 2006	FMD0323	R		
PEOPLE EURO 3	125	2007 →	FMD0229	R		
PEOPLE S DD	125	2007 → 2008	FMD0323	R	FMD0323	R
PEOPLE GTi 125	125	2010 → 2011	FMD0323	R		
PEOPLE ONE	125	2015 → 2019			FMD0453	R
PEOPLE S 125 4T (4V)	125	2017 →			FMD0465	R
SUPER DINK	125	2009 → 2013			FMD0244	R
X-TOWN i ABS/CBS	125	2015 → 2019			FMD0244	R
YAGER GTi	125	2015 → 2016			FMD0465	R
AGILITY i R16	150	2008 → 2017	FMD0323	R	FMD0244	R
AGILITY i R16 PLUS	150	2014 → 2017	FMD0323	R	FMD0244	R
AGILITY i R16 PLUS ABS	150	2018 → 2019	FMD0323	R	FMD0465	R
DINK LX	150	1998 → 2000	FMD0034	R	FMD0034	R
DINK CLASSIC	150	2002 →	FMD0092	R	FMD0034	R
DINK CLASSIC EURO 2	150	2003 →	FMD0092	R		
GRAND DINK	150	2001 → 2004	FMD0092	R		
HEROISM	150	1995 → 1997	FMD0006	R		
MOVIE XL	150	2001 → 2004	FMD0092	R		
MOVIE EURO 3	150	2006 → 2007	FMD0092	R		

KYMCO

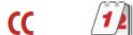

DISCS TYPE



DISCS TYPE

...KYMCO

PEOPLE S 150 4T (4V)	150	2017 →				FMD0465	R
AGILITY R16	200	2009 → 2016	FMD0323	R		FMD0244	R
AGILITY R16i PLUS	200	2014 → 2017	FMD0323	R		FMD0244	R
DINK CLASSIC	200	2004 →	FMD0092	R			
DINK EURO 3 i	200	2006 → 2007	FMD0423	R			
DOWNTOWN i	200	2010 → 2017	FMD0439	RF		FMD0244	R
LIKE 200	200	2009 → 2016	FMD0452	R		FMD0453	R
NEW DINK	200	2008 →	FMD0423	R		FMD0133	R
PEOPLE S	200	2005 → 2006	FMD0323	R			
PEOPLE S i	200	2007 → 2015	FMD0323	R		FMD0323	R
PEOPLE GT 200i	200	2010 → 2011	FMD0323	R		FMD0323	R
B&W BET & WIN	250	2000 → 2002	FMD0092	R			
B&W EURO 2	250	2003 →	FMD0092	R			
GRAND DINK	250	2001 → 2002	FMD0092	R		FMD0133	R
GRAND DINK EURO 2	250	2003 → 2004	FMD0092	R			
PEOPLE L.C.	250	2003 → 2006	FMD0323	R		FMD0323	R
PEOPLE S i	250	2006 → 2010	FMD0323 (x2)	R		FMD0323	R
XCITING	250	2005 →	FMD0440 (x2)	R			
XCITING i	250	2006 →	FMD0440 (x2)	R			
YUP	250	2003 →	FMD0092	R			
AGILITY maxi 300i ABS	300	2015 →	FMD0439	RF		FMD0244	R
DOWNTOWN i	300	2009 → 2015	FMD0439	RF		FMD0244	R
DOWNTOWN i ABS	300	2016 → 2018	FMD0439	RF		FMD0244	R
G-DINK	300	2012 →	FMD0423	R			
G DINK	300	2012 → 2016	FMD0244	R		FMD0453	R
G DINK	300	2017 →	FMD0244	R			
K-XCT i	300	2012 → 2012	FMD0439	RF			
K-XCT i	300	2013 → 2017	FMD0439	RF		FMD0244	R
K-XCT i ABS	300	2014 → 2016	FMD0439	RF			
PEOPLE S i	300	2008 → 2010	FMD0323 (x2)	R		FMD0323	R
SUPER DINK	300	2009 → 2012	FMD0439	RF		FMD0244	R
X-TOWN ABS	300	2016 → 2017	FMD0439	RF		FMD0244	R
X-TOWN ABS	300	2018 →				FMD0244	R
XCITING I	300	2008 →	FMD0440 (x2)	R			
XCITING I R	300	2008 →	FMD0440 (x2)	R			
YAGER GTI	300	2015 → 2017				FMD0465	R
DOWNTOWN i ABS	350	2015 → 2015	FMD0439	RF		FMD0244	R
DOWNTOWN i ABS E4	350	2016 → 2019	FMD0439	RF		FMD0244	R
DOWNTOWN i TCS NOODOE	350	2018 → 2019	FMD0439	RF		FMD0244	R
XCITING	500	2005 →	FMD0440 (x2)	R			
XCITING I	500	2006 → 2008	FMD0440 (x2)	R			
XCITING I R	500	2007 →	FMD0440 (x2)	R			
XCITING R	500	2009 →	FMD0440 (x2)	R			

LAVERDA

GHOST	650	1996 → 1999	FMD0111 (x2)	RX		FMD0023	R
SPORT	650	1995 → 2001	FMD0111 (x2)	RX		FMD0023	R
DIAMANTE	668	1996 → 1998				FMD0023	R
DIAMANTE / MONO LEGEND	750	1998 →				FMD0023	R
S FORMULA	750	1998 → 2001	FMD0111 (x2)	RX		FMD0023	R
STRIKE	750	1998 → 2001	FMD0111 (x2)	RX		FMD0023	R
T-8	800	1998 →				FMD0023	R
TSS	800	1999 →				FMD0023	R
SFC	1000	2003 →				FMD0005	R

LML

STAR DELUXE 4T	125	2001 → 2018	FMD0022	R			
STAR 2T	125	2010 → 2015	FMD0022	R			
STAR 4T LITE / MANUAL	125	2014 → 2018	FMD0022	R			
STAR AUTOMATIC DELUXE 4T	125	2015 → 2017	FMD0022	R			
STAR STREET POWER	125	2015 → 2017	FMD0022	R			
STAR VINTAGE POWER	125	2015 → 2017	FMD0022	R			
STAR 2T / STAR 4T	150	2010 → 2012	FMD0022	R			
STAR 4T / DELUXE 4T	200	2010 → 2018	FMD0022	R			

MACAL

BIG WARRIOR / THUNDER	50	1995 → 1996	FMD0002	R			
FLASH	50	1995 → 1997	FMD0002	R			

KYMCO

10026

FERODO

RACING

Updated on November 2020



DISCS TYPE



DISCS TYPE

MALAGUTI

CENTRO BASE	50	1993 → 1994	FMD0022	R		
CENTRO SL CAT	50	1994 → 2000	FMD0022	R		
CIAK	50	1999 → 2000	FMD0047	R		
CIAK TD	50	2000 → 2001	FMD0047	R		
CIAK TWIN DISK	50	2002 →	FMD0047	R		
CIAK MONO EURO 2,3	50	2003 →	FMD0047	R		
CIAK MASTER	50	2004 → 2005	FMD0047	R		
CIAK MASTER 4T	50	2005 → 2006	FMD0047	R		
CIAK MASTER EURO 2	50	2006 →	FMD0047	R		
CR1 CROSSER	50	1995 → 1998	FMD0002	R		
F10	50	1992 → 1998	FMD0042	R		
F10 RESTYLING	50	2001 → 2006	FMD0042	R		
F10 AC	50	2008 →	FMD0042	R		
F12 PHANTOM	50	1994 → 1998	FMD0002	R		
F12 PHANTOM LC	50	1994 → 1998	FMD0002	R		
F12 PHANTOM twin disk	50	1998 →	FMD0022	R		
F12 PHANTOM LC	50	1999 → 2000	FMD0048	R	FMD0002	R
F15 FIREFOX	50	1996 → 1997	FMD0048	R	FMD0002	R
F15 FIREFOX L.C.	50	1999 → 2005	FMD0048	R		
YESTERDAY	50	1998 →	FMD0042	R		
CIAK	100	1999 → 2001	FMD0047	R		
PHANTOM MAX	100	1999 →	FMD0048	R	FMD0002	R
CIAK	125	2000 → 2001	FMD0047	R		
CIAK RESTYLING	125	2003 →	FMD0047	R		
CIAK MASTER	125	2004 →	FMD0047	R		
CIAK MASTER EURO 3	125	2006 →	FMD0047	R		
F 18 WARRIOR	125	2000 → 2002			FMD0048	R
MADISON 3	125	2006 → 2009	FMD0371	R	FMD0371	R
CIAK	150	2000 → 2002	FMD0047	R		
CIAK MASTER	150	2003 →	FMD0047	R		
CIAK RESTYLING EURO 2	150	2004 →	FMD0047	R		
F 18 WARRIOR	150	2000 → 2002			FMD0048	R
CIAK MASTER EURO 2	200	2006 →	FMD0047	R		
MADISON S	250	1999 → 2001	FMD0046	R		
MADISON 3	250	2006 → 2009	FMD0371	R	FMD0371	R
PASSWORD	250	2005 → 2006	FMD0369	R	FMD0371	R
PASSWORD EU 3	250	2007 → 2008	FMD0369	R	FMD0371	R
MADISON K	400	2002 →			FMD0046	R
MADISON K RESTYLING	400	2002 → 2004			FMD0046	R
SPIDERMAX GT	500	2004 → 2005	FMD0369 (x2)	R		
SPIDERMAX GT EURO 3	500	2006 →	FMD0369 (x2)	R		
SPIDERMAX RS	500	2008 →	FMD0369 (x2)	R		

MASH

BIBOP / BIBOP RACING	50	2014 → 2015	FMD0097	R		
SIXTY FIVE	125	2013 → 2015	FMD0097	R		

MBK

BOOSTER 50 NAKED 13	50	2013 → 2017	FMD0097	R		
CR Z TARGET	50	1991 → 1995	FMD0001	R		
CW R BOOSTER ROAD	50	1994 → 1995	FMD0001	R		
CW RS BOOSTER NG	50	1995 → 1998	FMD0045	R		
CW BOOSTER NG	50	1995 → 1998	FMD0097	R		
CW BOOSTER SPIRIT	50	1996 → 1998	FMD0001	R		
CW RSX TRACK	50	1996 → 1998	FMD0045	R		
CW RSP BOOSTER ROCKET	50	1997 → 1998	FMD0045	R		
CW BOOSTER SPIRIT	50	1999 →	FMD0045	R		
CW RS BOOSTER NG	50	1999 → 2003	FMD0097	R		
CW BOOSTER NG	50	1999 →	FMD0002	R		
CW L BOOSTER	50	2001 →	FMD0045	R		
CW BOOSTER	50	2001 →	FMD0001	R		
YE EVOLIS	50	1992 → 1994	FMD0001	R		
YM FIZZ	50	1994 → 1995	FMD0001	R		
YA R FORTE	50	1994 → 1995	FMD0001	R		
YQ NITRO	50	1997 → 2003	FMD0097	R	FMD0097	R
OVETTO	50	1997 → 2010	FMD0002	R		
EW STUNT	50	2000 → 2002	FMD0097	R		
STUNT	50	2000 → 2006	FMD0097	R		
STUNT NAKED	50	2005 → 2010	FMD0097	R		
TARGET	50	1992 → 1994	FMD0001	R		
EVOLIS	80	1994 → 1997	FMD0001	R		
YQ NITRO	100	2000 → 2002	FMD0097	R		
OVETTO	100	1999 → 2002	FMD0002	R		
YW BOOSTER	100	1999 → 2001	FMD0363	R		

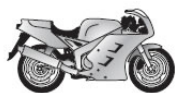

DISCS TYPE



DISCS TYPE

...MBK

YP SKYLINER	125	1998 → 2000	FMD0110	R		
YP SKYLINER	125	2001 →	FMD0110	R	FMD0156	R
XC FLAME R	125	1996 → 1999	FMD0363	R		
XN DOODO	125	2000 → 2001	FMD0110	R		
XQ THUNDER	125	2001 →			FMD0170	R
SKYLINER	150	1998 → 2000	FMD0110	R		
SKYLINER	150	2003 → 2010	FMD0110	R		
XN DOODO	150	2001 →	FMD0110	R		
YP SKYLINER	150	2000 → 2000	FMD0110	R		
YP SKYLINER	150	2001 → 2002	FMD0110	R	FMD0156	R
YP E SKYLINER	180	2003 →	FMD0110	R	FMD0156	R
YP SKYLINER	250	2000 → 2003	FMD0023	R	FMD0173	R
KILIBRE	300	2003 → 2006	FMD0319	R	FMD0320	R

MONDIAL

XR7	50	1999 →	FMD0002	R		
PIEGA (1000cc)	999	2003 →			FMD0005	R
PIEGA EVO (1000cc)	999	2003 →			FMD0005	R
PIEGA NUDA (1000cc)	999	2004 →			FMD0005	R
RZ NUDA (1000cc)	999	2002 →			FMD0005	R
RZ STARFIGHTER (1000cc)	999	2002 →			FMD0005	R

MONTESA

COTA 4RT	250	2005 → 2013	FMD0332	R	FMD0378	R
COTA 4RT	260	2014 → 2014	FMD0332	R	FMD0378	R
COTA 4RT	260	2015 →	FMD0332	R	FMD0378	R

MOTO GUZZI

BREVA	750	2003 → 2007	FMD0111	RX		
NEVADA	750	2012 → 2016	FMD0111	RX		
NEVADA	750	2003 → 2007	FMD0111	RX		
V7 CLASSIC	750	2008 → 2013	FMD0111	RX		
V7 RACER	750	2010 → 2014	FMD0111	RX		
V7 SPECIAL	750	2012 → 2014	FMD0111	RX		
V7 STONE	750	2012 → 2014	FMD0111	RX		
V7 II RACER ABS	750	2015 → 2016	FMD0111	RX		
V7 II SPECIAL ABS	750	2015 → 2016	FMD0111	RX		
V7 II STONE ABS	750	2015 → 2016	FMD0111	RX		
V7 II STORNELLO ABS	750	2016 → 2017	FMD0111	RX		
V7 III ANNIVERSARIO ABS	750	2017 →	FMD0111	RX		
V7 III RACER ABS	750	2017 →	FMD0111	RX		
V7 III SPECIAL ABS	750	2017 →	FMD0111	RX		
V7 III STONE ABS	750	2017 →	FMD0111	RX		
BREVA	850	2006 → 2008	FMD0111 (x2)	RX		
GRISO	850	2006 →	FMD0111 (x2)	RX		
NORGE T-GTL	850	2007 →	FMD0111 (x2)	RX		
V9 BOBBER ABS	850	2016 → 2017	FMD0111	RX		
V9 ROAMER ABS	850	2016 → 2017	FMD0111	RX		
BELLAGIO	940	2007 → 2013	FMD0111 (x2)	RX		
DAYTONA IE	1000	1991 → 1994	FMD0121 (x2)	RX		
DAYTONA IE	1000	1995 → 2000	FMD0111 (x2)	RX		
QUOTA	1000	1992 → 1997	FMD0077 (x2)	R		
V10 CENTAURO SPORT	1000	1998 → 2000	FMD0111	RX		
V10 CENTAURO	1000	1996 → 2001	FMD0111 (x2)	RX		
BREVA	1100	2005 → 2007	FMD0111 (x2)	RX		
CALIFORNIA EV	1100	1996 → 2000	FMD0111 (x2)	RX		
CALIFORNIA EV SPECIAL	1100	1997 → 2003	FMD0111 (x2)	RX		
CALIFORNIA JACKAL	1100	2001 → 2006	FMD0111	RX		
GRISO	1100	2005 → 2008	FMD0111 (x2)	RX		
SPORT	1100	1996 →	FMD0111 (x2)	RX		
V10 CENTAURO SPORT	1100	1998 → 2000	FMD0111 (x2)	RX		
V11 SPORT	1100	1997 → 2000	FMD0111 (x2)	RX		
V11 LE MANS	1100	2000 → 2005	FMD0111 (x2)	RX		
BREVA	1200	2008 → 2009	FMD0111 (x2)	RX		
BREVA ABS	1200	2008 → 2009	FMD0111	RX		
GRISO 8 V	1200	2007 → 2016	FMD0111 (x2)	RX		
NORGE T-GTL	1200	2006 → 2006	FMD0111 (x2)	RX		
NORGE T-GTL ABS	1200	2006 → 2009	FMD0111 (x2)	RX		
NORGE GT 8V ABS	1200	2010 → 2016	FMD0111 (x2)	RX		
SPORT ABS	1200	2006 → 2007	FMD0111 (x2)	RX		
SPORT 8V	1200	2008 → 2010	FMD0111	RX		
SPORT 8V ABS	1200	2008 → 2013	FMD0111	RX		



DISCS TYPE



DISCS TYPE

...MOTO GUZZI

STELVIO	1200	2008 → 2014	FMD0111 (x2)	RX		
STELVIO ABS	1200	2009 → 2017	FMD0111 (x2)	RX		

MOTO MORINI

9,5	1200	2006 → 2010	FMD0111 (x2)	RX		
CORSARO	1200	2005 → 2009	FMD0111 (x2)	RX		
CORSARO ZZ ABS	1200	2017 → 2018	FMD0111 (x2)	RX		
GRANPASSO	1200	2008 → 2009	FMD0121 (x2)	RX		

MOTO ROMA

GRAND PRIX	50	1999 → 2003	FMD0097	R		
GRAND PRIX	100	1999 → 2003	FMD0097	R		
GRAND PRIX	125	2002 →	FMD0097	R		

MOTOR UNION

MAXI	125	1999 →	FMD0023	R		
MAXI	150	1999 →	FMD0023	R		
MAXI	400	1999 →	FMD0023	R		

MOTRON

COMPACT RACING ES	50	1988 → 1992	FMD0042	R		
GL 4 FLASH ID	50	1989 → 1993	FMD0002	R		
RZ 1 ES	50	1989 → 1994	FMD0002	R		
SPIKE S	50	1998 →	FMD0002	R		
SYNCRO	50	1999 →	FMD0002	R		
ZR THUNDER	50	1995 →	FMD0002	R		

MZ

1000 S	1000	2001 → 2003	FMD0111 (x2)	RX		
--------	------	-------------	--------------	----	--	--

PEUGEOT

BUXY	50	1994 →	FMD0002	R		
BUXY RS	50	1994 →	FMD0002	R		
DJANGO HERITAGE	50	2014 →	FMD0048	R		
ELYSEO	50	1998 → 2001	FMD0002	R		
Jet C-Tech	50	2012 → 2013			FMD0002	R
LOOXOR	50	2001 → 2005	FMD0415	R		
LOOXOR	50	2006 →	FMD0415	R		
METAL X 50	50	2002 →	FMD0097	R		
SPEEDAKE	50	1995 →	FMD0002	R		
SPEEDFIGHT M (Pinza Heng-Tong)	50	1997 →	FMD0002	R		
SPEEDFIGHT M (Pinza AJP)	50	1997 → 1998	FMD0025	R		
SPEEDFIGHT (raff. acqua pinze AJP)	50	1998 →	FMD0025	R	FMD0025	R
SPEEDFIGHT (Pinza Brembo)	50	1996 →	FMD0002	R		
SQUAB	50	1996 →	FMD0002	R		
Streetzone 10	50	2014 → 2018	FMD0097	R		
Streetzone 12	50	2017 → 2018	FMD0097	R		
SV GEO	50	1992 →	FMD0002	R		
SV GEO (all models)	50	1993 →	FMD0002	R		
SV ROLLAND GARROS	50	1993 →	FMD0002	R		
SV SPORT	50	1993 →	FMD0002	R		
SV T (forcella telescopica)	50	1993 →	FMD0002	R		
TREKKER	50	1997 →	FMD0002	R		
TREKKER (forcelle Paioli)	50	1997 →	FMD0002	R		
TWEET	50	2010 →	FMD0446	R		
TWEET RS	50	2013 → 2017	FMD0446	R	FMD0446	R
TWEET EVO	50	2014 → 2015	FMD0446	R		
VIVACITY (forcelle Paioli)	50	1998 → 2007	FMD0002	R		
VIVACITY CATALITICO	50	2002 → 2004	FMD0097	R		
VIVACITY VSX -XR	50	2002 → 2004	FMD0097	R		
VIVACITY 4T	50	2008 →	FMD0048	R		
VIVACITY SIXTIES	50	2011 →	FMD0048	R		
X RACE	50	2002 → 2005			FMD0034	R
ZENITH	50	1994 → 1995	FMD0042	R		
ZENITH	50	1996 →	FMD0042	R		
SV EXECUTIVE	80	1996 →	FMD0002	R		
ELYSEO	100	2002 →	FMD0229	R		
ELYSEO (A.J.P.)	100	1998 → 2001	FMD0229	R		

PEUGEOT



DISCS TYPE



DISCS TYPE

...PEUGEOT

LOOXOR	100	2001 →	FMD0097	R	FMD0097	R
SPEEDFIGHT	100	1997 → 2000	FMD0025	R	FMD0025	R
TREKKER	100	1998 →	FMD0002	R		
VIVACITY	100	1999 → 2001	FMD0002	R		
ELYSEO	125	1998 → 1998	FMD0229	R		
ELYSEO	125	2000 →	FMD0229	R		
ELYSEO	125	1999 → 1999	FMD0229	R		
LOOXOR	125	2002 →	FMD0415	R		
SV GEO	125	1991 → 1992	FMD0002	R		
SV GEO	125	1993 →	FMD0002	R		
TWEET	125	2010 → 2017	FMD0446	R	FMD0446	R
TWEET PARIS	125	2015 → 2017	FMD0446	R	FMD0446	R
TWEET DOUBLE BLACK	125	2015 → 2017	FMD0446	R	FMD0446	R
TWEET i	125	2017 →	FMD0446	R	FMD0446	R
ELYSEO	150	2000 →	FMD0229	R		
LOOXOR	150	2002 → 2003	FMD0415	R		
TWEET	150	2010 → 2018	FMD0446	R	FMD0446	R
TWEET EVO	150	2014 → 2015	FMD0446	R	FMD0446	R
SV	250	2001 →	FMD0425	R		

PGO

BIG MAX	50	1994 → 2002	FMD0001	R		
CLASSIC SPORT	50	1997 →	FMD0007	R		
ENERGY EXTREME	50	1999 →	FMD0007	R		
FLY 4T	50	2006 →	FMD0022	R		
FREE	50	1995 → 2002	FMD0022	R		
I-CHARGE	50	2001 → 2002	FMD0097	R		
MEGA FIFTY	50	1999 →	FMD0001	R		
PMS	50	1999 → 2003	FMD0097	R		
PMX	50	1997 → 1999	FMD0001	R		
PMX	50	2000 → 2007	FMD0097	R	FMD0097	R
T REX	50	1999 → 2017	FMD0097	R		
TR3	50	2003 → 2004	FMD0097	R		
BIG MAX	80	1995 →	FMD0001	R		
BUBU	100	2003 → 2008	FMD0097	R		
PMS	110	1999 →	FMD0097	R		
PMX	110	2000 → 2007	FMD0097	R		
T REX	110	1999 →	FMD0097	R		
BUBU	125	2003 → 2008	FMD0097	R		
CHARGE A / B	125	2001 → 2002	FMD0097	R		
LIGERO 2T	125	2006 → 2008	FMD0097	R		
T-REX	125	1999 → 2016	FMD0097	R		

PIAGGIO

VESPA ELECTRIC 3,5 kW		2018 →	FMD0022	R		
VESPA ELECTRIC X 4V 3,5 Kw		2018 →	FMD0022	R		
VESPA 50 Primavera 4T 3V	49	2019 →	FMD0022	R		
FLY 2T	50	2004 →	FMD0022	R		
FLY 4T	50	2010 → 2017	FMD0022	R		
FLY 4T 4V i.e.	50	2012 → 2017			FMD0043	R
FLY 4T	50	2006 → 2007	FMD0022	R		
FREE (ruote in lega)	50	1996 →	FMD0022	R		
LIBERTY 2T	50	1997 → 2011	FMD0043	R		
LIBERTY 4T	50	2000 → 2009	FMD0043	R		
LIBERTY 2T / 4T	50	2012 → 2017	FMD0398	R		
NEW LIBERTY i-GET	50	2016 → 2018	FMD0398	R		
NEW LIBERTY S i-GET	50	2016 → 2016	FMD0398	R		
LIBERTY 4T / LIBERTY 4T S	50	2018 →	FMD0398	R		
NRG MC2	50	1996 →	FMD0002	R		
NRG	50	1997 →	FMD0002	R		
NRG EXTREME	50	1999 → 2000	FMD0002	R	FMD0210	R
NRG MC3	50	2001 → 2004	FMD0002	R	FMD0210	R
NRG POWER PUREJET	50	2004 → 2011	FMD0043	R		
NRG PUREJET	50	2004 → 2010	FMD0043	R		
NRG DT POWER	50	2005 → 2013	FMD0043	R		
NRG POWER DD	50	2005 → 2014	FMD0043	R		
NRG POWER DT	50	2005 → 2013	FMD0043	R		
NRG DD 2T	50	2006 → 2013	FMD0043	R		
NRG SILVER BULLET	50	2010 → 2010	FMD0043	R		
NRG	50	1994 → 1996	FMD0002	R		
NTT	50	→ 1995	FMD0002	R		
QUARTZ (Rear Drum Model)	50	1991 → 1995	FMD0022	R		
SFERA ET2	50	1997 →	FMD0022	R		
SFERA RST	50	1995 →	FMD0022	R		

PEUGEOT

10030



DISCS TYPE



DISCS TYPE

...PIAGGIO

TYPHOOM 12"	50	2010	→ 2017	FMD0007	R		
TYPHOON 2T (GRIMECA CAL./10 WHEELS)	50	2000	→ 2004	FMD0002	R		
TYPHOON 2T (HENG TONG CAL./10 WHEELS)	50	2001	→ 2009	FMD0002	R		
VESPA ET2 INIEZIONE	50	1999	→	FMD0022	R		
VESPA ET2 4T	50	2000	→ 2001	FMD0022	R		
VESPA ET4	50	2001	→ 2004	FMD0022	R		
VESPA LX 2T	50	2005	→	FMD0022	R		
VESPA LX 4T	50	2005	→	FMD0022	R		
VESPA S 2T	50	2007	→ 2013	FMD0022	R		
VESPA S 4T	50	2007	→ 2013	FMD0022	R		
VESPA S 2T SPORT	50	2011	→ 2013	FMD0022	R		
VESPA S 4T 4V SPORT	50	2011	→ 2013	FMD0022	R		
VESPA ET2	50	1997	→	FMD0022	R		
VESPA LX 4T TOURING	50	2012	→ 2013	FMD0022	R		
VESPA LXV 4T	50	2012	→ 2013	FMD0022	R		
VESPA 50 Primavera 2T / 4T 4V	50	2013	→ 2018	FMD0022	R		
VESPA 50 Primavera 4T Touring	50	2013	→ 2018	FMD0022	R		
VESPA SPRINT 50 2T	50	2014	→ 2017	FMD0022	R		
VESPA SPRINT 50 4T 3V	50	2014	→ 2019	FMD0022	R		
VESPA SPRINT S 50 2T	50	2015	→ 2017	FMD0022	R		
ZIP FAST RIDER	50	1995	→	FMD0001	R		
ZIP 4T (grimeca/heng tong caliper)	50	2000	→ 2010	FMD0210	R		
ZIP CAT DT 2T	50	2001	→ 2005	FMD0210	R		
ZIP FAST RIDER	50	1993	→ 1994	FMD0001	R		
ZIP RST	50	1996	→ 1999	FMD0001	R		
ZIP SP	50	1996	→	FMD0022	R		
SKIPPER	80	1994	→ 1995	FMD0022	R		
FREE	100	2001	→	FMD0043	R		
VESPA 946 4T/3V ARMANI	125	2014	→ 2017	FMD0043	R		
BEVERLY	125	2001	→ 2007	FMD0055	R	FMD0055	R
BEVERLY RST	125	2004	→ 2007	FMD0055	R	FMD0055	R
BEVERLY EURO 3	125	2007	→ 2008	FMD0055	R	FMD0055	R
BEVERLY EURO 3 MIC	125	2007	→ 2007	FMD0055	R	FMD0055	R
BEVERLY EURO 3 SPORT	125	2007	→ 2010	FMD0055	R	FMD0055	R
BEVERLY S	125	2007	→ 2007	FMD0055	R	FMD0055	R
BEVERLY EURO 3 TOURER	125	2008	→ 2010	FMD0055	R	FMD0055	R
BEVERLY S	125	2008	→ 2010	FMD0053	R	FMD0053	R
BEVERLY RST 4T 4V IE EURO 3	125	2010	→ 2011	FMD0055	R	FMD0055	R
BEVERLY NEW i.e.	125	2016	→ 2016	FMD0053	R		
CARNABY	125	2007	→ 2010	FMD0055	R	FMD0055	R
FLY	125	2005	→ 2008	FMD0022	R		
FLY 125 4T 3V	125	2012	→ 2017			FMD0043	R
VESPA GTS	125	2007	→ 2012	FMD0043	R	FMD0043	R
VESPA GTS 4T SUPER i.e.	125	2008	→ 2016	FMD0043	R	FMD0043	R
VESPA GTS SUPERSPORT i.e.	125	2013	→ 2016	FMD0043	R	FMD0043	R
VESPA GTS 4T SUPER i.e. ABS	125	2014	→ 2016	FMD0043	R	FMD0043	R
VESPA GTS 4T i.e. ABS E4	125	2016	→ 2018	FMD0043	R	FMD0043	R
VESPA GTS TOURING ABS	125	2018	→	FMD0043	R	FMD0043	R
HEXAGON	125	1994	→ 1997	FMD0040	R		
HEXAGON LX	125	1998	→ 2001	FMD0022	R		
LIBERTY 2T	125	1998	→ 2002	FMD0043	R		
LIBERTY 4T	125	2006	→ 2008	FMD0043	R		
LIBERTY 4T SPORT	125	2006	→ 2009	FMD0043	R		
LIBERTY 4T S	125	2006	→ 2008	FMD0043	R		
LIBERTY 4T	125	2009	→ 2013	FMD0398	R		
Medley 125 i-Get ABS	125	2016	→	FMD0050	R		
Medley 125 i-Get S ABS	125	2016	→	FMD0050	R		
Medley 125 i-Get Sp. Edition ABS	125	2017	→	FMD0050	R		
MP3 125	125	2006	→ 2008	FMD0398 (x2)	R	FMD0054	R
MP3 IE	125	2008	→ 2009	FMD0398 (x2)	R	FMD0054	R
MP3 IBRIDO	125	2009	→ 2010	FMD0398 (x2)	R	FMD0054	R
MP3 IE TOURING	125	2011	→ 2012	FMD0398 (x2)	R	FMD0054	R
MP3 YOURBAN ERL	125	2011	→ 2013	FMD0398 (x2)	R	FMD0054	R
VESPA PRIMAVERA 4T i.e. 3V	125	2015	→ 2018	FMD0022	R		
VESPA PRIMAVERA S ABS 4T i.e. 3V	125	2015	→ 2018	FMD0022	R		
VESPA PRIMAVERA 70	125	2015	→ 2016	FMD0022	R		
SFERA 4T	125	1995	→ 1997	FMD0022	R		
SKIPPER LX	125	1998	→ 2002	FMD0007	R		
SKIPPER 4T	125	1998	→	FMD0007	R		
SKIPPER ST 4T (grimeca caliper)	125	2000	→ 2004	FMD0007	R		
SKIPPER ST 4T (heng tong caliper)	125	2000	→ 2004	FMD0007	R		
VESPA SPRINT / S 4T i.e. 3V / ABS	125	2015	→ 2018	FMD0022	R		
VESPA SPRINT SPORT ABS	125	2017	→ 2017	FMD0022	R		
SUPER HEXAGON GTX	125		→ 2000	FMD0022	R	FMD0022	R
SUPER HEXAGON GTX	125	2001	→ 2002	FMD0054	R	FMD0043	R
TYPHOOM 4T 12"	125	2010	→ 2017	FMD0007	R		



DISCS TYPE



DISCS TYPE

...PIAGGIO

VESPA PX	125	1998	→	FMD0022	R		
VESPA GRANTURISMO L (pinza Grimeca)	125	2003	→	FMD0043	R	FMD0043	R
VESPA GRANTURISMO L (pinza HengTong)	125	2003	→	FMD0043	R	FMD0043	R
VESPA LX	125	2005	→ 2006	FMD0022	R		
VESPA LX EURO 3	125	2006	→ 2007	FMD0022	R		
VESPA S 4T IE & COLLEGE	125	2009	→ 2010	FMD0022	R		
VESPA S 4T 3V SPORT	125	2011	→ 2013	FMD0022	R		
VESPA ET4	125	1996	→ 2002	FMD0022	R		
VESPA 946 4T/3V ABS	125	2013	→ 2019	FMD0043	R		
VESPA 946 RED 4T/3V ABS	125	2017	→ 2019	FMD0043	R		
Vespa GTV	125	2006	→ 2008	FMD0043	R	FMD0043	R
X EVO	125	2004	→ 2017	FMD0055	R	FMD0054	R
X EVO SPORT	125	2015	→ 2017	FMD0055	R	FMD0054	R
X7	125	2007	→ 2009	FMD0055	R		
X7 EURO3	125	2008	→ 2009	FMD0055	R		
X7 EVO IE EURO3	125	2009	→ 2010	FMD0055	R		
X8	125	2004	→	FMD0055	R	FMD0054	R
X8 (pinza HengTong)	125	2005	→ 2006	FMD0055	R	FMD0054	R
X8 PREMIUM EURO 2	125	2006	→	FMD0055	R	FMD0054	R
X8 STREET EURO 3	125	2006	→	FMD0055	R		
X9 EVOLUTION	125	2001	→ 2007	FMD0053 (x2)	R	FMD0053	R
FLY	150	2005	→ 2007	FMD0022	R		
FLY EURO 3	150	2008	→ 2010	FMD0022	R		
HEXAGON	150	1994	→ 1999	FMD0040	R		
HEXAGON LX	150	1998	→	FMD0022	R		
LIBERTY LE 4T	150	1999	→ 2003	FMD0043	R		
LIBERTY 4T	150	2008	→ 2013	FMD0043	R		
LIBERTY 4T SPORT	150	2008	→ 2008	FMD0043	R		
Medley 150 i-Get ABS	150	2016	→	FMD0050	R		
Medley 150 i-Get S ABS	150	2016	→	FMD0050	R		
Medley 150 i-Get Sp.Edition ABS	150	2017	→	FMD0050	R		
Vespa 150 Primavera 4T 3V	150	2013	→ 2015	FMD0022	R		
Vespa 150 Primavera Touring 3V	150	2015	→ 2015	FMD0022	R		
SKIPPER LXT	150	1998	→ 2006	FMD0007	R		
SKIPPER LX	150	1998	→ 2006	FMD0007	R		
SKIPPER 4T	150	2000	→ 2002	FMD0007	R		
VESPA SPRINT S 4T 3V ABS	150	2015	→ 2016	FMD0022	R		
VESPA ET4	150	1996	→ 2002	FMD0022	R		
VESPA PX	150	1998	→	FMD0022	R		
VESPA LX	150	2005	→ 2006	FMD0022	R		
VESPA LX EURO 3	150	2006	→ 2007	FMD0022	R		
VESPA S 4T IE & COLLEGE	150	2009	→ 2010	FMD0022	R		
VESPA 150 GTS i.e. ABS E4	150	2016	→ 2017	FMD0043	R	FMD0043	R
X8 STREET EURO 3	150	2006	→	FMD0055	R		
HEXAGON LX	180	1998	→	FMD0022	R		
SUPER HEXAGON GTX	180		→ 2000	FMD0022	R	FMD0022	R
SUPER HEXAGON GTX	180	2001	→ 2004	FMD0054	R	FMD0043	R
X9 AMALFI	180	2000	→ 2003	FMD0053 (x2)	R	FMD0053	R
BEVERLY	200	2001	→ 2006	FMD0055	R	FMD0055	R
BEVERLY (pinza HengTong)	200	2001	→ 2006	FMD0055	R	FMD0055	R
CARNABY	200	2007	→ 2010	FMD0055	R	FMD0055	R
LIBERTY RST	200	2004	→ 2005	FMD0043	R		
LIBERTY	200	2006	→	FMD0043	R		
LIBERTY 4T SPORT EURO 3	200	2006	→ 2007	FMD0043	R		
LIBERTY SPORT	200	2006	→	FMD0043	R		
LIBERTY 4T EURO3	200	2007	→ 2008	FMD0043	R		
VESPA PE	200	1998	→	FMD0022	R		
VESPA PX	200	1998	→	FMD0022	R		
VESPA GRANTURISMO L (pinza Grimeca)	200	2003	→ 2005	FMD0043	R	FMD0043	R
VESPA GRANTURISMO L (pinza Heng Tong)	200	2003	→ 2005	FMD0043	R	FMD0043	R
VESPA GRANTURISMO (pinza Grimeca)	200	2006	→	FMD0043	R	FMD0043	R
VESPA GRANTURISMO (pinza Heng Tong)	200	2006	→	FMD0043	R	FMD0043	R
X8	200	2004	→ 2005	FMD0055	R	FMD0054	R
X8 (pinza HengTong)	200	2005	→	FMD0168	R	FMD0054	R
X8 EVO	200	2005	→ 2007	FMD0055	R		
X8	200	2006	→	FMD0055	R	FMD0054	R
X9 EVOLUTION	200	2002	→ 2003	FMD0053 (x2)	R	FMD0053	R
BEVERLY LEADER	250	2004	→	FMD0055	R	FMD0055	R
BEVERLY RST	250	2004	→ 2005	FMD0055	R	FMD0055	R
BEVERLY	250	2006	→ 2007	FMD0055	R	FMD0055	R
BEVERLY EURO 3 IE	250	2006	→ 2008	FMD0055	R	FMD0055	R
BEVERLY SPORT	250	2006	→ 2008	FMD0055	R	FMD0055	R
BEVERLY CRUISER	250	2007	→ 2009	FMD0055	R	FMD0055	R
BEVERLY EURO 3 MIC	250	2007	→	FMD0055	R	FMD0055	R
BEVERLY EURO 3 TOURER	250	2008	→ 2009	FMD0055	R	FMD0055	R
CARNABY	250	2008	→	FMD0055	R	FMD0055	R

PIAGGIO

10032



DISCS TYPE



DISCS TYPE

...PIAGGIO

VESPA GT 60	250	2006 → 2007	FMD0043	R	FMD0043	R
VESPA GTS	250	2005 → 2014	FMD0043	R	FMD0043	R
HEXAGON	250	1998 →	FMD0022	R		
MP3	250	2006 → 2008	FMD0398 (x2)	R	FMD0054	R
MP3 LT	250	2008 → 2009	FMD0398 (x2)	R	FMD0054	R
MP3 MIC	250	2008 → 2009	FMD0398 (x2)	R	FMD0054	R
SUPER HEXAGON GT-GTX	250	2000 →	FMD0022	R	FMD0022	R
VESPA GTV	250	2006 →	FMD0043	R	FMD0043	R
X EVO	250	2007 → 2013	FMD0055	R	FMD0054	R
X EVO SPORT	250	2015 → 2017	FMD0055	R	FMD0054	R
X7 EURO 3	250	2008 →	FMD0055	R		
X8	250	2005 →	FMD0055	R		
X9	250	2000 → 2003	FMD0053 (x2)	R	FMD0053	R
X9 AMALFI	250	2000 →	FMD0053 (x2)	R	FMD0053	R
X9 EVOLUTION	250	2004 → 2006	FMD0053 (x2)	R	FMD0053	R
BEVERLY TOURER EURO 3	300	2009 → 2010	FMD0055	R	FMD0055	R
CARNABY CRUISER	300	2008 → 2013	FMD0055	R	FMD0055	R
VESPA GTS 300 Super i.e.	300	2008 → 2019	FMD0043	R	FMD0043	R
VESPA GTS 300 Super Sport	300	2010 → 2019	FMD0043	R	FMD0043	R
VESPA GTS 300	300	2010 → 2019	FMD0043	R	FMD0043	R
VESPA GTS 300 i.e. Touring	300	2010 → 2019	FMD0043	R	FMD0043	R
VESPA GTS 300 ABS - ASR NOTTE	300	2018 → 2019	FMD0043	R	FMD0043	R
VESPA GTS 300 ABS - ASR YACHT CLUB	300	2018 → 2019	FMD0043	R	FMD0043	R
VESPA GTS 300 SUPER TECH Hpe	300	2019 →	FMD0043	R	FMD0043	R
VESPA GTS 300 HPE	300	2019 →	FMD0043	R	FMD0043	R
VESPA GTS 300 Super HPE	300	2019 →	FMD0043	R	FMD0043	R
VESPA GTS 300 i.e. Touring HPE	300	2019 →	FMD0043	R	FMD0043	R
VESPA GTS 300 Super Sport HPE	300	2019 →	FMD0043	R	FMD0043	R
MP3 4T 4V IE ERL IBRIDO	300	2010 → 2017	FMD0398 (x2)	R	FMD0054	R
MP3 IE LT	300	2010 → 2011	FMD0398 (x2)	R	FMD0054	R
MP3 IE MIC	300	2010 → 2013	FMD0398 (x2)	R	FMD0054	R
MP3 IE LT - IE LT SPORT	300	2011 → 2013	FMD0398 (x2)	R	FMD0054	R
MP3 IE LT TOURING	300	2011 → 2013	FMD0398 (x2)	R	FMD0054	R
MP3 IE TOURING	300	2011 → 2012	FMD0398 (x2)	R	FMD0054	R
MP3 YOURBAN ERL	300	2011 → 2015	FMD0398 (x2)	R	FMD0054	R
MP3 YOURBAN LT ERL	300	2011 → 2012	FMD0398 (x2)	R	FMD0054	R
MP3 LT BUSINESS ABS	300	2014 →			FMD0054	R
MP3 SPORT ABS	300	2014 →			FMD0054	R
MP3 i.e. S YOURBAN	300	2018 →			FMD0054	R
MP3 300 HPE	300	2019 →	FMD0398 (x2)	R	FMD0054	R
MP3 300 HPE Sport	300	2019 →			FMD0054	R
VESPA Sei Giorni	300	2017 → 2019	FMD0043	R	FMD0043	R
X7 EVO IE EURO3	300	2009 → 2011	FMD0055	R		
X7 EVO IE	300	2011 →	FMD0055	R		
MP3 ABS/LT/SPORT	350	2018 →			FMD0054	R
BEVERLY EURO 3	400	2006 → 2008	FMD0168	R	FMD0054	R
BEVERLY TOURER EURO3	400	2008 → 2010	FMD0055 (x2)	R		
MP3	400	2007 → 2008	FMD0398 (x2)	R	FMD0054	R
MP3 IE LT - IE LT SPORT	400	2008 → 2010	FMD0398 (x2)	R	FMD0054	R
MP3 MIC	400	2008 → 2010	FMD0398 (x2)	R	FMD0054	R
MP3 LT	400	2009 →	FMD0398 (x2)	R	FMD0054	R
MP3 IE LT TOURING	400	2011 →	FMD0398 (x2)	R	FMD0054	R
MP3 RL TOURING	400	2011 →	FMD0398 (x2)	R	FMD0054	R
X8	400	2006 → 2008	FMD0055 (x2)	R	FMD0054	R
BEVERLY	500	2002 → 2006	FMD0055 (x2)	R	FMD0054	R
BEVERLY EURO 3	500	2006 →	FMD0055 (x2)	R	FMD0054	R
BEVERLY CRUISER	500	2007 → 2012	FMD0055 (x2)	R	FMD0054	R
MP3 TOURING SPORT / BUSINESS	500	2012 → 2015	FMD0398 (x2)	R	FMD0054	R
MP3 LT hpe BUSINESS	500	2016 → 2019			FMD0054	R
MP3 LT SPORT	500	2016 → 2018			FMD0054	R
MP3 BUSSINESS HPE	500	2018 →			FMD0054	R
MP3 TOURING SPORT hpe ABS	500	2018 →			FMD0054	R
MP3 TOURING SPORT hpe ADVANCED ABS	500	2018 →			FMD0054	R
X9	500	2001 → 2003	FMD0055 (x2)	R	FMD0054	R
X9 EVOLUTION	500	2003 → 2004	FMD0168 (x2)	R	FMD0054	R
X9 EVOLUTION ABS	500	2006 → 2007	FMD0168 (x2)	R	FMD0054	R

RIEJU

BLAST URBAN	50	2016 → 2018	FMD0097	R		
FIRST H2O	50	1997 →	FMD0002	R		
MRT SUPERMOTO	50	2012 → 2013	FMD0002	R		
RS BLAST URBAN	50	2014 → 2018	FMD0097	R		
RS SPORT / NAKED	50	2014 → 2018	FMD0097	R	FMD0097	R



DISCS TYPE



DISCS TYPE

SCORPA

SY F	125	2003	→	FMD0381	R	FMD0382	R
TY (4T)	125	2005	→	FMD0381	R	FMD0382	R
SY F RACING	175	2005	→	FMD0381	R	FMD0382	R
SY	250	2000	→	FMD0381	R	FMD0382	R
SY LONG RIDE	250	2004	→	FMD0381	R	FMD0382	R
SY R	250	2005	→	FMD0381	R	FMD0382	R

SHERCO

CITY CORP 4T ENDURO	125	2003	→	FMD0332	R	FMD0333	R
CITY CORP 4T SM	125	2003	→	FMD0332	R	FMD0333	R
TRIAL	125	1999	→	FMD0332	R	FMD0333	R
TRIAL 1.25	125	2006	→	FMD0332	R	FMD0333	R
SE ENDURO 2.5 I	250	2006	→ 2011	FMD0330	R	FMD0335	R
TRIAL 2.5	250	2001	→	FMD0332	R	FMD0333	R
TRIAL 2.9	290	2001	→	FMD0332	R	FMD0333	R
TRIAL 3.2 4T	320	2005	→	FMD0332	R	FMD0333	R
ENDURO 4.5 I	450	2004	→ 2011	FMD0330	R	FMD0335	R
SE ENDURO 5.1 I	510	2006	→ 2011	FMD0330	R	FMD0335	R

SINNIS

LJ QT-H	50	2012	→ 2014	FMD0097	R	FMD0097	R
---------	----	------	--------	---------	---	---------	---

SUZUKI

BURGMAN FULL CELL		2012	→ 2015	FMD0441	R	FMD0441	R
RM	80	1990	→ 2001	FMD0151	R	FMD0251	R
RM	85	2002	→ 2004	FMD0151	R	FMD0251	R
RM	85	2005	→ 2007			FMD0342	R
BURGMAN UH	125	2002	→ 2006	FMD0324	R	FMD0318	R
BURGMAN UH	125	2007	→ 2013	FMD0441	R	FMD0441	R
BURGMAN UH RACING	125	2013	→ 2014	FMD0441	R	FMD0441	R
RG F GAMMA	125	1992	→ 1994	FMD0118	RX		
RM	125	2001	→ 2012	FMD0028	RF/MXR	FMD0248	MXR
RM	125	1988	→ 2000	FMD0028	RF/MXR	FMD0186	MXR
TS R	125	1989	→	FMD0027	R		
BURGMAN UH	150	2002	→ 2006	FMD0324	R	FMD0318	R
BURGMAN UH	200	2007	→ 2014	FMD0441	R	FMD0441	R
TS R	200	1989	→	FMD0027	R		
BURGMAN	250	1996	→ 1997			FMD0250	R
BURGMAN AN	250	2003	→ 2006	FMD0334	R	FMD0361	R
BURGMAN	250	1998	→ 2002	FMD0026	R	FMD0250	R
DR S	250	1990	→			FMD0242	R
GSF BANDIT	250	1990	→	FMD0119	RX		
RGV GAMMA	250	1991	→ 1997	FMD0118 (x2)	RX		
RM	250	1989	→ 2000	FMD0028	RF/MXR	FMD0186	MXR
RM	250	2001	→ 2012	FMD0028	RF/MXR	FMD0248	MXR
RMX	250	1989	→ 1999	FMD0028	RF/MXR	FMD0186	MXR
RMX S	250	1992	→ 1998	FMD0028	RF/MXR		
RMZ	250	2004	→ 2006			FMD0239	MXR
RMZ	250	2007	→ 2018	FMD0396	MXR	FMD0366	MXR
DR S-R	350	1989	→ 1999			FMD0242	R
DR S	350	1989	→ 1993			FMD0242	R
DR R	350	1994	→ 1999			FMD0242	R
DR S	350	1996	→ 1999			FMD0242	R
BURGMAN AN	400	1999	→ 2002	FMD0026	R	FMD0250	R
BURGMAN AN	400	2003	→ 2006	FMD0334	R	FMD0361	R
BURGMAN AN	400	2007	→ 2015	FMD0334 (x2)	R	FMD0421	R
BURGMAN AN ABS	400	2011	→ 2019	FMD0334 (x2)	R	FMD0421	R
DR Z E	400	2000	→ 2017	FMD0028	RF/MXR	FMD0186	MXR
DR Z S	400	2000	→ 2017	FMD0028	RF/MXR	FMD0186	MXR
DR Z SM	400	2005	→ 2017			FMD0248	MXR
GS	400	1989	→ 1989	FMD0119	RX	FMD0246	R
GSF BANDIT	400	1989	→ 1996	FMD0119	RX	FMD0246	R
RMX EFI	450	2010	→ 2012	FMD0396	MXR	FMD0366	MXR
RMZ	450	2005	→ 2007	FMD0396	MXR	FMD0366	MXR
RMZ EFI	450	2008	→ 2017	FMD0396	MXR	FMD0366	MXR
RMZ EFI	450	2018	→			FMD0366	MXR
GS E	500	1989	→ 2003	FMD0119	RX	FMD0246	R
GS F	500	2004	→ 2007	FMD0119	RX	FMD0246	R
DR S	600	1986	→ 1988	FMD0027	R		
DR R	600	1986	→ 1989	FMD0027	R		
DR DJEBEL	600	1989	→	FMD0027	R	FMD0187	R
DR R DAKAR-DJEBEL	600	1987	→ 1988	FMD0027	R		

SCORPA



CC



DISCS TYPE



DISCS TYPE

...SUZUKI

GSF BANDIT	600	1995 → 1999	FMD0120 (x2)	RX	FMD0244	R
GSF BANDIT	600	2000 → 2004	FMD0120 (x2)	RX	FMD0244	R
GSR	600	2006 → 2008			FMD0448	R
GSX F	600	1988 → 1997			FMD0246	R
GSX F	600	1998 → 2003	FMD0120 (x2)	RX	FMD0244	R
GSX F	600	2004 → 2006	FMD0349 (x2)	RX	FMD0244	R
GSX R	600	2004 → 2005	FMD0241 (x2)	RX	FMD0249	R
GSX R (Rad.cal)	600	2006 → 2007	FMD0393 (x2)	RX	FMD0249	R
GSX R	600	2006 → 2007	FMD0393 (x2)	RX	FMD0249	R
GSX R	600	2008 → 2017	FMD0412 (x2)	RX	FMD0249	R
GSX R	600	1997 → 2003	FMD0125 (x2)	RX	FMD0249	R
GSX R (Rad.cal)	600	2004 → 2005	FMD0241 (x2)	RX	FMD0249	R
RF R	600	1993 → 1997	FMD0120 (x2)	RX	FMD0244	R
BURGMAN AN (5 fori / holes)	650	2004 → 2012	FMD0334 (x2)	R	FMD0362	R
BURGMAN AN ABS	650	2004 → 2015	FMD0334 (x2)	R	FMD0362	R
BURGMAN AN ABS EXECUTIVE	650	2013 → 2018	FMD0334 (x2)	R	FMD0362	R
DR DJEBEL	650	1990 → 1990	FMD0148	R	FMD0187	R
DR RS	650	1990 → 1991	FMD0148	R	FMD0187	R
DR DJEBEL	650	1991 → 1995			FMD0187	R
DR RSE	650	1991 → 1993			FMD0187	R
DR RE	650	1994 → 1995			FMD0187	R
DR R	650	1990 → 1993			FMD0187	R
GSF BANDIT	650	2005 → 2006	FMD0349 (x2)	RX	FMD0244	R
GSF BANDIT S	650	2005 → 2006	FMD0349 (x2)	RX	FMD0244	R
GSF BANDIT ABS	650	2005 → 2006			FMD0448	R
GSF BANDIT S ABS	650	2007 → 2011			FMD0448	R
GSX F	650	2008 → 2012			FMD0448	R
SFV GLADIUS	650	2009 → 2012			FMD0448	R
SV	650	1999 → 2002	FMD0120 (x2)	RX	FMD0244	R
SV S	650	1999 → 2002	FMD0120 (x2)	RX	FMD0244	R
SV	650	2003 → 2010	FMD0349 (x2)	RX	FMD0249	R
SV S	650	2003 → 2009	FMD0349 (x2)	RX	FMD0249	R
SV ABS	650	2003 → 2012			FMD0448	R
DR BIG S	750	1987 → 1988	FMD0148	R		
DR BIG	750	1988 → 1989			FMD0187	R
GSR	750	2011 → 2012			FMD0448	R
GSX R	750	1985 → 1988			FMD0244	R
GSX	750	1989 → 1992			FMD0246	R
GSX R	750	1989 → 1995	FMD0117 (x2)	RX	FMD0244	R
GSX R LIMITED EDITION	750	1989 → 1990	FMD0117 (x2)	RX		
GSX R W	750	1994 → 1995	FMD0117 (x2)	RX	FMD0244	R
GSX R	750	1996 → 2003	FMD0125 (x2)	RX	FMD0249	R
GSX	750	1997 → 2003	FMD0118 (x2)	RX	FMD0244	R
GSX F	750	1998 → 2003	FMD0120 (x2)	RX	FMD0244	R
GSX F	750	2004 → 2006	FMD0349 (x2)	RX	FMD0244	R
GSX R	750	2004 → 2005	FMD0241 (x2)	RX	FMD0249	R
GSX R	750	2006 → 2007	FMD0393 (x2)	RX	FMD0249	R
GSX R (Rad.cal)	750	2006 → 2007	FMD0393 (x2)	RX	FMD0249	R
GSX R	750	2008 → 2017	FMD0412 (x2)	RX	FMD0249	R
GSX R (Rad.cal)	750	2004 → 2005	FMD0241 (x2)	RX	FMD0249	R
GSX R Y	750	2000 → 2003	FMD0125 (x2)	RX	FMD0249	R
DR BIG S	800	1989 → 1990	FMD0148	R	FMD0187	R
DR BIG S	800	1991 → 1996			FMD0187	R
VX	800	1994 →			FMD0247	R
VX	800	1990 → 1993			FMD0247	R
VZ MARAUDER	800	1996 → 2004	FMD0118	RX		
RF	900	1994 → 1997	FMD0119 (x2)	RX	FMD0244	R
GSX R (Rad.cal)	1000	2005 → 2008	FMD0393 (x2)	RX	FMD0249	R
GSX R	1000	2005 → 2008	FMD0393 (x2)	RX	FMD0249	R
GSX R	1000	2009 → 2015	FMD0412 (x2)	RX	FMD0249	R
GSX R	1000	2001 → 2002	FMD0125 (x2)	RX	FMD0249	R
GSX R	1000	2003 → 2004	FMD0241 (x2)	RX	FMD0249	R
GSX R ABS	1000	2016 →	FMD0412 (x2)	RX	FMD0249	R
SV	1000	2003 → 2007			FMD0249	R
SV S	1000	2003 → 2007			FMD0249	R
TL S	1000	1997 → 2001	FMD0125 (x2)	RX	FMD0249	R
TL R	1000	1998 → 2003	FMD0125 (x2)	RX	FMD0249	R
GSX R	1100	1989 → 2000	FMD0117 (x2)	RX	FMD0244	R
GSX R	1100	1987 → 1988			FMD0249	R
GSF BANDIT	1200	1996 → 2005	FMD0119 (x2)	RX	FMD0244	R
GSF BANDIT	1200	2006 → 2006			FMD0448	R
GSF S BANDIT	1200	2006 → 2006			FMD0448	R
GSX INAZUMA	1200	1999 → 2002	FMD0119 (x2)	RX	FMD0244	R
GSF BANDIT	1250	2007 → 2012			FMD0448	R
GSX FA	1250	2010 → 2012			FMD0448	R
GSX R HAYABUSA	1300	1999 → 2007	FMD0125 (x2)	RX	FMD0244	R

SUZUKI



DISCS TYPE



DISCS TYPE

...SUZUKI

GSX 1400 2002 → 2007

FMD0125 (x2) RX

VZR INTRUDER M 1800 2008 → 2012

FMD0393 (x2) RX

SWM

RS 300 R 298 2015 → 2017

FMD0335 R

SYM

ALLO 50 2012 → 2013

FMD0002 R

CINDERELLA 50 1999 → 2002

FMD0006 R

JET 4 50 2009 → 2010

FMD0446 R

MIO 50 2006 → 2007

FMD0006 R

Orbit II 50 (4T) 50 2014 → 2018

FMD0002 R

Orbit II 50 Naked (4T) 50 2014 → 2018

FMD0002 R

Orbit II 50 TS (4T) 50 2014 → 2018

FMD0002 R

SUPER FANCY 50 1999 → 2000

FMD0006 R

SYMPHONY 50 2009 → 2009

FMD0446 R

SYMPHONY S 50 2010 →

FMD0446 R

SYMPHONY SR 4T 50 2010 → 2018

FMD0446 R

FMD0446 R

SYMPLY II 50 50 2014 → 2015

FMD0002 R

X'Pro 50 2012 → 2017

FMD0097 R

CINDERELLA 100 1999 →

FMD0006 R

ALLO 4T 125 2012 → 2017

FMD0002 R

ATTILA 125 1995 → 1998

FMD0006 R

EURO MX 125 2002 →

FMD0416 R

EURO MX E2 125 2003 → 2004

FMD0416 R

FIDDLE III 125 4T CBS 12" wheels 125 2014 → 2018

FMD0002 R

GTS 125 2006 → 2007

FMD0420 R

FMD0418 R

HD 125 EURO 2 125 2003 → 2004

FMD0417 R

HD EVO 125 2005 → 2006

FMD0417 R

FMD0419 R

HD EVO EURO3 125 2010 →

FMD0419 R

FMD0419 R

JET 4 125 2009 → 2009

FMD0446 R

JOYRIDE 125 2001 → 2004

FMD0416 R

FMD0418 R

JOYRIDE EURO 2 125 2005 → 2006

FMD0416 R

FMD0418 R

JOYRIDE EURO 3 125 2007 → 2009

FMD0416 R

FMD0418 R

JOYRIDE EVO 125 2010 →

FMD0416 R

FMD0418 R

MEGALO 125 2006 → 2007

FMD0006 R

NEW DUKE 125 2000 → 2001

FMD0006 R

SHARK 125 1999 → 1999

FMD0416 R

SHARK 125 2000 →

FMD0416 R

SR 125 1998 →

FMD0006 R

SUPER DUKE 125 1999 → 2002

FMD0006 R

SYMPHONY 125 2009 → 2018

FMD0446 R

SYMPHONY DD 125 2009 → 2009

FMD0446 R

SYMPHONY S 125 2010 → 2019

FMD0446 R

SYMPHONY SR 4T 125 2010 → 2017

FMD0446 R

FMD0446 R

VS 125 2006 →

FMD0416 R

VS EURO 3 125 2007 → 2008

FMD0416 R

X'Pro 125 2012 → 2017

FMD0097 R

ALLO / FIDDLE II 150 2012 → 2013

FMD0002 R

ATTILA 150 2000 → 2001

FMD0006 R

EURO MX 150 2002 →

FMD0416 R

EURO MX EU 2 150 2003 → 2004

FMD0416 R

JOYRIDE 150 2001 → 2002

FMD0416 R

FMD0418 R

SHARK 150 2000 → 2001

FMD0416 R

SYMPHONY 150 2009 → 2009

FMD0446 R

SYMPHONY S 150 2010 → 2014

FMD0446 R

SYMPHONY SR 150 2010 → 2014

FMD0446 R

FMD0446 R

VS 150 2007 →

FMD0416 R

VS EURO 3 150 2007 → 2008

FMD0416 R

FIDDLE III 200 2014 → 2015

FMD0097 R

FIDDLE III i ABS 200 2016 → 2019

FMD0097 R

HD EU 2 200 2003 → 2004

FMD0417 R

HD EVO EURO 2 200 2005 → 2006

FMD0417 R

FMD0419 R

HD EVO I EURO 3 200 2007 → 2010

FMD0417 R

FMD0419 R

HD EVO 200 2011 →

FMD0419 R

FMD0419 R

HD2 EVO 200 2013 →

FMD0419 R

FMD0419 R

JOY RIDE 200 2001 → 2004

FMD0416 R

FMD0418 R

JOY RIDE I EVO 200 2009 → 2010

FMD0416 R

FMD0418 R

GTS 250 2006 → 2008

FMD0420 R

FMD0419 R

JOYMAX 250 2005 → 2007

FMD0420 (x2) R

FMD0419 R

JOYMAX I EURO 3 250 2007 → 2008

FMD0420 R

FMD0419 R

JOYMAX EVO 300 2009 →

FMD0420 R

FMD0419 R

JOYMAX I EVO 300 2010 →

FMD0420 R

FMD0419 R

JOYMAX I 300 2012 →

FMD0420 R

FMD0419 R

SUZUKI

10036

FERODO

RACING

Updated on November 2020



CC



DISCS TYPE



DISCS TYPE

TGB

101 R	50	2004 → 2009	FMD0097	R
202 CLASSIC	50	2003 → 2014	FMD0097	R
303 REVOLUTION / RS	50	2002 → 2003	FMD0097	R
303 R LASER / R HAWK	50	2004 → 2014	FMD0097	R
AKROS TEC	50	1994 → 2004	FMD0097	R
BULLET R X	50	2017 → 2018	FMD0097	R
CITY 2T / 4T	50	2007 →	FMD0097	R
DELIVERY / EXPRESS	50	2004 → 2012	FMD0097	R
EXPRESS	50	2017 → 2018	FMD0097	R
F409 CRUISE	50	2002 → 2005	FMD0097	R
HIGH WHEEL / TRIGGER	50	2002 → 2003	FMD0097	R
HIW'S	50	1999 →	FMD0097	R
KEY WEST 2T	50	2006 → 2015	FMD0097	R
AKROS / HIW'S	90	1999 →	FMD0097	R
202 T / 303 R	125	1999 →	FMD0097	R
303 REVOLUTION	125	2002 → 2003	FMD0097	R
309 RS	125	2000 →	FMD0097	R
EXPRESS	125	2017 → 2018	FMD0097	R
F409 CRUISE	125	2002 → 2005	FMD0097	R
303 R / 309 RS	150	2000 →	FMD0097	R

TM

all models	125	→ 1985	FMD0029	R
GS- MC	125	1990 → 1992	FMD0029	R

TORROT

MUVI CITY EDITION / EXECUTIVE	2016 → 2017			FMD0097	R
MUVI BUSINESS	2019 →			FMD0097	R

TRIUMPH

BABY SPEED	600	2001 → 2002			FMD0014	R
DAYTONA	600	2003 → 2007			FMD0014	R
SPEED FOUR	600	2003 → 2006			FMD0014	R
TT	600	2000 → 2003			FMD0014	R
DAYTONA	675	2006 → 2012			FMD0014	R
DAYTONA R	675	2011 → 2012			FMD0014	R
STREET TRIPLE	675	2007 → 2012			FMD0014	R
STREET TRIPLE R	675	2009 → 2012			FMD0014	R
TRIDENT	749	1991 → 1998			FMD0176	R
(TRIDENT) SPRINT 749 Up to 9082	749	1993 →			FMD0176	R
DAYTONA	750	1991 → 1992			FMD0176	R
BONNEVILLE AMERICA (carb)	790	2002 → 2004			FMD0449	R
SPEEDMASTER (carb)	790	2003 → 2004			FMD0449	R
AMERICA (carb)	865	2005 → 2011			FMD0449	R
AMERICA EFI	865	2012 → 2015			FMD0449	R
SPEEDMASTER (carb)	865	2005 → 2010			FMD0449	R
SPEEDMASTER EFI	865	2011 → 2015			FMD0449	R
ADVENTURER	885	1996 → 2001			FMD0449	R
LEGEND TT	885	1999 → 2001			FMD0449	R
SPEED TRIPLE (carb)	885	1994 → 1996			FMD0176	R
THUNDERBIRD	885	1995 → 2003			FMD0449	R
THUNDERBIRD SPORT	885	1996 → 2004			FMD0449	R
DAYTONA 885	900	1993 → 1996			FMD0176	R
DAYTONA 900 SUPER 3 750	900	1994 → 1996			FMD0176	R
SPEED TRIPLE T509	900	1997 → 1998			FMD0014	R
SPRINT 885	900	1994 → 1997			FMD0176	R
SPRINT SPORT 885	900	1997 → 1998			FMD0176	R
SPRINT EXECUTIVE 885	900	1998 → 1998			FMD0176	R
TIGER	900	1993 → 1998	FMD0010 (x2)	R		
TRIDENT 885	900	1991 → 1998			FMD0176	R
TROPHY 885	900	1991 → 2001			FMD0176	R
DAYTONA T595	950	1996 → 1998			FMD0014	R
DAYTONA T955i	955	1999 → 2001			FMD0014	R
DAYTONA T955i	955	2002 → 2006	FMD0146 (x2)	RX	FMD0014	R
SPEED TRIPLE T955	955	1999 → 2001			FMD0014	R
SPEED TRIPLE T955	955	2002 → 2005	FMD0146 (x2)	RX	FMD0014	R
T955 DAYTONA	955	1999 → 2001			FMD0014	R
T955 DAYTONA	955	2002 →	FMD0146 (x2)	RX	FMD0014	R
DAYTONA 998	1000	1991 → 1992			FMD0176	R
SPEED TRIPLE ST	1050	2005 → 2006			FMD0014	R
SPEED TRIPLE	1050	2005 → 2010			FMD0014	R
SPRINT ST T1050	1050	2005 → 2008	FMD0146 (x2)	RX		

TRIUMPH

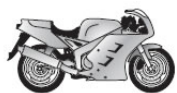

DISCS TYPE



DISCS TYPE

...TRIUMPH

DAYTONA 1180	1200	1993 → 1997			FMD0176	R
TROPHY 1180	1200	1991 → 2003			FMD0176	R
ROCKET III CLASSIC	2300	2004 → 2015	FMD0146 (x2)	RX		
ROCKET III ROADSTER ABS	2300	2010 → 2017	FMD0146 (x2)	RX		

VERTIGO

COMBAT CAMO	300	2015 →	FMD0332	R	FMD0378	R
COMBAT ICE HELL	300	2015 →	FMD0332	R	FMD0378	R

VICTORY

BOARDWALK ABS	1731	2015 → 2016	FMD0121	RX		
CROSS COUNTRY ABS	1731	2015 → 2016	FMD0121 (x2)	RX		
CROSS COUNTRY TOUR ABS	1731	2015 → 2016	FMD0121 (x2)	RX		
GUNNER ABS	1731	2015 → 2016	FMD0121	RX		
HAMMER 8-BALL	1731	2015 → 2016	FMD0121 (x2)	RX		
HAMMER S	1731	2015 → 2016	FMD0121 (x2)	RX		
HIGH-BALL ABS	1731	2015 → 2016	FMD0121	RX		
JUDGE ABS	1731	2015 → 2016	FMD0121	RX		
MAGNUM ABS	1731	2015 → 2016	FMD0121 (x2)	RX		
VEGAS	1731	2015 → 2016	FMD0121	RX		
VISION TOUR ABS	1731	2015 → 2016	FMD0121 (x2)	RX		

VILLA

AX	50	1993 →	FMD0001	R		
GZ	50	1993 →	FMD0001	R		

VOR

EN	400	2000 → 2002			FMD0164	R
SMR C	400	2000 → 2002			FMD0164	R
EN	450	2002 →			FMD0164	R
SMC	450	2002 →			FMD0164	R
SMR C	450	2002 →			FMD0164	R
EN	492	1998 → 2001			FMD0164	R
EN	495	1998 → 2001			FMD0164	R
MSM	495	1998 → 2001			FMD0164	R
Cross	500	1998 → 2002			FMD0164	R
Enduro	500	1998 → 2002			FMD0164	R
SM	500	1999 →			FMD0164	R
MX EX	503	2000 → 2002	FMD0182	R	FMD0164	R
EN	530	2002 →			FMD0164	R
MSME	530	2002 →			FMD0164	R
SMR C	530	2002 →			FMD0164	R

VOXAN

BLACK MAGIC	995	2006 → 2008	FMD0111 (x2)	RX	FMD0023	R
CAFE RACER	995	2000 → 2006	FMD0111 (x2)	RX	FMD0023	R
ROADSTER	995	2001 → 2006	FMD0111 (x2)	RX	FMD0023	R
BOXER	1000	2000 →			FMD0023	R
CYCLOPE	1000	2002 →			FMD0023	R
SCRAMBLER	1000	2006 →			FMD0023	R
STREET SCRAMBLER	1000	2000 → 2008			FMD0023	R
VB1 EVO	1000	2003 → 2004			FMD0023	R

YAMAHA

AEROX YQ 50 2T	50	1997 → 2017	FMD0097	R	FMD0097	R
AEROX R 2T	50	2018 → 2018	FMD0097	R	FMD0097	R
AEROX 4 4T	50	2018 → 2018	FMD0097	R	FMD0097	R
AEROX R 4T ST	50	2019 →	FMD0097	R	FMD0097	R
AXIS YA	50	1993 →	FMD0001	R		
BREEZE YM	50	1994 → 1996	FMD0001	R		
YM BREEZE (Rear Drum Model)	50	1994 → 1998	FMD0001	R		
BW S R	50	1995 → 1996	FMD0001	R		
BW S	50	1997 →	FMD0001	R		
CR Z	50	1992 →	FMD0001	R		
JOG (ITALIA)	50	1991 → 1996	FMD0001	R		
JOG R	50	2002 → 2011	FMD0097	R		
JOG R (Rear Drum Model)	50	2002 → 2011	FMD0097	R		
NEO'S	50	1997 → 2006	FMD0002	R		

TRIUMPH

10038

FERODO

RACING

Updated on November 2020



DISCS TYPE



DISCS TYPE

...YAMAHA

NEO'S	50	2007 → 2018	FMD0097	R		
NEO'S 4	50	2009 → 2018	FMD0097	R		
NEO'S 4T	50	2019 →	FMD0097	R		
SLIDER	50	1999 →	FMD0097	R	FMD0097	R
TZR R	50	1993 → 2002	FMD0030	R		
TZR	50	1996 → 2002	FMD0175	R	FMD0325	R
YH 50 WHY	50	1999 → 2007	FMD0217	R		
TZR	80	1996 → 1998	FMD0175	R		
JOG	90	1990 →	FMD0001	R		
AEROX YQ 100	100	2000 → 2002	FMD0097	R		
BW S	100	1999 → 2001	FMD0363	R		
NEO'S	100	2000 → 2002	FMD0002	R		
CYGNUS R XC K	125	1997 → 1998	FMD0363	R		
CYGNUS R XC	125	1999 → 2003	FMD0363	R		
CYGNUS X NXC	125	2004 → 2006	FMD0397	R		
CYGNUS XC	125	2007 →	FMD0474	R		
CYGNUS X	125	2008 → 2017	FMD0474	R		
XVS DRAG STAR (Rear Drum Model)	125	1999 → 2004	FMD0163	RF/R		
XVS DRAG STAR	125	1999 → 2001	FMD0163	RF/R		
DT R	125	1988 → 2003	FMD0029	R	FMD0182	R
DT-Z TENERE	125	1989 → 1990	FMD0029	R		
MAJESTY YP	125	1998 → 2000	FMD0110	R		
MAJESTY YP E	125	2001 → 2009	FMD0110	R	FMD0156	R
YP MAJESTY	125	1998 → 2009	FMD0110	R		
MAXSTER XQ	125	2001 → 2002			FMD0170	R
SR	125	1997 → 2002	FMD0155	R		
TDR (Japanese model)	125	1989 →	FMD0163	RF/R		
TDR	125	1989 → 2001	FMD0111	RX	FMD0182	R
TEO'S XN	125	1999 → 2002	FMD0110	R		
TZR	125	1987 → 1995	FMD0175	R		
TZR R	125	1991 → 1995	FMD0175	R		
TZR RED ROCKET	125	1993 → 1995	FMD0175	R		
TZ COMPETITION	125	1996 → 1997	FMD0121	RX		
XV VIRAGO (Rear Drum Model)	125	1997 → 2001	FMD0163	RF/R		
XVS VIRAGO	125	1998 → 2000	FMD0163	RF/R		
XV VIRAGO	125	1997 → 2000	FMD0163	RF/R		
WR	125	1989 → 1990	FMD0029	R	FMD0182	R
WR	125	1991 → 1997	FMD0037	R	FMD0182	R
WR	125	1998 → 2000	FMD0157	R	FMD0258	R
WR	125	2001 → 2002	FMD0028	RF/MXR	FMD0258	R
WR	125	2002 → 2005	FMD0028	RF/MXR	FMD0263	MXR
X-CITY VP	125	2008 → 2011	FMD0424	R	FMD0320	R
X-MAX YP R	125	2006 → 2009	FMD0437	RF/R	FMD0320	R
X-MAX YP R	125	2010 → 2013	FMD0437	RF/R	FMD0320	R
X-MAX ABS YP RA 125	125	2011 → 2013	FMD0437	RF/R	FMD0445	R
X-MAX ABS YP RA 125	125	2014 → 2017	FMD0367	R	FMD0445	R
X-MAX ABS YP RA 125	125	2018 → 2019	FMD0367	R		
XENTER (Rear Drum Model)	125	2012 → 2016	FMD0454	R		
YZ	125	1985 → 1989	FMD0029	R	FMD0182	R
YZ	125	1990 → 1997	FMD0037	R	FMD0182	R
YZ	125	1998 → 2001	FMD0157	R	FMD0258	R
YZ	125	2008 → 2016	FMD0457	MXR	FMD0263	MXR
YZ	125	2017 →	FMD0462	MXR	FMD0263	MXR
YZ	125	2002 → 2007	FMD0028	RF/MXR	FMD0263	MXR
FLY ONE R XC	150	1998 →	FMD0363	R		
MAJESTY YP	150	→ 2000	FMD0110	R		
MAJESTY YP E	150	→ 2002	FMD0110	R		
MAJESTY YP	150	2001 → 2002	FMD0110	R	FMD0156	R
MAXSTER XQ	150	2001 → 2002			FMD0170	R
TEOS XN	150	2001 → 2002	FMD0023	R		
XENTER (Rear Drum Model)	150	2012 → 2016	FMD0454	R		
MAJESTY YP E	180	2003 → 2006	FMD0110	R	FMD0156	R
DT R	200	1988 → 1991	FMD0029	R		
SR	200	1997 →	FMD0422	RF		
WR R	200	1992 → 1995			FMD0182	R
XVS DRAG STAR	250	2001 →	FMD0163	RF/R		
FZX ZEAL	250	1991 → 1992	FMD0111	RX		
MAJESTY YP	250	1996 → 1998	FMD0023	R		
MAJESTY DX YP	250	1998 → 1999	FMD0023	R		
MAJESTY YP	250	2000 → 2003	FMD0023	R	FMD0173	R
YP 250 MAJESTY	250	2001 →			FMD0173	R
MAJESTY ABS YP	250	2003 →	FMD0023	R	FMD0173	R
R1-Z	250	1997 →	FMD0121 (x2)	RX		
SRV S -RENAISSA	250	1992 → 2000	FMD0163	RF/R		
SRV (Rear Drum Model)	250	1992 → 1997	FMD0163	RF/R		
TDR	250	1988 → 1992	FMD0111	RX		



DISCS TYPE



DISCS TYPE

...YAMAHA

TT R	250	1993 →				FMD0182	R
TZ GP	250	1996 → 1997	FMD0121 (x2)	RX			
TZR	250	1989 → 1992	FMD0111 (x2)	RX			
XV VIRAGO	250	1995 → 2007	FMD0163	RF/R			
VP 250 X-CITY	250	2007 → 2008	FMD0424	R			
WR	250	1990 → 1991				FMD0182	R
WR Z	250	1991 → 1997	FMD0037	R			
WR	250	1992 → 1997	FMD0157	R		FMD0182	R
WR	250	1998 → 2000	FMD0157	R		FMD0258	R
WR	250	2001 → 2008	FMD0028	RF/MXR		FMD0263	MXR
WR F	250	2001 → 2001	FMD0028	RF/MXR		FMD0258	R
WR F	250	2002 → 2013	FMD0028	RF/MXR		FMD0263	MXR
WR X	250	2008 →	FMD0126	RX			
WR F EFI	250	2015 →	FMD0028	RF/MXR		FMD0263	MXR
X-CITY VP	250	2007 → 2014	FMD0424	R		FMD0320	R
X-MAX YP R	250	2005 → 2013	FMD0437	RF/R		FMD0320	R
X-MAX YP R SPORT	250	2011 → 2012	FMD0437	RF/R		FMD0320	R
X-MAX YP RA ABS	250	2011 → 2013	FMD0437	RF/R		FMD0445	R
X-MAX YP RA ABS	250	2014 → 2016	FMD0367	R		FMD0445	R
X-MAX YP R IRON MAX ABS	250	2016 → 2016	FMD0367	R			
XVS DRAG STAR (Rear Drum Model)	250	2001 → 2004	FMD0163	RF/R			
YP G GRAND MAJESTY [japan]	250	2004 → 2005	FMD0367	R			
YZ	250	1985 → 1990	FMD0029	R		FMD0182	R
YZ	250	1990 → 1997	FMD0037	R		FMD0182	R
YZ	250	1998 → 2000	FMD0157	R		FMD0258	R
YZ	250	2001 → 2002	FMD0028	RF/MXR		FMD0258	R
YZ F	250	2001 → 2001	FMD0028	RF/MXR		FMD0258	R
YZ	250	2002 → 2007	FMD0028	RF/MXR		FMD0263	MXR
YZ F	250	2002 → 2006	FMD0028	RF/MXR		FMD0263	MXR
YZ F	250	2007 → 2015	FMD0457	MXR		FMD0263	MXR
YZ	250	2008 → 2016	FMD0457	MXR		FMD0263	MXR
YZ F EFI	250	2014 → 2015	FMD0028	RF/MXR		FMD0263	MXR
YZ F	250	2016 →	FMD0462	MXR		FMD0263	MXR
YZ FX	250	2016 →	FMD0462	MXR		FMD0263	MXR
YZ X	250	2016 →	FMD0462	MXR		FMD0263	MXR
YZ- WR	250	1998 →	FMD0028	RF/MXR		FMD0258	R
VERSITY XC	300	2003 → 2006	FMD0319	R		FMD0320	R
X-MAX (SH08 - CDZ)	300	2017 →	FMD0367	R			
X-MAX Iron Max (CDZ)	300	2019 →	FMD0367	R			
MT03 ABS	320	2016 → 2018	FMD0139	RX			
YZF R3	320	2015 → 2018	FMD0139	RX			
RD LC	350	1983 → 1993	FMD0155 (x2)	R		FMD0155	R
RD YPVS	350	1983 → 1984	FMD0422	RF			
RD F / N / R	350	1985 → 1993	FMD0422	RF			
TT	350	1985 → 1995	FMD0029	R			
XT	350	1985 → 1990	FMD0037	R			
YZ	360	1989 →	FMD0037	R		FMD0182	R
YZ RALLY	360	1990 → 1993	FMD0037	R		FMD0182	R
FZ N	400	1985 →	FMD0422	RF			
YP MAJESTY ABS	400	2007 → 2011	FMD0437 (x2)	RF/R		FMD0444	R
SR (Rear Drum Model)	400	2014 → 2015	FMD0275	RF			
SRX	400	1991 →	FMD0111	RX		FMD0023	R
WR F	400	1998 → 2000	FMD0157	R		FMD0182	R
WR F	400	2001 → 2002	FMD0028	RF/MXR		FMD0263	MXR
X-MAX YP	400	2013 → 2019	FMD0437 (x2)	RF/R		FMD0444	R
X-MAX YP ABS	400	2014 → 2019	FMD0437 (x2)	RF/R		FMD0444	R
X-MAX ABS MOMODESIGN 400 YP RA	400	2014 → 2016	FMD0437 (x2)	RF/R		FMD0444	R
X-MAX MOMODESIGN 400 YP R	400	2014 → 2016	FMD0437 (x2)	RF/R		FMD0444	R
X-MAX 400 RA IRON MAX ABS	400	2016 → 2019	FMD0437 (x2)	RF/R		FMD0444	R
X-MAX SPORT	400	2017 → 2018	FMD0437 (x2)	RF/R		FMD0444	R
XJR	400	1995 → 2000	FMD0121 (x2)	RX		FMD0023	R
XS	400	1982 →	FMD0422	RF			
YP MAJESTY	400	2004 → 2011	FMD0437 (x2)	RF/R		FMD0444	R
YZ-F	400	1998 → 2000	FMD0157	R		FMD0258	R
WR F	426	2000 → 2000	FMD0157	R		FMD0258	R
WR F	426	2001 → 2002	FMD0028	RF/MXR		FMD0258	R
YZ-F	426	2000 → 2000	FMD0157	R		FMD0258	R
YZ-F	426	2001 → 2002	FMD0028	RF/MXR		FMD0263	MXR
WR F	450	2003 → 2015	FMD0028	RF/MXR		FMD0263	MXR
WR F	450	2016 →	FMD0462	MXR		FMD0263	MXR
YZ-F	450	2003 → 2007	FMD0028	RF/MXR		FMD0263	MXR
YZ-F	450	2008 → 2015	FMD0457	MXR		FMD0263	MXR
YZ-F	450	2016 →	FMD0462	MXR		FMD0263	MXR
RD LC	500	1984 → 1988	FMD0422 (x2)	RF		FMD0257	R
T MAX XP	500	2001 → 2003	FMD0163	RF/R		FMD0155	R
T MAX XP	500	2004 → 2007	FMD0437 (x2)	RF/R		FMD0155	R

YAMAHA

10040



DISCS TYPE



DISCS TYPE

...YAMAHA

T MAX ABS XP	500	2005 → 2007	FMD0437 (x2)	RF/R	FMD0155	R
T MAX ABS XP	500	2008 → 2011	FMD0422 (x2)	RF	FMD0155	R
T MAX XP	500	2008 → 2011	FMD0422 (x2)	RF	FMD0155	R
T MAX SV ABS XP	500	2011 → 2011	FMD0422 (x2)	RF	FMD0155	R
T MAX SV XP	500	2011 → 2011	FMD0422 (x2)	RF	FMD0155	R
WR Z	500	1992 → 1993	FMD0029	R	FMD0182	R
T MAX IRON MAX	530	2014 → 2017	FMD0437 (x2)	RF/R	FMD0451	R
T MAX LUX MAX ABS	530	2016 → 2017	FMD0437 (x2)	RF/R	FMD0451	R
T MAX SX SPORT EDITION ABS	530	2018 → 2019	FMD0437 (x2)	RF/R	FMD0451	R
T MAX XP	530	2012 → 2019	FMD0437 (x2)	RF/R	FMD0451	R
T MAX XP ABS	530	2012 → 2019	FMD0437 (x2)	RF/R	FMD0451	R
T MAX XP DX ABS	530	2017 → 2019	FMD0437 (x2)	RF/R	FMD0451	R
T MAX XP SX ABS	530	2017 → 2019	FMD0437 (x2)	RF/R	FMD0451	R
XVS VIRAGO (Rear Drum Model)	535	1996 → 2000	FMD0275	RF		
XZ	550	1982 → 1984	FMD0422	RF		
XVS DRAG STAR	600	1997 →	FMD0275	RF		
FZ	600	1987 → 1988	FMD0422	RF		
FZ6 FAZER	600	2004 → 2007	FMD0139 (x2)	RX	FMD0405	R
FZ6	600	2004 → 2008	FMD0139 (x2)	RX		
FZ6 S2	600	2007 → 2008	FMD0139 (x2)	RX	FMD0405	R
FZ6 FAZER S2	600	2007 → 2009	FMD0139 (x2)	RX	FMD0405	R
FZ6 FAZER	600	2008 → 2008	FMD0139 (x2)	RX		
FZ6 S2	600	2009 → 2009			FMD0405	R
FZR R	600	1990 → 1995	FMD0121 (x2)	RX	FMD0023	R
FZR	600	1989 →	FMD0121 (x2)	RX	FMD0023	R
FZS FAZER	600	1998 → 2003	FMD0121 (x2)	RX	FMD0023	R
SRX	600	1985 → 1987	FMD0422 (x2)	RF	FMD0023	R
SRX	600	1988 → 1989			FMD0023	R
XT Z TENERE	600	1986 → 1986	FMD0155	R		
XT Z TENERE	600	1987 → 1991	FMD0155	R	FMD0256	R
TT N	600	1985 → 1988	FMD0029	R		
TT	600	1989 → 1992	FMD0029	R		
TT E	600	1993 → 2001	FMD0159	R		
TT K	600	1993 → 1996	FMD0159	R		
TT	600	1996 → 2001			FMD0182	R
TT R	600	2003 → 2007			FMD0182	R
TT R E	600	2004 → 2007	FMD0159	R		
TT	600	1993 → 1995	FMD0159	R	FMD0182	R
TT R	600	1998 → 2002	FMD0159	R	FMD0182	R
XJ6 DIVERSION	600	1983 → 1991	FMD0422	RF		
XJ N	600	1991 → 1997	FMD0160	R	FMD0023	R
XJ S DIVERSION	600	1991 → 1997	FMD0160	R	FMD0023	R
XJ N	600	1998 → 2003	FMD0126 (x2)	RX	FMD0023	R
XJ S DIVERSION	600	1998 → 2003	FMD0126	RX	FMD0023	R
XJ6	600	2009 → 2012	FMD0139 (x2)	RX		
XJ6 DIVERSION	600	2009 → 2015	FMD0139 (x2)	RX		
XJ DIVERSION S-N	600	1991 → 1997	FMD0160	R	FMD0023	R
XJ	600	1983 → 1991	FMD0155 (x2)	R	FMD0155	R
XJ DIVERSION S-N	600	1998 →	FMD0126 (x2)	RX	FMD0023	R
XJ6 DIVERSION F	600	2010 → 2012	FMD0139 (x2)	RX		
XJ6 ABS	600	2013 → 2015	FMD0139 (x2)	RX		
XJ6 DIVERSION ABS	600	2013 → 2015	FMD0139 (x2)	RX		
XT 4 VALVES	600	1986 → 1987	FMD0155	R		
XT	600	1987 → 1990	FMD0155	R	FMD0256	R
XT 4 VALVES	600	1988 → 1989	FMD0155	R	FMD0256	R
XT E	600	1990 → 1994	FMD0155	R	FMD0256	R
XT E	600	1995 → 1996	FMD0175	R	FMD0256	R
XT E	600	1997 → 2003			FMD0256	R
YX RADIAN	600	1986 → 1990	FMD0422	RF		
YZF R THUNDERCAT	600	1996 → 2004	FMD0126 (x2)	RX	FMD0023	R
YZF R6	600	2005 → 2016	FMD0394 (x2)	RX	FMD0265	R
YZF R6	600	2017 →	FMD0281 (x2)	RX		
YZF R6	600	1999 → 2002	FMD0126 (x2)	RX	FMD0261	R
YZF R6	600	2003 → 2004	FMD0139 (x2)	RX	FMD0265	R
XVS DRAG STAR (Rear Drum Model)	650	1997 → 2004	FMD0275	RF		
XVS DRAG STAR CLASSIC (Rear Drum Model)	650	1998 → 2007	FMD0275	RF		
XJ SEKA / XJ TURBO	650	1982 → 1983	FMD0422	RF		
MT-03	660	2006 → 2012	FMD0139 (x2)	RX	FMD0405	R
SZR	660	1995 → 2001	FMD0111	RX		
XTZ TENERE	660	1992 → 1998			FMD0256	R
XTZ TENERE	660	1991 → 1991	FMD0175	R	FMD0256	R
Tracer 700	689	2016 →			FMD0470	R
Tracer 700 ABS	689	2018 →			FMD0470	R
Tracer 700 GT	689	2018 →			FMD0470	R
FZX	700	1986 → 1987	FMD0422	RF		
MT-07	700	2013 →			FMD0470	R

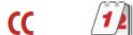

DISCS TYPE



DISCS TYPE

...YAMAHA

MT-07 Motocage ABS	700	2015	→				FMD0470	R
MT-07 Sport	700	2017	→				FMD0470	R
XSR 700 Xtribute	700	2019	→				FMD0470	R
FZ GENESIS	750	1987	→ 1988	FMD0422 (x2)	RF		FMD0155	R
FZ GENESIS	750	1989	→ 1992	FMD0121 (x2)	RX		FMD0155	R
FZR R	750	1989	→ 1992	FMD0111 (x2)	RX			
FZX FAZER	750	1986	→ 1990	FMD0422 (x2)	RF		FMD0155	R
XV VIRAGO	750	1987	→ 1993	FMD0155 (x2)	R			
XV VIRAGO	750	1994	→ 2000	FMD0175 (x2)	R			
XTZ SUPER TENERE	750	1989	→ 2000	FMD0030 (x2)	R		FMD0257	R
YZF SP	750	1993	→ 1997	FMD0352 (x2)	RX		FMD0023	R
YZF R7	750	1999	→ 2001	FMD0129 (x2)	RX		FMD0023	R
YZF R	750	1993	→ 1997	FMD0352 (x2)	RX		FMD0023	R
FAZER 8	800	2010	→ 2012	FMD0394 (x2)	RX		FMD0367	R
FAZER 8	800	2013	→ 2015	FMD0394 (x2)	RX			
FZ8 N 800	800	2010	→ 2010	FMD0394 (x2)	RX			
FZ8 N 800	800	2011	→ 2015	FMD0394 (x2)	RX		FMD0367	R
FZ8 NA 800	800	2011	→ 2012	FMD0394 (x2)	RX		FMD0367	R
FZ8 S FAZER 800	800	2011	→	FMD0394 (x2)	RX		FMD0367	R
FZ8 SA FAZER 800	800	2011	→	FMD0394 (x2)	RX		FMD0367	R
FZ8 NA 800	800	2013	→ 2015	FMD0394 (x2)	RX			
TRACER 900 GT	847	2018	→ 2019	FMD0139 (x2)	RX		FMD0470	R
MT-09A TRACER	850	2015	→ 2019	FMD0139 (x2)	RX		FMD0470	R
MT-09 SP ABS	850	2018	→ 2019	FMD0139 (x2)	RX		FMD0470	R
MT-09	850	2014	→ 2019	FMD0139 (x2)	RX		FMD0470	R
MT-09 ABS	850	2014	→ 2019	FMD0139 (x2)	RX		FMD0470	R
MT-09 SPORT TRACKER ABS	850	2016	→ 2016	FMD0139 (x2)	RX		FMD0470	R
MT-09 STREET RALLY ABS	850	2014	→ 2016	FMD0139 (x2)	RX		FMD0470	R
TDM	850	1991	→ 2001	FMD0121 (x2)	RX		FMD0023	R
TRX	850	1995	→ 2000	FMD0121 (x2)	RX		FMD0023	R
XSR 900	850	2016	→ 2019	FMD0139 (x2)	RX		FMD0470	R
XSR 900 ABS	850	2016	→ 2019	FMD0139 (x2)	RX		FMD0470	R
XSR 900 ABARTH ABS	850	2017	→ 2019	FMD0139 (x2)	RX		FMD0470	R
TDM	900	2002	→ 2014	FMD0126 (x2)	RX		FMD0023	R
XJ	900	1987	→ 1994	FMD0422	RF			
XJ S DIVERSION	900	1994	→ 1996				FMD0155	R
SCR	950	2017	→	FMD0126	RX			
XV	950	2014	→ 2015	FMD0126	RX			
XV ABS	950	2014	→ 2016	FMD0126	RX			
XV R ABS	950	2014	→ 2017	FMD0126	RX			
XV RACER ABS	950	2015	→ 2017	FMD0126	RX			
XVS A MIDNIGHT STAR	950	2009	→ 2013	FMD0129 (x2)	RX			
FZ1 FAZER	1000	2006	→ 2012	FMD0281 (x2)	RX		FMD0405	R
FZ1	1000	2006	→ 2012	FMD0281 (x2)	RX		FMD0405	R
FZ1 FAZER ABS	1000	2007	→ 2012	FMD0281 (x2)	RX		FMD0405	R
FZ1	1000	2013	→ 2014	FMD0281 (x2)	RX			
FZR GENESIS	1000	1987	→ 1989	FMD0111 (x2)	RX		FMD0155	R
FZR EXUP	1000	1990	→ 1995	FMD0111 (x2)	RX		FMD0155	R
FZS FAZER	1000	2001	→ 2005	FMD0126 (x2)	RX		FMD0155	R
GTS / GTS A	1000	1993	→ 1999				FMD0163	RF/R
MT-10 ABS	1000	2016	→ 2017	FMD0281 (x2)	RX			
MT-10 SP ABS	1000	2017	→	FMD0281 (x2)	RX			
XV / XV SE VIRAGO	1000	1986	→	FMD0422	RF			
YZF R1	1000	2004	→ 2006	FMD0281 (x2)	RX		FMD0265	R
YZF R1	1000	2007	→ 2014	FMD0394 (x2)	RX		FMD0265	R
YZF R1	1000	2015	→ 2017	FMD0281 (x2)	RX			
YZF R1M	1000	2015	→ 2017	FMD0281 (x2)	RX			
YZF R1 60TH ANNIVERSARY EDITION	1000	2016	→	FMD0281 (x2)	RX			
YZF R THUNDERACE	1000	1996	→ 1998	FMD0126 (x2)	RX		FMD0023	R
YZF R1	1000	1998	→ 2001	FMD0126 (x2)	RX		FMD0023	R
YZF R1	1000	2002	→ 2003	FMD0126 (x2)	RX		FMD0261	R
BT BULLDOG	1100	2002	→ 2006	FMD0126 (x2)	RX		FMD0155	R
XVS DRAG STAR	1100	1999	→ 2006	FMD0275 (x2)	RF		FMD0163	RF/R
FJ	1100	1984	→ 1987	FMD0163	RF/R		FMD0163	RF/R
XV VIRAGO (Rear Drum Model)	1100	1986	→ 1993	FMD0422 (x2)	RF			
FJ	1200	1986	→ 1987	FMD0163	RF/R		FMD0163	RF/R
FJ	1200	1988	→ 1991	FMD0121	RX		FMD0163	RF/R
FJ	1200	1992	→ 1995				FMD0163	RF/R
FJ ABS	1200	1991	→ 1991	FMD0121	RX		FMD0163	RF/R
FJ ABS	1200	1992	→ 1993				FMD0163	RF/R
V MAX	1200	1986	→ 1992	FMD0163 (x2)	RF/R		FMD0163	RF/R
V MAX	1200	1993	→ 2006	FMD0275	RF		FMD0163	RF/R
XJR	1200	1995	→ 1996	FMD0111 (x2)	RX		FMD0155	R
XJR	1200	1997	→	FMD0111 (x2)	RX		FMD0155	R
XT Z SUPER TENERE	1200	2010	→ 2019	FMD0394 (x2)	RX			
XT ZE SUPER TENERE	1200	2014	→ 2019	FMD0394 (x2)	RX			

YAMAHA

10042

FERODO

RACING

Updated on November 2020



CC



DISCS TYPE



DISCS TYPE

...YAMAHA

XT Z SUPER TENERE WORLDCROSSER	1200	2016 →	FMD0394 (x2)	RX		
XVZ VENTURE ROYALE	1200	1984 → 1987	FMD0126 (x2)	RX	FMD0126	RX
FJR A	1300	2013 → 2015	FMD0126 (x2)	RX	FMD0163	RF/R
FJR AE	1300	2014 → 2017	FMD0129 (x2)	RX	FMD0163	RF/R
FJR AS	1300	2015 → 2017	FMD0129 (x2)	RX	FMD0163	RF/R
FJR	1300	2001 → 2004	FMD0126 (x2)	RX	FMD0163	RF/R
FJR ABS	1300	2003 → 2017	FMD0129 (x2)	RX	FMD0163	RF/R
XJR	1300	1998 → 1998	FMD0111 (x2)	RX	FMD0155	R
XJR RACER	1300	2016 → 2017	FMD0126 (x2)	RX		
XJR	1300	1999 → 2015	FMD0126 (x2)	RX	FMD0155	R
XJR	1300	2016 → 2017	FMD0126 (x2)	RX		
XVS MIDNIGHT STAR	1300	2007 → 2016	FMD0126 (x2)	RX		
XVS CU CUSTOM	1300	2014 → 2016	FMD0126	RX		
XVZ 13 T-TD VENTURE ROYALE	1300	1988 → 1995	FMD0163 (x2)	RF/R		
XVZ TF ROYAL STAR VENTURE	1300	1996 → 2007	FMD0275 (x2)	RF	FMD0160	R
XVZ13TF WILD STAR	1300	1999 →	FMD0275 (x2)	RF	FMD0160	R
XVS WILD STAR	1600	1999 → 2007	FMD0275 (x2)	RF		
XVS ROAD STAR	1600	1999 → 2007	FMD0275 (x2)	RF		
MT-01	1670	2005 → 2006	FMD0129 (x2)	RX	FMD0155	R
MT-01	1670	2007 →			FMD0155	R
V MAX	1700	2009 → 2016	FMD0281 (x2)	RX		
XV PC ROAD STAR WARRIOR	1700	2002 → 2007	FMD0126 (x2)	RX		
XV-Y	1700	2009 → 2016	FMD0281 (x2)	RX		
XV ROADLINER	1900	2006 →	FMD0275	RF		
XV A MIDNIGHT STAR	1900	2013 → 2016	FMD0126 (x2)	RX		
XV A CASUAL FULL DRESS	1900	2016 →	FMD0126 (x2)	RX		



FERODO[®]

DISCS

ATV APPLICATIONS



FERODO[®]

MOTORCYCLE



CC



DISCS TYPE



DISCS TYPE

BOMBARDIERDS X 650 2001 → 2002 **FMD0353 (x2)** R**KYMCO**MXER 50 2003 → **FMD0034 (x2)** R**YAMAHA**YFS BLASTER 200 1988 → 2002 **FMD0274** RYFS R BLASTER 200 2003 → 2006 **FMD0274** RYFM BEAR TRACKER 250 2001 → 2004 **FMD0030 (x2)** RYFZ BANSHEE 350 1987 → 2009 **FMD0274** RYFM RN RAPTOR 660 2001 → 2005 **FMD0274** R

BOMBARDIER

11000



DISC DRAWINGS







DISC TECHNICAL DIMENSIONS

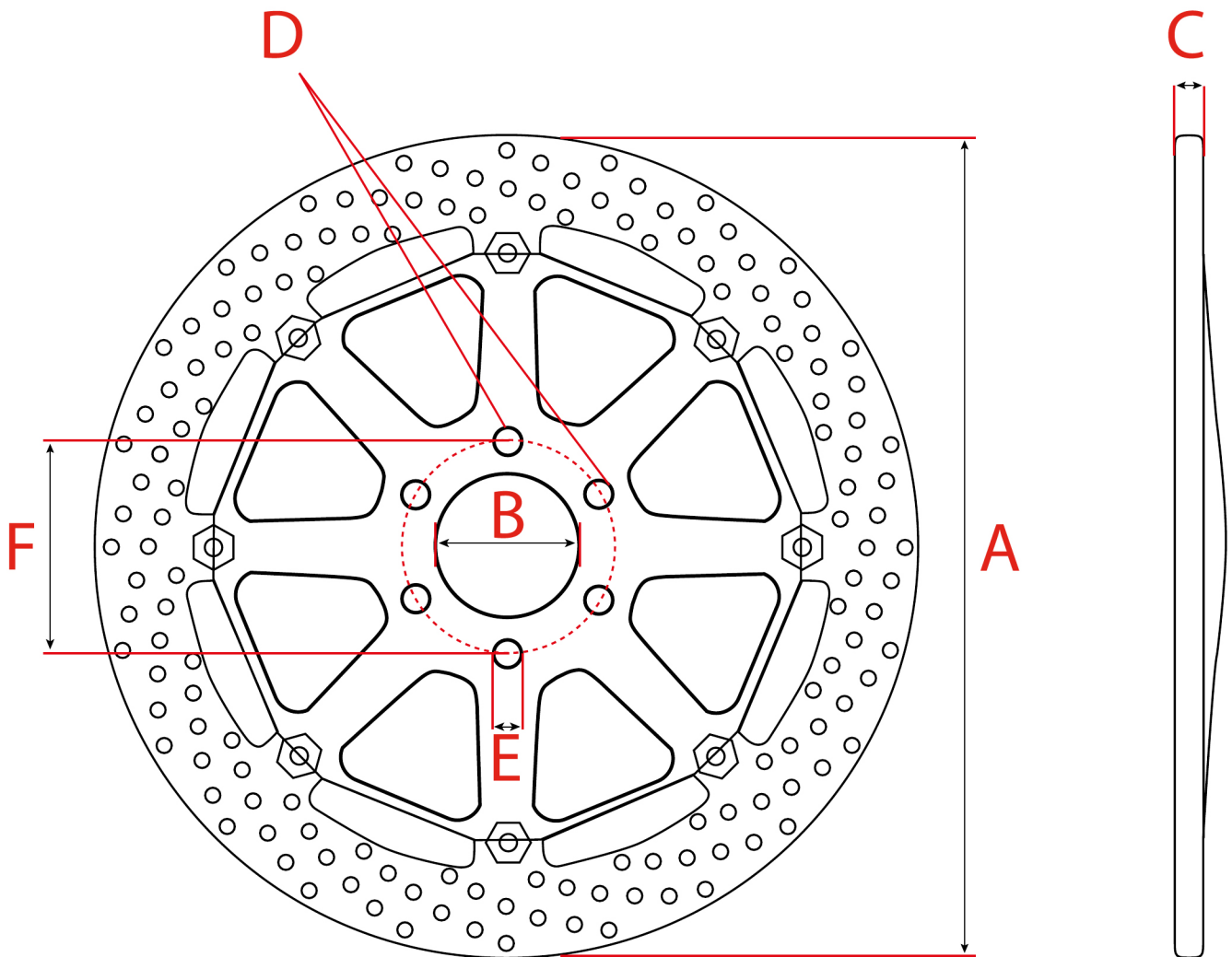

A Outside Diameter (mm)

B Inside Diameter (mm)

C Thickness (mm)

D Fixing Holes (no.)

E Fixing Holes Diameter (mm)

F Fixing Holes Centreline Diameter (mm)

FMD0001R

Available

FRONT

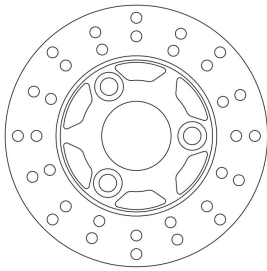
**FMD0002R**

Available

FRONT / REAR

Compressivo Kit viti / with screws kit

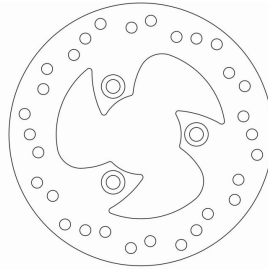
**FMD0003R**

Available

FRONT / REAR

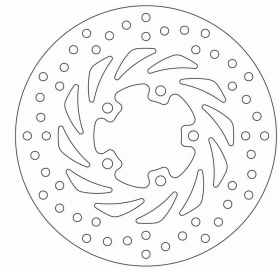
**DIMENSIONS**

A	Outside Diam. mm	155
B	Inside Diam. mm	40.8
C	Thickness mm	4
D	Fixing Holes Number	3
E	Fixing Holes Diam. mm	10.5
F	Fixing Holes Centreline Diam. mm	66

DIMENSIONS

A	Outside Diam. mm	190
B	Inside Diam. mm	58.2
C	Thickness mm	4
D	Fixing Holes Number	3
E	Fixing Holes Diam. mm	10
F	Fixing Holes Centreline Diam. mm	80

DIMENSIONS

A	Outside Diam. mm	220
B	Inside Diam. mm	60
C	Thickness mm	4
D	Fixing Holes Number	5
E	Fixing Holes Diam. mm	8.5
F	Fixing Holes Centreline Diam. mm	80

FMD0005R

Available

REAR

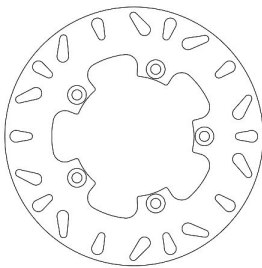
**DIMENSIONS**

A	Outside Diam. mm	220
B	Inside Diam. mm	102.2
C	Thickness mm	5
D	Fixing Holes Number	5
E	Fixing Holes Diam. mm	8.6
F	Fixing Holes Centreline Diam. mm	120

FMD0006R

Available

FRONT

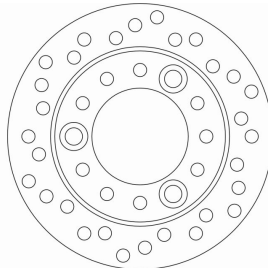
**DIMENSIONS**

A	Outside Diam. mm	157.5
B	Inside Diam. mm	58.2
C	Thickness mm	4
D	Fixing Holes Number	3
E	Fixing Holes Diam. mm	10.5
F	Fixing Holes Centreline Diam. mm	80

FMD0007R

Available

FRONT

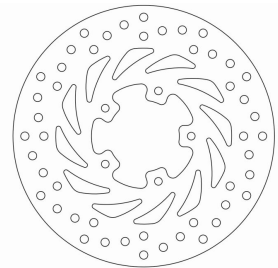
**DIMENSIONS**

A	Outside Diam. mm	220
B	Inside Diam. mm	58.5
C	Thickness mm	4
D	Fixing Holes Number	5
E	Fixing Holes Diam. mm	6.5
F	Fixing Holes Centreline Diam. mm	80

For A,B,C,D,E,F see first page of this section

12000**FERODO**

RACING

Updated on November 2020

FMD0009R

Available

FRONT / REAR

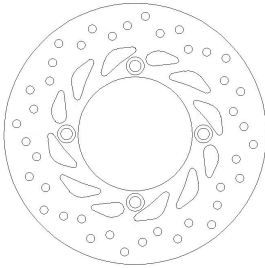
**FMD0010R**

Available

FRONT

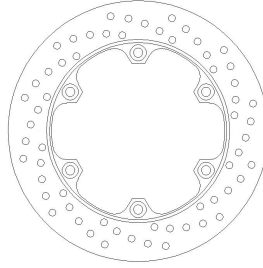
**FMD0011R**

Available

REAR

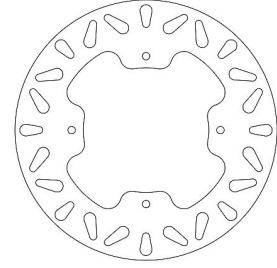
**DIMENSIONS**

A	Outside Diam. mm	240
B	Inside Diam. mm	105.5
C	Thickness mm	5
D	Fixing Holes Number	4
E	Fixing Holes Diam. mm	10.5
F	Fixing Holes Centreline Diam. mm	125

DIMENSIONS

A	Outside Diam. mm	276
B	Inside Diam. mm	144.4
C	Thickness mm	5
D	Fixing Holes Number	6
E	Fixing Holes Diam. mm	10.5
F	Fixing Holes Centreline Diam. mm	166

DIMENSIONS

A	Outside Diam. mm	220
B	Inside Diam. mm	105.5
C	Thickness mm	5
D	Fixing Holes Number	4
E	Fixing Holes Diam. mm	6.3
F	Fixing Holes Centreline Diam. mm	125

FMD0014R

Available

REAR

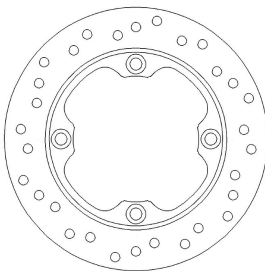
**FMD0015R**

Available

FRONT

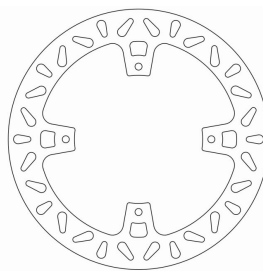
**FMD0017RF**

Available

FRONT

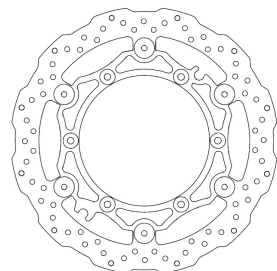
**DIMENSIONS**

A	Outside Diam. mm	220
B	Inside Diam. mm	105.3
C	Thickness mm	5
D	Fixing Holes Number	4
E	Fixing Holes Diam. mm	10.5
F	Fixing Holes Centreline Diam. mm	125

DIMENSIONS

A	Outside Diam. mm	240
B	Inside Diam. mm	118
C	Thickness mm	4
D	Fixing Holes Number	4
E	Fixing Holes Diam. mm	6.5
F	Fixing Holes Centreline Diam. mm	134

DIMENSIONS

A	Outside Diam. mm	260
B	Inside Diam. mm	127
C	Thickness mm	3
D	Fixing Holes Number	6
E	Fixing Holes Diam. mm	6.5
F	Fixing Holes Centreline Diam. mm	143

For A,B,C,D,E,F see first page of this section

FMD0017MXR

Available

FRONT

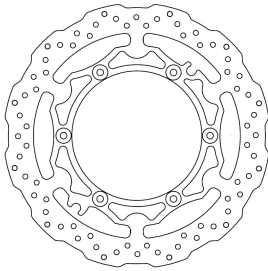
**FMD0018R**

Available

FRONT

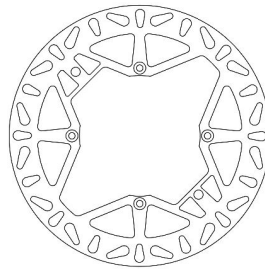
**FMD0019R**

Available

FRONT

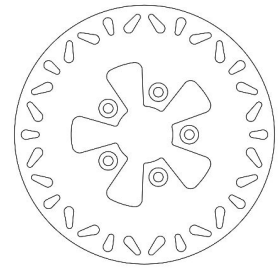
**DIMENSIONS**

A	Outside Diam. mm	260
B	Inside Diam. mm	127
C	Thickness mm	3
D	Fixing Holes Number	6
E	Fixing Holes Diam. mm	6.5
F	Fixing Holes Centreline Diam. mm	143

DIMENSIONS

A	Outside Diam. mm	260
B	Inside Diam. mm	120.2
C	Thickness mm	3
D	Fixing Holes Number	4
E	Fixing Holes Diam. mm	6.5
F	Fixing Holes Centreline Diam. mm	135

DIMENSIONS

A	Outside Diam. mm	174
B	Inside Diam. mm	38
C	Thickness mm	4
D	Fixing Holes Number	5
E	Fixing Holes Diam. mm	6.5
F	Fixing Holes Centreline Diam. mm	60

FMD0020R

Available

FRONT / REAR

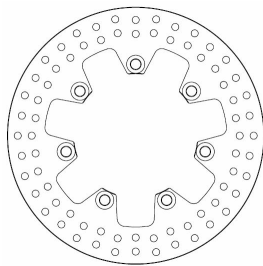
**FMD0022R**

Available

FRONT / REAR

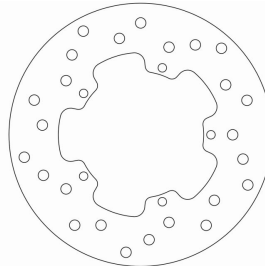
**FMD0023R**

Available

FRONT / REAR

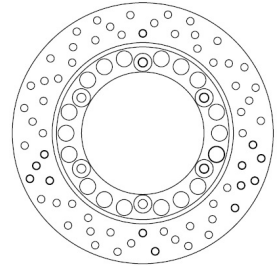
**DIMENSIONS**

A	Outside Diam. mm	270
B	Inside Diam. mm	130
C	Thickness mm	6
D	Fixing Holes Number	7
E	Fixing Holes Diam. mm	10.5
F	Fixing Holes Centreline Diam. mm	150

DIMENSIONS

A	Outside Diam. mm	200
B	Inside Diam. mm	96
C	Thickness mm	4
D	Fixing Holes Number	5
E	Fixing Holes Diam. mm	6.5
F	Fixing Holes Centreline Diam. mm	107

DIMENSIONS

A	Outside Diam. mm	245
B	Inside Diam. mm	115
C	Thickness mm	4
D	Fixing Holes Number	6
E	Fixing Holes Diam. mm	8.5
F	Fixing Holes Centreline Diam. mm	133

For A,B,C,D,E,F see first page of this section

12002**FERODO**

RACING

Updated on November 2020

FMD0025R

Available

FRONT / REAR

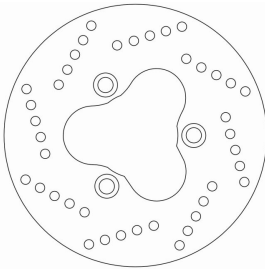
**FMD0026R**

Available

FRONT

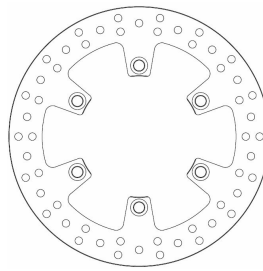
**FMD0027R**

Available

FRONT

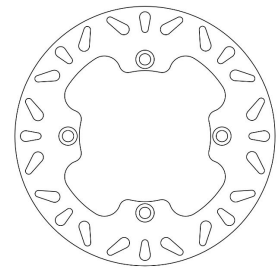
**DIMENSIONS**

A	Outside Diam. mm	180
B	Inside Diam. mm	58.0
C	Thickness mm	3.5
D	Fixing Holes Number	3
E	Fixing Holes Diam. mm	10.5
F	Fixing Holes Centreline Diam. mm	80

DIMENSIONS

A	Outside Diam. mm	260
B	Inside Diam. mm	121.2
C	Thickness mm	4
D	Fixing Holes Number	6
E	Fixing Holes Diam. mm	10.3
F	Fixing Holes Centreline Diam. mm	142

DIMENSIONS

A	Outside Diam. mm	242
B	Inside Diam. mm	121
C	Thickness mm	4
D	Fixing Holes Number	4
E	Fixing Holes Diam. mm	10.5
F	Fixing Holes Centreline Diam. mm	142

FMD0028RF

Available

FRONT

May 2018: R version OUT OF RANGE

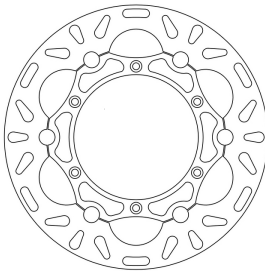
**FMD0028MXR**

Available

FRONT

May 2018: R version OUT OF RANGE

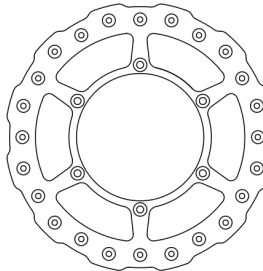
**FMD0029R**

Available

FRONT

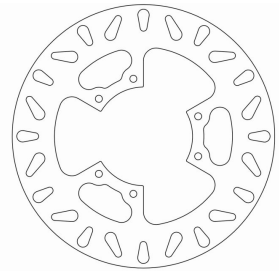
**DIMENSIONS**

A	Outside Diam. mm	250
B	Inside Diam. mm	118
C	Thickness mm	3
D	Fixing Holes Number	6
E	Fixing Holes Diam. mm	6.5
F	Fixing Holes Centreline Diam. mm	134

DIMENSIONS

A	Outside Diam. mm	250
B	Inside Diam. mm	118
C	Thickness mm	3
D	Fixing Holes Number	6
E	Fixing Holes Diam. mm	6.5
F	Fixing Holes Centreline Diam. mm	134

DIMENSIONS

A	Outside Diam. mm	230
B	Inside Diam. mm	85
C	Thickness mm	3
D	Fixing Holes Number	6
E	Fixing Holes Diam. mm	6.5
F	Fixing Holes Centreline Diam. mm	102

For A,B,C,D,E,F see first page of this section

FMD0030R

Available

FRONT

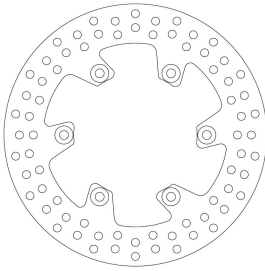
**DIMENSIONS**

A	Outside Diam. mm	245
B	Inside Diam. mm	115
C	Thickness mm	4
D	Fixing Holes Number	6
E	Fixing Holes Diam. mm	6.5
F	Fixing Holes Centreline Diam. mm	133

FMD0033R

Available

FRONT

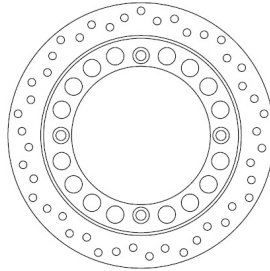
**DIMENSIONS**

A	Outside Diam. mm	276
B	Inside Diam. mm	144
C	Thickness mm	4
D	Fixing Holes Number	4
E	Fixing Holes Diam. mm	10.5
F	Fixing Holes Centreline Diam. mm	166

FMD0034R

Available

FRONT / REAR

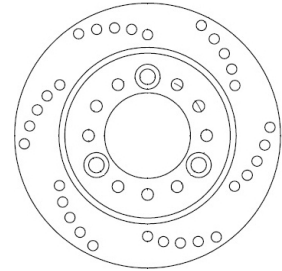
**DIMENSIONS**

A	Outside Diam. mm	180
B	Inside Diam. mm	58.2
C	Thickness mm	4
D	Fixing Holes Number	3
E	Fixing Holes Diam. mm	10.6
F	Fixing Holes Centreline Diam. mm	80

FMD0037R

Available

FRONT

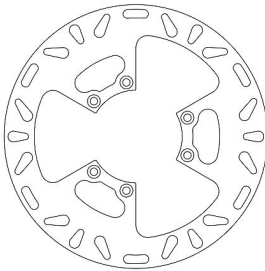
**DIMENSIONS**

A	Outside Diam. mm	245
B	Inside Diam. mm	86.1
C	Thickness mm	3
D	Fixing Holes Number	6
E	Fixing Holes Diam. mm	7
F	Fixing Holes Centreline Diam. mm	102

FMD0038RF

Available

FRONT

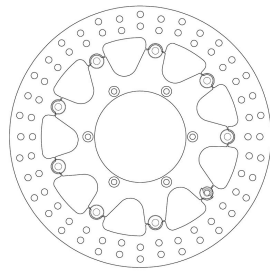
**DIMENSIONS**

A	Outside Diam. mm	298
B	Inside Diam. mm	105
C	Thickness mm	5
D	Fixing Holes Number	6
E	Fixing Holes Diam. mm	6.5
F	Fixing Holes Centreline Diam. mm	120

FMD0040R

Available

FRONT

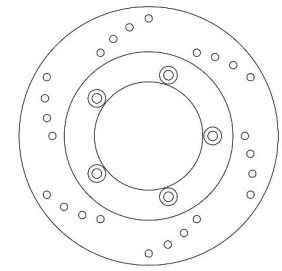
**DIMENSIONS**

A	Outside Diam. mm	175
B	Inside Diam. mm	73.3
C	Thickness mm	4
D	Fixing Holes Number	5
E	Fixing Holes Diam. mm	6.5
F	Fixing Holes Centreline Diam. mm	86.5

For A,B,C,D,E,F see first page of this section

12004**FERODO**

RACING

Updated on November 2020

FMD0042R

Available

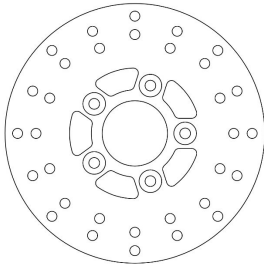
FRONT**FMD0043R**

Available

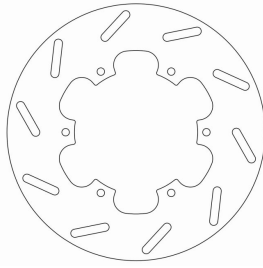
FRONT / REAR**FMD0045R**

Available

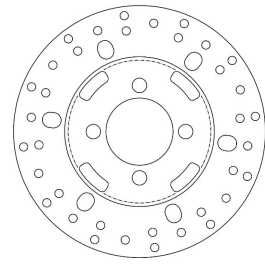
FRONT**DIMENSIONS**

A	Outside Diam. mm	155
B	Inside Diam. mm	30
C	Thickness mm	4
D	Fixing Holes Number	5
E	Fixing Holes Diam. mm	6.4
F	Fixing Holes Centreline Diam. mm	60

DIMENSIONS

A	Outside Diam. mm	220
B	Inside Diam. mm	105
C	Thickness mm	4
D	Fixing Holes Number	6
E	Fixing Holes Diam. mm	6.4
F	Fixing Holes Centreline Diam. mm	120

DIMENSIONS

A	Outside Diam. mm	180
B	Inside Diam. mm	48
C	Thickness mm	3.5
D	Fixing Holes Number	4
E	Fixing Holes Diam. mm	10.4
F	Fixing Holes Centreline Diam. mm	66

FMD0046R

Available

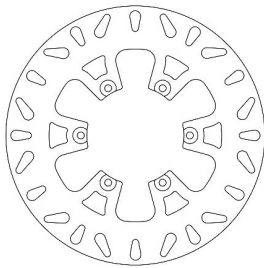
FRONT / REAR**FMD0047R**

Available

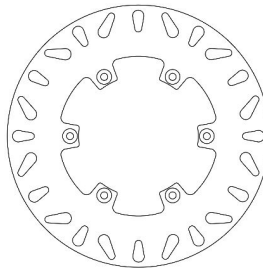
FRONT**FMD0048R**

Available

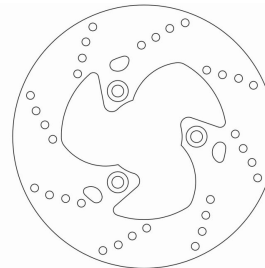
FRONT / REAR**DIMENSIONS**

A	Outside Diam. mm	240
B	Inside Diam. mm	90
C	Thickness mm	4
D	Fixing Holes Number	6
E	Fixing Holes Diam. mm	6.5
F	Fixing Holes Centreline Diam. mm	101

DIMENSIONS

A	Outside Diam. mm	230
B	Inside Diam. mm	105
C	Thickness mm	4
D	Fixing Holes Number	6
E	Fixing Holes Diam. mm	6.2
F	Fixing Holes Centreline Diam. mm	120

DIMENSIONS

A	Outside Diam. mm	200
B	Inside Diam. mm	58
C	Thickness mm	4
D	Fixing Holes Number	3
E	Fixing Holes Diam. mm	9
F	Fixing Holes Centreline Diam. mm	80

For A,B,C,D,E,F see first page of this section

FMD0050R

Available

FRONT

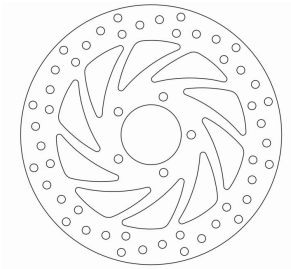
**FMD0051R**

Available

FRONT

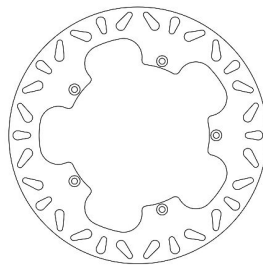
**FMD0053R**

Available

FRONT / REAR

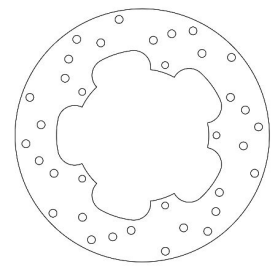
**DIMENSIONS**

A	Outside Diam. mm	260
B	Inside Diam. mm	60
C	Thickness mm	4
D	Fixing Holes Number	5
E	Fixing Holes Diam. mm	8.5
F	Fixing Holes Centreline Diam. mm	80

DIMENSIONS

A	Outside Diam. mm	280
B	Inside Diam. mm	155
C	Thickness mm	4
D	Fixing Holes Number	5
E	Fixing Holes Diam. mm	6.5
F	Fixing Holes Centreline Diam. mm	170

DIMENSIONS

A	Outside Diam. mm	240
B	Inside Diam. mm	125.5
C	Thickness mm	4
D	Fixing Holes Number	5
E	Fixing Holes Diam. mm	6.5
F	Fixing Holes Centreline Diam. mm	140

FMD0054R

Available

FRONT / REAR

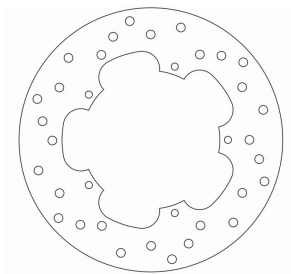
**FMD0055R**

Available

FRONT / REAR

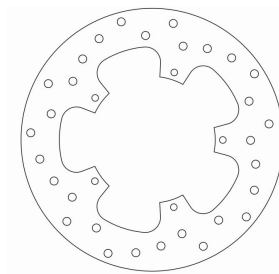
**FMD0057R**

Available

FRONT

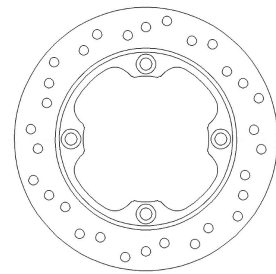
**DIMENSIONS**

A	Outside Diam. mm	240
B	Inside Diam. mm	125
C	Thickness mm	5
D	Fixing Holes Number	5
E	Fixing Holes Diam. mm	6.5
F	Fixing Holes Centreline Diam. mm	140

DIMENSIONS

A	Outside Diam. mm	260
B	Inside Diam. mm	125
C	Thickness mm	4
D	Fixing Holes Number	5
E	Fixing Holes Diam. mm	6.5
F	Fixing Holes Centreline Diam. mm	140

DIMENSIONS

A	Outside Diam. mm	220
B	Inside Diam. mm	105.3
C	Thickness mm	4
D	Fixing Holes Number	4
E	Fixing Holes Diam. mm	10.5
F	Fixing Holes Centreline Diam. mm	125

For A,B,C,D,E,F see first page of this section

12006**FERODO**

RACING

Updated on November 2020

FMD0059R

Available

REAR

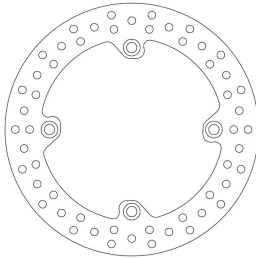
**FMD0064R**

Available

FRONT

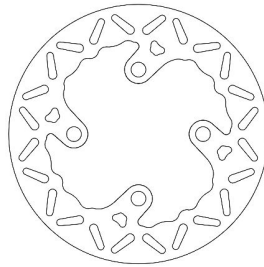
**FMD0073R**

Available

FRONT

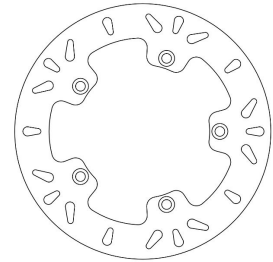
**DIMENSIONS**

A	Outside Diam. mm	256
B	Inside Diam. mm	144
C	Thickness mm	5
D	Fixing Holes Number	4
E	Fixing Holes Diam. mm	10.5
F	Fixing Holes Centreline Diam. mm	166

DIMENSIONS

A	Outside Diam. mm	185
B	Inside Diam. mm	72.2
C	Thickness mm	3
D	Fixing Holes Number	4
E	Fixing Holes Diam. mm	10.5
F	Fixing Holes Centreline Diam. mm	92

DIMENSIONS

A	Outside Diam. mm	276
B	Inside Diam. mm	144.1
C	Thickness mm	5
D	Fixing Holes Number	5
E	Fixing Holes Diam. mm	10.5
F	Fixing Holes Centreline Diam. mm	166

FMD0075R

Available

REAR

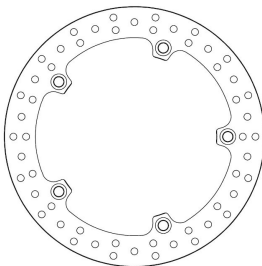
**FMD0076R**

Available

FRONT

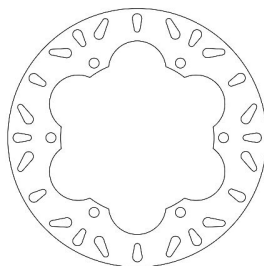
**FMD0077R**

Available

FRONT

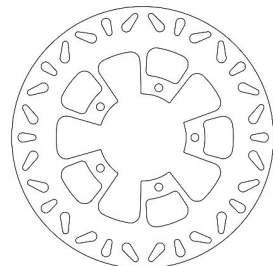
**DIMENSIONS**

A	Outside Diam. mm	276
B	Inside Diam. mm	174
C	Thickness mm	5
D	Fixing Holes Number	5
E	Fixing Holes Diam. mm	10.5
F	Fixing Holes Centreline Diam. mm	198

DIMENSIONS

A	Outside Diam. mm	270
B	Inside Diam. mm	160
C	Thickness mm	5
D	Fixing Holes Number	6
E	Fixing Holes Diam. mm	10.5
F	Fixing Holes Centreline Diam. mm	180

DIMENSIONS

A	Outside Diam. mm	280
B	Inside Diam. mm	93
C	Thickness mm	5
D	Fixing Holes Number	5
E	Fixing Holes Diam. mm	8.5
F	Fixing Holes Centreline Diam. mm	111.7

For A,B,C,D,E,F see first page of this section

FMD0078R

Available

FRONT

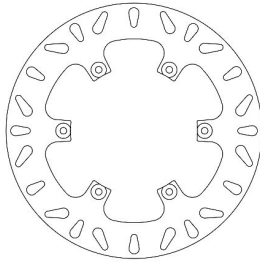

DIMENSIONS		
A	Outside Diam. mm	250
B	Inside Diam. mm	124.1
C	Thickness mm	4
D	Fixing Holes Number	6
E	Fixing Holes Diam. mm	6.5
F	Fixing Holes Centreline Diam. mm	138

FMD0080R

Available

FRONT / REAR

Includes mounting bolt kit

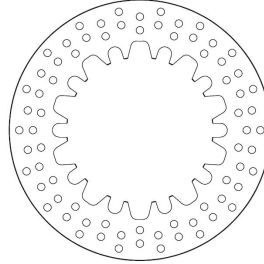

DIMENSIONS		
A	Outside Diam. mm	260
B	Inside Diam. mm	145
C	Thickness mm	5
D	Fixing Holes Number	10
E	Fixing Holes Diam. mm	13.8
F	Fixing Holes Centreline Diam. mm	158

FMD0081R

Available

FRONT / REAR

Includes mounting bolt kit

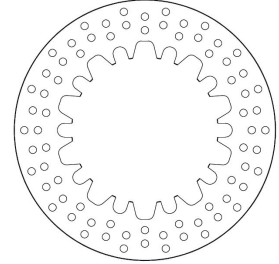

DIMENSIONS		
A	Outside Diam. mm	285
B	Inside Diam. mm	165
C	Thickness mm	5
D	Fixing Holes Number	10
E	Fixing Holes Diam. mm	13.8
F	Fixing Holes Centreline Diam. mm	178

FMD0083R

Available

FRONT

From Nov. 2013 includes kit for new BMW (model 2007 onwards)

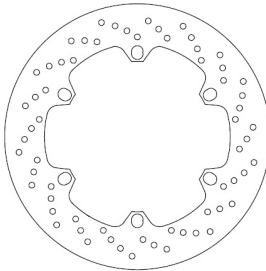

DIMENSIONS		
A	Outside Diam. mm	320
B	Inside Diam. mm	181
C	Thickness mm	4.6
D	Fixing Holes Number	5
E	Fixing Holes Diam. mm	13.8x16.8
F	Fixing Holes Centreline Diam. mm	203.4

FMD0085R

Available

FRONT / REAR

May 2016: RP out of range

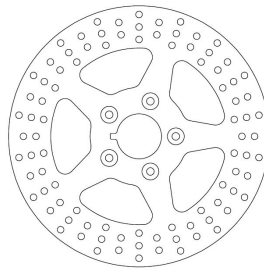

DIMENSIONS		
A	Outside Diam. mm	292
B	Inside Diam. mm	50.5
C	Thickness mm	5
D	Fixing Holes Number	5
E	Fixing Holes Diam. mm	8.5
F	Fixing Holes Centreline Diam. mm	82.5

FMD0085RF

Available

FRONT / REAR

May 2016: RP out of range

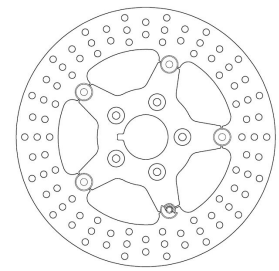

DIMENSIONS		
A	Outside Diam. mm	292
B	Inside Diam. mm	50.5
C	Thickness mm	5
D	Fixing Holes Number	5
E	Fixing Holes Diam. mm	8.5
F	Fixing Holes Centreline Diam. mm	82.5

For A,B,C,D,E,F see first page of this section

12008**FERODO**

RACING

Updated on November 2020

FMD0085RPF

Available

FRONT / REAR

May 2016: RP out of range

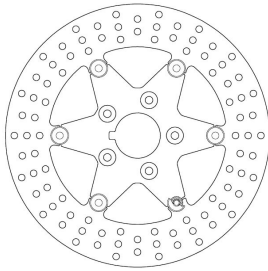
**DIMENSIONS**

A	Outside Diam. mm	292
B	Inside Diam. mm	50.5
C	Thickness mm	5
D	Fixing Holes Number	5
E	Fixing Holes Diam. mm	8.5
F	Fixing Holes Centreline Diam. mm	82.5

FMD0087R

Available

FRONT

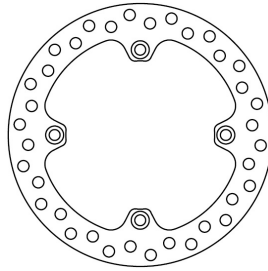
**DIMENSIONS**

A	Outside Diam. mm	256
B	Inside Diam. mm	144
C	Thickness mm	4
D	Fixing Holes Number	4
E	Fixing Holes Diam. mm	10.5
F	Fixing Holes Centreline Diam. mm	166

FMD0088R

Available

FRONT

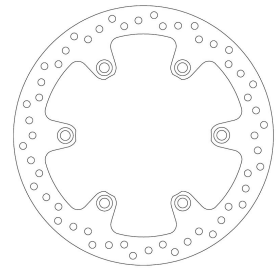
**DIMENSIONS**

A	Outside Diam. mm	276
B	Inside Diam. mm	144
C	Thickness mm	4
D	Fixing Holes Number	6
E	Fixing Holes Diam. mm	10.5
F	Fixing Holes Centreline Diam. mm	166

FMD0089R

Available

FRONT

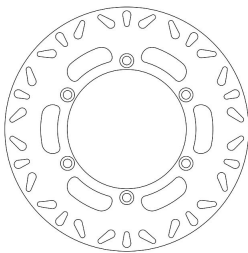
**DIMENSIONS**

A	Outside Diam. mm	296
B	Inside Diam. mm	144
C	Thickness mm	4
D	Fixing Holes Number	6
E	Fixing Holes Diam. mm	10.5
F	Fixing Holes Centreline Diam. mm	166

FMD0090R

Available

FRONT / REAR

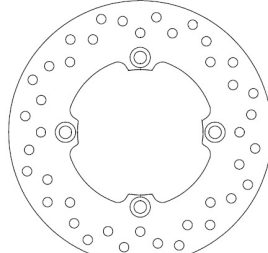
**DIMENSIONS**

A	Outside Diam. mm	220
B	Inside Diam. mm	105
C	Thickness mm	4
D	Fixing Holes Number	4
E	Fixing Holes Diam. mm	10.5
F	Fixing Holes Centreline Diam. mm	125

FMD0091R

Available

FRONT

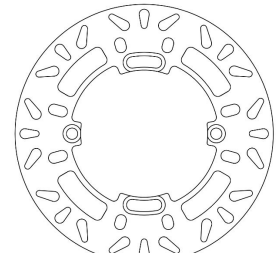
**DIMENSIONS**

A	Outside Diam. mm	240
B	Inside Diam. mm	118
C	Thickness mm	3
D	Fixing Holes Number	4
E	Fixing Holes Diam. mm	6.5
F	Fixing Holes Centreline Diam. mm	134

For A,B,C,D,E,F see first page of this section

FMD0092R

Available

FRONT

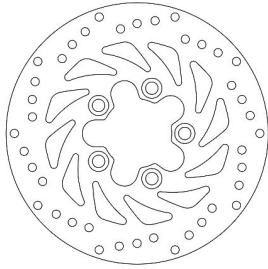
**FMD0093R**

Available

FRONT / REAR

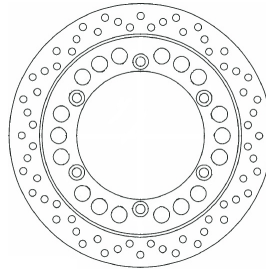
**FMD0094R**

Available

FRONT

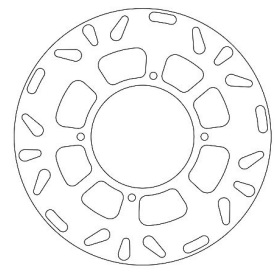
**DIMENSIONS**

A	Outside Diam. mm	220
B	Inside Diam. mm	58
C	Thickness mm	4
D	Fixing Holes Number	5
E	Fixing Holes Diam. mm	10.5
F	Fixing Holes Centreline Diam. mm	80

DIMENSIONS

A	Outside Diam. mm	296
B	Inside Diam. mm	144.5
C	Thickness mm	5
D	Fixing Holes Number	6
E	Fixing Holes Diam. mm	10.5
F	Fixing Holes Centreline Diam. mm	166

DIMENSIONS

A	Outside Diam. mm	220
B	Inside Diam. mm	88.2
C	Thickness mm	3
D	Fixing Holes Number	4
E	Fixing Holes Diam. mm	6.3
F	Fixing Holes Centreline Diam. mm	106

FMD0095MXR

Available

FRONT

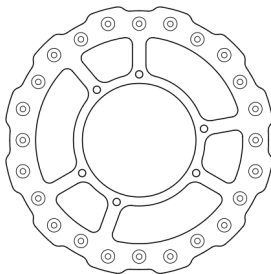
**FMD0096R**

Available

FRONT / REAR

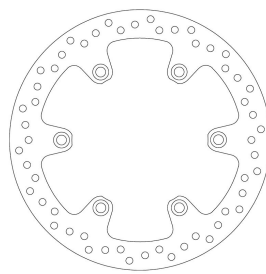
**FMD0097R**

Available

FRONT / REAR

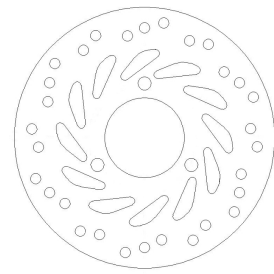
**DIMENSIONS**

A	Outside Diam. mm	240
B	Inside Diam. mm	101.3
C	Thickness mm	3
D	Fixing Holes Number	6
E	Fixing Holes Diam. mm	6.5
F	Fixing Holes Centreline Diam. mm	117

DIMENSIONS

A	Outside Diam. mm	276
B	Inside Diam. mm	144
C	Thickness mm	5
D	Fixing Holes Number	6
E	Fixing Holes Diam. mm	10.5
F	Fixing Holes Centreline Diam. mm	166

DIMENSIONS

A	Outside Diam. mm	190
B	Inside Diam. mm	58.2
C	Thickness mm	4
D	Fixing Holes Number	3
E	Fixing Holes Diam. mm	10
F	Fixing Holes Centreline Diam. mm	79.5

For A,B,C,D,E,F see first page of this section

12010**FERODO**

RACING

Updated on November 2020

FMD0098R

Available

FRONT / REAR

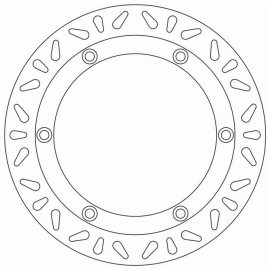
**FMD0100R**

Available

FRONT

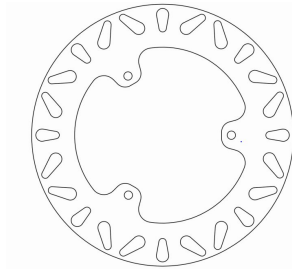
**FMD0101R**

Available

FRONT / REAR

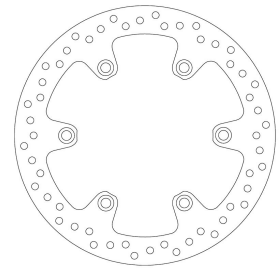
**DIMENSIONS**

A	Outside Diam. mm	296
B	Inside Diam. mm	184.5
C	Thickness mm	6
D	Fixing Holes Number	6
E	Fixing Holes Diam. mm	10.5
F	Fixing Holes Centreline Diam. mm	206

DIMENSIONS

A	Outside Diam. mm	200
B	Inside Diam. mm	88
C	Thickness mm	3
D	Fixing Holes Number	3
E	Fixing Holes Diam. mm	6.5
F	Fixing Holes Centreline Diam. mm	105

DIMENSIONS

A	Outside Diam. mm	270
B	Inside Diam. mm	130
C	Thickness mm	5
D	Fixing Holes Number	6
E	Fixing Holes Diam. mm	10.5
F	Fixing Holes Centreline Diam. mm	150

FMD0103R

Available

FRONT

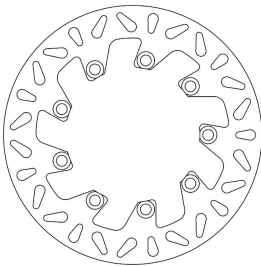
**FMD0104R**

Available

FRONT / REAR

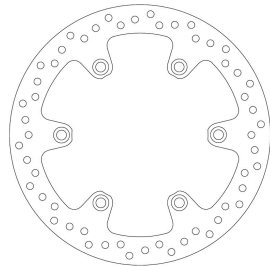
**FMD0105R**

Available

FRONT

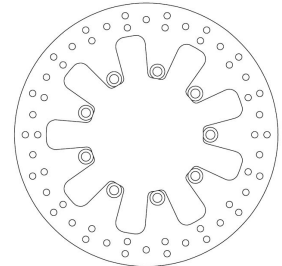
**DIMENSIONS**

A	Outside Diam. mm	250
B	Inside Diam. mm	130
C	Thickness mm	4
D	Fixing Holes Number	9
E	Fixing Holes Diam. mm	10.5
F	Fixing Holes Centreline Diam. mm	146

DIMENSIONS

A	Outside Diam. mm	260
B	Inside Diam. mm	130
C	Thickness mm	5
D	Fixing Holes Number	6
E	Fixing Holes Diam. mm	10.5
F	Fixing Holes Centreline Diam. mm	150

DIMENSIONS

A	Outside Diam. mm	300
B	Inside Diam. mm	130
C	Thickness mm	5
D	Fixing Holes Number	9
E	Fixing Holes Diam. mm	10.5
F	Fixing Holes Centreline Diam. mm	146

For A,B,C,D,E,F see first page of this section

FMD0106R

Available

FRONT

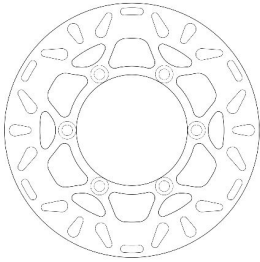
**FMD0110R**

Available

FRONT

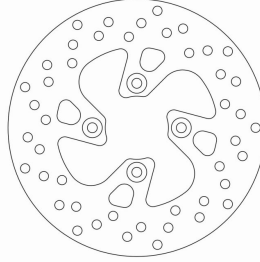
**FMD0111RX**

Available

FRONT

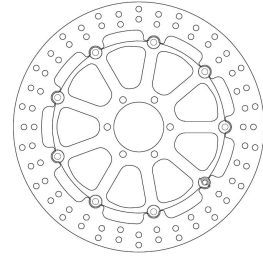
**DIMENSIONS**

A	Outside Diam. mm	220.6
B	Inside Diam. mm	96.2
C	Thickness mm	3
D	Fixing Holes Number	6
E	Fixing Holes Diam. mm	9.3
F	Fixing Holes Centreline Diam. mm	112

DIMENSIONS

A	Outside Diam. mm	220
B	Inside Diam. mm	54
C	Thickness mm	4
D	Fixing Holes Number	4
E	Fixing Holes Diam. mm	8.5
F	Fixing Holes Centreline Diam. mm	76

DIMENSIONS

A	Outside Diam. mm	320
B	Inside Diam. mm	64
C	Thickness mm	5
D	Fixing Holes Number	6
E	Fixing Holes Diam. mm	8.5
F	Fixing Holes Centreline Diam. mm	80

FMD0112RX

Available

FRONT

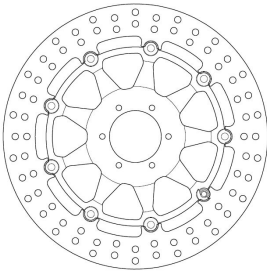
**FMD0113RX**

Available

FRONT

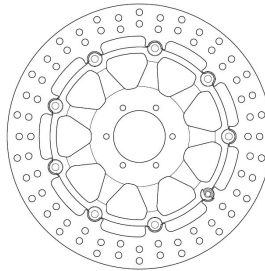
**FMD0114RX**

Available

FRONT

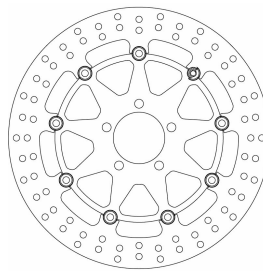
**DIMENSIONS**

A	Outside Diam. mm	296
B	Inside Diam. mm	58
C	Thickness mm	5
D	Fixing Holes Number	6
E	Fixing Holes Diam. mm	6.5
F	Fixing Holes Centreline Diam. mm	74

DIMENSIONS

A	Outside Diam. mm	296
B	Inside Diam. mm	62
C	Thickness mm	5
D	Fixing Holes Number	6
E	Fixing Holes Diam. mm	6.5
F	Fixing Holes Centreline Diam. mm	78

DIMENSIONS

A	Outside Diam. mm	310
B	Inside Diam. mm	61
C	Thickness mm	5
D	Fixing Holes Number	5
E	Fixing Holes Diam. mm	10.5
F	Fixing Holes Centreline Diam. mm	81

For A,B,C,D,E,F see first page of this section

FMD0115RX

Available

FRONT

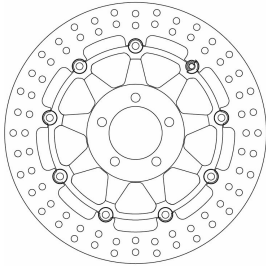
**FMD0116RX**

Available

FRONT

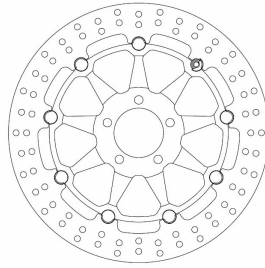
**FMD0117RX**

Available

FRONT

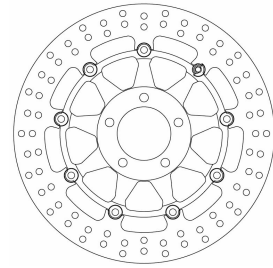
**DIMENSIONS**

A	Outside Diam. mm	300
B	Inside Diam. mm	61
C	Thickness mm	5
D	Fixing Holes Number	5
E	Fixing Holes Diam. mm	10.5
F	Fixing Holes Centreline Diam. mm	81

DIMENSIONS

A	Outside Diam. mm	320
B	Inside Diam. mm	61
C	Thickness mm	5
D	Fixing Holes Number	5
E	Fixing Holes Diam. mm	10.5
F	Fixing Holes Centreline Diam. mm	81

DIMENSIONS

A	Outside Diam. mm	310
B	Inside Diam. mm	64
C	Thickness mm	5
D	Fixing Holes Number	5
E	Fixing Holes Diam. mm	10.5
F	Fixing Holes Centreline Diam. mm	86

FMD0118RX

Available

FRONT

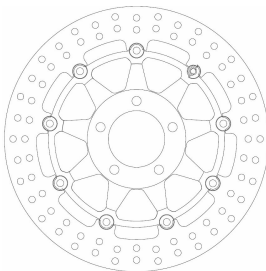
**FMD0119RX**

Available

FRONT

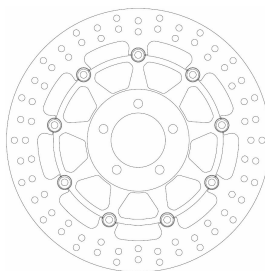
**FMD0120RX**

Available

FRONT

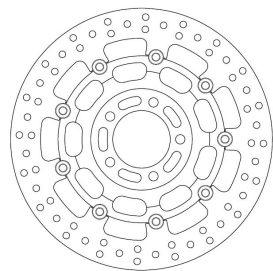
**DIMENSIONS**

A	Outside Diam. mm	300
B	Inside Diam. mm	64
C	Thickness mm	5
D	Fixing Holes Number	5
E	Fixing Holes Diam. mm	10.5
F	Fixing Holes Centreline Diam. mm	86

DIMENSIONS

A	Outside Diam. mm	310
B	Inside Diam. mm	64
C	Thickness mm	5
D	Fixing Holes Number	5
E	Fixing Holes Diam. mm	10.5
F	Fixing Holes Centreline Diam. mm	86

DIMENSIONS

A	Outside Diam. mm	290
B	Inside Diam. mm	64
C	Thickness mm	5
D	Fixing Holes Number	5
E	Fixing Holes Diam. mm	10.5
F	Fixing Holes Centreline Diam. mm	86

For A,B,C,D,E,F see first page of this section

FMD0121RX

Available

FRONT

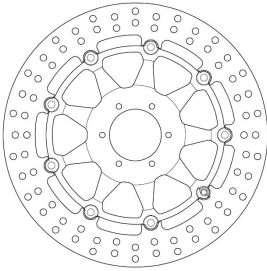
**FMD0123RX**

Available

FRONT

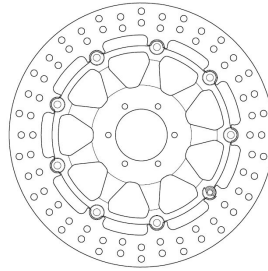
**FMD0125RX**

Available

FRONT

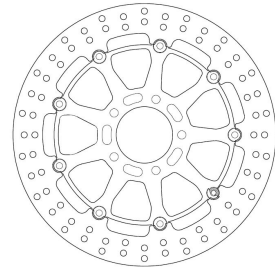
**DIMENSIONS**

A	Outside Diam. mm	300
B	Inside Diam. mm	64
C	Thickness mm	5
D	Fixing Holes Number	6
E	Fixing Holes Diam. mm	8.5
F	Fixing Holes Centreline Diam. mm	80

DIMENSIONS

A	Outside Diam. mm	310
B	Inside Diam. mm	58
C	Thickness mm	5
D	Fixing Holes Number	6
E	Fixing Holes Diam. mm	6.5
F	Fixing Holes Centreline Diam. mm	74

DIMENSIONS

A	Outside Diam. mm	320
B	Inside Diam. mm	69
C	Thickness mm	5
D	Fixing Holes Number	5
E	Fixing Holes Diam. mm	10.5
F	Fixing Holes Centreline Diam. mm	91

FMD0126RX

Available

FRONT / REAR

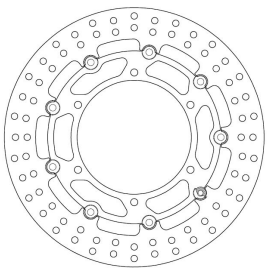
**FMD0128RX**

Available

FRONT

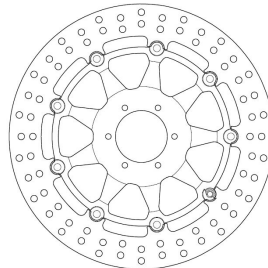
**FMD0129RX**

Available

FRONT

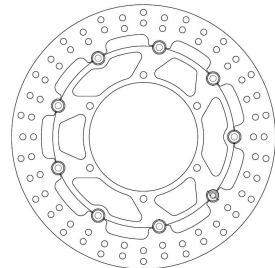
**DIMENSIONS**

A	Outside Diam. mm	300
B	Inside Diam. mm	132
C	Thickness mm	5
D	Fixing Holes Number	6
E	Fixing Holes Diam. mm	8.5
F	Fixing Holes Centreline Diam. mm	150

DIMENSIONS

A	Outside Diam. mm	310
B	Inside Diam. mm	62
C	Thickness mm	5
D	Fixing Holes Number	6
E	Fixing Holes Diam. mm	6.5
F	Fixing Holes Centreline Diam. mm	78

DIMENSIONS

A	Outside Diam. mm	320
B	Inside Diam. mm	132
C	Thickness mm	5
D	Fixing Holes Number	6
E	Fixing Holes Diam. mm	8.5
F	Fixing Holes Centreline Diam. mm	150

For A,B,C,D,E,F see first page of this section

FMD0130RX

Available

FRONT

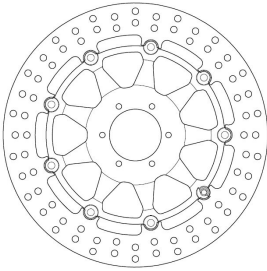
**FMD0132RX**

Available

FRONT

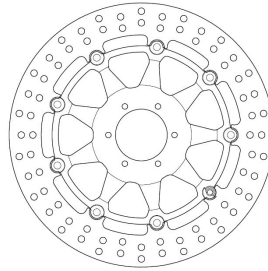
**FMD0133R**

Available

REAR

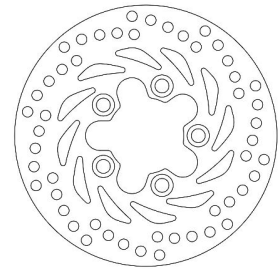
**DIMENSIONS**

A	Outside Diam. mm	330
B	Inside Diam. mm	94
C	Thickness mm	5
D	Fixing Holes Number	6
E	Fixing Holes Diam. mm	6.5
F	Fixing Holes Centreline Diam. mm	110

DIMENSIONS

A	Outside Diam. mm	300
B	Inside Diam. mm	61
C	Thickness mm	5
D	Fixing Holes Number	6
E	Fixing Holes Diam. mm	8.5
F	Fixing Holes Centreline Diam. mm	80

DIMENSIONS

A	Outside Diam. mm	200
B	Inside Diam. mm	58
C	Thickness mm	4
D	Fixing Holes Number	5
E	Fixing Holes Diam. mm	10.5
F	Fixing Holes Centreline Diam. mm	80

FMD0134RX

Available

FRONT

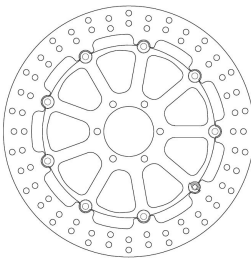
**FMD0135RX**

Available

FRONT

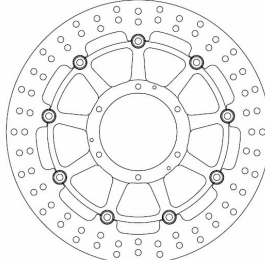
**FMD0137RX**

Available

FRONT

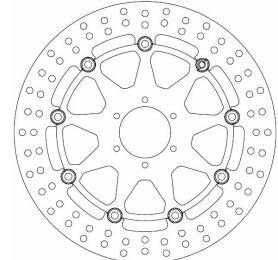
**DIMENSIONS**

A	Outside Diam. mm	296
B	Inside Diam. mm	94
C	Thickness mm	5
D	Fixing Holes Number	6
E	Fixing Holes Diam. mm	6.5
F	Fixing Holes Centreline Diam. mm	110

DIMENSIONS

A	Outside Diam. mm	320
B	Inside Diam. mm	94
C	Thickness mm	5
D	Fixing Holes Number	6
E	Fixing Holes Diam. mm	6.5
F	Fixing Holes Centreline Diam. mm	110

DIMENSIONS

A	Outside Diam. mm	296
B	Inside Diam. mm	58
C	Thickness mm	5
D	Fixing Holes Number	6
E	Fixing Holes Diam. mm	6.5
F	Fixing Holes Centreline Diam. mm	74

For A,B,C,D,E,F see first page of this section

FMD0139RX

Available

FRONT

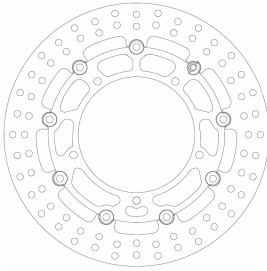
**FMD0140RX**

Available

FRONT

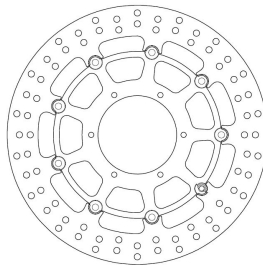
**FMD0146RX**

Available

FRONT

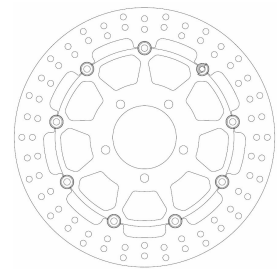
**DIMENSIONS**

A	Outside Diam. mm	300
B	Inside Diam. mm	132
C	Thickness mm	5
D	Fixing Holes Number	5
E	Fixing Holes Diam. mm	8.5
F	Fixing Holes Centreline Diam. mm	150

DIMENSIONS

A	Outside Diam. mm	310
B	Inside Diam. mm	94
C	Thickness mm	5
D	Fixing Holes Number	6
E	Fixing Holes Diam. mm	6.5
F	Fixing Holes Centreline Diam. mm	110

DIMENSIONS

A	Outside Diam. mm	320
B	Inside Diam. mm	78
C	Thickness mm	5
D	Fixing Holes Number	5
E	Fixing Holes Diam. mm	10.5
F	Fixing Holes Centreline Diam. mm	100.5

FMD0147RX

Available

FRONT

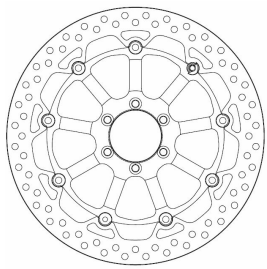
**FMD0148R**

Available

FRONT

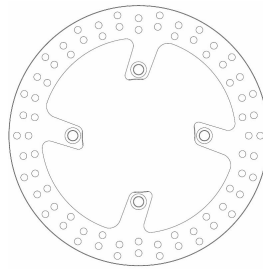
**FMD0151R**

Available

FRONT

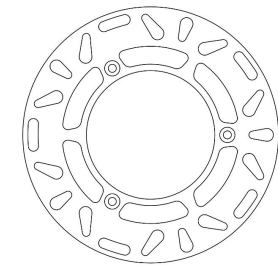
**DIMENSIONS**

A	Outside Diam. mm	320
B	Inside Diam. mm	64
C	Thickness mm	5
D	Fixing Holes Number	6
E	Fixing Holes Diam. mm	8.5
F	Fixing Holes Centreline Diam. mm	80

DIMENSIONS

A	Outside Diam. mm	280
B	Inside Diam. mm	121
C	Thickness mm	4
D	Fixing Holes Number	4
E	Fixing Holes Diam. mm	10.5
F	Fixing Holes Centreline Diam. mm	142

DIMENSIONS

A	Outside Diam. mm	200
B	Inside Diam. mm	100
C	Thickness mm	3.2
D	Fixing Holes Number	3
E	Fixing Holes Diam. mm	6
F	Fixing Holes Centreline Diam. mm	120

For A,B,C,D,E,F see first page of this section

FMD0155R

Available

FRONT / REAR

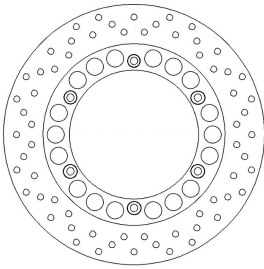
**FMD0156R**

Available

REAR

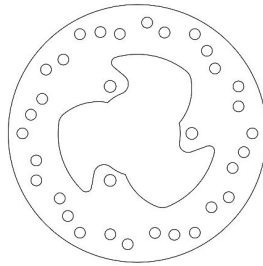
**FMD0157R**

Available

FRONT

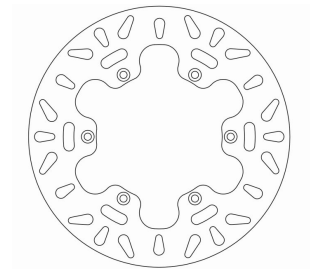
**DIMENSIONS**

A	Outside Diam. mm	267
B	Inside Diam. mm	132
C	Thickness mm	5
D	Fixing Holes Number	6
E	Fixing Holes Diam. mm	8.5
F	Fixing Holes Centreline Diam. mm	150

DIMENSIONS

A	Outside Diam. mm	190
B	Inside Diam. mm	62
C	Thickness mm	5
D	Fixing Holes Number	3
E	Fixing Holes Diam. mm	8.7
F	Fixing Holes Centreline Diam. mm	80

DIMENSIONS

A	Outside Diam. mm	245
B	Inside Diam. mm	118
C	Thickness mm	3
D	Fixing Holes Number	6
E	Fixing Holes Diam. mm	6.5
F	Fixing Holes Centreline Diam. mm	134

FMD0159R

Available

FRONT

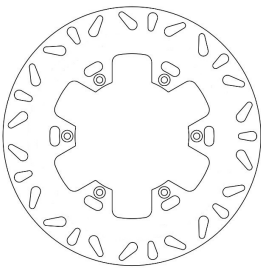
**FMD0160R**

Available

FRONT / REAR

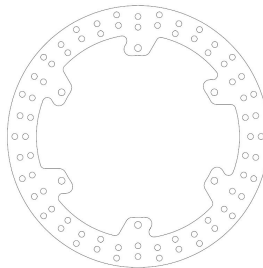
**FMD0163R**

Available

FRONT / REAR

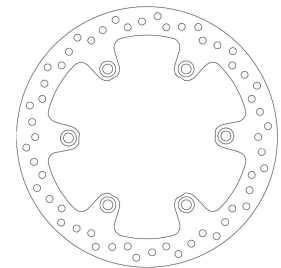
**DIMENSIONS**

A	Outside Diam. mm	267
B	Inside Diam. mm	118
C	Thickness mm	4
D	Fixing Holes Number	6
E	Fixing Holes Diam. mm	6.5
F	Fixing Holes Centreline Diam. mm	134

DIMENSIONS

A	Outside Diam. mm	320
B	Inside Diam. mm	198
C	Thickness mm	5
D	Fixing Holes Number	6
E	Fixing Holes Diam. mm	8.5
F	Fixing Holes Centreline Diam. mm	216

DIMENSIONS

A	Outside Diam. mm	282
B	Inside Diam. mm	132.1
C	Thickness mm	5
D	Fixing Holes Number	6
E	Fixing Holes Diam. mm	8.6
F	Fixing Holes Centreline Diam. mm	150

For A,B,C,D,E,F see first page of this section

FMD0163RF

Available

FRONT / REAR

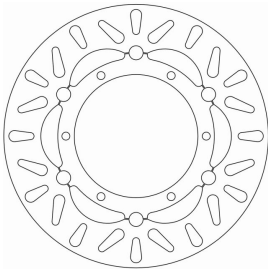
**FMD0164R**

Available

REAR

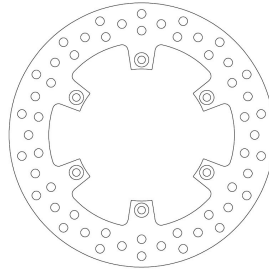
**FMD0165R**

Available

FRONT

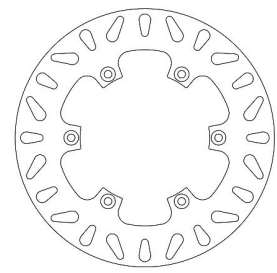
**DIMENSIONS**

A	Outside Diam. mm	282
B	Inside Diam. mm	132.1
C	Thickness mm	5
D	Fixing Holes Number	6
E	Fixing Holes Diam. mm	8.6
F	Fixing Holes Centreline Diam. mm	150

DIMENSIONS

A	Outside Diam. mm	220
B	Inside Diam. mm	110
C	Thickness mm	4
D	Fixing Holes Number	6
E	Fixing Holes Diam. mm	6.5
F	Fixing Holes Centreline Diam. mm	124

DIMENSIONS

A	Outside Diam. mm	220
B	Inside Diam. mm	110
C	Thickness mm	4
D	Fixing Holes Number	6
E	Fixing Holes Diam. mm	6.5
F	Fixing Holes Centreline Diam. mm	125

FMD0166R

Available

REAR

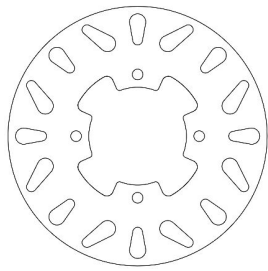
**FMD0167R**

Available

REAR

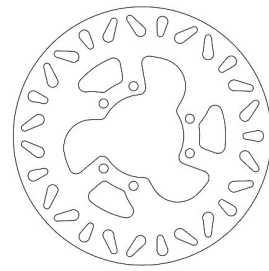
**FMD0168R**

Available

FRONT

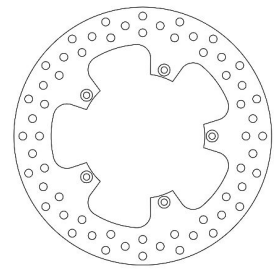
**DIMENSIONS**

A	Outside Diam. mm	160
B	Inside Diam. mm	60.2
C	Thickness mm	4
D	Fixing Holes Number	4
E	Fixing Holes Diam. mm	6.5
F	Fixing Holes Centreline Diam. mm	76

DIMENSIONS

A	Outside Diam. mm	184
B	Inside Diam. mm	59
C	Thickness mm	4
D	Fixing Holes Number	6
E	Fixing Holes Diam. mm	6.5
F	Fixing Holes Centreline Diam. mm	72

DIMENSIONS

A	Outside Diam. mm	260
B	Inside Diam. mm	125
C	Thickness mm	5
D	Fixing Holes Number	5
E	Fixing Holes Diam. mm	6.5
F	Fixing Holes Centreline Diam. mm	140

For A,B,C,D,E,F see first page of this section

FMD0170R

Available

FRONT / REAR

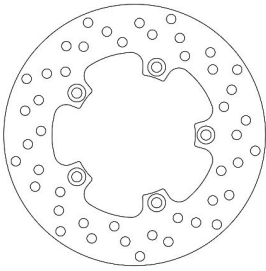
**FMD0171R**

In Introduction

REAR

Stock available : Q3 2019

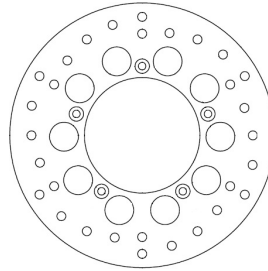
**FMD0172R**

Available

REAR

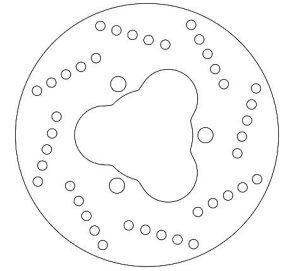
**DIMENSIONS**

A	Outside Diam. mm	220
B	Inside Diam. mm	102
C	Thickness mm	4
D	Fixing Holes Number	5
E	Fixing Holes Diam. mm	8.5
F	Fixing Holes Centreline Diam. mm	120

DIMENSIONS

A	Outside Diam. mm	220
B	Inside Diam. mm	96
C	Thickness mm	4
D	Fixing Holes Number	5
E	Fixing Holes Diam. mm	6.5
F	Fixing Holes Centreline Diam. mm	115

DIMENSIONS

A	Outside Diam. mm	180
B	Inside Diam. mm	62.5
C	Thickness mm	3.5
D	Fixing Holes Number	3
E	Fixing Holes Diam. mm	10.5
F	Fixing Holes Centreline Diam. mm	80

FMD0173R

Available

REAR

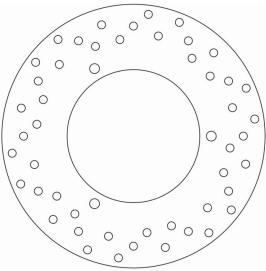
**FMD0175R**

Available

FRONT

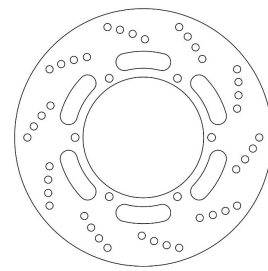
**FMD0176R**

Available

REAR

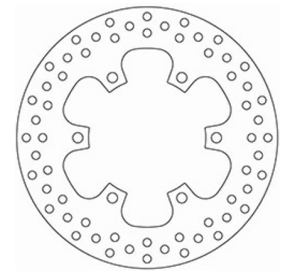
**DIMENSIONS**

A	Outside Diam. mm	230
B	Inside Diam. mm	116
C	Thickness mm	5
D	Fixing Holes Number	3
E	Fixing Holes Diam. mm	8.5
F	Fixing Holes Centreline Diam. mm	136

DIMENSIONS

A	Outside Diam. mm	282
B	Inside Diam. mm	132.2
C	Thickness mm	4
D	Fixing Holes Number	6
E	Fixing Holes Diam. mm	8.6
F	Fixing Holes Centreline Diam. mm	149.5

DIMENSIONS

A	Outside Diam. mm	256
B	Inside Diam. mm	115.1
C	Thickness mm	5.5
D	Fixing Holes Number	6
E	Fixing Holes Diam. mm	10
F	Fixing Holes Centreline Diam. mm	136

For A,B,C,D,E,F see first page of this section

FMD0179R

Available

REAR

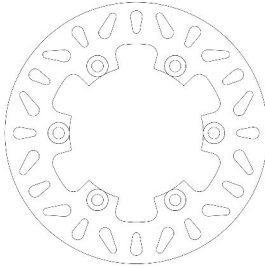
**FMD0180R**

Available

REAR

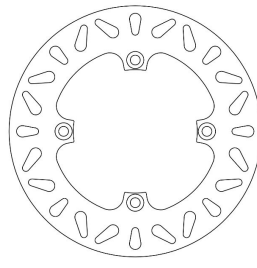
**FMD0182R**

Available

FRONT / REAR

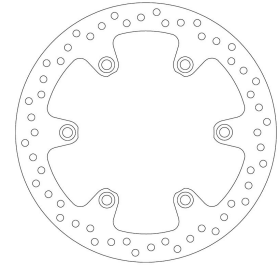
**DIMENSIONS**

A	Outside Diam. mm	220
B	Inside Diam. mm	112.1
C	Thickness mm	5
D	Fixing Holes Number	6
E	Fixing Holes Diam. mm	9.7
F	Fixing Holes Centreline Diam. mm	130

DIMENSIONS

A	Outside Diam. mm	218.5
B	Inside Diam. mm	108.5
C	Thickness mm	5
D	Fixing Holes Number	4
E	Fixing Holes Diam. mm	8.5
F	Fixing Holes Centreline Diam. mm	125

DIMENSIONS

A	Outside Diam. mm	220
B	Inside Diam. mm	115
C	Thickness mm	4
D	Fixing Holes Number	6
E	Fixing Holes Diam. mm	6.5
F	Fixing Holes Centreline Diam. mm	133

FMD0184MXR

Available

REAR

MXR version TH = 4.5mm

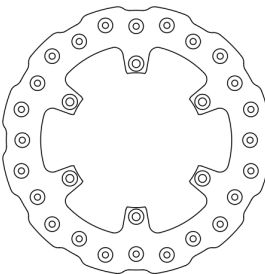
**FMD0185R**

Available

REAR

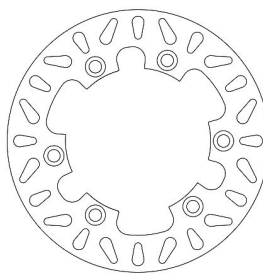
**FMD0186MXR**

Available

REAR

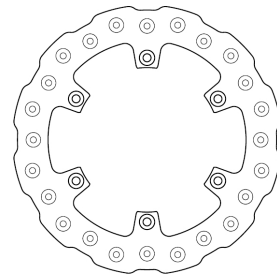
**DIMENSIONS**

A	Outside Diam. mm	220
B	Inside Diam. mm	110
C	Thickness mm	4.5
D	Fixing Holes Number	6
E	Fixing Holes Diam. mm	6.5
F	Fixing Holes Centreline Diam. mm	125

DIMENSIONS

A	Outside Diam. mm	220
B	Inside Diam. mm	122
C	Thickness mm	5
D	Fixing Holes Number	6
E	Fixing Holes Diam. mm	10.5
F	Fixing Holes Centreline Diam. mm	143.5

DIMENSIONS

A	Outside Diam. mm	220
B	Inside Diam. mm	117.9
C	Thickness mm	4
D	Fixing Holes Number	6
E	Fixing Holes Diam. mm	6.5
F	Fixing Holes Centreline Diam. mm	133.8

For A,B,C,D,E,F see first page of this section

12020**FERODO**

RACING

Updated on November 2020

FMD0187R

Available

REAR

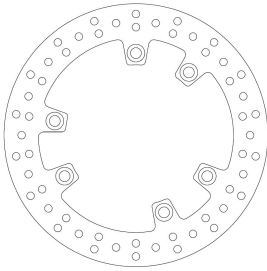
**FMD0190R**

Available

REAR

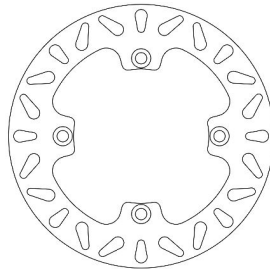
**FMD0197MXR**

Available

REAR

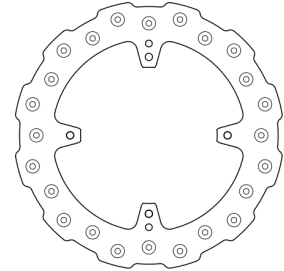
**DIMENSIONS**

A	Outside Diam. mm	250
B	Inside Diam. mm	134
C	Thickness mm	5
D	Fixing Holes Number	6
E	Fixing Holes Diam. mm	10.5
F	Fixing Holes Centreline Diam. mm	156

DIMENSIONS

A	Outside Diam. mm	220
B	Inside Diam. mm	112.2
C	Thickness mm	4
D	Fixing Holes Number	4
E	Fixing Holes Diam. mm	9.5
F	Fixing Holes Centreline Diam. mm	130

DIMENSIONS

A	Outside Diam. mm	240
B	Inside Diam. mm	121.5
C	Thickness mm	3.5
D	Fixing Holes Number	4
E	Fixing Holes Diam. mm	6.5
F	Fixing Holes Centreline Diam. mm	140

FMD0199R

Available

REAR

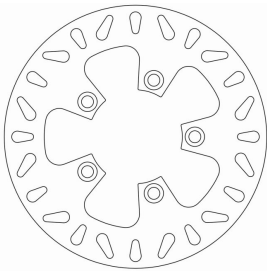
**FMD0203R**

Available

REAR

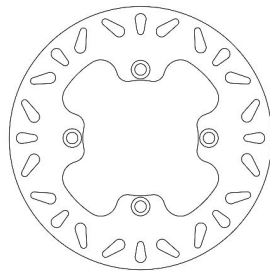
**FMD0206RF**

Available

FRONT

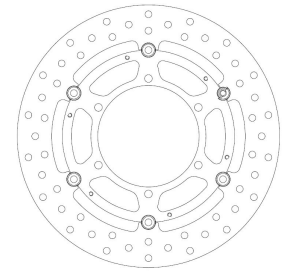
**DIMENSIONS**

A	Outside Diam. mm	230
B	Inside Diam. mm	82
C	Thickness mm	4
D	Fixing Holes Number	5
E	Fixing Holes Diam. mm	10.5
F	Fixing Holes Centreline Diam. mm	104

DIMENSIONS

A	Outside Diam. mm	240
B	Inside Diam. mm	105.4
C	Thickness mm	6
D	Fixing Holes Number	4
E	Fixing Holes Diam. mm	10.5
F	Fixing Holes Centreline Diam. mm	125

DIMENSIONS

A	Outside Diam. mm	305
B	Inside Diam. mm	118
C	Thickness mm	5
D	Fixing Holes Number	6
E	Fixing Holes Diam. mm	9
F	Fixing Holes Centreline Diam. mm	134

For A,B,C,D,E,F see first page of this section

FMD0207R

Available

REAR

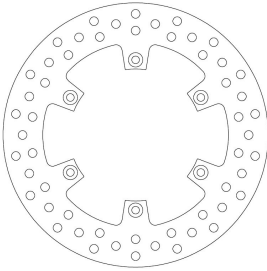
**FMD0210R**

Available

FRONT / REAR

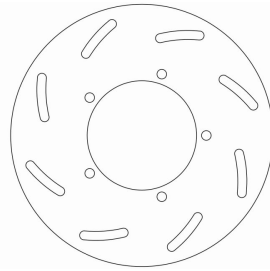
**FMD0211R**

Available

REAR

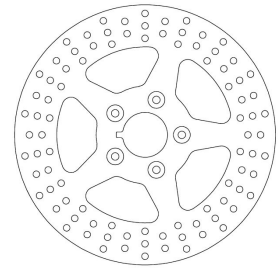

DIMENSIONS		
A	Outside Diam. mm	240
B	Inside Diam. mm	110
C	Thickness mm	5
D	Fixing Holes Number	6
E	Fixing Holes Diam. mm	6.5
F	Fixing Holes Centreline Diam. mm	124

DIMENSIONS		
A	Outside Diam. mm	175
B	Inside Diam. mm	73
C	Thickness mm	4
D	Fixing Holes Number	5
E	Fixing Holes Diam. mm	6.4
F	Fixing Holes Centreline Diam. mm	86

DIMENSIONS		
A	Outside Diam. mm	292
B	Inside Diam. mm	50.5
C	Thickness mm	5
D	Fixing Holes Number	5
E	Fixing Holes Diam. mm	10.5
F	Fixing Holes Centreline Diam. mm	82.5

FMD0211RF

Available

REAR

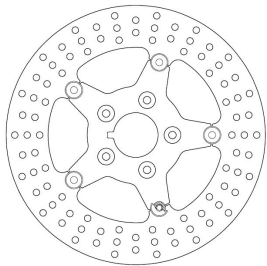
**FMD0211RPF**

Available

REAR

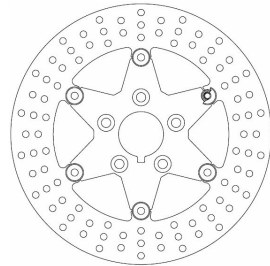
**FMD0212R**

Available

REAR

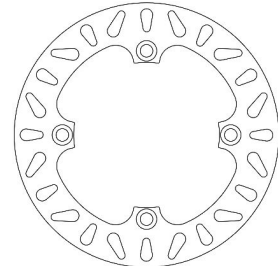

DIMENSIONS		
A	Outside Diam. mm	292
B	Inside Diam. mm	50.5
C	Thickness mm	5
D	Fixing Holes Number	5
E	Fixing Holes Diam. mm	10.5
F	Fixing Holes Centreline Diam. mm	82.5

DIMENSIONS		
A	Outside Diam. mm	292
B	Inside Diam. mm	50.5
C	Thickness mm	5
D	Fixing Holes Number	5
E	Fixing Holes Diam. mm	10.5
F	Fixing Holes Centreline Diam. mm	82.5

DIMENSIONS		
A	Outside Diam. mm	220
B	Inside Diam. mm	121.1
C	Thickness mm	5
D	Fixing Holes Number	4
E	Fixing Holes Diam. mm	10.5
F	Fixing Holes Centreline Diam. mm	140

For A,B,C,D,E,F see first page of this section

12022

FMD0214MXR

Available

REAR

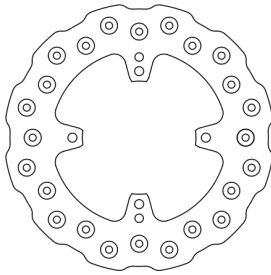
**FMD0216R**

Available

REAR

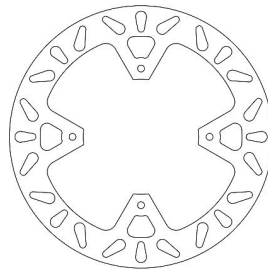
**FMD0217R**

Available

FRONT / REAR

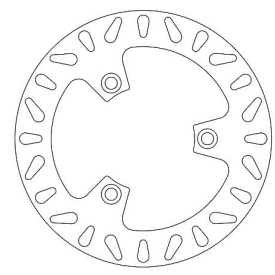
**DIMENSIONS**

A	Outside Diam. mm	190
B	Inside Diam. mm	80.2
C	Thickness mm	4
D	Fixing Holes Number	4
E	Fixing Holes Diam. mm	6.3
F	Fixing Holes Centreline Diam. mm	94

DIMENSIONS

A	Outside Diam. mm	240
B	Inside Diam. mm	105.2
C	Thickness mm	4
D	Fixing Holes Number	4
E	Fixing Holes Diam. mm	6.3
F	Fixing Holes Centreline Diam. mm	125

DIMENSIONS

A	Outside Diam. mm	220
B	Inside Diam. mm	88
C	Thickness mm	4
D	Fixing Holes Number	3
E	Fixing Holes Diam. mm	10.5
F	Fixing Holes Centreline Diam. mm	110

FMD0218R

Available

FRONT / REAR

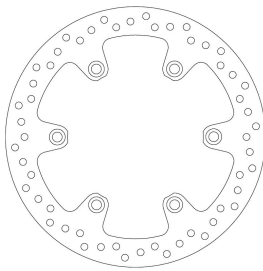
**FMD0220R**

Available

REAR

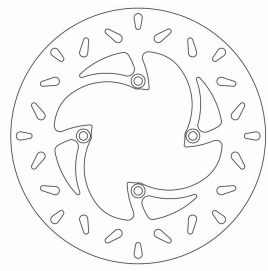
**FMD0221R**

Available

REAR

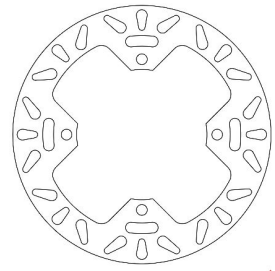
**DIMENSIONS**

A	Outside Diam. mm	280
B	Inside Diam. mm	130
C	Thickness mm	5
D	Fixing Holes Number	6
E	Fixing Holes Diam. mm	10.5
F	Fixing Holes Centreline Diam. mm	150

DIMENSIONS

A	Outside Diam. mm	256
B	Inside Diam. mm	94
C	Thickness mm	5
D	Fixing Holes Number	4
E	Fixing Holes Diam. mm	8.5
F	Fixing Holes Centreline Diam. mm	110

DIMENSIONS

A	Outside Diam. mm	240
B	Inside Diam. mm	121.1
C	Thickness mm	4
D	Fixing Holes Number	4
E	Fixing Holes Diam. mm	10
F	Fixing Holes Centreline Diam. mm	140

For A,B,C,D,E,F see first page of this section

FMD0224RX

Available

FRONT

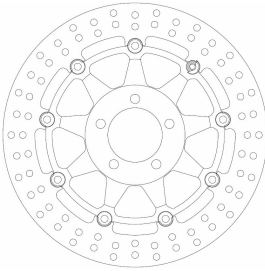
**FMD0225R**

Available

FRONT

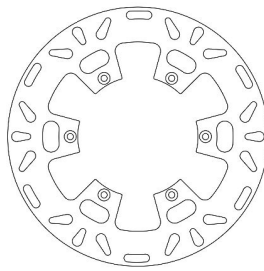
**FMD0227R**

Available

REAR

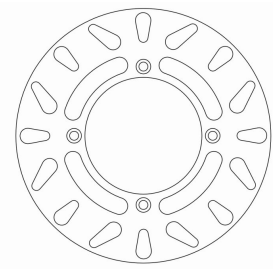
**DIMENSIONS**

A	Outside Diam. mm	296
B	Inside Diam. mm	61
C	Thickness mm	5
D	Fixing Holes Number	5
E	Fixing Holes Diam. mm	10.5
F	Fixing Holes Centreline Diam. mm	81

DIMENSIONS

A	Outside Diam. mm	260
B	Inside Diam. mm	120.1
C	Thickness mm	4
D	Fixing Holes Number	6
E	Fixing Holes Diam. mm	6.3
F	Fixing Holes Centreline Diam. mm	135

DIMENSIONS

A	Outside Diam. mm	184
B	Inside Diam. mm	84
C	Thickness mm	3
D	Fixing Holes Number	4
E	Fixing Holes Diam. mm	6.5
F	Fixing Holes Centreline Diam. mm	100

FMD0228R

Available

REAR

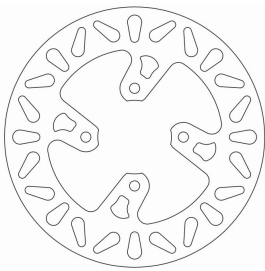
**FMD0229R**

Available

FRONT

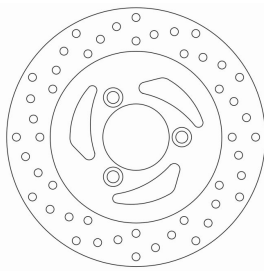
**FMD0233R**

Available

REAR

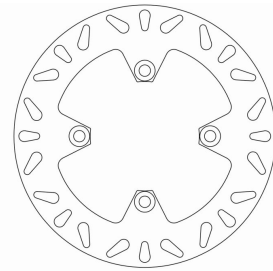
**DIMENSIONS**

A	Outside Diam. mm	160
B	Inside Diam. mm	45
C	Thickness mm	3
D	Fixing Holes Number	4
E	Fixing Holes Diam. mm	6.5
F	Fixing Holes Centreline Diam. mm	60

DIMENSIONS

A	Outside Diam. mm	226
B	Inside Diam. mm	58
C	Thickness mm	4
D	Fixing Holes Number	3
E	Fixing Holes Diam. mm	10.5
F	Fixing Holes Centreline Diam. mm	80

DIMENSIONS

A	Outside Diam. mm	238.5
B	Inside Diam. mm	102
C	Thickness mm	4.5
D	Fixing Holes Number	4
E	Fixing Holes Diam. mm	10.5
F	Fixing Holes Centreline Diam. mm	120

For A,B,C,D,E,F see first page of this section

12024**FERODO**

RACING

Updated on November 2020

FMD0234R

Available

REAR

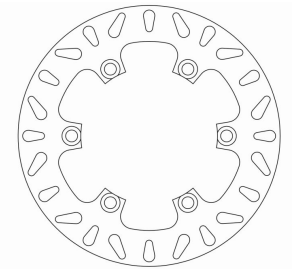
**FMD0237R**

Available

REAR

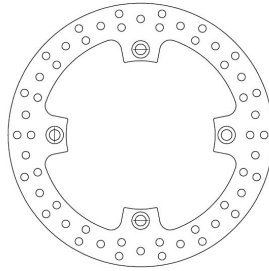
**FMD0238R**

Available

REAR

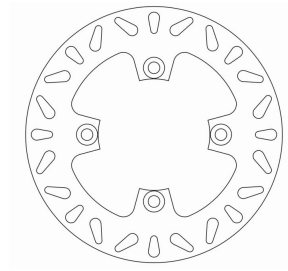
**DIMENSIONS**

A	Outside Diam. mm	230
B	Inside Diam. mm	120
C	Thickness mm	4
D	Fixing Holes Number	6
E	Fixing Holes Diam. mm	10.5
F	Fixing Holes Centreline Diam. mm	136

DIMENSIONS

A	Outside Diam. mm	218.5
B	Inside Diam. mm	102
C	Thickness mm	4
D	Fixing Holes Number	4
E	Fixing Holes Diam. mm	10.5
F	Fixing Holes Centreline Diam. mm	120

DIMENSIONS

A	Outside Diam. mm	230
B	Inside Diam. mm	100
C	Thickness mm	5
D	Fixing Holes Number	4
E	Fixing Holes Diam. mm	10.5
F	Fixing Holes Centreline Diam. mm	120

FMD0239MXR

Available

REAR

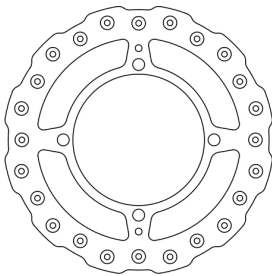
**FMD0241RX**

Available

FRONT

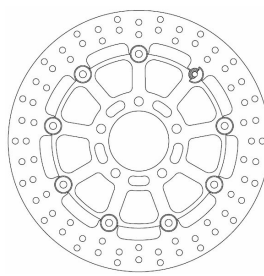
**FMD0242R**

Available

REAR

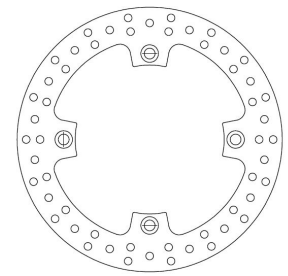
**DIMENSIONS**

A	Outside Diam. mm	240
B	Inside Diam. mm	115.1
C	Thickness mm	4
D	Fixing Holes Number	4
E	Fixing Holes Diam. mm	10.5
F	Fixing Holes Centreline Diam. mm	133

DIMENSIONS

A	Outside Diam. mm	300
B	Inside Diam. mm	69
C	Thickness mm	5
D	Fixing Holes Number	5
E	Fixing Holes Diam. mm	10.5
F	Fixing Holes Centreline Diam. mm	91

DIMENSIONS

A	Outside Diam. mm	218.5
B	Inside Diam. mm	118.5
C	Thickness mm	4
D	Fixing Holes Number	4
E	Fixing Holes Diam. mm	8.5
F	Fixing Holes Centreline Diam. mm	142

For A,B,C,D,E,F see first page of this section

FMD0244R

Available

FRONT / REAR

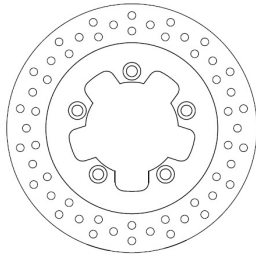
**FMD0246R**

Available

REAR

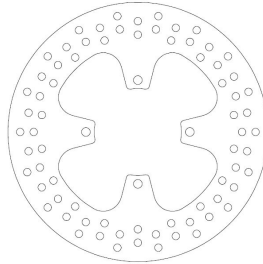
**FMD0247R**

Available

REAR

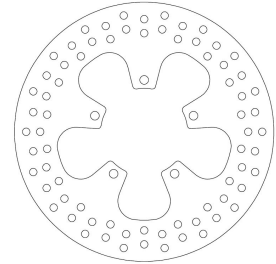
**DIMENSIONS**

A	Outside Diam. mm	240
B	Inside Diam. mm	89
C	Thickness mm	5
D	Fixing Holes Number	5
E	Fixing Holes Diam. mm	10.5
F	Fixing Holes Centreline Diam. mm	110

DIMENSIONS

A	Outside Diam. mm	250
B	Inside Diam. mm	84
C	Thickness mm	4
D	Fixing Holes Number	4
E	Fixing Holes Diam. mm	8.5
F	Fixing Holes Centreline Diam. mm	100

DIMENSIONS

A	Outside Diam. mm	250
B	Inside Diam. mm	84
C	Thickness mm	5
D	Fixing Holes Number	5
E	Fixing Holes Diam. mm	8.5
F	Fixing Holes Centreline Diam. mm	100

FMD0248MXR

Available

REAR

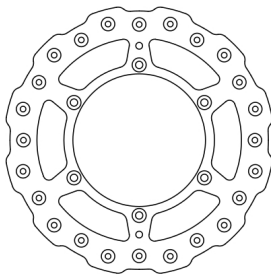
**FMD0249R**

Available

REAR

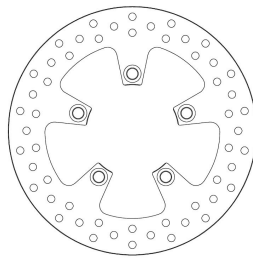
**FMD0250R**

Available

REAR

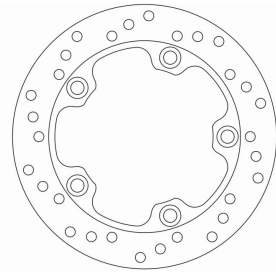
**DIMENSIONS**

A	Outside Diam. mm	240
B	Inside Diam. mm	118
C	Thickness mm	4
D	Fixing Holes Number	6
E	Fixing Holes Diam. mm	6.5
F	Fixing Holes Centreline Diam. mm	134

DIMENSIONS

A	Outside Diam. mm	220
B	Inside Diam. mm	89
C	Thickness mm	5
D	Fixing Holes Number	5
E	Fixing Holes Diam. mm	10.5
F	Fixing Holes Centreline Diam. mm	110

DIMENSIONS

A	Outside Diam. mm	210
B	Inside Diam. mm	109
C	Thickness mm	5
D	Fixing Holes Number	5
E	Fixing Holes Diam. mm	10.6
F	Fixing Holes Centreline Diam. mm	132

For A,B,C,D,E,F see first page of this section

12026**FERODO**

RACING

Updated on November 2020

FMD0251R

Exhausting

REAR

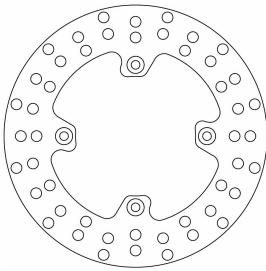
**FMD0256R**

Available

REAR

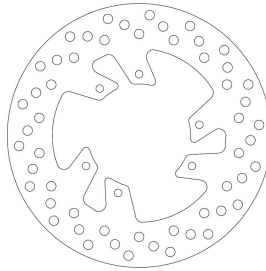
**FMD0257R**

Available

REAR

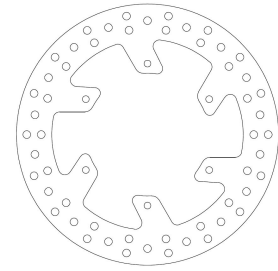
**DIMENSIONS**

A	Outside Diam. mm	184
B	Inside Diam. mm	84
C	Thickness mm	3.5
D	Fixing Holes Number	4
E	Fixing Holes Diam. mm	6.5
F	Fixing Holes Centreline Diam. mm	100

DIMENSIONS

A	Outside Diam. mm	220
B	Inside Diam. mm	86
C	Thickness mm	4.5
D	Fixing Holes Number	6
E	Fixing Holes Diam. mm	6.5
F	Fixing Holes Centreline Diam. mm	102

DIMENSIONS

A	Outside Diam. mm	245
B	Inside Diam. mm	115
C	Thickness mm	5
D	Fixing Holes Number	6
E	Fixing Holes Diam. mm	6.5
F	Fixing Holes Centreline Diam. mm	133

FMD0258R

Available

REAR

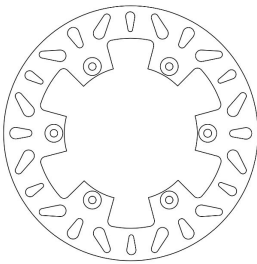
**FMD0261R**

Available

REAR

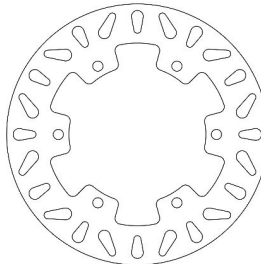
**FMD0263MXR**

Available

REAR

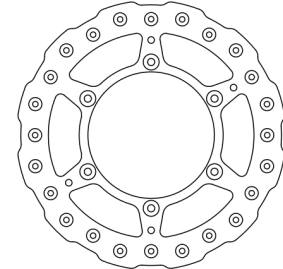
**DIMENSIONS**

A	Outside Diam. mm	240
B	Inside Diam. mm	115
C	Thickness mm	4
D	Fixing Holes Number	6
E	Fixing Holes Diam. mm	6.5
F	Fixing Holes Centreline Diam. mm	133

DIMENSIONS

A	Outside Diam. mm	220
B	Inside Diam. mm	115.1
C	Thickness mm	5
D	Fixing Holes Number	6
E	Fixing Holes Diam. mm	8.6
F	Fixing Holes Centreline Diam. mm	133

DIMENSIONS

A	Outside Diam. mm	245
B	Inside Diam. mm	115
C	Thickness mm	4
D	Fixing Holes Number	6
E	Fixing Holes Diam. mm	6.5
F	Fixing Holes Centreline Diam. mm	133

For A,B,C,D,E,F see first page of this section

FMD0265R

Available

REAR

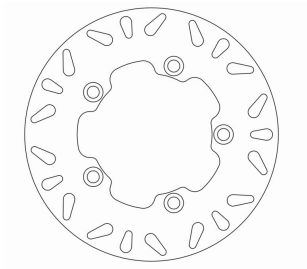
**FMD0266R**

Available

FRONT

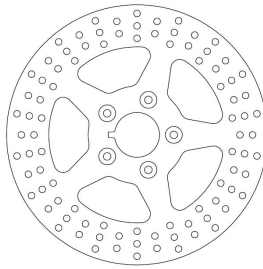
**FMD0266RF**

Available

FRONT

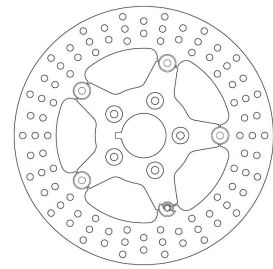
**DIMENSIONS**

A	Outside Diam. mm	220
B	Inside Diam. mm	105
C	Thickness mm	4
D	Fixing Holes Number	5
E	Fixing Holes Diam. mm	10.5
F	Fixing Holes Centreline Diam. mm	125

DIMENSIONS

A	Outside Diam. mm	292
B	Inside Diam. mm	56.3
C	Thickness mm	5
D	Fixing Holes Number	5
E	Fixing Holes Diam. mm	8.5
F	Fixing Holes Centreline Diam. mm	82.5

DIMENSIONS

A	Outside Diam. mm	292
B	Inside Diam. mm	56.3
C	Thickness mm	5
D	Fixing Holes Number	5
E	Fixing Holes Diam. mm	8.5
F	Fixing Holes Centreline Diam. mm	82.5

FMD0267R

Available

REAR

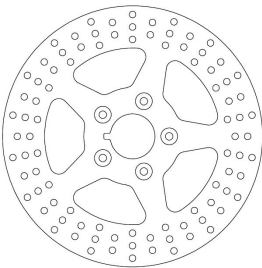
**FMD0267RF**

Available

REAR

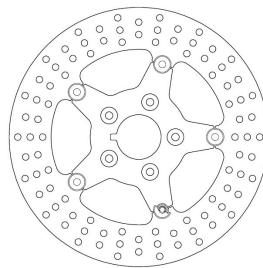
**FMD0271R**

Available

FRONT

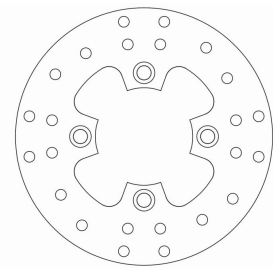
**DIMENSIONS**

A	Outside Diam. mm	292
B	Inside Diam. mm	56.3
C	Thickness mm	5
D	Fixing Holes Number	5
E	Fixing Holes Diam. mm	10.5
F	Fixing Holes Centreline Diam. mm	82.5

DIMENSIONS

A	Outside Diam. mm	292
B	Inside Diam. mm	56.3
C	Thickness mm	5
D	Fixing Holes Number	5
E	Fixing Holes Diam. mm	10.5
F	Fixing Holes Centreline Diam. mm	82.5

DIMENSIONS

A	Outside Diam. mm	187
B	Inside Diam. mm	72
C	Thickness mm	4
D	Fixing Holes Number	4
E	Fixing Holes Diam. mm	10.5
F	Fixing Holes Centreline Diam. mm	94

For A,B,C,D,E,F see first page of this section

12028**FERODO**

RACING

Updated on November 2020

FMD0274R

Available

REAR

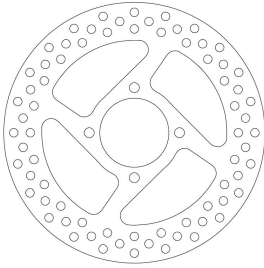
**FMD0275RF**

Available

FRONT

October 2015:RPF Superseded by RF

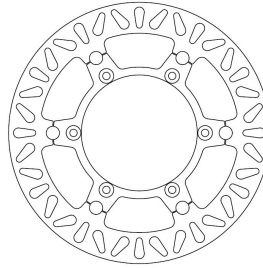
**FMD0279RF**

Available

FRONT

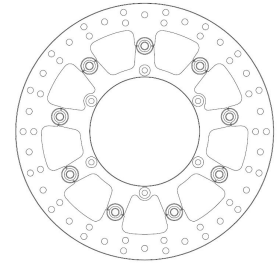
**DIMENSIONS**

A	Outside Diam. mm	220
B	Inside Diam. mm	58.3
C	Thickness mm	4
D	Fixing Holes Number	4
E	Fixing Holes Diam. mm	8.5
F	Fixing Holes Centreline Diam. mm	76

DIMENSIONS

A	Outside Diam. mm	298
B	Inside Diam. mm	132
C	Thickness mm	5
D	Fixing Holes Number	6
E	Fixing Holes Diam. mm	10.5
F	Fixing Holes Centreline Diam. mm	150

DIMENSIONS

A	Outside Diam. mm	300
B	Inside Diam. mm	127
C	Thickness mm	4
D	Fixing Holes Number	6
E	Fixing Holes Diam. mm	6.5
F	Fixing Holes Centreline Diam. mm	143

FMD0281RX

Available

FRONT

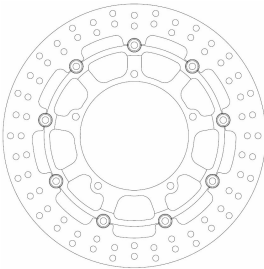
**FMD0312R**

Available

REAR

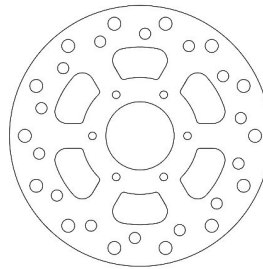
**FMD0315R**

Available

FRONT

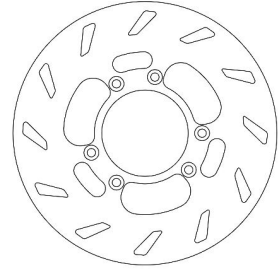
**DIMENSIONS**

A	Outside Diam. mm	320
B	Inside Diam. mm	132
C	Thickness mm	5
D	Fixing Holes Number	5
E	Fixing Holes Diam. mm	8.5
F	Fixing Holes Centreline Diam. mm	150

DIMENSIONS

A	Outside Diam. mm	220
B	Inside Diam. mm	57.5
C	Thickness mm	4
D	Fixing Holes Number	6
E	Fixing Holes Diam. mm	6.5
F	Fixing Holes Centreline Diam. mm	80.1

DIMENSIONS

A	Outside Diam. mm	220
B	Inside Diam. mm	72.1
C	Thickness mm	3.5
D	Fixing Holes Number	6
E	Fixing Holes Diam. mm	7
F	Fixing Holes Centreline Diam. mm	95.2

For A,B,C,D,E,F see first page of this section

FMD0317R

Available

REAR

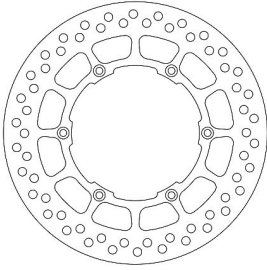
**FMD0318R**

Available

REAR

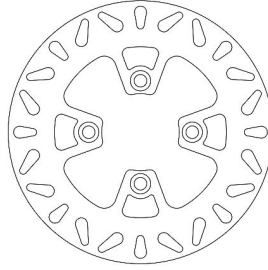
**FMD0319R**

Available

FRONT

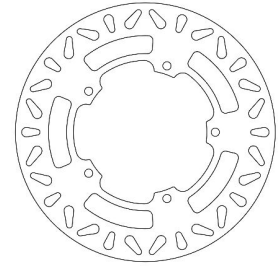
**DIMENSIONS**

A	Outside Diam. mm	245
B	Inside Diam. mm	118.7
C	Thickness mm	3
D	Fixing Holes Number	6
E	Fixing Holes Diam. mm	6.5
F	Fixing Holes Centreline Diam. mm	134

DIMENSIONS

A	Outside Diam. mm	220
B	Inside Diam. mm	64.5
C	Thickness mm	4
D	Fixing Holes Number	4
E	Fixing Holes Diam. mm	10.5
F	Fixing Holes Centreline Diam. mm	86.1

DIMENSIONS

A	Outside Diam. mm	270
B	Inside Diam. mm	128.2
C	Thickness mm	5
D	Fixing Holes Number	5
E	Fixing Holes Diam. mm	8.6
F	Fixing Holes Centreline Diam. mm	146

FMD0320R

Available

REAR

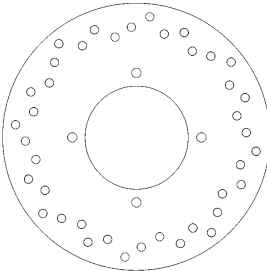
**FMD0323R**

Available

FRONT / REAR

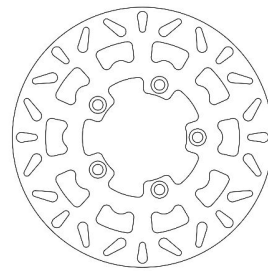
**FMD0324R**

Available

FRONT

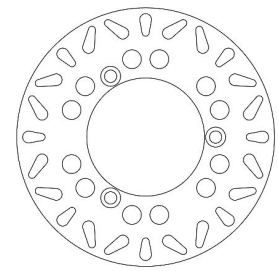
**DIMENSIONS**

A	Outside Diam. mm	240
B	Inside Diam. mm	92.5
C	Thickness mm	5
D	Fixing Holes Number	4
E	Fixing Holes Diam. mm	8.6
F	Fixing Holes Centreline Diam. mm	114

DIMENSIONS

A	Outside Diam. mm	260
B	Inside Diam. mm	88.1
C	Thickness mm	4
D	Fixing Holes Number	5
E	Fixing Holes Diam. mm	10.5
F	Fixing Holes Centreline Diam. mm	110.1

DIMENSIONS

A	Outside Diam. mm	220
B	Inside Diam. mm	100.5
C	Thickness mm	4
D	Fixing Holes Number	3
E	Fixing Holes Diam. mm	10.5
F	Fixing Holes Centreline Diam. mm	119.5

For A,B,C,D,E,F see first page of this section

12030**FERODO**

RACING

Updated on November 2020

FMD0325R

Available

REAR

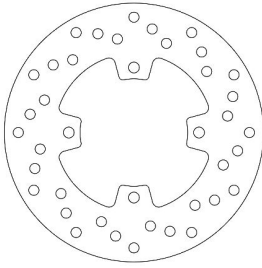
**FMD0326R**

Available

FRONT

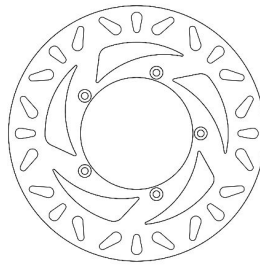
**FMD0327R**

Available

REAR

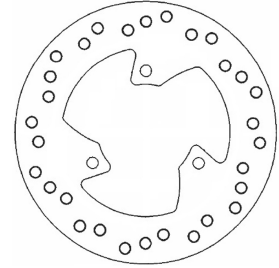
**DIMENSIONS**

A	Outside Diam. mm	203
B	Inside Diam. mm	84.3
C	Thickness mm	4.5
D	Fixing Holes Number	4
E	Fixing Holes Diam. mm	8.5
F	Fixing Holes Centreline Diam. mm	102

DIMENSIONS

A	Outside Diam. mm	240
B	Inside Diam. mm	105.2
C	Thickness mm	5
D	Fixing Holes Number	5
E	Fixing Holes Diam. mm	6.4
F	Fixing Holes Centreline Diam. mm	120.5

DIMENSIONS

A	Outside Diam. mm	189.5
B	Inside Diam. mm	69.5
C	Thickness mm	4
D	Fixing Holes Number	3
E	Fixing Holes Diam. mm	8.4
F	Fixing Holes Centreline Diam. mm	88.7

FMD0328R

Available

FRONT

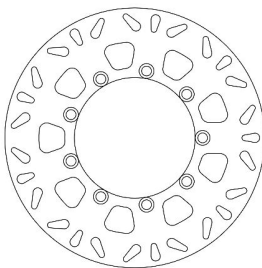
**FMD0330R**

Available

FRONT

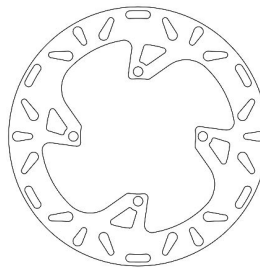
**FMD0332R**

Available

FRONT

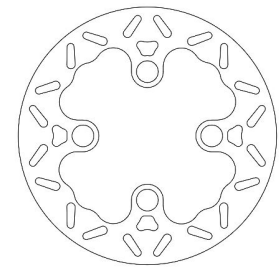
**DIMENSIONS**

A	Outside Diam. mm	280
B	Inside Diam. mm	130.1
C	Thickness mm	5
D	Fixing Holes Number	9
E	Fixing Holes Diam. mm	10.6
F	Fixing Holes Centreline Diam. mm	146.3

DIMENSIONS

A	Outside Diam. mm	270
B	Inside Diam. mm	120.2
C	Thickness mm	3
D	Fixing Holes Number	4
E	Fixing Holes Diam. mm	10
F	Fixing Holes Centreline Diam. mm	135

DIMENSIONS

A	Outside Diam. mm	185
B	Inside Diam. mm	69.4
C	Thickness mm	3
D	Fixing Holes Number	4
E	Fixing Holes Diam. mm	15.6
F	Fixing Holes Centreline Diam. mm	92

For A,B,C,D,E,F see first page of this section

FMD0333R

Available

REAR

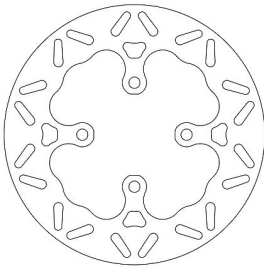
**FMD0334R**

Available

FRONT

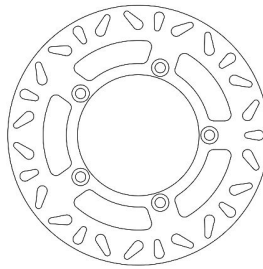
**FMD0335R**

Available

REAR

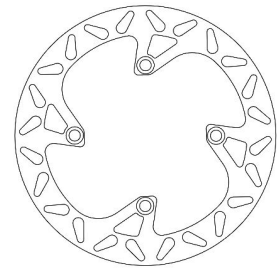
**DIMENSIONS**

A	Outside Diam. mm	150
B	Inside Diam. mm	46.9
C	Thickness mm	3
D	Fixing Holes Number	4
E	Fixing Holes Diam. mm	6.5
F	Fixing Holes Centreline Diam. mm	60

DIMENSIONS

A	Outside Diam. mm	260
B	Inside Diam. mm	121.2
C	Thickness mm	4.4
D	Fixing Holes Number	5
E	Fixing Holes Diam. mm	10.3
F	Fixing Holes Centreline Diam. mm	141.9

DIMENSIONS

A	Outside Diam. mm	240
B	Inside Diam. mm	112.5
C	Thickness mm	4
D	Fixing Holes Number	4
E	Fixing Holes Diam. mm	10.4
F	Fixing Holes Centreline Diam. mm	130

FMD0342R

Available

REAR

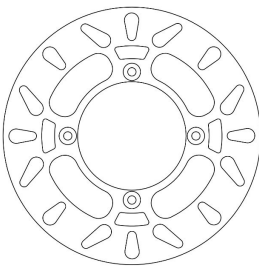
**FMD0349RX**

Available

FRONT

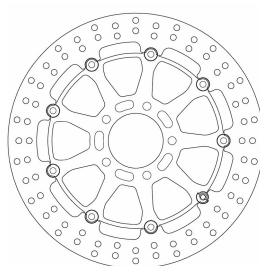
**FMD0350RX**

Available

FRONT

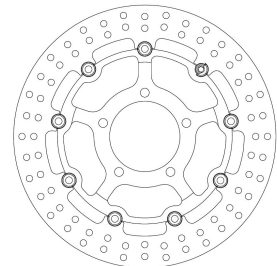
**DIMENSIONS**

A	Outside Diam. mm	200
B	Inside Diam. mm	84.5
C	Thickness mm	3
D	Fixing Holes Number	4
E	Fixing Holes Diam. mm	6.5
F	Fixing Holes Centreline Diam. mm	100

DIMENSIONS

A	Outside Diam. mm	290
B	Inside Diam. mm	69
C	Thickness mm	5
D	Fixing Holes Number	5
E	Fixing Holes Diam. mm	10.5
F	Fixing Holes Centreline Diam. mm	91

DIMENSIONS

A	Outside Diam. mm	300
B	Inside Diam. mm	80.5
C	Thickness mm	5
D	Fixing Holes Number	5
E	Fixing Holes Diam. mm	10.5
F	Fixing Holes Centreline Diam. mm	100

For A,B,C,D,E,F see first page of this section

12032**FERODO**

RACING

Updated on November 2020

FMD0352RX

Available

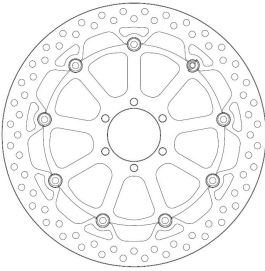
FRONT**FMD0353R**

Available

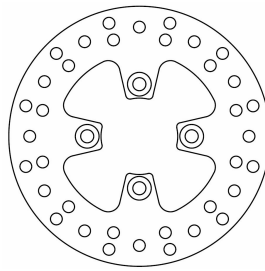
FRONT**FMD0361R**

Available

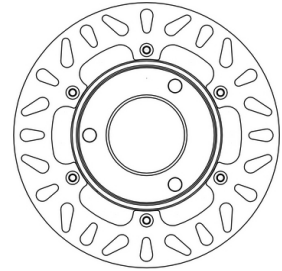
REAR**DIMENSIONS**

A	Outside Diam. mm	320
B	Inside Diam. mm	64
C	Thickness mm	5
D	Fixing Holes Number	6
E	Fixing Holes Diam. mm	8.5
F	Fixing Holes Centreline Diam. mm	80

DIMENSIONS

A	Outside Diam. mm	165
B	Inside Diam. mm	48.5
C	Thickness mm	4
D	Fixing Holes Number	4
E	Fixing Holes Diam. mm	8.3
F	Fixing Holes Centreline Diam. mm	66

DIMENSIONS

A	Outside Diam. mm	210
B	Inside Diam. mm	120.2
C	Thickness mm	5
D	Fixing Holes Number	6
E	Fixing Holes Diam. mm	6.2
F	Fixing Holes Centreline Diam. mm	135

FMD0362R

Available

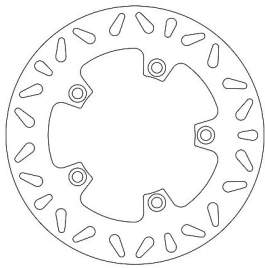
REAR**FMD0363R**

Available

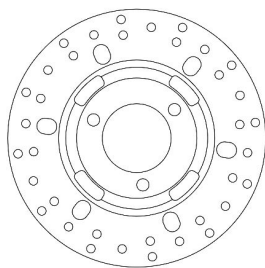
FRONT**FMD0365R**

Available

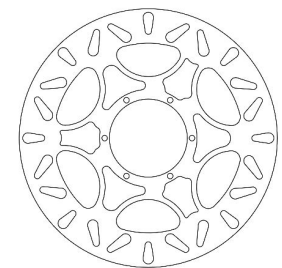
FRONT**DIMENSIONS**

A	Outside Diam. mm	250
B	Inside Diam. mm	116.6
C	Thickness mm	5.5
D	Fixing Holes Number	5
E	Fixing Holes Diam. mm	10.3
F	Fixing Holes Centreline Diam. mm	137.3

DIMENSIONS

A	Outside Diam. mm	180
B	Inside Diam. mm	48
C	Thickness mm	4
D	Fixing Holes Number	3
E	Fixing Holes Diam. mm	8.6
F	Fixing Holes Centreline Diam. mm	66

DIMENSIONS

A	Outside Diam. mm	300
B	Inside Diam. mm	90.5
C	Thickness mm	4
D	Fixing Holes Number	6
E	Fixing Holes Diam. mm	6.5
F	Fixing Holes Centreline Diam. mm	101.6

For A,B,C,D,E,F see first page of this section

FMD0366MXR

Available

REAR

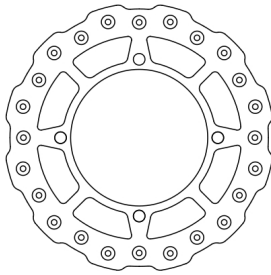
**FMD0367R**

Available

FRONT / REAR

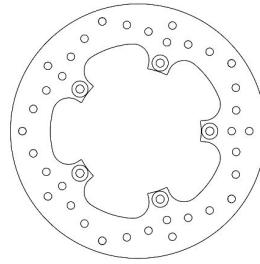
**FMD0369R**

Available

FRONT

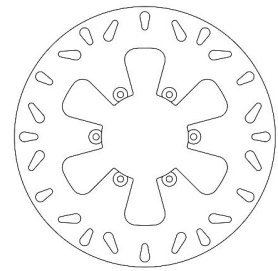
**DIMENSIONS**

A	Outside Diam. mm	240
B	Inside Diam. mm	122.2
C	Thickness mm	4
D	Fixing Holes Number	4
E	Fixing Holes Diam. mm	10
F	Fixing Holes Centreline Diam. mm	140

DIMENSIONS

A	Outside Diam. mm	267
B	Inside Diam. mm	132.2
C	Thickness mm	5
D	Fixing Holes Number	5
E	Fixing Holes Diam. mm	8.6
F	Fixing Holes Centreline Diam. mm	150.2

DIMENSIONS

A	Outside Diam. mm	270
B	Inside Diam. mm	90.1
C	Thickness mm	5
D	Fixing Holes Number	6
E	Fixing Holes Diam. mm	6.5
F	Fixing Holes Centreline Diam. mm	101

FMD0371R

Available

FRONT / REAR

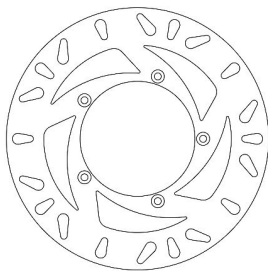
**FMD0375R**

Available

FRONT

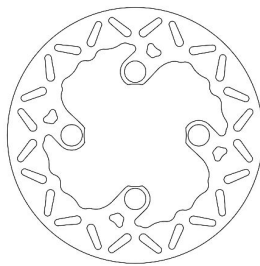
**FMD0377R**

Available

FRONT

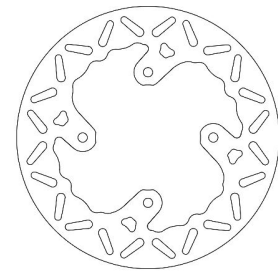
**DIMENSIONS**

A	Outside Diam. mm	240
B	Inside Diam. mm	105.2
C	Thickness mm	4
D	Fixing Holes Number	5
E	Fixing Holes Diam. mm	6.4
F	Fixing Holes Centreline Diam. mm	120

DIMENSIONS

A	Outside Diam. mm	185
B	Inside Diam. mm	74
C	Thickness mm	3
D	Fixing Holes Number	4
E	Fixing Holes Diam. mm	15.5
F	Fixing Holes Centreline Diam. mm	92

DIMENSIONS

A	Outside Diam. mm	185
B	Inside Diam. mm	74
C	Thickness mm	3
D	Fixing Holes Number	4
E	Fixing Holes Diam. mm	6.6
F	Fixing Holes Centreline Diam. mm	92

For A,B,C,D,E,F see first page of this section

12034**FERODO**

RACING

Updated on November 2020

FMD0378R

Available

REAR

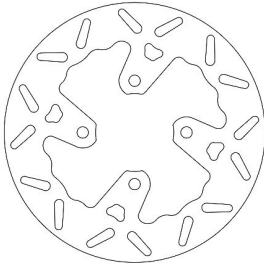
**FMD0381R**

Available

FRONT

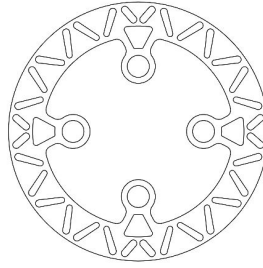
**FMD0382R**

Available

REAR

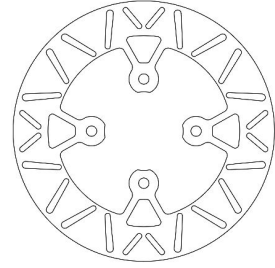
**DIMENSIONS**

A	Outside Diam. mm	150
B	Inside Diam. mm	45.2
C	Thickness mm	3
D	Fixing Holes Number	4
E	Fixing Holes Diam. mm	6.6
F	Fixing Holes Centreline Diam. mm	60

DIMENSIONS

A	Outside Diam. mm	183
B	Inside Diam. mm	68
C	Thickness mm	3
D	Fixing Holes Number	4
E	Fixing Holes Diam. mm	16
F	Fixing Holes Centreline Diam. mm	92

DIMENSIONS

A	Outside Diam. mm	144
B	Inside Diam. mm	45.2
C	Thickness mm	3
D	Fixing Holes Number	4
E	Fixing Holes Diam. mm	6
F	Fixing Holes Centreline Diam. mm	60

FMD0389R

Available

REAR

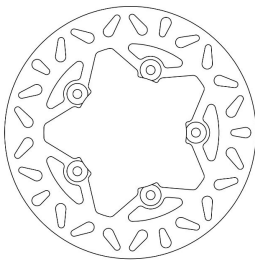
**FMD0390R**

Available

REAR

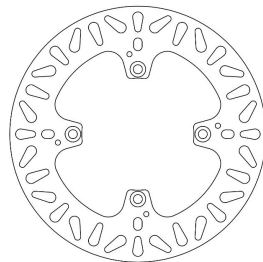
**FMD0393RX**

Available

FRONT

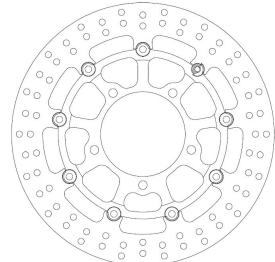
**DIMENSIONS**

A	Outside Diam. mm	240
B	Inside Diam. mm	107
C	Thickness mm	4
D	Fixing Holes Number	5
E	Fixing Holes Diam. mm	8.5
F	Fixing Holes Centreline Diam. mm	125

DIMENSIONS

A	Outside Diam. mm	245
B	Inside Diam. mm	108.3
C	Thickness mm	5
D	Fixing Holes Number	4
E	Fixing Holes Diam. mm	8.5
F	Fixing Holes Centreline Diam. mm	125

DIMENSIONS

A	Outside Diam. mm	310
B	Inside Diam. mm	100
C	Thickness mm	5
D	Fixing Holes Number	5
E	Fixing Holes Diam. mm	10.5
F	Fixing Holes Centreline Diam. mm	120

For A,B,C,D,E,F see first page of this section

FMD0394RX

Available

FRONT

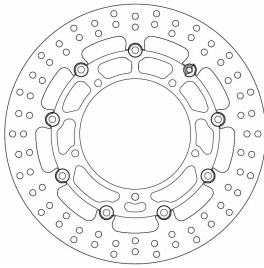
**FMD0396MXR**

Available

FRONT

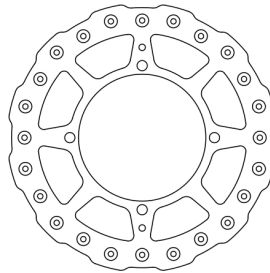
**FMD0397R**

Available

FRONT

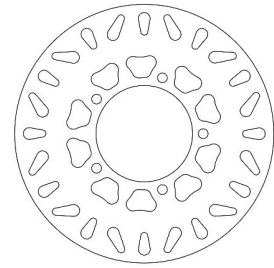
**DIMENSIONS**

A	Outside Diam. mm	310
B	Inside Diam. mm	132
C	Thickness mm	5
D	Fixing Holes Number	5
E	Fixing Holes Diam. mm	8.5
F	Fixing Holes Centreline Diam. mm	150

DIMENSIONS

A	Outside Diam. mm	250
B	Inside Diam. mm	118.2
C	Thickness mm	3
D	Fixing Holes Number	4
E	Fixing Holes Diam. mm	9.3
F	Fixing Holes Centreline Diam. mm	134

DIMENSIONS

A	Outside Diam. mm	220
B	Inside Diam. mm	82
C	Thickness mm	4
D	Fixing Holes Number	5
E	Fixing Holes Diam. mm	8.3
F	Fixing Holes Centreline Diam. mm	100

FMD0398R

Available

FRONT

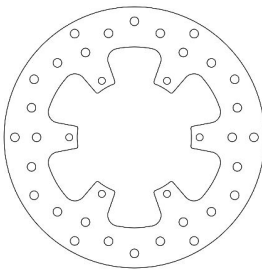
**DIMENSIONS**

A	Outside Diam. mm	240
B	Inside Diam. mm	105
C	Thickness mm	4
D	Fixing Holes Number	6
E	Fixing Holes Diam. mm	6.5
F	Fixing Holes Centreline Diam. mm	120

FMD0399R

Available

FRONT

MXR version TH = 4mm

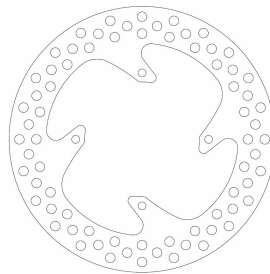
**DIMENSIONS**

A	Outside Diam. mm	220
B	Inside Diam. mm	95
C	Thickness mm	3/4
D	Fixing Holes Number	4
E	Fixing Holes Diam. mm	6.2
F	Fixing Holes Centreline Diam. mm	110

FMD0399MXR

Available

FRONT

MXR version TH = 4mm

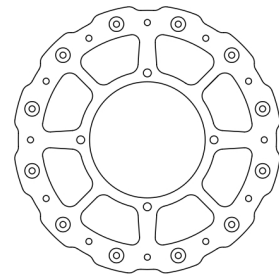
**DIMENSIONS**

A	Outside Diam. mm	220
B	Inside Diam. mm	95
C	Thickness mm	3/4
D	Fixing Holes Number	4
E	Fixing Holes Diam. mm	6.2
F	Fixing Holes Centreline Diam. mm	110

For A,B,C,D,E,F see first page of this section

12036**FERODO**

RACING

Updated on November 2020

FMD0400R

Available

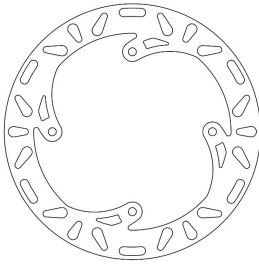
REAR**FMD0401RX**

Available

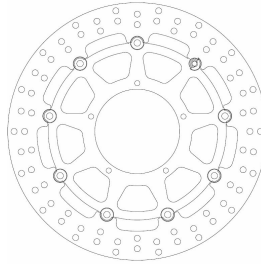
FRONT**FMD0403R**

Available

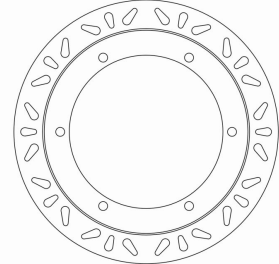
REAR**DIMENSIONS**

A	Outside Diam. mm	200
B	Inside Diam. mm	110
C	Thickness mm	3
D	Fixing Holes Number	4
E	Fixing Holes Diam. mm	6.2
F	Fixing Holes Centreline Diam. mm	124.5

DIMENSIONS

A	Outside Diam. mm	320
B	Inside Diam. mm	105
C	Thickness mm	5
D	Fixing Holes Number	5
E	Fixing Holes Diam. mm	6.5
F	Fixing Holes Centreline Diam. mm	120

DIMENSIONS

A	Outside Diam. mm	316
B	Inside Diam. mm	184.2
C	Thickness mm	7.5
D	Fixing Holes Number	6
E	Fixing Holes Diam. mm	10.7
F	Fixing Holes Centreline Diam. mm	206

FMD0404R

Available

FRONT**FMD0405R**

Available

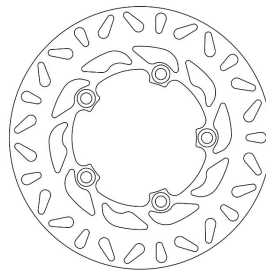
REAR**FMD0406R**

Available

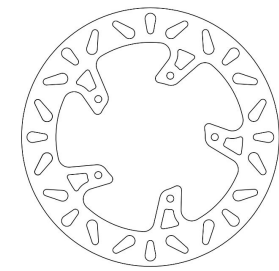
REAR**DIMENSIONS**

A	Outside Diam. mm	240
B	Inside Diam. mm	124
C	Thickness mm	3
D	Fixing Holes Number	6
E	Fixing Holes Diam. mm	6.5
F	Fixing Holes Centreline Diam. mm	138

DIMENSIONS

A	Outside Diam. mm	245
B	Inside Diam. mm	105
C	Thickness mm	5
D	Fixing Holes Number	5
E	Fixing Holes Diam. mm	10.5
F	Fixing Holes Centreline Diam. mm	125

DIMENSIONS

A	Outside Diam. mm	240
B	Inside Diam. mm	102
C	Thickness mm	4
D	Fixing Holes Number	5
E	Fixing Holes Diam. mm	6.5
F	Fixing Holes Centreline Diam. mm	120

For A,B,C,D,E,F see first page of this section

FMD0407R

Available

REAR

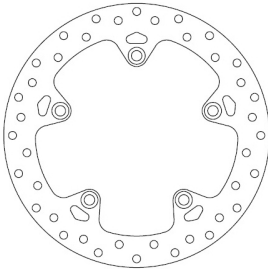
**FMD0409R**

Available

FRONT / REAR

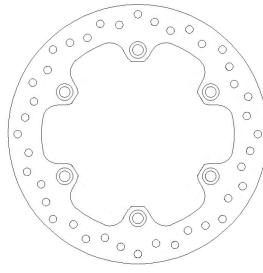
**FMD0410RX**

Available

FRONT

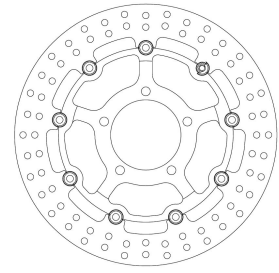
**DIMENSIONS**

A	Outside Diam. mm	265
B	Inside Diam. mm	136.5
C	Thickness mm	5
D	Fixing Holes Number	5
E	Fixing Holes Diam. mm	10.5
F	Fixing Holes Centreline Diam. mm	160

DIMENSIONS

A	Outside Diam. mm	256
B	Inside Diam. mm	144.4
C	Thickness mm	5
D	Fixing Holes Number	6
E	Fixing Holes Diam. mm	10.5
F	Fixing Holes Centreline Diam. mm	166

DIMENSIONS

A	Outside Diam. mm	310
B	Inside Diam. mm	80.5
C	Thickness mm	5
D	Fixing Holes Number	5
E	Fixing Holes Diam. mm	10.5
F	Fixing Holes Centreline Diam. mm	100

FMD0411RX

Available

FRONT

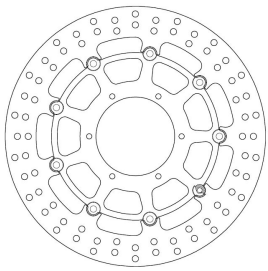
**FMD0412RX**

Available

FRONT

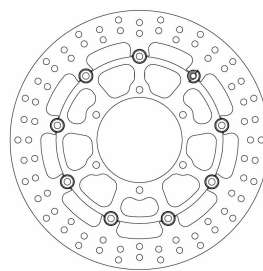
**FMD0413R**

Available

REAR

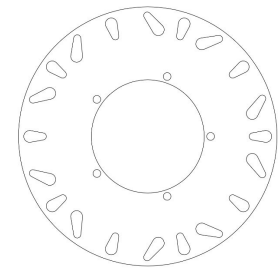
**DIMENSIONS**

A	Outside Diam. mm	320
B	Inside Diam. mm	94
C	Thickness mm	5
D	Fixing Holes Number	6
E	Fixing Holes Diam. mm	6.5
F	Fixing Holes Centreline Diam. mm	110

DIMENSIONS

A	Outside Diam. mm	310
B	Inside Diam. mm	102
C	Thickness mm	5
D	Fixing Holes Number	6
E	Fixing Holes Diam. mm	8.15
F	Fixing Holes Centreline Diam. mm	120

DIMENSIONS

A	Outside Diam. mm	220
B	Inside Diam. mm	96.1
C	Thickness mm	4
D	Fixing Holes Number	5
E	Fixing Holes Diam. mm	6.6
F	Fixing Holes Centreline Diam. mm	107

For A,B,C,D,E,F see first page of this section

12038**FERODO**

RACING

Updated on November 2020

FMD0415R

Available

FRONT

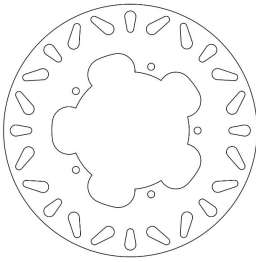
**FMD0416R**

Available

FRONT

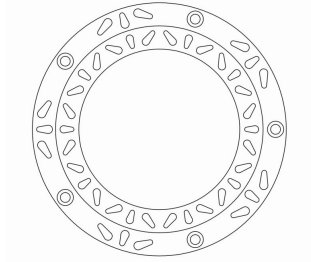
**FMD0417R**

Available

FRONT

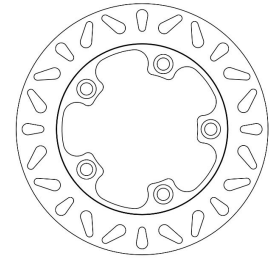
**DIMENSIONS**

A	Outside Diam. mm	226
B	Inside Diam. mm	105
C	Thickness mm	4
D	Fixing Holes Number	5
E	Fixing Holes Diam. mm	6.3
F	Fixing Holes Centreline Diam. mm	120

DIMENSIONS

A	Outside Diam. mm	273
B	Inside Diam. mm	173.1
C	Thickness mm	4
D	Fixing Holes Number	5
E	Fixing Holes Diam. mm	10.6
F	Fixing Holes Centreline Diam. mm	250

DIMENSIONS

A	Outside Diam. mm	220
B	Inside Diam. mm	97.2
C	Thickness mm	4
D	Fixing Holes Number	5
E	Fixing Holes Diam. mm	10.8
F	Fixing Holes Centreline Diam. mm	120

FMD0418R

Available

REAR

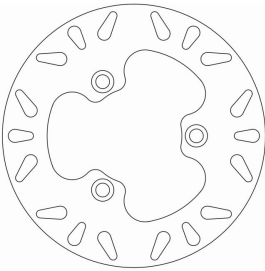
**FMD0419R**

Available

REAR

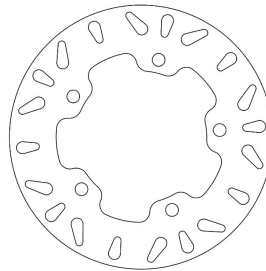
**FMD0420R**

Available

FRONT

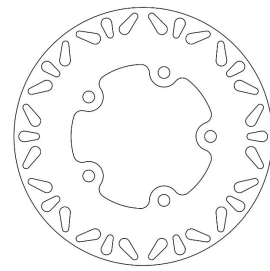
**DIMENSIONS**

A	Outside Diam. mm	200
B	Inside Diam. mm	73
C	Thickness mm	4
D	Fixing Holes Number	3
E	Fixing Holes Diam. mm	10.5
F	Fixing Holes Centreline Diam. mm	95

DIMENSIONS

A	Outside Diam. mm	220
B	Inside Diam. mm	110
C	Thickness mm	5
D	Fixing Holes Number	5
E	Fixing Holes Diam. mm	10.7
F	Fixing Holes Centreline Diam. mm	132

DIMENSIONS

A	Outside Diam. mm	240
B	Inside Diam. mm	98
C	Thickness mm	4
D	Fixing Holes Number	5
E	Fixing Holes Diam. mm	11
F	Fixing Holes Centreline Diam. mm	125

For A,B,C,D,E,F see first page of this section

FMD0421R

Available

REAR

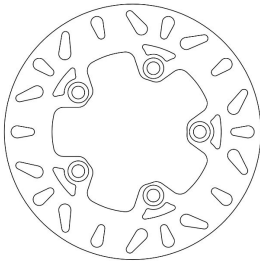
**FMD0422RF**

Available

FRONT

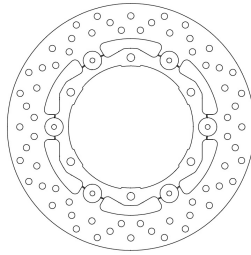
**FMD0423R**

Available

FRONT

2016: Outline drawing changed

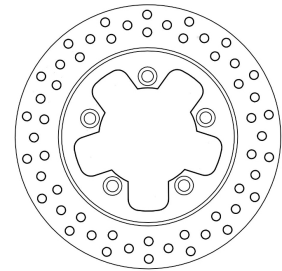
**DIMENSIONS**

A	Outside Diam. mm	210
B	Inside Diam. mm	89.2
C	Thickness mm	5
D	Fixing Holes Number	5
E	Fixing Holes Diam. mm	10.4
F	Fixing Holes Centreline Diam. mm	110

DIMENSIONS

A	Outside Diam. mm	267
B	Inside Diam. mm	132.1
C	Thickness mm	4
D	Fixing Holes Number	6
E	Fixing Holes Diam. mm	8.6
F	Fixing Holes Centreline Diam. mm	150

DIMENSIONS

A	Outside Diam. mm	240
B	Inside Diam. mm	88.1
C	Thickness mm	4
D	Fixing Holes Number	5
E	Fixing Holes Diam. mm	10.6
F	Fixing Holes Centreline Diam. mm	110

FMD0424R

Available

FRONT

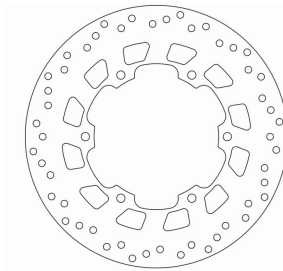
**FMD0425R**

Available

FRONT / REAR

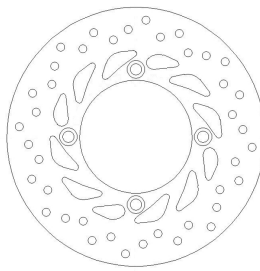
**FMD0427R**

Available

FRONT

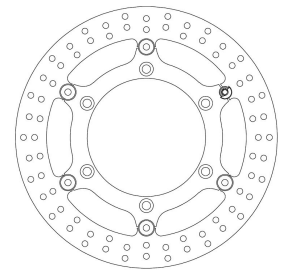
**DIMENSIONS**

A	Outside Diam. mm	270
B	Inside Diam. mm	128.3
C	Thickness mm	5
D	Fixing Holes Number	6
E	Fixing Holes Diam. mm	8.6
F	Fixing Holes Centreline Diam. mm	146.2

DIMENSIONS

A	Outside Diam. mm	240
B	Inside Diam. mm	105.1
C	Thickness mm	4
D	Fixing Holes Number	4
E	Fixing Holes Diam. mm	10.5
F	Fixing Holes Centreline Diam. mm	125.1

DIMENSIONS

A	Outside Diam. mm	318
B	Inside Diam. mm	144
C	Thickness mm	5
D	Fixing Holes Number	6
E	Fixing Holes Diam. mm	10.5
F	Fixing Holes Centreline Diam. mm	166

For A,B,C,D,E,F see first page of this section

12040**FERODO**

RACING

Updated on November 2020

FMD0430R

Available

FRONT

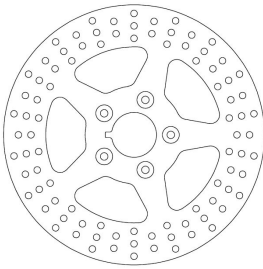
**FMD0431R**

Available

FRONT

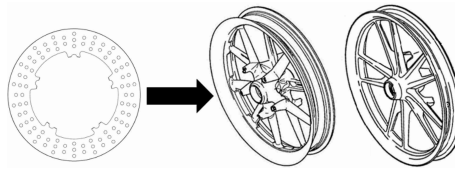
**FMD0433R**

Available

REAR

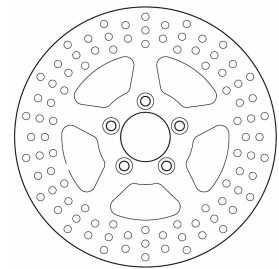

DIMENSIONS		
A	Outside Diam. mm	300
B	Inside Diam. mm	56.30
C	Thickness mm	5
D	Fixing Holes Number	5
E	Fixing Holes Diam. mm	8.5
F	Fixing Holes Centreline Diam. mm	82.5

DIMENSIONS		
A	Outside Diam. mm	300
B	Inside Diam. mm	172.5
C	Thickness mm	5
D	Fixing Holes Number	5
E	Fixing Holes Diam. mm	13.5
F	Fixing Holes Centreline Diam. mm	172.5

DIMENSIONS		
A	Outside Diam. mm	300
B	Inside Diam. mm	56.3
C	Thickness mm	6
D	Fixing Holes Number	5
E	Fixing Holes Diam. mm	10.5
F	Fixing Holes Centreline Diam. mm	82.5

FMD0435R

Available

FRONT

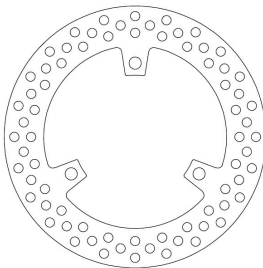
**FMD0436R**

Available

REAR

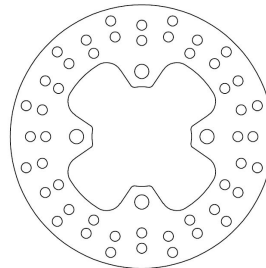
**FMD0437R**

Available

FRONT

RF-floating discs for Vehicles from 400cc

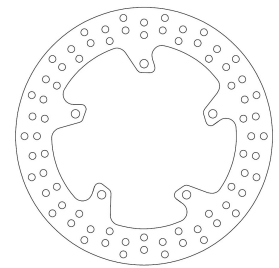

DIMENSIONS		
A	Outside Diam. mm	220
B	Inside Diam. mm	104
C	Thickness mm	4
D	Fixing Holes Number	3
E	Fixing Holes Diam. mm	10.5
F	Fixing Holes Centreline Diam. mm	124

DIMENSIONS		
A	Outside Diam. mm	190
B	Inside Diam. mm	72
C	Thickness mm	3.5
D	Fixing Holes Number	4
E	Fixing Holes Diam. mm	10.5
F	Fixing Holes Centreline Diam. mm	94

DIMENSIONS		
A	Outside Diam. mm	267
B	Inside Diam. mm	132
C	Thickness mm	4
D	Fixing Holes Number	5
E	Fixing Holes Diam. mm	9
F	Fixing Holes Centreline Diam. mm	150

For A,B,C,D,E,F see first page of this section

FMD0437RF

Available

FRONT

RF-floating discs for Vehicles from 400cc

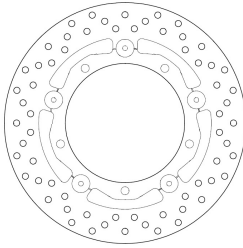
**FMD0439RF**

Available

FRONT

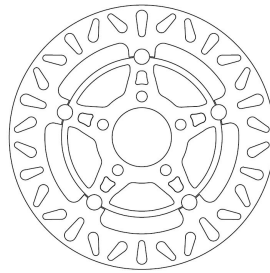
**FMD0440R**

Available

FRONT

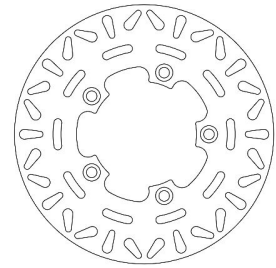
**DIMENSIONS**

A	Outside Diam. mm	267
B	Inside Diam. mm	132
C	Thickness mm	4
D	Fixing Holes Number	5
E	Fixing Holes Diam. mm	9
F	Fixing Holes Centreline Diam. mm	150

DIMENSIONS

A	Outside Diam. mm	260
B	Inside Diam. mm	58.1
C	Thickness mm	4
D	Fixing Holes Number	5
E	Fixing Holes Diam. mm	10.6
F	Fixing Holes Centreline Diam. mm	80

DIMENSIONS

A	Outside Diam. mm	260
B	Inside Diam. mm	105.5
C	Thickness mm	5
D	Fixing Holes Number	5
E	Fixing Holes Diam. mm	10.6
F	Fixing Holes Centreline Diam. mm	130

FMD0441R

Available

FRONT / REAR

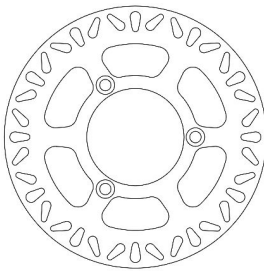
**FMD0444R**

Available

REAR

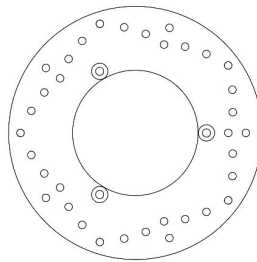
**FMD0445R**

Available

REAR

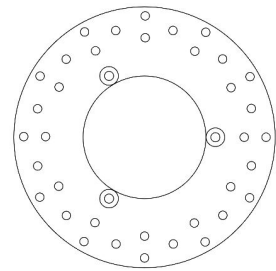
**DIMENSIONS**

A	Outside Diam. mm	240
B	Inside Diam. mm	89
C	Thickness mm	4.5
D	Fixing Holes Number	3
E	Fixing Holes Diam. mm	10.5
F	Fixing Holes Centreline Diam. mm	110

DIMENSIONS

A	Outside Diam. mm	267
B	Inside Diam. mm	132.2
C	Thickness mm	5
D	Fixing Holes Number	3
E	Fixing Holes Diam. mm	8.5
F	Fixing Holes Centreline Diam. mm	150

DIMENSIONS

A	Outside Diam. mm	245
B	Inside Diam. mm	115
C	Thickness mm	5
D	Fixing Holes Number	3
E	Fixing Holes Diam. mm	8.5
F	Fixing Holes Centreline Diam. mm	133

For A,B,C,D,E,F see first page of this section

12042**FERODO**

RACING

Updated on November 2020

FMD0446R

Available

FRONT / REAR

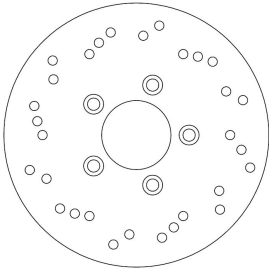
**FMD0447R**

Available

FRONT

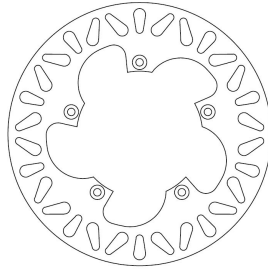
**FMD0448R**

Available

REAR

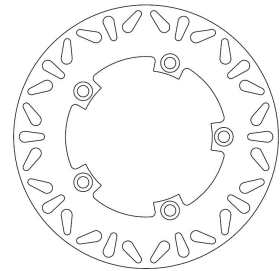
**DIMENSIONS**

A	Outside Diam. mm	226
B	Inside Diam. mm	59.1
C	Thickness mm	4
D	Fixing Holes Number	5
E	Fixing Holes Diam. mm	10.5
F	Fixing Holes Centreline Diam. mm	90

DIMENSIONS

A	Outside Diam. mm	220
B	Inside Diam. mm	105.2
C	Thickness mm	4.5
D	Fixing Holes Number	5
E	Fixing Holes Diam. mm	6.3
F	Fixing Holes Centreline Diam. mm	120

DIMENSIONS

A	Outside Diam. mm	240
B	Inside Diam. mm	120.1
C	Thickness mm	5
D	Fixing Holes Number	5
E	Fixing Holes Diam. mm	10.4
F	Fixing Holes Centreline Diam. mm	141

FMD0449R

Available

REAR

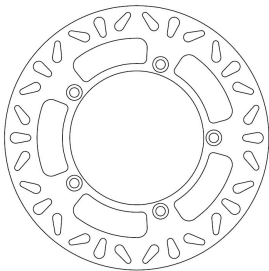
**FMD0450R**

Available

FRONT

Includes spacer+washer kit

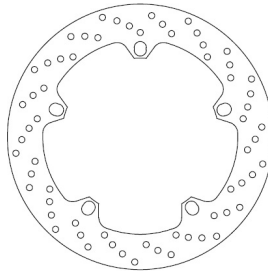
**FMD0451R**

Available

REAR

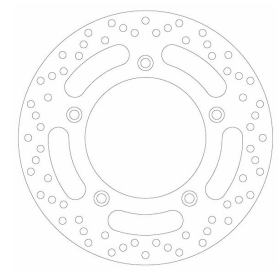
**DIMENSIONS**

A	Outside Diam. mm	285
B	Inside Diam. mm	144.4
C	Thickness mm	6
D	Fixing Holes Number	5
E	Fixing Holes Diam. mm	10.3
F	Fixing Holes Centreline Diam. mm	166.3

DIMENSIONS

A	Outside Diam. mm	305
B	Inside Diam. mm	181
C	Thickness mm	4.6
D	Fixing Holes Number	5
E	Fixing Holes Diam. mm	13.8x16.5
F	Fixing Holes Centreline Diam. mm	203.15

DIMENSIONS

A	Outside Diam. mm	282.0
B	Inside Diam. mm	132.0
C	Thickness mm	5.0
D	Fixing Holes Number	5.0
E	Fixing Holes Diam. mm	10.75
F	Fixing Holes Centreline Diam. mm	165.0

For A,B,C,D,E,F see first page of this section

FMD0452R

Available

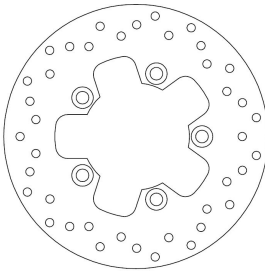
FRONT**FMD0453R**

Available

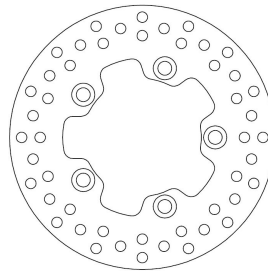
REAR**FMD0454R**

Available

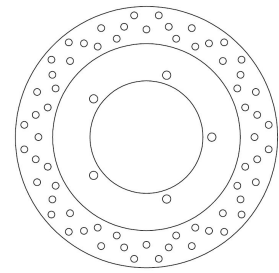
FRONT**DIMENSIONS**

A	Outside Diam. mm	220
B	Inside Diam. mm	89.5
C	Thickness mm	4
D	Fixing Holes Number	5
E	Fixing Holes Diam. mm	10.5
F	Fixing Holes Centreline Diam. mm	110

DIMENSIONS

A	Outside Diam. mm	200
B	Inside Diam. mm	89.5
C	Thickness mm	4
D	Fixing Holes Number	5
E	Fixing Holes Diam. mm	10.5
F	Fixing Holes Centreline Diam. mm	110

DIMENSIONS

A	Outside Diam. mm	267
B	Inside Diam. mm	115
C	Thickness mm	4
D	Fixing Holes Number	5
E	Fixing Holes Diam. mm	8.5
F	Fixing Holes Centreline Diam. mm	133

FMD0456MXR

Available

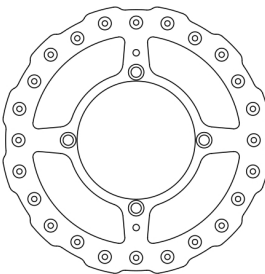
FRONT**FMD0457MXR**

Available

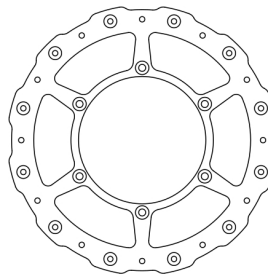
FRONT**FMD0459R**

Available

REAR

RS version available Q3

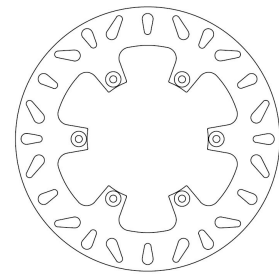
**DIMENSIONS**

A	Outside Diam. mm	250
B	Inside Diam. mm	109.5
C	Thickness mm	3
D	Fixing Holes Number	4
E	Fixing Holes Diam. mm	9.5
F	Fixing Holes Centreline Diam. mm	126

DIMENSIONS

A	Outside Diam. mm	250
B	Inside Diam. mm	118
C	Thickness mm	3
D	Fixing Holes Number	6
E	Fixing Holes Diam. mm	6.5
F	Fixing Holes Centreline Diam. mm	134

DIMENSIONS

A	Outside Diam. mm	240
B	Inside Diam. mm	110
C	Thickness mm	4 (5 RS)
D	Fixing Holes Number	6
E	Fixing Holes Diam. mm	6.5
F	Fixing Holes Centreline Diam. mm	125

For A,B,C,D,E,F see first page of this section

12044**FERODO**

RACING

Updated on November 2020

FMD0459RS

In Introduction

REAR

RS version available Q3

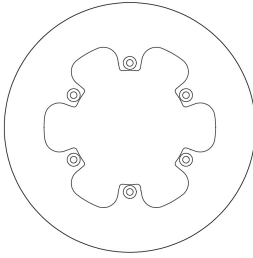
**FMD0460MXR**

Available

FRONT

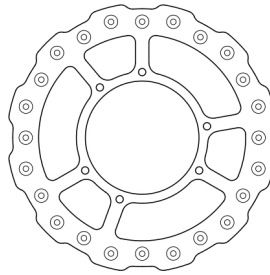
**FMD0461MXR**

Available

FRONT

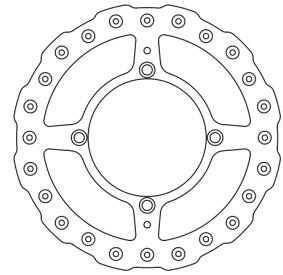
**DIMENSIONS**

A	Outside Diam. mm	240
B	Inside Diam. mm	110
C	Thickness mm	4 (5 RS)
D	Fixing Holes Number	6
E	Fixing Holes Diam. mm	6.5
F	Fixing Holes Centreline Diam. mm	125

DIMENSIONS

A	Outside Diam. mm	260
B	Inside Diam. mm	101
C	Thickness mm	3
D	Fixing Holes Number	6
E	Fixing Holes Diam. mm	6.5
F	Fixing Holes Centreline Diam. mm	117

DIMENSIONS

A	Outside Diam. mm	270
B	Inside Diam. mm	109.5
C	Thickness mm	3
D	Fixing Holes Number	4
E	Fixing Holes Diam. mm	9.5
F	Fixing Holes Centreline Diam. mm	126

FMD0462MXR

Available

FRONT

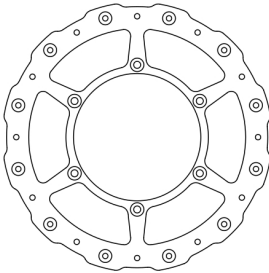
**FMD0463R**

Available

FRONT

Stock available : May 2019

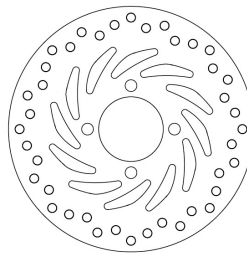
**FMD0464R**

Available

REAR

Stock available : May 2019

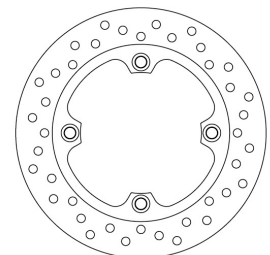
**DIMENSIONS**

A	Outside Diam. mm	270
B	Inside Diam. mm	118
C	Thickness mm	3
D	Fixing Holes Number	6
E	Fixing Holes Diam. mm	6.5
F	Fixing Holes Centreline Diam. mm	134

DIMENSIONS

A	Outside Diam. mm	220
B	Inside Diam. mm	58
C	Thickness mm	4
D	Fixing Holes Number	4
E	Fixing Holes Diam. mm	10.5
F	Fixing Holes Centreline Diam. mm	78

DIMENSIONS

A	Outside Diam. mm	240
B	Inside Diam. mm	116.5
C	Thickness mm	5
D	Fixing Holes Number	4
E	Fixing Holes Diam. mm	10.5
F	Fixing Holes Centreline Diam. mm	135

For A,B,C,D,E,F see first page of this section

FMD0465R

Available

REAR

Stock available : May 2019

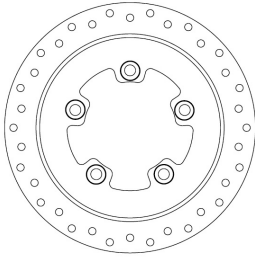
**DIMENSIONS**

A	Outside Diam. mm	240
B	Inside Diam. mm	87.5
C	Thickness mm	4
D	Fixing Holes Number	5
E	Fixing Holes Diam. mm	10.5
F	Fixing Holes Centreline Diam. mm	110

FMD0466R

In Introduction

REAR

Forecast Availability Q3

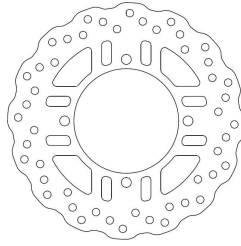
**DIMENSIONS**

A	Outside Diam. mm	250
B	Inside Diam. mm	110.5
C	Thickness mm	6
D	Fixing Holes Number	4
E	Fixing Holes Diam. mm	10.5
F	Fixing Holes Centreline Diam. mm	130

FMD0467R

In Introduction

REAR

Forecast Availability Q3

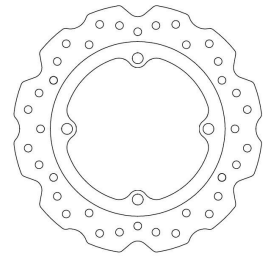
**DIMENSIONS**

A	Outside Diam. mm	240
B	Inside Diam. mm	118
C	Thickness mm	5
D	Fixing Holes Number	4
E	Fixing Holes Diam. mm	10.5
F	Fixing Holes Centreline Diam. mm	118

FMD0468R

In Introduction

REAR

Forecast Availability Q3

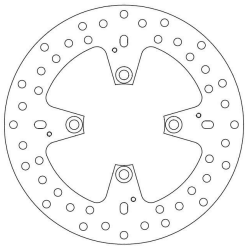
**DIMENSIONS**

A	Outside Diam. mm	245
B	Inside Diam. mm	83.5
C	Thickness mm	5
D	Fixing Holes Number	4
E	Fixing Holes Diam. mm	9.9
F	Fixing Holes Centreline Diam. mm	102

FMD0469R

In Introduction

REAR

Forecast Availability June 2019

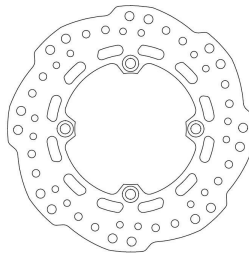
**DIMENSIONS**

A	Outside Diam. mm	256
B	Inside Diam. mm	116
C	Thickness mm	6
D	Fixing Holes Number	4
E	Fixing Holes Diam. mm	10.5
F	Fixing Holes Centreline Diam. mm	136

FMD0470R

In Introduction

REAR

Forecast Availability June 2019

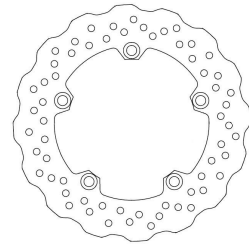
**DIMENSIONS**

A	Outside Diam. mm	245
B	Inside Diam. mm	132
C	Thickness mm	5
D	Fixing Holes Number	5
E	Fixing Holes Diam. mm	10.5
F	Fixing Holes Centreline Diam. mm	150

For A,B,C,D,E,F see first page of this section

12046**FERODO**

RACING

Updated on November 2020

FMD0471R

In Introduction

REAR

Forecast Availability June 2019

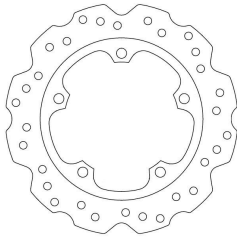
**FMD0472R**

In Introduction

REAR

Forecast Availability Q3

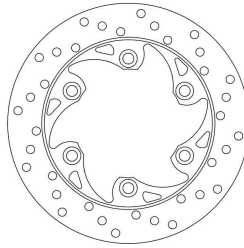
**FMD0473R**

In Introduction

REAR

Forecast Availability June 2019

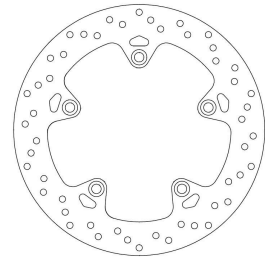
**DIMENSIONS**

A	Outside Diam. mm	240
B	Inside Diam. mm	118
C	Thickness mm	5
D	Fixing Holes Number	5
E	Fixing Holes Diam. mm	10.5
F	Fixing Holes Centreline Diam. mm	136

DIMENSIONS

A	Outside Diam. mm	230
B	Inside Diam. mm	105
C	Thickness mm	4
D	Fixing Holes Number	6
E	Fixing Holes Diam. mm	10.5
F	Fixing Holes Centreline Diam. mm	124

DIMENSIONS

A	Outside Diam. mm	276
B	Inside Diam. mm	136.5
C	Thickness mm	5
D	Fixing Holes Number	5
E	Fixing Holes Diam. mm	10.5
F	Fixing Holes Centreline Diam. mm	160

FMD0474R

Available

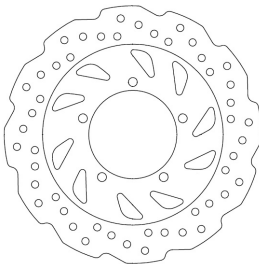
FRONT**DIMENSIONS**

A	Outside Diam. mm	245
B	Inside Diam. mm	82
C	Thickness mm	4
D	Fixing Holes Number	5
E	Fixing Holes Diam. mm	8.4
F	Fixing Holes Centreline Diam. mm	100

For A,B,C,D,E,F see first page of this section



A black and white photograph of a hand in a black leather motorcycle glove pointing towards the right. The hand is resting on a document with a grid pattern. The background is dark and out of focus.

FERODO[®]

DISC BUYER'S GUIDE

FERODO[®]

MOTORCYCLE



CC FROM TO FRONT / REAR

Model	CC	FROM	TO	FRONT / REAR
FMD0001 APRILIA S AMICO all models	50	1992		F
S SONIC GP	50	1997		F
S SONIC SPICE	50	1997		F
BS VILLA S AX	50	1993		F
S GZ	50	1993		F
FANTIC MOTOR M BIG WHEELS	50	1991	1994	F
S GRINTA	50	1995	2000	F
GARELLI S BIG WHEEL	50	1993		F
S BIP-RACING	50	1994		F
S GRINTA	50	1995		F
S PONY SR	50	1992		F
S QUEENIE	50	1995		F
GILERA S EASY MOVING	50	1995		F
ITALJET S BAZOOKA 2	50	1992		F
S PISTA	50	1992		F
S SCOOP	50	1993		F
S YANKEE 8	50	1994		F
MBK S CR Z TARGET	50	1991	1995	F
S CW BOOSTER	50	2001		F
S CW BOOSTER SPIRIT	50	1996	1998	F
S CW R BOOSTER ROAD	50	1994	1995	F
S TARGET	50	1992	1994	F
S YA R FORTE	50	1994	1995	F
S YE EVOLIS	50	1992	1994	F
S YM FIZZ	50	1994	1995	F
S EVOLIS	80	1994	1997	F
PGO S BIG MAX	50	1994	2002	F
S MEGA FIFTY	50	1999		F
S PMX	50	1997	1999	F
S BIG MAX	80	1995		F
PIAGGIO S ZIP FAST RIDER	50	1993	1994	F
S ZIP FAST RIDER	50	1995		F
S ZIP RST	50	1996	1999	F
VILLA S AX	50	1993		F
S GZ	50	1993		F
YAMAHA S AXIS YA	50	1993		F
S BREEZE YM	50	1994	1996	F
S BW S	50	1997		F
S BW S R	50	1995	1996	F
S CR Z	50	1992		F
S JOG (ITALIA)	50	1991	1996	F
S YM BREEZE (Rear Drum Model)	50	1994	1998	F
S JOG	90	1990		F
FMD0002 APRILIA S AREA 51	50	1998		F/R
S AREA 51 SBK	50	2000	2002	R
S GULLIVER	50	1995	1998	F
S HABANA	50	1998		F
S MOJTO	50	1999	2004	F
S RALLY	50	1995		F
S RALLY liquid cooled	50	1996		F/R
S SCARABEO	50	1998	2005	F
S SCARABEO 4T	50	2002	2009	R
S SCARABEO DE-LUX	50	1998	2002	R
S SCARABEO DITECH	50	2001	2004	R
S SR all models	50	1993	1995	F
S SR H20 DITECH E (carburatore)	50	2000	2002	F/R
S SR H20 DITECH EURO 2	50	2002	2003	F/R
S SR R	50	2018	2019	F/R
S SR R / SR REPLICA SBK	50	2004	2017	F/R
S SR R FACTORY (motore Piaggio)	50	2004	2015	F/R
S SR RACING	50	1997	2004	F/R
S SR STEALTH	50	1997	1999	F/R
S SR STREET	50	2003	2015	F/R
S SR WWW	50	1997	2001	F
S HABANA	125	1998		F
S LEONARDO	125	1995	2004	R
S MOJTO all models	125	1999	2004	F
S SR	125	1999		F
S LEONARDO	150	1997	1998	R
S LEONARDO	150	1999	2004	R
S MOJTO all models	150	1999	2004	F
S SR	150	1999		F
BETA M ARK AC PADDOCK / HB	50	2014	2014	F
S ARK AC/LC	50	1996	2014	F/R
M ARK LC K	50	1999	2006	F/R
M ARK PADDOCK	50	2008	2011	F/R
M ARK RAZOR / FACTORY	50	2010	2011	F/R
M ARK RAZOR / FACTORY	50	2012	2012	R



CC FROM TO FRONT / REAR

Model	CC	FROM	TO	FRONT / REAR
M ARK RR	50	2006	2011	F/R
M ARK TRIBE	50	2008	2012	R
S CHRONO	50	1992	1994	F
S CHRONO ruota da 13	50	1994		F
S QUADRA	50	1995	1996	F
S TEMPO 13	50	1995	1996	F
S NRG	50	1994		F
S STALKER (post freno a disco)	50	1997	2004	F
S STALKER (post freno a tamburo)	50	1997	2004	F
S STORM	50	1994	1995	F
S TYPHOON	50	1994	1997	F
S TYPHOON X	50	1998	1999	F
S TYPHOON XR	50	2000	2000	F
S TYPHOON	80	1993		F
S TYPHOON	125	1995	1998	F
HONDA S BALI	50	1993	1997	F
S YUPI	90	1992		F
HUSQVARNA S WRS	50	1998		F
KEEWAY S FACT EVO 2T/4T	50	2015		F
S ZAHARA 4T	50	2015		F
S ZAHARA	125	2015		F
KREIDLER S FLORETT 2.1 RS / CITY	50	2014	2015	F
KSR MOTO BY GENERIC S IDEO / XOR	50	2005		F
S ROC	50	2008		F
M XOR 2	50	2010		F
S IDEO / XOR	125	2005		F
KTM S KROSS	50	1996		F
MACAL S BIG WARRIOR / THUNDER	50	1995	1996	F
S FLASH	50	1995	1997	F
MALAGUTI S CR1 CROSSER	50	1995	1998	F
S F12 PHANTOM	50	1994	1998	F
S F12 PHANTOM LC	50	1994	1998	F
S F12 PHANTOM LC	50	1999	2000	R
S F15 FIREFOX	50	1996	1997	R
S PHANTOM MAX	100	1999		R
MBK S CW BOOSTER NG	50	1999		F
S OVETTO	50	1997	2010	F
S OVETTO	100	1999	2002	F
M XR7	50	1999		F
MOTRON S GL 4 FLASH ID	50	1989	1993	F
S RZ 1 ES	50	1989	1994	F
S SPIKE S	50	1998		F
S SYNCRO	50	1999		F
S ZR THUNDER	50	1995		F
PEUGEOT S BUXY	50	1994		F
S BUXY RS	50	1994		F
S ELYSEO	50	1998	2001	F
S Jet C-Tech	50	2012	2013	R
S SPEEDAKE	50	1995		F
S SPEEDFIGHT (Pinza Brembo)	50	1996		F
S SPEEDFIGHT M (Pinza Heng-Tong)	50	1997		F
S SQUAB	50	1996		F
S SV GEO	50	1992		F
S SV GEO (all models)	50	1993		F
S SV ROLLAND GARROS	50	1993		F
S SV SPORT	50	1993		F
S SV T (forcella telescopica)	50	1993		F
S TREKKER	50	1997		F
S TREKKER (forcelle Paioli)	50	1997		F
S VIVACITY (forcelle Paioli)	50	1998	2007	F
S SV EXECUTIVE	80	1996		F
S TREKKER	100	1998		F
S VIVACITY	100	1999	2001	F
S SV GEO	125	1991	1992	F
S SV GEO	125	1993		F
PIAGGIO S NRG	50	1994	1996	F
S NRG	50	1997		F
S NRG EXTREME	50	1999	2000	F
S NRG MC2	50	1996		F
S NRG MC3	50	2001	2004	F
S NTT	50	2001	1995	F
S TYPHOON 2T (GRIMECA CAL/10 WHEELS)	50	2000	2004	F
S TYPHOON 2T (HENG TONG CAL/10 WHEELS)	50	2001	2009	F
RIEJU M FIRST H2O	50	1997		F
M MRT SUPERMOTO	50	2012	2013	F
SYM S ALLO	50	2012	2013	F
S Orbit II 50 (4T)	50	2014	2018	F
S SYMPLY II 50	50	2014	2015	F

13000

FERODO
RACING
Updated on November 2020

M = MOTORCYCLE
S = SCOOTER
A = ATV
Sn = SNOWMOBILE



CC FROM TO FRONT / REAR

Code	Brand	Model	CC	FROM	TO	FRONT / REAR		
...FMD0002	YAMAHA	S ALLO 4T	125	2012	2017	F		
		S FIDDLE III 125 4T CBS 12" wheels	125	2014	2018	F		
		S ALLO / FIDDLE II	150	2012	2013	F		
		S NEO'S	50	1997	2006	F		
		S NEO'S	100	2000	2002	F		
FMD0003	APRILIA	S SCARABEO 2T	50	2010	2019	F		
		S SCARABEO 4T 4V	50	2010	2017	F		
		S SCARABEO	100	1999	2006	F		
		S SCARABEO 4T	100	2010	2016	F		
		S LEONARDO	125	1995	2004	F		
		S SCARABEO (motore Rotax)	125	1999	2003	R		
		S SCARABEO GT	125	1999	2003	R		
		S SCARABEO i.e.	125	2010	2015	F		
		S SPORT CITY	125	2004	2005	R		
		S SPORT CITY CUBE	125	2008	2010	R		
		S SPORT CITY EU3	125	2006	2008	R		
		S LEONARDO	150	1997	1998	F		
		S LEONARDO	150	1999	2004	F		
		S SCARABEO	150	1998	2003	R		
		S SCARABEO GT	150	2004		R		
		S SCARABEO	200	2001	2003	R		
		S SCARABEO GT	200	2002	2004	R		
		S SPORT CITY	200	2004	2005	R		
		S SPORT CITY CUBE	200	2009		R		
		S SPORT CITY EU3	200	2006	2008	R		
		S LEONARDO	250	1999	2001	F		
		S LEONARDO ST	250	2001	2004	F		
		S SPORT CITY CUBE	250	2008	2010	R		
		S SPORT CITY EU3	250	2006		R		
		S LEONARDO	300	2002	2004	F		
		S SCARABEO S i.e.	300	2009	2012	F		
		S SCARABEO i.e.	500	2010	2012	F		
		BETA	S EIKON	125	1999		F	
		DERBI	S RAMBLA i	300	2010	2012	R	
		FMD0005	APRILIA	M RS	250	1995	2003	R
				M RSV	1000	1998	2000	R
				M RSV	1000	2001	2002	R
				M RSV R	1000	2000	2001	R
				M RSV R	1000	2001	2005	R
				M RSV R FACTORY	1000	2004	2008	R
	M RSV R TUONO			1000	2003	2005	R	
	M RSV R TUONO FACTORY			1000	2006	2009	R	
	M RSV SP			1000	1999	2000	R	
	M RSV TUONO			1000	2002	2005	R	
	M RSV TUONO FIGTHER			1000	2003	2005	R	
M RSV4 FACTORY	1000			2009	2010	R		
M RSV4 FACTORY ABS	1000			2013		R		
M RSV4 FACTORY APRC	1000			2011	2012	R		
M RSV4 FACTORY APRC R - ABS	1000			2011	2013	R		
M RSV4 R	1000			2010	2010	R		
M RSV4 R	1000			2011	2011	R		
M RSV4 R APRC ABS	1000			2013	2014	R		
M RSV4 SBK RACING	1000			2009	2010	R		
M SL 1000 FALCO	1000			2000	2004	R		
M TUONO V4 R	1000			2011	2013	R		
M TUONO V4 R APRC	1000			2011	2013	R		
M TUONO V4 R APRC ABS	1000			2014		R		
M CAPO NORD RALLY	1200			2013	2015	R		
M CAPONORD	1200			2013	2014	R		
BENELLI	M TORNADO TRE			900	2003	2006	R	
	M TORNADO TRE RS			900	2004	2006	R	
LAVERDA	M SFC			1000	2003		R	
MONDIAL	M PIEGA (1000cc)			999	2003		R	
	M PIEGA EVO (1000cc)			999	2003		R	
	M PIEGA NUDA (1000cc)			999	2004		R	
	M RZ NUDA (1000cc)			999	2002		R	
	M RZ STARFIGHTER (1000cc)			999	2002		R	
FMD0006	CAGIVA			S CITY	50	1992	1994	F
				S CITY	80	1993		F
			S PASSING	125	1994		F	
			S DIO GP	50	1991		F	
			S DIO SR	50	1990		F	
	HONDA		S DIO ZX	50	1992		F	
			S HSC all models	50	1992		F	
		S LIFE DIO ZX	50	1994		F		
		S SFX	50	1995		F		
		S NH LEAD	125	1988		F		
	KYMCO	S CX	50	1994		F		



CC FROM TO FRONT / REAR

Code	Brand	Model	CC	FROM	TO	FRONT / REAR			
	SYM	S CX CURIO SUPER	50	1994		F			
		S FILLY LX	50	2001	2002	F			
		S HEROISM	50	1995	1996	F			
		S K 12	50	1995		F			
		S KB	50	1994		F			
		S SNIPER	50	1993		F			
		S SNIPER DD	50	1994	1996	F			
		S HEROISM	125	1995	1997	F			
		S HEROISM	150	1995	1997	F			
		S CINDERELLA	50	1999	2002	F			
		S MIO	50	2006	2007	F			
		S SUPER FANCY	50	1999	2000	F			
		S CINDERELLA	100	1999		F			
		S ATTILA	125	1995	1998	F			
		S MEGALO	125	2006	2007	F			
		S NEW DUKE	125	2000	2001	F			
		S SR	125	1998		F			
		S SUPER DUKE	125	1999	2002	F			
		S ATTILA	150	2000	2001	F			
		FMD0007	APRILIA	S SR MOTARD 2T	50	2012	2018	F	
				S SR MOTARD	125	2012	2016	F	
				BENELLI	S ADIVA	125	2000	2002	F
					S ADIVA	150	2000	2002	F
				DERBI	S VARIANT SPORT 2T	50	2014	2018	F
			GILERA	S VARIANT SPORT 4T	125	2014	2017	F	
S RUNNER	50			1996		F			
S RUNNER DD - SP	50			1997	2004	F			
S RUNNER PURE JET	50			2002	2006	F			
S RUNNER SP	50			1998	2006	F			
S RUNNER SP RACE	50			2006		F			
S RUNNER SP SC	50			2006	2007	F			
S RUNNER	125			1997	1999	F			
S RUNNER FX - FXR	125			1997	2002	F			
S RUNNER SP	125			1999		F			
PGO	S RUNNER VX / VXR 4T		125	2001	2004	F			
	M RUNNER		180	1997	1998	F			
	S RUNNER FXR		180	1998		F			
	S RUNNER SP		180	1999		F			
	S RUNNER VXR		180	2001	2004	F			
	S RUNNER VX / VXR 4T		200	2002		F			
	S RUNNER VXR 4T		200	2005	2006	F			
	S RUNNER VXR 4T RACE		200	2006		F			
	S RUNNER VXR 4T ST EURO 3		200	2008		F			
	S RUNNER VXR EURO 3		200	2007		F			
	PIAGGIO		S CLASSIC SPORT	50	1997		F		
			S ENERGY EXTREME	50	1999		F		
			S TYPHOON 12"	50	2010	2017	F		
			S SKIPPER 4T	125	1998		F		
			S SKIPPER LX	125	1998	2002	F		
S SKIPPER ST 4T (grimeca caliper)			125	2000	2004	F			
S SKIPPER ST 4T (heng tong caliper)			125	2000	2004	F			
S SKIPPER 4T			150	2000	2002	F			
S SKIPPER LX			150	1998	2006	F			
S SKIPPER LXT			150	1998	2006	F			
FMD0009	BUELL	M 1200 all models	1200	1994	1997	R			
		M M2 CYCLONE	1200	1998	2002	R			
		M S1 LIGHTNING	1200	1998	2002	R			
		M S1 WHITELIGHTNING	1200	1998	2002	R			
		M S3 THUNDERBOLT	1200	1998	2002	R			
	CAGIVA	M S3T THUNDERBOLT	1200	1998	2002	R			
		M X1 LIGHTNING	1200	1999	2002	R			
		M ELEFANT	750	1994	1995	R			
		M ELEFANT I.E.	900	1990	1992	R			
		M ELEFANT I.E.	900	1993	1996	R			
		M GRAN CANYON	900	1999	2004	R			
		M NAVIGATOR	1000	2000	2005	R			
		HONDA	S @ NES	125	2009		R		
			S FORZA ABS	125	2015	2019	R		
			S SH i	125	2009	2019	R		
S @ NES	150		2009		R				
S SH i	150		2009	2019	R				
	S SH i SPORTY	150	2009	2011	R				
	M CB TWO FIFTY	250	1993	2005	F				
	S FORZA X NSS	250	2005	2007	R				
	S FORZA X NSS	250	2008		R				
	S FORZA XE NSS	250	2005	2007	R				
	S FORZA XE NSS	250	2008		R				
	S FORZA ABS	300	2014	2018	R				

M = MOTORCYCLE
S = SCOOTER
A = ATV
Sn = SNOWMOBILE



CC FROM TO FRONT / REAR

Code	Brand	Model	CC	FROM	TO	FRONT / REAR		
...FMD0009		S FORZA DELUXE ABS	300	2019		R		
		M SH 300 i ABS (NF05)	300	2015	2019	R		
		M CB 400 Super Four (NC31)	400	1992	1997	R		
		M CB 400 Super Four (NC36)	400	1997	1998	R		
		M CB	500	1997	2003	R		
		M CB S	500	1998	2002	R		
		M XL V TRANSALP	600	1991	1996	R		
		M XL V TRANSALP	600	1997	1999	R		
		M XL V TRANSALP	650	2000	2007	R		
		M XRV AFRICA TWIN	650	1988	1990	R		
		M XL V TRANSALP	700	2008	2011	R		
		M XL V TRANSALP ABS	700	2008	2011	R		
		M CB N SEVEN FIFTY	750	1992	2002	R		
		M CB F HORNET	900	2002	2006	R		
		M CB HORNET	900	2002	2007	R		
		FMD0010	HONDA	M CBR R	125	2003	2011	F
				M VFR R	400	1985	1986	F
				M VFR R	400	1988	1988	F
				M VFR Z	400	1986	1987	F
				M CBR F	600	1987	1990	F
M CBR F	600			1991	1994	F		
M SILVER WING	600			2007	2007	F		
S SILVER WING ABS	600			2003	2007	F		
M FX VIGOR	650			1999	2003	F		
M VIGOR	650			1999	2002	F		
M CBX F	750			1983	1988	F		
M VFR F INTERCEPTOR	750			1986	1987	F		
M XLV R	750			1983	1987	F		
M VF F	1000			1984	1988	F		
M VF R	1000			1986	1987	F		
M TIGER	900			1993	1998	F		
FMD0011	HONDA			M XLR R BAJA	250	1988	1990	R
				M XLR R BAJA	250	1991		R
		M FMX	650	2005	2008	R		
		M NX DOMINATOR	650	1993	2004	R		
		M SLR	650	1997	1998	R		
		M VIGOR	650	1999	2002	R		
FMD0014	HONDA	S PANTHEON FES	125	2003	2007	R		
		S S-WING FES	125	2008		R		
		S PANTHEON FES	150	2003	2007	R		
		S S-WING FES	150	2007		R		
		M CBR R	250	2011	2016	R		
		M CBR R ABS	250	2014	2016	R		
		S FORESIGHT	250	1999	2007	R		
		S FORZA NSS	250	2000	2004	R		
		M HORNET	250	1997		R		
		S JAZZ	250	2001	2004	R		
		M VTR	250	1998		R		
		M VTR-F	250	2013		R		
		M XELVIS V-25	250	1997		R		
		M CB N	400	1982	1988	R		
		M CB F HORNET	600	1998	1999	R		
		M CB F HORNET	600	2000	2006	R		
		M CB F HORNET S	600	2000	2004	R		
		M CBR F	600	1991	1994	R		
		M CBR F	600	1995	1998	R		
		M CBR F	600	1999	2000	R		
		M CBR F	600	2001	2007	R		
		M CBR F SPORT	600	2001	2002	R		
		M CBR RR	600	2003	2006	R		
		M CBR RR	600	2007	2017	R		
		M NX DOMINATOR	650	1988	1992	R		
		M XR L	650	1993	2012	R		
		M CBR RR	900	1992	1993	R		
		M CBR RR	900	1994	1997	R		
		M CBR RR	900	1998	1999	R		
		M CBR RR	929	2000	2001	R		
		M CBR RR	954	2002	2003	R		
		M CBR RR Fireblade	1000	2004	2005	R		
		M CBR RR Fireblade	1000	2006	2007	R		
		M CBR RR Fireblade	1000	2008	2015	R		
		M CBR RR Fireblade ABS	1000	2009	2016	R		
		M CBR RR Fireblade ABS	1000	2017	2019	R		
		M CBR RR Fireblade SP	1000	2014	2016	R		
		M CBR RR Fireblade SP	1000	2017	2018	R		
		M VTR F FIRESTORM	1000	1997	2007	R		
		M VTR F SUPER HAWK	1000	1997	2007	R		
		M VTR SP1 RC51	1000	2000	2001	R		



CC FROM TO FRONT / REAR

Code	Brand	Model	CC	FROM	TO	FRONT / REAR
	KSR MOTO BY GENERIC TRIUMPH	M VTR SP2 RC51	1000	2002	2004	R
		M Rumbler	125	2013	2016	R
		M BABY SPEED	600	2001	2002	R
		M DAYTONA	600	2003	2007	R
		M SPEED FOUR	600	2003	2006	R
		M TT	600	2000	2003	R
		M DAYTONA	675	2006	2012	R
		M DAYTONA R	675	2011	2012	R
		M STREET TRIPLE	675	2007	2012	R
		M STREET TRIPLE R	675	2009	2012	R
		M SPEED TRIPLE T509	900	1997	1998	R
		M DAYTONA T595	950	1996	1998	R
		M DAYTONA T955i	955	1999	2001	R
		M DAYTONA T955i	955	2002	2006	R
		M SPEED TRIPLE T955	955	1999	2001	R
		M SPEED TRIPLE T955	955	2002	2005	R
		M T955 DAYTONA	955	1999	2001	R
M T955 DAYTONA	955	2002		R		
M SPEED TRIPLE	1050	2005	2010	R		
M SPEED TRIPLE ST	1050	2005	2006	R		
FMD0015	HONDA	M CRF F	150	2003	2008	F
		M CRF F	230	2004	2008	F
		M CRF TRAIL	230	2004	2010	F
		M SL	230	1997	2001	F
		M XLR R BAJA	250	1988	1990	F
		M XLR R BAJA	250	1991		F
		M XR	250	2000	2003	F
		M XR BAJA	250	2000	2003	F
		M XR R	250	1988	1990	F
		M XR R	250	1991	2004	F
		M XR R, S	250	1994		F
		M XR R	400	1995	2005	F
FMD0017	BETA	M XR R (DALLARA)	440	1999		F
		M XL R	600	1983	1987	F
		M XR L - R	600	1993	2000	F
		M XR R	600	1985	1990	F
		M XR R	600	1991	1999	F
		M XR R	650	2000	2007	F
		M XR R	650	2008		F
		M RR 250	250	2013		F
		M RR 2T ENDURO 250	250	2014		F
		M RR	300	2013		F
HUSABERG		M RR 2T ENDURO 300	300	2013		F
		M RR 4T ENDURO 350	350	2013		F
		M RR EFI	350	2015		F
		M RR EFI RACING	350	2015		F
		M RR	390	2015		F
		M RR 4T ENDURO 390	390	2015		F
		M RR 4T ENDURO 400	400	2013	2014	F
		M RR 4T ENDURO 430	430	2015		F
		M RR RACING	430	2015		F
		M RR 4T ENDURO 450	450	2013	2015	F
		M RR CROSS 450	450	2013	2014	F
		M RR 4T ENDURO 480	480	2015		F
		M RR RACING	480	2015		F
		M RR 4T ENDURO 498	498	2012	2014	F
		M RR 4T FACTORY 498	498	2012		F
		M FE	390	2011	2012	F
		M FE	390	2013		F
		M FC	400	1999	2002	F
		M FE	400	2000	2003	F
		M FE E	400	2001	2003	F
		M FE S - E	400	1998	1999	F
		M FS C	400	2001	2003	F
		M FS E	400	2001	2003	F
		M FC	450	1998	2003	F
		M FE	450	2009	2012	F
		M FE E	450	2004		F
		M FX	450	2003	2009	F
		M FX	450	2010		F
M FC E	470	2001	2002	F		
M FX E	470	2001	2002	F		
M FC	501	1998	1998	F		
M FC	501	1999	2003	F		
M FE E	501	1999	2004	F		
M FE S	501	1999	2004	F		
M FE S - E	501	1998	2004	F		
M FC	550	2001	2005	F		



CC FROM TO FRONT / REAR

...FMD0017

HUSQVARNA

KTM

		CC	FROM	TO	FRONT / REAR
M	FC	550	2006		F
M	FE E	550	2004	2008	F
M	FE	570	2009	2010	F
M	FE	570	2010	2012	F
M	FC	600	1999	2003	F
M	FE E	600	1999	2002	F
M	FE S	600	1999	2003	F
M	FE E	650	2001	2008	F
M	FS E- C	650	2001	2004	F
M	FX E	650	2001	2005	F
M	FX E	650	2006		F
M	TC	125	2014		F
M	TE	125	2014	2015	F
M	TE 4T	125	2011	2013	F
M	FC	250	2014	2016	F
M	FE	250	2014	2015	F
M	TC	250	2014		F
M	TE	250	2014	2016	F
M	TE	300	2014	2015	F
M	FC	350	2014	2016	F
M	FE	350	2014	2015	F
M	FC	450	2014	2016	F
M	FE	450	2014	2015	F
M	TE	450	2014		F
M	FE	501	2014	2015	F
M	EXC	125	1990	1993	F
M	EXC	125	1998	2014	F
M	EXC	125	2015		F
M	EXC SIX DAYS	125	2004	2008	F
M	EXC SIX DAYS	125	2009	2014	F
M	EXC SIX DAYS	125	2015		F
M	EXC/EGS	125	1994	1997	F
M	EXE	125	2000	2011	F
M	GS	125	1993	1997	F
M	MX	125	1992	2000	F
M	SX	125	1993	2014	F
M	SX	125	2015		F
M	SXS	125	2000	2010	F
M	SX	144	2007	2010	F
M	SX	150	2008	2014	F
M	SX	150	2015		F
M	XC	150	2010	2016	F
M	EGS	200	1998	1999	F
M	EXC	200	1998	2014	F
M	EXC	200	2015		F
M	SX	200	2003	2007	F
M	XC W	200	2008	2016	F
M	EGS	250	1994	1999	F
M	EXC	250	1994	1997	F
M	EXC	250	1998	2014	F
M	EXC	250	2015		F
M	EXC F	250	2007	2014	F
M	EXC F	250	2015		F
M	EXC F SIX DAYS	250	2007	2008	F
M	EXC F SIX DAYS	250	2009	2014	F
M	EXC RACING (4T)	250	2000	2006	F
M	EXC SIX DAYS	250	2004	2008	F
M	EXC SIX DAYS	250	2009	2014	F
M	GS	250	1993	1997	F
M	GS	250	1998	2000	F
M	MX	250	1992	2013	F
M	SX	250	1993	2014	F
M	SX	250	2015		F
M	SX F	250	2001	2004	F
M	SX F	250	2005	2014	F
M	SX F	250	2015		F
M	SXS	250	2001	2002	F
M	SXS	250	2003	2003	F
M	XC	250	2008	2016	F
M	XC (2T)	250	1994	2015	F
M	XC W	250	2006	2010	F
M	XC W	250	2011	2012	F
M	XC W	250	2013		F
M	XCF W	250	2012	2013	F
M	XCF W	250	2014		F
M	EXC	300	1994	1996	F
M	EXC	300	1997	2013	F
M	EXC	300	1997	2002	F



CC FROM TO FRONT / REAR

		CC	FROM	TO	FRONT / REAR
M	EXC EGS	300	1993	1999	F
M	EXC SIX DAYS (2T)	300	2006	2008	F
M	EXC SIX DAYS (2T)	300	2009	2013	F
M	GS	300	1991	1996	F
M	GS	300	1997	2000	F
M	SX	300	1993	2000	F
M	XC (2T)	300	2011	2012	F
M	EXC F	350	2012	2014	F
M	EXC F	350	2015		F
M	EXC F SIX DAYS	350	2012	2013	F
M	GS	350	1993	2000	F
M	SX-F	350	2011	2017	F
M	XC-F	350	2011	2012	F
M	XCF-W	350	2011	2013	F
M	EXC	360	1996	1997	F
M	SX	360	1996	1997	F
M	EXC	380	1998	2002	F
M	MXC	380	1998	2001	F
M	MXC	380	2002	2002	F
M	SX	380	1998	2002	F
M	EGS	400	1996	1999	F
M	EXC	400	1994	2005	F
M	EXC RACING	400	2000	2007	F
M	EXC-G RACING	400	2004	2007	F
M	EXC-G RACING	400	2008		F
M	MXC	400	2000	2001	F
M	MXC	400	2002		F
M	SX	400	2000	2002	F
M	SX	400	2003		F
M	SX RACING	400	2002		F
M	SXC	400	1999	2000	F
M	EXC	450	2003	2007	F
M	EXC R	450	2008	2009	F
M	EXC R	450	2010	2010	F
M	EXC R	450	2011		F
M	EXC RACING	450	2003	2007	F
M	EXC-R RACING (USA)	450	2011		F
M	MXC	450	2003	2006	F
M	MXC	450	2007		F
M	SX	450	2003	2005	F
M	SX	450	2006		F
M	SX-F	450	2003	2014	F
M	SX-F FACTORY REPLICA	450	2012		F
M	XC	450	2006	2006	F
M	XC	450	2007	2007	F
M	XC W	450	2008	2009	F
M	XC W	450	2010		F
M	XC-W SIX DAYS (USA)	450	2011		F
M	EXC	500	2012	2013	F
M	EXC/MX	500	1992	1995	F
M	LC4 EXC/EGS	500	1992		F
M	XC-W	500	2012	2013	F
M	SX F	505	2007	2009	F
M	XC F	505	2007	2009	F
M	EXC	520	2000	2002	F
M	EXC RACING	520	2000	2001	F
M	EXC RACING	520	2002		F
M	MXC	520	2001	2002	F
M	MXC	520	2003		F
M	SX	520	2000	2002	F
M	SX	520	2003		F
M	EXC	525	2003	2007	F
M	EXC RACING	525	2003	2007	F
M	MXC	525	2003	2005	F
M	SX	525	2003	2006	F
M	SX	525	2007	2007	F
M	XC	525	2006	2007	F
M	XC DESERT RACING	525	2006	2007	F
M	EXC R	530	2008	2009	F
M	EXC R	530	2010		F
M	EXC-R RACING (USA)	530	2011		F
M	XC-W	530	2008	2010	F
M	XC-W	530	2011		F
M	XC-W SIX DAYS	530	2011		F
M	XC-W SIX DAYS (USA)	530	2011		F
M	SXC	540	1998	1998	F
M	SXC	540	1999	2000	F
M	GS	600	1993	2000	F

M = MOTORCYCLE
S = SCOOTER
A = ATV
Sn = SNOWMOBILE



CC FROM TO FRONT / REAR

Code	Brand	Model	CC	FROM	TO	FRONT / REAR		
...FMD0017		M LC4	600	1990	1990	F		
		M LC4	600	1991	1992	F		
		M LC4	600	1993	1993	F		
		M LC4 RXC	620	1996	1997	F		
		M LC4 SC	620	1998	2004	F		
		M LC4 SC SUPERCOMP	620	1998	2001	F		
		M LC4 SUPERMOTO	620	1999	2001	F		
		M LC4 SX	620	1995	1999	F		
		M LC4 SC SUPERCOMP	625	2002		F		
		M LC4 SXC	625	2003	2007	F		
		M SXC	625	2003	2007	F		
		M LC4 SUPERMOTO	640	1998	1999	F		
		FMD0018	HUSQVARNA	M CR	125	1996	2003	F
				M CR	125	2004	2013	F
M WR	125			1998	2003	F		
M WR	125			2004	2013	F		
M WRE	125			1995	2004	F		
M WRE	125			2005	2013	F		
M WRE DUAL	125			1995	2003	F		
M CR	250			1996	2003	F		
M CR	250			2004	2013	F		
M TC	250			2002	2013	F		
M TE	250			2002	2003	F		
M TE	250			2004	2013	F		
M TXC	250			2011	2014	F		
M WR	250			1998	2003	F		
M WR	250			2004	2006	F		
M WR	250			2007	2013	F		
M TXC	310			2011	2014	F		
M WR	360			2000	2001	F		
M WR	360			2002		F		
M TE	400			2002	2002	F		
M TE	410			2000	2001	F		
M TE	410			2002	2013	F		
M TC	449			2011	2013	F		
M TC	450			2002	2006	F		
M TC	450			2007	2010	F		
M TE	450			2002	2005	F		
M TE	450			2006	2010	F		
M TE	450			2011	2013	F		
M TXC	450			2011	2013	F		
M TC	510			2002	2006	F		
M TC	510			2007	2009	F		
M TE	510			2002	2005	F		
M TE	510			2006	2010	F		
M TXC	510			2009	2010	F		
M TE	511			2011	2013	F		
M TXC	511			2011	2013	F		
M TC	570			2001	2002	F		
M TC	570			2003	2013	F		
M TE	570			2001	2002	F		
M TE	570			2003	2013	F		
M TE E	610			2000	2003	F		
M TE E	610			2004	2013	F		
FMD0019	ITALJET			S DRAGSTER	50	1997		F
		S FORMULA	50	1994	1996	F		
		S FORMULA	50	1997		F		
		S DRAGSTER	125	1997	1998	F		
		S DRAGSTER	125	1999	2001	F		
		S FORMULA	125	1994	1996	F		
		S FORMULA	125	1997		F		
		S DRAGSTER	180	1997	1998	F		
		S DRAGSTER	180	1999	2001	F		
		FMD0020	KAWASAKI	M EN VULCAN	500	1990	1993	F
M Z 1000	1000			1981	1983	R		
FMD0022	BENELLI GILERA LML	S VELVET DUSK	400	2003		R		
		S DNA	50	2000	2007	R		
		S DNA GP EXPERIENCE	50	2003	2004	R		
		S DNA	125	2001		R		
		S RUNNER VX / VXR 4T	125	2001	2004	R		
		S RUNNER VXR	180	2001	2004	R		
		S RUNNER VX / VXR 4T	200	2002		R		
		S RUNNER VXR 4T	200	2005	2006	R		
		S RUNNER VXR 4T RACE	200	2006		R		
		S RUNNER VXR 4T ST EURO 3	200	2008		R		
		S RUNNER VXR EURO 3	200	2007		R		
		S STAR 2T	125	2010	2015	F		
		S STAR 4T LITE / MANUAL	125	2014	2018	F		



CC FROM TO FRONT / REAR

Code	Brand	Model	CC	FROM	TO	FRONT / REAR	
	MALAGUTI	S STAR AUTOMATIC DELUXE 4T	125	2015	2017	F	
		S STAR DELUXE 4T	125	2001	2018	F	
		S STAR 2T / STAR 4T	150	2010	2012	F	
		S STAR 4T / DELUXE 4T	200	2010	2018	F	
		S CENTRO BASE	50	1993	1994	F	
		S CENTRO SL CAT	50	1994	2000	F	
		S F12 PHANTOM twin disk	50	1998		F	
		S FLY 4T	50	2006		F	
		S FREE	50	1995	2002	F	
		PGO	S VESPA ELECTRIC 3,5 kW		2018		F
			S VESPA ELECTRIC X 4V 3,5 Kw		2018		F
			S VESPA 50 Primavera 4T 3V	49	2019		F
			S FLY 2T	50	2004		F
			S FLY 4T	50	2006	2007	F
			S FLY 4T	50	2010	2017	F
			S FREE (ruote in lega)	50	1996		F
			S QUARTZ (Rear Drum Model)	50	1991	1995	F
			S SFERA ET2	50	1997		F
			S SFERA RST	50	1995		F
		PIAGGIO	S VESPA 50 Primavera 2T / 4T 4V	50	2013	2018	F
			S VESPA ET2	50	1997		F
			S VESPA ET2 4T	50	2000	2001	F
			S VESPA ET2 INIEZIONE	50	1999		F
			S VESPA ET4	50	2001	2004	F
			S VESPA LX 2T	50	2005		F
			S VESPA LX 4T	50	2005		F
			S VESPA LX 4T TOURING	50	2012	2013	F
			S VESPA LXV 4T	50	2012	2013	F
			S VESPA S 2T	50	2007	2013	F
			S VESPA S 2T SPORT	50	2011	2013	F
			S VESPA S 4T	50	2007	2013	F
			S VESPA S 4T 4V SPORT	50	2011	2013	F
			S VESPA SPRINT 50 2T	50	2014	2017	F
			S VESPA SPRINT 50 4T 3V	50	2014	2019	F
			S VESPA SPRINT S 50 2T	50	2015	2017	F
S ZIP SP	50		1996		F		
S SKIPPER	80		1994	1995	F		
S FLY	125		2005	2008	F		
S HEXAGON LX	125		1998	2001	F		
S SFERA 4T	125	1995	1997	F			
S SUPER HEXAGON GTX	125		2000	F/R			
S VESPA ET4	125	1996	2002	F			
S VESPA LX	125	2005	2006	F			
S VESPA LX EURO 3	125	2006	2007	F			
S VESPA PRIMAVERA 4T i.e. 3V	125	2015	2018	F			
S VESPA PRIMAVERA 70	125	2015	2016	F			
S VESPA PX	125	1998		F			
S VESPA S 4T IE & COLLEGE	125	2009	2010	F			
S VESPA SPRINT / S 4T i.e. 3V / ABS	125	2015	2018	F			
S VESPA SPRINT SPORT ABS	125	2017	2017	F			
S FLY	150	2005	2007	F			
S FLY EURO 3	150	2008	2010	F			
S HEXAGON LX	150	1998		F			
S Vespa 150 Primavera 4T 3V	150	2013		F			
S Vespa 150 Primavera Touring 3V	150	2015	2015	F			
S VESPA ET4	150	1996	2002	F			
S VESPA LX	150	2005	2006	F			
S VESPA LX EURO 3	150	2006	2007	F			
S VESPA PX	150	1998		F			
S VESPA S 4T IE & COLLEGE	150	2009	2010	F			
S VESPA SPRINT S 4T 3V ABS	150	2015	2016	F			
S HEXAGON LX	180	1998		F			
S SUPER HEXAGON GTX	180		2000	F/R			
S VESPA PE	200	1998		F			
S VESPA PX	200	1998		F			
S HEXAGON LX	250	1998		F			
S SUPER HEXAGON GT-GTX	250	2000		F/R			
FMD0023	DUCATI	M JUNIOR SS	350	1991	1993	R	
		M MONSTER	400	1994	1999	R	
		M MONSTER	400	2001	2006	R	
		M SS SUPERSPORT	400	1992	1997	R	
		M SS SUPERSPORT JUNIOR	400	1992	1997	R	
		M M MONSTER	600	1994	2002	R	
		M MONSTER	600	1994	2002	R	
		M SS SUPERSPORT	600	1994	2000	R	
		M MONSTER	620	2002	2005	R	
		M MONSTER double disk	620	2005	2006	R	
M MONSTER single disk	620	2005	2006	R			

13004

FERODO
RACING
Updated on November 2020

M = MOTORCYCLE
S = SCOOTER
A = ATV
Sn = SNOWMOBILE



FRONT
/ REAR

CC FROM TO

...FMD0023

		CC	FROM	TO	FRONT / REAR
M	MULTISTRADA double disk	620	2005	2006	R
M	MULTISTRADA single disk	620	2005	2006	R
M	SPORT	620	2003	2004	R
M	SS SUPERSPORT	620	2002	2005	R
M	MONSTER	695	2006	2008	R
M	MONSTER	696	2008	2014	R
M	MONSTER ABS	696	2010	2014	R
M	M MONSTER	750	1996	2001	R
M	MONSTER	750	1994	2001	R
M	SPORT	750	2000	2002	R
M	SS SUPERSPORT	750	1991	2002	R
M	MONSTER	800	2003	2004	R
M	SPORT	800	2003	2004	R
M	SS SUPERSPORT	800	2003	2005	R
M	MONSTER 797 ABS	803	2017		R
M	MONSTER	821	2015		R
M	MONSTER ABS	821	2015	2017	R
M	MONSTER DARK ABS	821	2015	2016	R
M	MONSTER STRIPE ABS	821	2015	2017	R
M	851 STRADA - SP	851	1988	1991	R
M	888 DESMOQUATTRO	888	1993	1994	R
M	888 SP	888	1990	1993	R
M	M MONSTER	900	1993	2001	R
M	MONSTER	900	1993	2004	R
M	SL 900 SUPERLIGHT	900	1991	1997	R
M	SPORT	900	2002		R
M	SS SUPERSPORT	900	1991	2002	R
M	PASO 906	904	1989	1990	R
M	PASO 907 I.E.	904	1990	1991	R
M	MONSTER S4	916	2001	2003	R
M	ST4	916	1998	2004	R
M	ST2	944	1997	2003	R
M	ST3	992	2004	2006	R
M	ST4 S	996	2001	2005	R
M	ST4 S ABS	996	2003	2003	R
M	ST4 S ABS	996	2004	2006	R
M	GT	1000	2006	2010	R
M	GT TOURING	1000	2009		R
M	MONSTER	1000	2003	2005	R
M	MONSTER S	1000	2003	2005	R
M	PAUL SMART LE	1000	2006	2007	R
M	SPORT	1000	2006	2008	R
M	SPORT S	1000	2007	2009	R
M	SS SUPERSPORT	1000	2003	2006	R
M	ST3	1000	2004	2006	R
M	ST3 S ABS	1000	2006	2007	R
S	JUPITER	250	2000	2003	F
M	GHOST	650	1996	1999	R
M	SPORT	650	1995	2001	R
M	DIAMANTE	668	1996	1998	R
M	DIAMANTE / MONO LEGEND	750	1998		R
M	S FORMULA	750	1998	2001	R
M	STRIKE	750	1998	2001	R
M	T-8	800	1998		R
M	TSS	800	1999		R
M	YP SKYLINER	250	2000	2003	F
S	MAXI	125	1999		F
S	MAXI	150	1999		F
S	MAXI	400	1999		F
M	BLACK MAGIC	995	2006	2008	R
M	CAFE RACER	995	2000	2006	R
M	ROADSTER	995	2001	2006	R
M	BOXER	1000	2000		R
M	CYCLOPE	1000	2002		R
M	SCRAMBLER	1000	2006		R
M	STREET SCRAMBLER	1000	2000		R
M	VB1 EVO	1000	2003	2004	R
S	TEOS XN	150	2001	2002	F
S	MAJESTY ABS YP	250	2003		F
S	MAJESTY DX YP	250	1998	1999	F
S	MAJESTY YP	250	1996	1998	F
S	MAJESTY YP	250	2000	2003	F
M	SRX	400	1991		R
M	XJR	400	1995	2000	R
M	FZR	600	1989		R
M	FZR R	600	1990	1995	R
M	FZS FAZER	600	1998	2003	R
M	SRX	600	1985	1987	R

ITALJET
LAVERDA

MBK
MOTOR UNION

VOXAN

YAMAHA



FRONT
/ REAR

CC FROM TO

		CC	FROM	TO	FRONT / REAR		
M	SRX	600	1988	1989	R		
M	XJ DIVERSION S-N	600	1991	1997	R		
M	XJ DIVERSION S-N	600	1998		R		
M	XJ N	600	1991	1997	R		
M	XJ N	600	1998	2003	R		
M	XJ S DIVERSION	600	1991	1997	R		
M	XJ S DIVERSION	600	1998	2003	R		
M	YZF R THUNDERCAT	600	1996	2004	R		
M	YZF R	750	1993	1997	R		
M	YZF R7	750	1999	2001	R		
M	YZF SP	750	1993	1997	R		
M	TDM	850	1991	2001	R		
M	TRX	850	1995	2000	R		
M	TDM	900	2002	2014	R		
M	YZF R THUNDERACE	1000	1996	1998	R		
M	YZF R1	1000	1998	2001	R		
FMD0025	PEUGEOT	S	SPEEDFIGHT (raff. acqua pinze AJP)	50	1998	F/R	
		S	SPEEDFIGHT M (Pinza AJP)	50	1997	F	
		S	SPEEDFIGHT	100	1997	F/R	
FMD0026	SUZUKI	S	BURGMAN	250	1998	F	
		S	BURGMAN AN	400	1999	F	
FMD0027	SUZUKI	M	TS R	125	1989	F	
		M	TS R	200	1989	F	
		M	DR DJEBEL	600	1989	F	
		M	DR R	600	1986	1989	F
		M	DR R DAKAR-DJEBEL	600	1987	1988	F
		M	DR S	600	1986	1988	F
FMD0028	SUZUKI	M	RM	125	1988	2000	F
		M	RM	125	2001	2012	F
		M	RM	250	1989	2000	F
		M	RM	250	2001	2012	F
		M	RMX	250	1989	1999	F
		M	RMX S	250	1992	1998	F
		M	DR Z E	400	2000	2017	F
		M	DR Z S	400	2000	2017	F
	YAMAHA	M	WR	125	2001	2002	F
		M	WR	125	2002	2005	F
		M	YZ	125	1998	2001	F
		M	YZ	125	2002	2007	F
		M	WR	250	2001	2008	F
		M	WR F	250	2001	2001	F
		M	WR F	250	2002	2013	F
		M	WR F EFI	250	2015		F
		M	YZ	250	2001	2002	F
		M	YZ	250	2002	2007	F
		M	YZ F	250	2001	2001	F
		M	YZ F	250	2002	2006	F
		M	YZ F EFI	250	2014	2015	F
		M	YZ- WR	250	1998		F
		M	WR F	400	2001	2002	F
		M	WR F	426	2001	2002	F
		M	YZ-F	426	2001	2002	F
		M	WR F	450	2003	2015	F
		M	YZ-F	450	2003	2007	F
FMD0029	TM	M	all models	125		1985	F
		M	GS- MC	125	1990	1992	F
	YAMAHA	M	DT R	125	1988	2003	F
		M	DT-Z TENERE	125	1989	1990	F
		M	WR	125	1989	1990	F
		M	YZ	125	1985	1989	F
		M	DT R	200	1988	1991	F
		M	YZ	250	1985	1990	F
		M	TT	350	1985	1995	F
		M	WR Z	500	1992	1993	F
		M	TT	600	1989	1992	F
		M	TT N	600	1985	1988	F
FMD0030	YAMAHA	M	TZR R	50	1993	2002	F
		A	YFM BEAR TRACKER	250	2001	2004	F
		M	XTZ SUPER TENERE	750	1989	2000	F
FMD0033	HONDA	M	XRV AFRICA TWIN	750	1990	2002	F
		M	XRV R AFRICA TWIN	750	1990	1993	F
FMD0034	KYMCO	S	AGILITY	50	2005	2008	F
		S	AGILITY R12 (Rear Drum Model)	50	2007	2008	F
		S	DINK	50	1999	2001	F
		S	DINK LC	50	1998	2002	F
		A	MXER	50	2003		F
		S	SUPER 9	50	2000	2001	R
		S	SUPER 9 SPORT EURO 2	50	2003	2004	R

M = MOTORCYCLE
S = SCOOTER
A = ATV
Sn = SNOWMOBILE

FERODO
RACING
Updated on November 2020

13005



CC FROM TO FRONT / REAR

Code	Brand	Model	CC	FROM	TO	FRONT / REAR
...FMD0034	PEUGEOT	S TOP BOY ON / OFF ROAD	50	1996		F
		S VITALITY	50	2004		F
		S AGILITY 4T	125	2005	2008	F
		S AGILITY R12 (Rear Drum Model)	125	2005	2010	F
		S DINK	125	1996	1999	F/R
		S DINK CLASSIC	150	2002		R
		S DINK LX	150	1998	2000	F/R
M X RACE	50	2002	2005	R		
FMD0037	YAMAHA	M WR	125	1991	1997	F
		M YZ	125	1990	1997	F
		M WR Z	250	1991	1997	F
		M YZ	250	1990	1997	F
		M XT	350	1985	1990	F
		M YZ	360	1989		F
		M YZ RALLY	360	1990	1993	F
FMD0038	APRILIA	M PEGASO	650	1991	2000	F
		M PEGASO I.E.	650	2001	2004	F
		M PEGASO TRAIL	650	2005	2008	F
FMD0040	PIAGGIO	S HEXAGON	125	1994	1997	F
		S HEXAGON	150	1994	1999	F
FMD0042	MALAGUTI	S F10	50	1992	1998	F
		S F10 AC	50	2008		F
		S F10 RESTYLING	50	2001	2006	F
		S YESTERDAY	50	1998		F
		MOTRON S COMPACT RACING ES	50	1988	1992	F
		PEUGEOT S ZENITH	50	1994	1995	F
		S ZENITH	50	1996		F
FMD0043	DERBI	S GP1 OPEN	50	2005	2011	F
		GILERA S RUNNER 2T	50	2014	2016	F
	S RUNNER PURE JET ST	50	2008		F	
		S RUNNER SP ST	50	2008		F
	PIAGGIO S FLY 4T 4V i.e.	50	2012	2017	R	
		S LIBERTY 2T	50	1997	2011	F
	S LIBERTY 4T	50	2000	2009	F	
	S NRG DD 2T	50	2006	2013	F	
	S NRG DT POWER	50	2005	2013	F	
	S NRG POWER DD	50	2005	2014	F	
	S NRG POWER DT	50	2005	2013	F	
	S NRG POWER PUREJET	50	2004	2011	F	
	S NRG PUREJET	50	2004	2010	F	
	S NRG SILVER BULLET	50	2010	2010	F	
	S FREE	100	2001		F	
	S FLY 125 4T 3V	125	2012	2017	R	
	S LIBERTY 2T	125	1998	2002	F	
	S LIBERTY 4T	125	2006	2008	F	
	S LIBERTY 4T S	125	2006	2008	F	
	S LIBERTY 4T SPORT	125	2006	2009	F	
	S SUPER HEXAGON GTX	125	2001	2002	R	
	S VESPA 946 4T/3V ABS	125	2013	2019	F	
	S VESPA 946 4T/3V ARMANI	125	2014	2017	F	
	S VESPA 946 RED 4T/3V ABS	125	2017	2019	F	
	S VESPA GRANTURISMO L (pinza Grimeca)	125	2003		F/R	
	S VESPA GRANTURISMO L (pinza HengTong)	125	2003		F/R	
	S VESPA GTS	125	2007	2012	F/R	
	S VESPA GTS 4T i.e. ABS E4	125	2016	2018	F/R	
	S VESPA GTS 4T SUPER i.e.	125	2008	2016	F/R	
	S VESPA GTS 4T SUPER i.e. ABS	125	2014	2016	F/R	
	S VESPA GTS SUPERSPORT i.e.	125	2013	2016	F/R	
	S VESPA GTS TOURING ABS	125	2018		F/R	
	S Vespa GTV	125	2006	2008	F/R	
	S LIBERTY 4T	150	2008	2013	F	
	S LIBERTY 4T SPORT	150	2008	2008	F	
	S LIBERTY LE 4T	150	1999	2003	F	
	S VESPA 150 GTS i.e. ABS E4	150	2016	2017	F/R	
	S SUPER HEXAGON GTX	180	2001	2004	R	
	S LIBERTY	200	2006		F	
	S LIBERTY 4T EURO3	200	2007	2008	F	
	S LIBERTY 4T SPORT EURO 3	200	2006	2007	F	
	S LIBERTY RST	200	2004	2005	F	
	S LIBERTY SPORT	200	2006		F	
	S VESPA GRANTURISMO (pinza Grimeca)	200	2006		F/R	
	S VESPA GRANTURISMO (pinza Heng Tong)	200	2006		F/R	
	S VESPA GRANTURISMO L (pinza Grimeca)	200	2003	2005	F/R	
	S VESPA GRANTURISMO L (pinza Heng Tong)	200	2003	2005	F/R	
	S VESPA GT 60	250	2006	2007	F/R	
	S VESPA GTS	250	2005	2014	F/R	
	S VESPA GTV	250	2006		F/R	
S VESPA GTS 300	300	2010	2019	F/R		



CC FROM TO FRONT / REAR

Code	Brand	Model	CC	FROM	TO	FRONT / REAR		
FMD0045	MBK	S VESPA GTS 300 ABS - ASR NOTTE	300	2018	2019	F/R		
		S VESPA GTS 300 ABS - ASR YACHT CLUB	300	2018	2019	F/R		
		S VESPA GTS 300 HPE	300	2019		F/R		
		S VESPA GTS 300 i.e. Touring	300	2010	2019	F/R		
		S VESPA GTS 300 i.e. Touring HPE	300	2019		F/R		
		S VESPA GTS 300 Super HPE	300	2019		F/R		
		S VESPA GTS 300 Super i.e.	300	2008	2019	F/R		
		S VESPA GTS 300 Super Sport	300	2010	2019	F/R		
		S VESPA GTS 300 Super Sport HPE	300	2019		F/R		
		S VESPA GTS 300 SUPER TECH Hpe	300	2019		F/R		
		S VESPA Sei Giorni	300	2017	2019	F/R		
		S CW BOOSTER SPIRIT	50	1999		F		
S CW L BOOSTER	50	2001		F				
S CW RS BOOSTER NG	50	1995	1998	F				
S CW RSP BOOSTER ROCKET	50	1997	1998	F				
S CW RSX TRACK	50	1996	1998	F				
FMD0046	MALAGUTI	S MADISON S	250	1999	2001	F		
		S MADISON K	400	2002		R		
		S MADISON K RESTYLING	400	2002	2004	R		
FMD0047	MALAGUTI	S CIAK	50	1999	2000	F		
		S CIAK MASTER	50	2004	2005	F		
		S CIAK MASTER 4T	50	2005	2006	F		
		S CIAK MASTER EURO 2	50	2006		F		
		S CIAK MONO EURO 2,3	50	2003		F		
		S CIAK TD	50	2000	2001	F		
		S CIAK TWIN DISK	50	2002		F		
		S CIAK	100	1999	2001	F		
		S CIAK	125	2000	2001	F		
		S CIAK MASTER	125	2004		F		
		S CIAK MASTER EURO 3	125	2006		F		
		S CIAK RESTYLING	125	2003		F		
S CIAK	150	2000	2002	F				
S CIAK MASTER	150	2003		F				
S CIAK RESTYLING EURO 2	150	2004		F				
S CIAK MASTER EURO 2	200	2006		F				
FMD0048	MALAGUTI	S F12 PHANTOM LC	50	1999	2000	F		
		S F15 FIREFOX	50	1996	1997	F		
		S F15 FIREFOX L.C.	50	1999	2005	F		
		S PHANTOM MAX	100	1999		F		
		S F 18 WARRIOR	125	2000	2002	R		
		S F 18 WARRIOR	150	2000	2002	R		
		PEUGEOT S DJANGO HERITAGE	50	2014		F		
			S VIVACITY 4T	50	2008		F	
			S VIVACITY SIXTIES	50	2011		F	
		FMD0050	APRILIA	S SCARABEO	125	2004	2006	F
				S SCARABEO (motore Piaggio)	125	2003	2004	F
				S SCARABEO (motore Rotax)	125	1999	2003	F
S SCARABEO EU3	125			2006	2007	F		
S SCARABEO GT	125			1999	2003	F		
S SCARABEO i.e. LIGHT	125			2008	2009	F		
S SCARABEO LIGHT	125			2007	2008	F		
S SPORT CITY	125			2004	2005	F		
S SPORT CITY CUBE	125			2008	2010	F		
S SPORT CITY EU3	125			2006	2008	F		
S SCARABEO	150			1998	2003	F		
S SCARABEO GT	150			2004		F		
S SCARABEO	200			2001	2003	F		
S SCARABEO	200			2007	2010	F		
S SCARABEO (motore Piaggio)	200			2003	2006	F		
S SCARABEO GT	200			2002	2004	F		
S SPORT CITY	200			2004	2005	F		
S SPORT CITY CUBE	200			2009		F		
S SPORT CITY EU3	200			2006	2008	F		
S SCARABEO	250			2004	2006	F		
S SCARABEO i.e.	250			2006	2009	F		
S SCARABEO LIGHT	250			2006	2008	F		
S SPORT CITY CUBE	250			2008	2010	F		
S SPORT CITY EU3	250			2006		F		
S SCARABEO LIGHT	300			2006	2010	F		
S SCARABEO SPECIAL i.e.	300			2009	2012	F		
S SPORT CITY CUBE	300			2008		F		
S ATLANTIC SPRINT	400			2005	2008	F		
S SCARABEO LIGHT	400	2006	2008	F				
S SCARABEO URBAN	400	2006	2008	F				
S ARECIFE (spagna)	500	2002	2004	F				
S ATLANTIC	500	2002	2004	F				
S ATLANTIC SPRINT	500	2005	2008	F				
S SCARABEO	500	2002	2006	F				

13006

FERODO

RACING
Updated on November 2020

M = MOTORCYCLE
S = SCOOTER
A = ATV
Sn = SNOWMOBILE



CC FROM TO FRONT / REAR

Code	Brand	Model	CC	FROM	TO	FRONT / REAR		
...FMD0050	DERBI	S SCARABEO LIGHT	500	2006	2008	F		
		S SCARABEO URBAN	500	2006	2012	F		
		S BOULEVARD S	125	2007		F		
		S RAMBLA	125	2009	2011	F		
		S RAMBLA	250	2009		F		
	PIAGGIO	S RAMBLA i	300	2010	2012	F		
		S Medley 125 i-Get ABS	125	2016		F		
		S Medley 125 i-Get Sp. Edition ABS	125	2017		F		
		S Medley 150 i-Get Sp. Edition ABS	150	2017		F		
		FMD0051	APRILIA	M RS REPLICA	50	2000	2005	F
		M TUONO	50	2003	2004	F		
		M TUONO	50	2005		F		
FMD0053	APRILIA	S SCARABEO SPECIAL i.e.	300	2009	2012	R		
		S SR MAX i	300	2010	2016	R		
		S SCARABEO LIGHT	400	2006	2008	R		
		S SCARABEO URBAN	400	2006	2008	R		
		S SCARABEO URBAN	500	2006	2012	R		
		GILERA	S DNA	50	2000	2007	F	
			S DNA GP EXPERIENCE	50	2003	2004	F	
			S DNA	125	2001		F	
			S RUNNER FX - FXR	125	1997	2002	R	
			S RUNNER SP	125	1999		R	
	S RUNNER FXR		180	1998		R		
	S RUNNER SP		180	1999		R		
	ITALJET		S DRAGSTER	125	1999	2001	R	
			S DRAGSTER	180	1999	2001	R	
	PIAGGIO		S BEVERLY NEW i.e.	125	2016	2016	F	
		S BEVERLY S	125	2008	2010	F/R		
		S X9 EVOLUTION	125	2001	2007	F/R		
		S X9 AMALFI	180	2000	2003	F/R		
		S X9 EVOLUTION	200	2002	2003	F/R		
		S X9	250	2000	2003	F/R		
		S X9 AMALFI	250	2000		F/R		
		S X9 EVOLUTION	250	2004	2006	F/R		
		FMD0054	GILERA	S NEXUS	500	2003	2005	R
		PIAGGIO	M MP3 125	125	2006	2008	R	
			S MP3 IBRIDO	125	2009	2010	R	
			S MP3 IE	125	2008	2009	R	
	S MP3 IE TOURING		125	2011	2012	R		
	S MP3 YOURBAN ERL		125	2011	2013	R		
	S SUPER HEXAGON GTX		125	2001	2002	F		
	S X EVO		125	2004	2017	R		
	S X EVO SPORT		125	2015	2017	R		
	S X8		125	2004		R		
	S X8 (pinza HengTong)		125	2005	2006	R		
	S X8 PREMIUM EURO 2		125	2006		R		
	S SUPER HEXAGON GTX		180	2001	2004	F		
	S X8		200	2004	2005	R		
	S X8		200	2006		R		
	S X8 (pinza HengTong)		200	2005		R		
	S MP3		250	2006	2008	R		
	S MP3 LT		250	2008	2009	R		
	S MP3 MIC		250	2008	2009	R		
	S X EVO		250	2007	2013	R		
S X EVO SPORT	250		2015	2017	R			
S MP3 300 HPE	300		2019		R			
S MP3 4T 4V IE ERL IBRIDO	300		2010	2017	R			
S MP3 i.e. S YOURBAN	300		2018		R			
S MP3 IE LT	300		2010	2011	R			
S MP3 IE LT - IE LT SPORT	300		2011	2013	R			
S MP3 IE LT TOURING	300		2011	2013	R			
S MP3 IE MIC	300		2010	2013	R			
S MP3 IE TOURING	300		2011	2012	R			
S MP3 LT BUSINESS ABS	300		2014		R			
S MP3 SPORT ABS	300		2014		R			
S MP3 YOURBAN ERL	300		2011	2015	R			
S MP3 YOURBAN LT ERL	300		2011	2012	R			
S MP3 ABS/LT/SPORT	350		2018		R			
M BEVERLY EURO 3	400		2006	2008	R			
S MP3	400		2007	2008	R			
S MP3 IE LT - IE LT SPORT	400		2008	2010	R			
S MP3 IE LT TOURING	400		2011		R			
S MP3 LT	400		2009		R			
S MP3 MIC	400		2008	2010	R			
S MP3 RL TOURING	400		2011		R			
S X8	400		2006	2008	R			
S BEVERLY	500		2002	2006	R			
S BEVERLY CRUISER	500		2007	2012	R			



CC FROM TO FRONT / REAR

Code	Brand	Model	CC	FROM	TO	FRONT / REAR
FMD0055	APRILIA GILERA PIAGGIO	S BEVERLY EURO 3	500	2006		R
		S MP3 BUSSINESS HPE	500	2018		R
		S MP3 LT hpe BUSINESS	500	2016	2019	R
		S MP3 LT SPORT	500	2016	2018	R
		S MP3 TOURING SPORT / BUSINESS	500	2012	2015	R
		S MP3 TOURING SPORT hpe ABS	500	2018		R
		S MP3 TOURING SPORT hpe ADVANCED ABS	500	2018		R
		S X9	500	2001	2003	R
		M X9 EVOLUTION	500	2003	2004	R
		S X9 EVOLUTION ABS	500	2006	2007	R
		S SR MAX i	300	2010	2016	F
		S NEXUS EURO 3	125	2007		F
		S NEXUS IE EURO 3	125	2008	2011	F
		S NEXUS EURO 3	250	2006		F
		S NEXUS EURO 3	300	2008	2011	F
		S NEXUS EURO 3	500	2006	2011	F
S NEXUS SP EURO 3	500	2006	2007	F		
S BEVERLY	125	2001	2007	F/R		
S BEVERLY EURO 3	125	2007	2008	F/R		
S BEVERLY EURO 3 MIC	125	2007	2007	F/R		
S BEVERLY EURO 3 SPORT	125	2007	2010	F/R		
S BEVERLY EURO 3 TOURER	125	2008	2010	F/R		
S BEVERLY RST	125	2004	2007	F/R		
S BEVERLY RST 4T 4V IE EURO 3	125	2010	2011	F/R		
S BEVERLY S	125	2007	2007	F/R		
S CARNABY	125	2007	2010	F/R		
S X EVO	125	2004	2017	F		
S X EVO SPORT	125	2015	2017	F		
S X7	125	2007	2009	F		
S X7 EURO3	125	2008	2009	F		
S X7 EVO IE EURO3	125	2009	2010	F		
S X8	125	2004		F		
S X8 (pinza HengTong)	125	2005	2006	F		
S X8 PREMIUM EURO 2	125	2006		F		
S X8 STREET EURO 3	125	2006		F		
S X8 STREET EURO 3	150	2006		F		
S BEVERLY	200	2001	2006	F/R		
S BEVERLY (pinza HengTong)	200	2001	2006	F/R		
S CARNABY	200	2007	2010	F/R		
S X8	200	2004	2005	F		
S X8	200	2006		F		
S X8 EVO	200	2005	2007	F		
S BEVERLY	250	2006	2007	F/R		
S BEVERLY CRUISER	250	2007	2009	F/R		
S BEVERLY EURO 3 IE	250	2006	2008	F/R		
S BEVERLY EURO 3 MIC	250	2007		F/R		
S BEVERLY EURO 3 TOURER	250	2008	2009	F/R		
S BEVERLY LEADER	250	2004		F/R		
S BEVERLY RST	250	2004	2005	F/R		
S BEVERLY SPORT	250	2006	2008	F/R		
S CARNABY	250	2008		F/R		
S X EVO	250	2007	2013	F		
S X EVO SPORT	250	2015	2017	F		
S X7 EURO 3	250	2008		F		
S X8	250	2005		F		
S BEVERLY TOURER EURO 3	300	2009	2010	F/R		
S CARNABY CRUISER	300	2008	2013	F/R		
S X7 EVO IE	300	2011		F		
S X7 EVO IE EURO3	300	2009	2011	F		
S BEVERLY TOURER EURO3	400	2008	2010	F		
S X8	400	2006	2008	F		
S BEVERLY	500	2002	2006	F		
S BEVERLY CRUISER	500	2007	2012	F		
S BEVERLY EURO 3	500	2006		F		
S X9	500	2001	2003	F		
FMD0057	HONDA	S @ NES (tamburo post/rear drum)	125	2000	2008	F
		S DYLAN	125	2001	2007	F
		S PS i	125	2006	2013	F
		S SH/SH i (tamburo post/rear drum)	125	2000	2010	F
		S @ NES (tamburo post/rear drum)	150	2000	2008	F
		S DYLAN SES	150	2001	2006	F
		S PS i	150	2006	2008	F
		S SH/SH i (tamburo post/rear drum)	150	2000	2008	F
FMD0059	HONDA	M XRV AFRICA TWIN	750	1990	2002	R
		M XRV R AFRICA TWIN	750	1990	1993	R
		M XLV VARADERO	1000	1999	2002	R
FMD0064	BETA	M REV 3	125	2000	2008	F
		M REV 3	200	2000	2008	F

M = MOTORCYCLE
S = SCOOTER
A = ATV
Sn = SNOWMOBILE



CC FROM TO FRONT / REAR

...			CC	FROM	TO	FRONT / REAR
FMD0064		M	REV 3	250	2000	2008 F
		M	REV 3	270	2000	2008 F
FMD0073	HONDA	M	CX	500	1982	1985 F
FMD0075	BMW	M	R 850 C	850	1998	2001 R
		M	R 850 GS	850	1998	2007 R
		M	R 850 R	850	1994	2003 R
		M	R 850 R	850	2004	2007 R
		M	R 850 RT	850	1995	2001 R
		M	R 850 RT Integral ABS	850	2001	2004 R
		M	R 1100 GS	1100	1994	2001 R
		M	R 1100 R	1100	1995	2001 R
		M	R 1100 RT	1100	1994	2001 R
		M	R 1100 RT ABS	1100	1994	2001 R
		M	R 1100 S	1100	1998	2000 R
		M	R 1100 S	1100	2001	2006 R
		M	R 1100 S Boxer Cup Replika	1100	2003	2006 R
		M	R 1150 GS	1150	1999	2001 R
		M	R 1150 GS (Brebo caliper)	1150	2002	2004 R
		M	R 1150 GS ADVENTURE	1150	2002	2005 R
		M	R 1150 R	1150	2001	2006 R
		M	R 1150 R ROCKSTER	1150	2003	2006 R
		M	R 1150 RS	1150	2001	2005 R
		M	R 1150 RT	1150	2001	2005 R
		M	R 1150 RT ABS	1150	2001	2005 R
FMD0076	KAWASAKI	M	GPX	750	1987	1989 F
FMD0077	MOTO GUZZI	M	QUOTA	1000	1992	1997 F
FMD0078	GILERA	M	RC TOP RALLY	125	1989	F
FMD0080	BMW	M	R 45	450	1978	1986 F
		M	R 65	650	1978	1980 F
		M	R 65 LS	650	1982	1988 F
		M	R 65/1	650	1986	F
		M	PARIS DAKAR	800	1981	1987 F
		M	R 80 GS	800	1988	1990 F
		M	R 100	1000	1981	1989 F/R
		M	R 100 CS	1000	1981	1989 F
		M	R 100 RS	1000	1976	1980 F/R
FMD0081	BMW	M	K 75	750	1984	1996 F
		M	K 75 C	750	1985	1991 F
		M	K 75 RT	750	1990	1996 F/R
		M	K 75 S	750	1985	1988 F/R
		M	K 75 S	750	1989	1992 F
		M	K 75 S	750	1993	1996 F/R
		M	R 80	800	1981	1993 F
		M	R 80 GS Paris Dakar	800	1988	1994 F
		M	R 80 R ROADSTER	800	1992	1993 F
		M	R 80 RT	800	1985	1994 F
		M	K 100	1000	1983	1989 F/R
		M	K 100 LT ABS	1000	1990	1991 F/R
		M	K 100 LT LIMITED	1000	1991	1992 F/R
		M	K 100 RS	1000	1984	1989 F/R
		M	K 100 RS 16V	1000	1989	1993 R
		M	K 100 RT	1000	1984	1989 F/R
		M	K1	1000	1989	1993 R
		M	R 100 GS	1000	1987	1994 F
		M	R 100 GS MYSTIC	1000	1991	F
		M	R 100 GS PD	1000	1989	1995 F
		M	R 100 R	1000	1992	1996 F/R
		M	R 100 R ROADSTER	1000	1992	1995 F
		M	R 100 RT	1000	1991	1994 F
		M	K 1100 LT	1100	1992	2000 R
		M	K 1100 RS	1100	1993	1996 R
		M	R 1100 RS	1100	1994	2001 R
FMD0083	BMW	M	F 800 GT ABS	800	2013	2017 F
		M	F 800 R	800	2009	2019 F
		M	F 800 S	800	2006	2010 F
		M	F 800 ST	800	2006	2012 F
		M	R 850 R	850	2004	2007 F
		M	R 850 RT Integral ABS	850	2001	2004 F
		M	S 1000 R ABS	1000	2013	2019 F
		M	S 1000 XR	1000	2015	2019 F
		M	R 1100 S	1100	2001	2006 F
		M	R 1100 S Boxer Cup Replika	1100	2003	2006 F
		M	R 1150 R	1150	2001	2006 F
		M	R 1150 R ROCKSTER	1150	2003	2006 F
		M	R 1150 RS	1150	2001	2005 F
		M	R 1150 RT	1150	2001	2005 F
		M	R 1150 RT ABS	1150	2001	2005 F
		M	HP2 Megamoto	1200	2007	2010 F



CC FROM TO FRONT / REAR

			CC	FROM	TO	FRONT / REAR
		M	HP2 SPORT	1200	2008	2011 F
		M	K 1200 GT ABS	1200	2002	2007 F
		M	K 1200 LT ABS	1200	2001	2009 F
		M	K 1200 R	1200	2004	2008 F
		M	K 1200 RS	1200	2001	2006 F
		M	K 1200 S / ABS	1200	2004	2007 F
		M	R 1200 R	1200	2006	2017 F
		M	R 1200 R CLASSIC	1200	2011	2012 F
		M	R 1200 RS	1200	2015	2018 F
		M	R 1200 RT	1200	2005	2013 F
		M	R 1200 RT	1200	2014	2018 F
		M	R 1200 S	1200	2006	2008 F
		M	R 1200 ST	1200	2005	2008 F
		M	R NINE T	1200	2014	2019 F
		M	R NINE T PURE	1200	2014	2019 F
		M	R NINE T RACER	1200	2014	2019 F
		M	R NINE T SCRAMBLER	1200	2017	2019 F
		M	R NINE T URBAN G/S	1200	2017	2019 F
		M	K 1300 GT	1300	2009	2010 F
		M	K 1300 R - ABS	1300	2008	2014 F
		M	K 1300 S	1300	2009	2015 F
		M	K 1600 B	1649	2017	2019 F
		M	K 1600 B Grand America	1649	2018	F
		M	K 1600 GT	1649	2011	2019 F
		M	K 1600 GTL	1649	2011	2019 F
		M	K 1600 GTL EXCLUSIVE	1649	2014	2017 F
	HUSQVARNA	M	NUDA	900	2012	2013 F
		M	NUDA R	900	2012	2013 F
		M	NUDA R ABS	900	2013	F
FMD0085	HARLEY D.	M	XLH 883 SPORTSTER	883	1985	1999 F
		M	XL 1000	1000	1978	F
		M	XLS 1000 ROADSTER	1000	1979	1984 F
		M	XLH 1200 SPORTSTER	1200	1987	1999 F
		M	XLH 1200 SPORTSTER SPORT	1200	1996	1999 F
		M	FLH 1340 80	1340	1981	1984 F
		M	FLH 1340 81	1340	1987	1999 F
		M	FLH 1340 82	1340	1987	1999 F
		M	FLH 1340 83	1340	1989	1999 F
		M	FLH 1340 ELECTRA GLIDE	1340	1982	1983 F
		M	FLSTC 1340 HERITAGE SOFTAIL CLASSIC	1340	1989	1999 F
		M	FLSTC FAT BOY	1340	1989	1999 F
		M	FLSTC HERITAGE SOFTAIL CLASSIC	1340	1989	1999 F
		M	FLSTF FAT BOY	1340	1989	1999 F
		M	FXDWG DYNA WIDE GLIDE	1340	1993	1998 F
		M	FXLR 1340 LOW RIDER CUSTOM	1340	1987	1999 F
		M	FXR 1340 SUPER GLIDE	1340	1982	1999 F
		M	FXRS 1340 LOW RIDER SPORT	1340	1987	1999 F
		M	FXRT 1340 SPORT GLIDE	1340	1987	1999 F
		M	FXSTC SOFTAIL CUSTOM	1340	1989	1993 F
		M	FXSTC SOFTAIL CUSTOM	1340	1994	1995 F/R
		M	FXSTC SOFTAIL CUSTOM	1340	1996	1999 F
		M	FXSTS 1340 SPRINGER SOFTAIL	1340	1989	1999 F
		M	FLHR/I ROAD KING	1450	1998	1999 F
		M	FLHT/I ELECTRA GLIDE STANDARD	1450	1998	1999 F
		M	FLTR/I ROAD GLIDE	1450	1998	1999 F
		M	FXDS DYNA SUPER GLIDE SPORT	1450	1998	1999 F
		M	FXDWG DYNA WIDE GLIDE	1450	1993	1999 F
		M	FXRS SPORT GLIDE	1450	1984	1986 F
FMD0087	HONDA	M	CB	350	1987	F
		M	CB S	450	1985	1989 F
		M	XL V TRANSALP	600	1997	1999 F
		M	NX DOMINATOR	650	1988	1992 F
		M	NX DOMINATOR	650	1993	2004 F
		M	NX DOMINATOR 34 HP	650	1997	2002 F
		M	XL V TRANSALP	650	2000	2007 F
		M	XR L	650	1993	2012 F
		M	XL V TRANSALP	700	2008	2011 F
		M	XL V TRANSALP ABS	700	2008	2011 F
FMD0088	HONDA	M	XBR S	500	1985	1989 F
		M	XL V TRANSALP	600	1991	1996 F
		M	XL V TRANSALP (Rear Drum Model)	600	1987	1990 F
		M	SLR	650	1996	1996 F
		M	SLR	650	1997	1998 F
		M	SLR	650	1999	1999 F
FMD0089	CAGIVA	M	CANYON	500	1996	2000 F
		M	CANYON	600	1995	1999 F
		M	ELEFANT	750	1994	1995 F
		M	ELEFANT I.E. - GT - AC	900	1991	1994 F

13008

FERODO

RACING

Updated on November 2020

M = MOTORCYCLE
S = SCOOTER
A = ATV
Sn = SNOWMOBILE



CC FROM TO FRONT / REAR

Code	Brand	Model	CC	FROM	TO	FRONT / REAR		
...FMD0089	HONDA	M GRAN CANYON	900	1999	2004	F		
		M NAVIGATOR	1000	2000	2005	F		
		M XR V AFRICA TWIN	650	1988	1990	F		
FMD0090	HONDA	M CBR R	125	2003	2011	R		
		M CBR R	125	2012	2017	R		
		M XLV VARADERO	125	2001	2011	R		
		M SL	230	1997	2001	R		
		M CB F HORNET	250	1996	2001	R		
		M CRF L	250	2013	2014	R		
		M CRM R	250	1991	1993	R		
		M XR R	250	1991	2004	R		
		M XR R, S	250	1994		R		
		M CB	400	1989	1991	R		
		M XR R	400	1995	2005	R		
		M XR R	400	2006	2007	R		
		M XR SUPERMOTARD	400	2000	2007	R		
		M XR R	440	2006	2007	R		
		M XR R	500	1983	1986	F		
		M XR R	600	1991	1999	R		
		M XR R	600	2000	2000	R		
FMD0091	HONDA	M MTX R	80	1987		F		
		M CR R	125	1989	1994	F		
		M XLR	125	1993		F		
		M XLR R	125	1997	2003	F		
		M CR R	250	1989	1994	F		
		M CRM R	250	1991	1993	F		
		M CRM R	250	1994	1996	F		
		M XL R	250	1984	1992	F		
		M XR R	250	1986	1988	F		
		M XL R	350	1985		F		
		M XL X	350	1989		F		
		M XR R	350	1983	1984	F		
		M CR E	500	1988	1988	F		
		M CR R	500	1990	1994	F		
		FMD0092	KYMCO	S B&W EURO 2	50	2003		F
				S DINK	50	1997	1998	F
				S DINK	125	2000	2005	F
S GRAND DINK	125			2001	2004	F		
S MOVIE	125			1999	2000	F		
S MOVIE EURO 3	125			2006	2007	F		
S MOVIE XL	125			2001	2004	F		
S DINK CLASSIC	150			2002		F		
S DINK CLASSIC EURO 2	150			2003		F		
S GRAND DINK	150			2001	2004	F		
S MOVIE EURO 3	150			2006	2007	F		
S MOVIE XL	150			2001	2004	F		
S DINK CLASSIC	200			2004		F		
S B&W BET & WIN	250			2000	2002	F		
S B&W EURO 2	250			2003		F		
S GRAND DINK	250			2001	2002	F		
S GRAND DINK EURO 2	250			2003	2004	F		
S YUP	250	2003		F				
FMD0093	CAGIVA HONDA	M ELEFANT I.E.	900	1990	1992	F		
		S NEW LEAD	107	2008		F		
		M VTZ XELVIS	250	1992		F		
		M XELVIS V-25	250	1997		F		
		M CB	500	1994	1996	F		
		M CB	500	1997	2003	F		
		M CBF ABS	500	2004	2008	F		
		M CBF	600	2003	2007	F		
		M CBF N	600	2004	2007	F		
		M NTV DEAUVILLE	650	1998	2005	F		
		M NTV DEAUVILLE	680	2006	2012	F		
		M CB F	750	1983	1984	F		
		M CB N SEVEN FIFTY	750	1992	2002	F		
		M VFR F	750	1990	1993	F		
		M VFR F INTERCEPTOR	750	1988	1989	F		
		M VT 750 Shadow Black Spirit	750	2010	2012	F		
		M VT BLACK WINDOW	750	2001	2004	F		
		M VT C SHADOW	750	1986	2009	F		
		M VT C2 SHADOW A.C.E.	750	1997	2008	F		
		M VT SHADOW (RC50)	750	2004	2008	F		
		M CBR F	1000	1987	1992	F		
		M CBR F-PP	1000	1993	1999	F		
		M ST PAN EUROPEAN	1100	1989	1989	F		
		M ST PAN EUROPEAN	1100	1990	1995	F		
		M ST PAN EUROPEAN ABS	1100	1992	1995	F		
		M ST PAN EUROPEAN ABS	1100	1996	2001	F		



CC FROM TO FRONT / REAR

Code	Brand	Model	CC	FROM	TO	FRONT / REAR
FMD0094	HONDA	M VT 1300 CX	1300	2010	2012	R
		M CR R	80	1997	2002	F
		M CR	85	2003	2007	F
FMD0095	HONDA	M CRF R	150	2007	2015	F
		M CR R - E	125	1995	2001	F
		M CR R - E	125	2002	2007	F
		M CRF	230	2004	2009	F
		M CR R - E	250	1995	1996	F
		M CR R - E	250	1997	2001	F
		M CR R - E	250	2002	2010	F
		M CRE IE	250	2007	2008	F
		M CRF R	250	2004	2014	F
		M CRF X	250	2004		F
		M CRE IE	290	2007	2008	F
		M CRF X	300	2008	2012	F
		M CRF EFI	450	2009	2012	F
		M CRF R	450	2002	2014	F
		M CRF R EFI	450	2013	2014	F
		M CRF X	450	2004	2007	F
		M CR R	500	1995	2001	F
M CR R	500	2002		F		
FMD0096	HONDA	M NTV DEAUVILLE	650	1998	2005	R
		M NTV DEAUVILLE	680	2006	2012	R
		M CBX F	750	1983	1988	R
		M PACIFIC COAST	800	1989	1992	F
		M CB F Big one	1000	1993	1995	R
		M CBR F	1000	1987	1992	R
		M VT SHADOW ACE-AERO-C2-C3	1100	1995	1998	R
		M CB	1300	1998	2000	R
		M CB	1300	2001	2002	R
		M CB X4	1300	1997	2000	R
FMD0097	ADLY BENELLI CPI DAELIM HONDA KEEWAY KSR MOTO BY GENERIC MASH MBK	S PREDATOR	50			F
		S SS SUPERSONIC	50	2004	2005	F
		S TB THUNDERBIKE	50	2008	2009	F
		S SUPER SONIC	100	2004	2005	F
		S SUPER SONIC ALL MODELS	125	2001	2005	F
		S 491 all models	50	1997		F
		M GRIDO	50	2012	2013	F
		S K2 all models	50	1998		F
		S K2	100	1999		F
		S NAKED	100	1999	2002	F
		S ARAGON ALL MODELS	50	2006	2009	F
		S BABY / BAB J	50	2002		F
		S FORMULA BASCI / R	50	2004		F
		S HUSSAR ALL MODELS / MARS	50	2001		F
		S OLIVER / CITY / SPORT	50	2003	2012	F
		S OLIVER CITY	125	2006	2007	F
		M S-Five 50	50	2006	2010	F
		M AROMA	125	2016		F
		M BESBI	125	2011	2012	F
		S SKY	50	1997		F
		S SKY VETRO	50	2000		F
		S YUPI	50	1990		F
		S BALI SJ	100	1996		F
		S CH SPACY	125	1998		F
		S RY6 50	50	2017		F
		S URBAN BLADE 4T	50	2018		F
		S X-BLADE	50	2017		F
		S Epico electric		2012	2013	F
		S CRACKER 2T / 4T	50	2009	2015	F
		S Epico 50	50	2012	2017	F
		S IDEO / XOR 2T	50	2005	2014	F
		M Race 2 50 (2T/4T)	50	2010	2014	F
		S ROC / SIRION 2T / 4T	50	2008	2011	F
S TRIGGER	50	2002		F		
S Vertigo 50 4T	50	2012	2014	F		
S SIRION 4T	125	2002	2014	F		
S XOR	125	2005	2011	F		
S BIBOP / BIBOP RACING	50	2014	2015	F		
S SIXTY FIVE	125	2013	2015	F		
S BOOSTER 50 NAKED 13	50	2013	2017	F		
S CW BOOSTER NG	50	1995	1998	F		
S CW RS BOOSTER NG	50	1999	2003	F		
S EW STUNT	50	2000	2002	F		
S STUNT	50	2000	2006	F		
S STUNT NAKED	50	2005	2010	F		
S YQ NITRO	50	1997	2003	F/R		
S YQ NITRO	100	2000	2002	F		

M = MOTORCYCLE
S = SCOOTER
A = ATV
Sn = SNOWMOBILE



CC FROM TO FRONT / REAR

Code	Brand	Model	Capacity	Year	Front	Rear	
FMD0097	MOTO ROMA	S GRAND PRIX	50	1999	2003	F	
		S GRAND PRIX	100	1999	2003	F	
		S GRAND PRIX	125	2002		F	
		PEUGEOT	S METAL X 50	50	2002	F	
			S Streetzone 10	50	2014	2018	F
			S Streetzone 12	50	2017	2018	F
			S VIVACITY CATALITICO	50	2002	2004	F
		S VIVACITY VSX -XR	50	2002	2004	F	
		PGO	S LOOXOR	100	2001		F/R
			S I-CHARGE	50	2001	2002	F
	S PMS		50	1999	2003	F	
	S PMX		50	2000	2007	F/R	
	S T REX		50	1999	2017	F	
	S TR3		50	2003	2004	F	
	S BUBU		100	2003	2008	F	
	S PMS		110	1999		F	
	S PMX		110	2000	2007	F	
	S T REX		110	1999		F	
	RIEJU	S BUBU	125	2003	2008	F	
		S CHARGE A / B	125	2001	2002	F	
		S LIGERO 2T	125	2006	2008	F	
		S T-REX	125	1999	2016	F	
		S BLAST URBAN	50	2016	2018	F	
		S RS BLAST URBAN	50	2014	2018	F	
		S RS SPORT / NAKED	50	2014	2018	R	
		SINNIS	S LJ QT-H	50	2012	2014	F/R
			S XPro	50	2012	2017	F
		SYM	S FIDDLE III	200	2014	2015	F
	S FIDDLE III i ABS		200	2016	2019	F	
	TGB		S 101 R	50	2004	2009	F
			S 202 CLASSIC	50	2003	2014	F
	S 303 R LASER / R HAWK		50	2004	2014	F	
	S 303 REVOLUTION / RS		50	2002	2003	F	
	S AKROS TEC		50	1994	2004	F	
	S BULLET R X		50	2017	2018	F	
	S CITY 2T / 4T		50	2007		F	
	S DELIVERY / EXPRESS		50	2004	2012	F	
	S EXPRESS	50	2017	2018	F		
	S F409 CRUISE	50	2002	2005	F		
	S HIGH WHEEL / TRIGGER	50	2002	2003	F		
	S HIW'S	50	1999		F		
	S KEY WEST 2T	50	2006	2015	F		
	S AKROS / HIW'S	90	1999		F		
	S 202 T / 303 R	125	1999		F		
	S 303 REVOLUTION	125	2002	2003	F		
	S 309 RS	125	2000		F		
	S EXPRESS	125	2017	2018	F		
	S F409 CRUISE	125	2002	2005	F		
	S 303 R / 309 RS	150	2000		F		
	TORROT	S MUVI BUSINESS		2019		R	
S MUVI CITY EDITION / EXECUTIVE			2016	2017	R		
YAMAHA	S AEROX 4 4T	50	2018	2018	F/R		
	S AEROX R 2T	50	2018	2018	F/R		
	S AEROX R 4T ST	50	2019		F/R		
	S AEROX YQ 50 2T	50	1997	2017	F/R		
	S JOG R	50	2002	2011	F		
	S JOG R (Rear Drum Model)	50	2002	2011	F		
	S NEO'S	50	2007	2018	F		
	S NEO'S 4	50	2009	2018	F		
	S NEO'S 4T	50	2019		F		
	S SLIDER	50	1999		F/R		
S AEROX YQ 100	100	2000	2002	F			
FMD0098	HONDA	M GL GOLD WING	1100	1982	1983	F/R	
		M GL GOLDWING	1500	1988	1989	F	
		M GL GOLDWING	1500	1990	2000	F	
		M GLX	1500	1988		F	
FMD0100	HUSQVARNA KTM	M CR	65	2010	2014	F	
		M SX	65	1998	2018	F	
		M SXS	65	2012	2013	F	
		M XC	65	2008	2009	F	
		M MX	80	2000	2002	F	
FMD0101	KAWASAKI	M ZX	400	1988	1989	F	
		M GPZ S	500	1989	2006	F	
		M GPZ R	600	1984	1990	F	
		M ZX	600	1988	1990	F	
		M GPZ R	750	1985	1987	F	
		M GPZ UNITRAK	750	1983	1984	F	
		M GPZ UNITRAK	750	1985	1988	F	



CC FROM TO FRONT / REAR

Code	Brand	Model	Capacity	Year	Front	Rear		
FMD0103	KAWASAKI	M Z 750TURBO	750	1984	1986	R		
		M ELIMINATOR	900	1985	1987	R		
		M GPZ NINJA	900	1984	1986	R		
		M GPZ R	900	1984	1989	R		
		M ELIMINATOR	1000	1986	1990	R		
		M GTR	1000	1986	1993	F		
		M ZL	1000	1986	1988	R		
		M KLR	570	1984	1991	F		
		M KLR	600	1984	1986	F		
		M KLR ELECTRIC STARTER	600	1985	1994	F		
		M KLR S	600	1990	1992	F		
		FMD0104	KAWASAKI	M EL	250	1990		F
				M EX R NINJA	250	1986	1987	F
M GPZ TURBO	750			1983	1985	R		
FMD0105	KAWASAKI	M GPZ UNITRAK	750	1983	1984	R		
		M KLE	500	1991	2007	F		
FMD0106	KAWASAKI	M KX	80	1993	2000	F		
		M KX	85	2001	2015	F		
		M KX	100	2001	2014	F		
FMD0110	MBK	S XN DOODO	125	2000	2001	F		
		S YP SKYLINER	125	1998	2000	F		
		S YP SKYLINER	125	2001		F		
		S SKYLINER	150	1998	2000	F		
		S SKYLINER	150	2003	2010	F		
		S XN DOODO	150	2001		F		
		S YP SKYLINER	150	2000	2000	F		
		S YP SKYLINER	150	2001	2002	F		
		S YP E SKYLINER	180	2003		F		
		YAMAHA	S MAJESTY YP	125	1998	2000	F	
			S MAJESTY YP E	125	2001	2009	F	
			S TEO'S XN	125	1999	2002	F	
			S YP MAJESTY	125	1998	2009	F	
			S MAJESTY YP	150		2000	F	
S MAJESTY YP	150		2001	2002	F			
S MAJESTY YP E	150			2002	F			
S MAJESTY YP E	180	2003	2006	F				
FMD0111	APRILIA	M AF1 FUTURA	125	1990	1992	F		
		M MX	125	2004	2007	F		
		M RS	125	1995	1995	F		
		M RS	125	1996	2011	F		
		M RS EXTREMA	125	1992	1997	F		
		M RS REPLICA	125	1992	1997	F		
		M TUONO	125	2003	2004	F		
		M TUONO	125	2005	2007	F		
		M PEGASO FACTORY	650	2007	2009	F		
		M PEGASO STRADA	650	2005	2009	F		
		M DORSODURO	750	2008	2017	F		
		M DORSODURO FACTORY	750	2010	2013	F		
		M SHIVER GT	750	2009		F		
		M SL SHIVER	750	2007	2017	F		
		M MANA	850	2007	2011	F		
		M MANA GT	850	2009	2016	F		
		M DORSODURO ABS	900	2017		F		
		M SHIVER ABS	900	2017		F		
		M RST FUTURA	1000	2001	2004	F		
		M RSV	1000	1998	2000	F		
M RSV R	1000	2000	2001	F				
M RSV SP	1000	1999	2000	F				
M SL 1000 FALCO	1000	2000	2004	F				
M TUONO FIGHTER	1000	2002	2005	F				
M TUONO R (2 pads per caliper)	1000	2002	2009	F				
M TUONO V4 R	1000	2011	2013	F				
M TUONO V4 R APRC	1000	2011	2013	F				
M TUONO V4 R APRC ABS	1000	2014		F				
M CAPONORD	1200	2013	2014	F				
M CAPONORD	1200	2015	2017	F				
M CAPONORD TRAVEL PACK ABS	1200	2016	2017	F				
M DORSODURO	1200	2011	2013	F				
M DORSODURO ABS	1200	2011	2012	F				
BENELLI	M LEONCINO	500	2017	2018	F			
	M BN 600	600	2015	2017	F			
	M BN 600 GT	600	2015	2017	F			
	M CENTURY RACER	899	2011	2015	F			
	M TNT	899	2008	2016	F			
	M TNT S	899	2008	2011	F			
	M TRE K	899	2011	2016	F			
	M TORNADO TRE	900	2001	2002	F			
	M TNT	1100	2004		F			

13010

FERODO
RACING
Updated on November 2020

M = MOTORCYCLE
S = SCOOTER
A = ATV
Sn = SNOWMOBILE



FRONT
/ REAR
CC FROM TO

...FMD0111

		CC	FROM	TO	FRONT / REAR	
	M	CENTURY RACER	1130	2011	2014	F
	M	TNT	1130	2004	2006	F
	M	TNT R160	1130	2011		F
	M	TRE K	1130	2007	2017	F
BIMOTA	M	YB7	400	1989		F
	M	V-DUE	500	1997	2000	F
	M	YB9	600	1997	2000	F
	M	BB1 SUPERMONO	650	1996	2000	F
	M	TESI 1D 851	851	1990	1991	F
	M	DB2 SR	904	1993	2000	F
	M	DB3 MANTRA	904	1995	2000	F
	M	DB4	904	1998	1999	F
	M	DIECI BIPOSTO	1000	1992	1995	F
	M	SB8K GOBERT	1000	2006		F
	M	SB8R	1000	1997	2000	F
	M	SB6	1100	1996	2000	F
	M	SB6R	1100	1998	2000	F
BMW	M	G 650 X Moto	650	2007	2009	F
CAGIVA	M	MITO	125	1991	1994	F
	M	MITO EV	125	1995	2007	F
	M	MITO SP525	125	2006	2010	F
	M	PLANET	125	1997	2007	F
	M	RAPTOR	125	2003	2010	F
	M	SUPERCITY	125	1992	2000	F
	M	RIVER	600	1995	1999	F
DUCATI	M	JUNIOR SS	350	1991	1993	F
	M	MONSTER	400	1994	1999	F
	M	MONSTER	400	2001	2006	F
	M	SS SUPERSPORT	400	1992	1997	F
	M	SS SUPERSPORT JUNIOR	400	1992	1997	F
	M	M MONSTER	600	1994	2002	F
	M	MONSTER	600	1994	2002	F
	M	SS SUPERSPORT	600	1994	2000	F
	M	MONSTER	620	2002	2005	F
	M	MONSTER single disk	620	2005	2006	F
	M	MULTISTRADA single disk	620	2005	2006	F
	M	SPORT	620	2003	2004	F
	M	SS SUPERSPORT	620	2002	2005	F
	M	MONSTER	696	2008	2014	F
	M	MONSTER ABS	696	2010	2014	F
	M	748 BIPOSTO	748	1995	2002	F
	M	748 R	748	2000	2000	F
	M	748 S	748	1999	2002	F
	M	748 SP	748	1995	1997	F
	M	748 SPS	748	1998	1999	F
	M	M MONSTER	750	1996	2001	F
	M	MONSTER	750	1994	2001	F
	M	SPORT	750	2000	2002	F
	M	SS SUPERSPORT	750	1991	2002	F
	M	MONSTER	800	2003	2004	F
	M	SPORT	800	2003	2004	F
	M	SS SUPERSPORT	800	2003	2005	F
	M	851 STRADA - SP	851	1988	1991	F
	M	888 DESMOQUATTRO	888	1993	1994	F
	M	888 SP	888	1990	1993	F
	M	M MONSTER	900	1993	2001	F
	M	MONSTER	900	1993	2004	F
	M	SL 900 SUPERLIGHT	900	1991	1997	F
	M	SPORT	900	2002		F
	M	SS SUPERSPORT	900	1991	2002	F
	M	916 BIPOSTO	916	1994	1998	F
	M	916 SP	916	1994	1996	F
	M	916 SPS	916	1997	1998	F
	M	MONSTER S4	916	2001	2003	F
	M	ST4	916	1998	2004	F
	M	ST2	944	1997	2003	F
	M	ST3	992	2004	2006	F
	M	996 BIPOSTO	996	1999	2001	F
	M	996 S	996	2001		F
	M	MONSTER S4R	996	2003	2006	F
	M	ST4 S	996	2001	2005	F
	M	ST4 S ABS	996	2003	2003	F
	M	998 BIPOSTO	998	2002	2003	F
	M	998 S (two pads)	998	2002	2003	F
	M	GT	1000	2006	2010	F
	M	GT TOURING	1000	2009		F
	M	MONSTER	1000	2003	2005	F
	M	MONSTER S	1000	2003	2005	F



FRONT
/ REAR
CC FROM TO

FMD0112

		CC	FROM	TO	FRONT / REAR	
	M	MONSTER S2R	1000	2006	2007	F
	M	PAUL SMART LE	1000	2006	2007	F
	M	SPORT	1000	2006	2008	F
	M	SPORT S	1000	2007	2009	F
	M	SS SUPERSPORT	1000	2003	2006	F
	M	ST3	1000	2004	2006	F
	M	ST3 S ABS	1000	2006	2007	F
GILERA	M	GFR	125	1993	1994	F
KTM	M	DUKE II	640	2003	2006	F
	M	DUKE	690	2008	2013	F
LAVERDA	M	GHOST	650	1996	1999	F
	M	SPORT	650	1995	2001	F
	M	S FORMULA	750	1998	2001	F
	M	STRIKE	750	1998	2001	F
MOTO GUZZI	M	BREVA	750	2003	2007	F
	M	NEVADA	750	2003	2007	F
	M	NEVADA	750	2012	2016	F
	M	V7 CLASSIC	750	2008	2013	F
	M	V7 II RACER ABS	750	2015	2016	F
	M	V7 II SPECIAL ABS	750	2015	2016	F
	M	V7 II STONE ABS	750	2015	2016	F
	M	V7 II STORNELLO ABS	750	2016	2017	F
	M	V7 III ANNIVERSARIO ABS	750	2017		F
	M	V7 III RACER ABS	750	2017		F
	M	V7 III SPECIAL ABS	750	2017		F
	M	V7 III STONE ABS	750	2017		F
	M	V7 RACER	750	2010	2014	F
	M	V7 SPECIAL	750	2012	2014	F
	M	V7 STONE	750	2012	2014	F
	M	BREVA	850	2006	2008	F
	M	GRISO	850	2006		F
	M	NORGE T-GTL	850	2007		F
	M	V9 BOBBER ABS	850	2016	2017	F
	M	V9 ROAMER ABS	850	2016	2017	F
	M	BELLAGIO	940	2007	2013	F
	M	DAYTONA IE	1000	1995	2000	F
	M	V10 CENTAURO	1000	1996	2001	F
	M	V10 CENTAURO SPORT	1000	1998	2000	F
	M	BREVA	1100	2005	2007	F
	M	CALIFORNIA EV	1100	1996	2000	F
	M	CALIFORNIA EV SPECIAL	1100	1997	2003	F
	M	CALIFORNIA JACKAL	1100	2001	2006	F
	M	GRISO	1100	2005	2008	F
	M	SPORT	1100	1996		F
	M	V10 CENTAURO SPORT	1100	1998	2000	F
	M	V11 LE MANS	1100	2000	2005	F
	M	V11 SPORT	1100	1997	2000	F
	M	BREVA	1200	2008	2009	F
	M	BREVA ABS	1200	2008	2009	F
	M	GRISO 8 V	1200	2007	2016	F
	M	NORGE GT 8V ABS	1200	2010	2016	F
	M	NORGE T-GTL	1200	2006	2006	F
	M	NORGE T-GTL ABS	1200	2006	2009	F
	M	SPORT 8V	1200	2008	2010	F
	M	SPORT 8V ABS	1200	2008	2013	F
	M	SPORT ABS	1200	2006	2007	F
	M	STELVIO	1200	2008	2014	F
	M	STELVIO ABS	1200	2009	2017	F
MOTO MORINI	M	9,5	1200	2006	2010	F
	M	CORSARO	1200	2005	2009	F
	M	CORSARO ZZ ABS	1200	2017	2018	F
MZ	M	1000 S	1000	2001	2003	F
VOXAN	M	BLACK MAGIC	995	2006	2008	F
	M	CAFE RACER	995	2000	2006	F
	M	ROADSTER	995	2001	2006	F
YAMAHA	M	TDR	125	1989	2001	F
	M	FZX ZEAL	250	1991	1992	F
	M	TDR	250	1988	1992	F
	M	TZR	250	1989	1992	F
	M	SRX	400	1991		F
	M	SZR	660	1995	2001	F
	M	FZR R	750	1989	1992	F
	M	FZR EXUP	1000	1990	1995	F
	M	FZR GENESIS	1000	1987	1989	F
	M	XJR	1200	1995	1996	F
	M	XJR	1200	1997		F
	M	XJR	1300	1998	1998	F
FMD0112	HONDA	RS GP	125	1991	2005	F

M = MOTORCYCLE
S = SCOOTER
A = ATV
Sn = SNOWMOBILE



CC FROM TO FRONT / REAR

Code	Brand	Model	CC	FROM	TO	FRONT / REAR		
...FMD0112		M RS R	125	1991	2005	F		
		M RS R GP	125	1991	2005	F		
		M CB F HORNET	250	1996	2001	F		
		M HORNET	250	1997		F		
		M RS GP	250	1990	1997	F		
		M RS R	250	1990	1997	F		
		M RS R GP	250	1990	1997	F		
		M TSR	250	1999		F		
		M CB N	400	1982	1988	F		
		M CBR F	400	1985	1987	F		
		M VFR R	400	1989	1993	F		
		M CBR F	600	1995	1998	F		
		M VFR F	750	1994	1997	F		
		M CBR RR	900	1994	1997	F		
		M VTR F FIRESTORM	1000	1997	2007	F		
		M VTR F SUPER HAWK	1000	1997	2007	F		
		FMD0113	HONDA	M CBR F	600	1999	2000	F
				M CROSSRUNNER	800	2011	2014	F
M VFR V-TEC	800			2002	2010	F		
M VFR V-TEC	800			2011	2013	F		
M VFR V-TEC ABS	800			2002	2013	F		
M CBR F	900			2003		F		
M CBR RR	900			1992	1993	F		
M XLV VARADERO	1000			1999	2002	F		
M XLV VARADERO	1000			2003	2011	F		
M XLV VARADERO ABS	1000			2004	2011	F		
M GL F6C VALKYRIE	1500			1997	2003	F		
M GL GOLD WING	1800			2001	2017	F		
M GOLD WING F6B	1800			2013	2017	F		
INDIAN	M ROADMASTER ABS			1811	2015	2016	F	
FMD0114	KAWASAKI			M ZXR	400	1991	2002	F
				M ZX7R NINJA	750	1989	1995	F
				M ZXR	750	1989	1995	F
				M ZXR R	750	1989	1992	F
		M ZX9R NINJA	900	2000	2001	F		
		M ZEPHYR	1100	1993	1995	F		
		M ZEPHYR	1100	1996	1998	F		
		M ZRX	1100	1997	2000	F		
		M ZZR	1100	1990	1992	F		
		M ZRX	1200	2001	2006	F		
		M ZRX R	1200	2001	2006	F		
		M ZRX S	1200	2001	2006	F		
		FMD0115	KAWASAKI	M ZZR	250	1992		F
				M ZXR	400	1989	1990	F
				M ZEPHYR	550	1993	2001	F
				M ELIMINATOR	600	1995	1999	F
				M ZX6R NINJA	600	1995	1997	F
				M ZX6R NINJA	600	1998	2001	F
M ZZR	600			1990	1992	F		
M ZZR	600			1993	2005	F		
M ZZR	600			2006	2006	F		
M ZX6R NINJA	636			2002	2002	F		
M Z 750	750			2004	2006	F		
M Z 750 S	750			2005	2006	F		
M ZEPHYR	750			1991	1999	F		
M ZR7	750			1999	2003	F		
M ZR7S	750			2001	2003	F		
M GPZ R	900			1990	2003	F		
M GTR	1000			1994	2006	F		
M Z 1000	1000			2003	2006	F		
M GPZ	1100			1995	1998	F		
M ZX12R NINJA	1200			2004	2006	F		
FMD0116	KAWASAKI			M ZX7R NINJA	750	1996	2003	F
		M ZX7RR NINJA	750	1996	2002	F		
		M ZX7RR NINJA	750	2003		F		
		M ZXR L	750	1993	1995	F		
		M ZXR R	750	1993	1995	F		
		M ZX9R NINJA	900	1994	1997	F		
		M ZX9R NINJA	900	2002	2003	F		
		M ZZR	1100	1993	1999	F		
		M ZX12R NINJA	1200	2000	2003	F		
		M ZZR	1200	2002	2005	F		
		M VN MEAN STREAK	1500	2002	2003	F		
		M VN MEAN STREAK	1600	2004	2007	F		
		FMD0117	SUZUKI	M GSX R	750	1989	1995	F
				M GSX R LIMITED EDITION	750	1989	1990	F
				M GSX R W	750	1994	1995	F
M GSX R	1100			1989	2000	F		



CC FROM TO FRONT / REAR

Code	Brand	Model	CC	FROM	TO	FRONT / REAR		
FMD0118	SUZUKI	M RG F GAMMA	125	1992	1994	F		
		M RGV GAMMA	250	1991	1997	F		
		M GSX	750	1997	2003	F		
		M VZ MARAUDER	800	1996	2004	F		
FMD0119	SUZUKI	M GSF BANDIT	250	1990		F		
		M GS	400	1989	1989	F		
		M GSF BANDIT	400	1989	1996	F		
		M GS E	500	1989	2003	F		
		M GS F	500	2004	2007	F		
		M RF	900	1994	1997	F		
FMD0120	SUZUKI	M GSF BANDIT	1200	1996	2005	F		
		M GSX INAZUMA	1200	1999	2002	F		
		M GSF BANDIT	600	1995	1999	F		
		M GSF BANDIT	600	2000	2004	F		
		M GSX F	600	1998	2003	F		
		M RF R	600	1993	1997	F		
FMD0121	SUZUKI	M SV	650	1999	2002	F		
		M SV S	650	1999	2002	F		
		M GSX F	750	1998	2003	F		
		CAGIVA	M FRECCIA C12R	125	1989	1991	F	
		DUCATI	M PASO 907 I.E.	904	1990	1991	F	
		INDIAN	M CHIEF CLASSIC ABS	1811	2015	2016	F	
FMD0122	SUZUKI	M CHIEF DARK HORSE ABS	1811	2015	2016	F		
		M CHIEF VINTAGE ABS	1811	2015	2016	F		
		M CHIEFTAIN ABS	1811	2015	2016	F		
		MOTO GUZZI	M DAYTONA IE	1000	1991	1994	F	
		MOTO MORINI	M GRANPASSO	1200	2008	2009	F	
		VICTORY	M BOARDWALK ABS	1731	2015	2016	F	
		M CROSS COUNTRY ABS	1731	2015	2016	F		
		M CROSS COUNTRY TOUR ABS	1731	2015	2016	F		
		M GUNNER ABS	1731	2015	2016	F		
		M HAMMER 8-BALL	1731	2015	2016	F		
		M HAMMER S	1731	2015	2016	F		
		M HIGH-BALL ABS	1731	2015	2016	F		
		M JUDGE ABS	1731	2015	2016	F		
		M MAGNUM ABS	1731	2015	2016	F		
		M VEGAS	1731	2015	2016	F		
		M VISION TOUR ABS	1731	2015	2016	F		
		M TZ COMPETITION	125	1996	1997	F		
		M R1-Z	250	1997		F		
M TZ GP	250	1996	1997	F				
M XJR	400	1995	2000	F				
FMD0123	SUZUKI	M FZR	600	1989		F		
		M FZR R	600	1990	1995	F		
		M FZS FAZER	600	1998	2003	F		
		M FZ GENESIS	750	1989	1992	F		
		M TDM	850	1991	2001	F		
		M TRX	850	1995	2000	F		
FMD0124	SUZUKI	M FJ	1200	1988	1991	F		
		M FJ ABS	1200	1991	1991	F		
		HONDA	M VFR R	750	1988	1991	F	
		M CB	1000	1993	1993	F		
		FMD0125	SUZUKI	M GSX R	600	1997	2003	F
				M GSX R	750	1996	2003	F
M GSX R Y	750			2000	2003	F		
M GSX R	1000			2001	2002	F		
M TL R	1000			1998	2003	F		
M TL S	1000			1997	2001	F		
FMD0126	SUZUKI	M GSX R HAYABUSA	1300	1999	2007	F		
		M GSX	1400	2002	2007	F		
		YAMAHA	M WR X	250	2008		F	
		M XJ DIVERSION S-N	600	1998		F		
		M XJ N	600	1998	2003	F		
		M XJ S DIVERSION	600	1998	2003	F		
FMD0127	SUZUKI	M YZF R THUNDERCAT	600	1996	2004	F		
		M YZF R6	600	1999	2002	F		
		M TDM	900	2002	2014	F		
		M SCR	950	2017		F		
		M XV	950	2014	2015	F		
		M XV ABS	950	2014	2016	F		
		M XV R ABS	950	2014	2017	F		
		M XV RACER ABS	950	2015	2017	F		
		M FZS FAZER	1000	2001	2005	F		
		M YZF R THUNDERACE	1000	1996	1998	F		
		M YZF R1	1000	1998	2001	F		
		M YZF R1	1000	2002	2003	F		
		M BT BULLDOG	1100	2002	2006	F		
		M XVZ VENTURE ROYALE	1200	1984	1987	F/R		

13012

FERODO
RACING
Updated on November 2020

M = MOTORCYCLE
S = SCOOTER
A = ATV
Sn = SNOWMOBILE



FRONT
/ REAR
CC FROM TO

Code	Brand	Model	CC	FROM	TO	FRONT / REAR		
...FMD0126		M FJR	1300	2001	2004	F		
		M FJR A	1300	2013	2015	F		
		M XJR	1300	1999	2015	F		
		M XJR	1300	2016	2017	F		
		M XJR RACER	1300	2016	2017	F		
		M XVS CU CUSTOM	1300	2014	2016	F		
		M XVS MIDNIGHT STAR	1300	2007	2016	F		
		M XV FC ROAD STAR WARRIOR	1700	2002	2007	F		
		M XV A CASUAL FULL DRESS	1900	2016		F		
		M XV A MIDNIGHT STAR	1900	2013	2016	F		
		FMD0128	HONDA	M CBR RR	900	1998	1999	F
				M CB X4	1300	1997	2000	F
FMD0129	YAMAHA	M YZF R7	750	1999	2001	F		
		M XVS A MIDNIGHT STAR	950	2009	2013	F		
		M FJR ABS	1300	2003	2017	F		
		M FJR AE	1300	2014	2017	F		
		M FJR AS	1300	2015	2017	F		
		M MT-01	1670	2005	2006	F		
FMD0130	HONDA	M CBR RR	929	2000	2001	F		
		M CBR RR	954	2002	2003	F		
FMD0132	APRILIA CAGIVA	M RS REPLICA	250	1998	2003	F		
		M RAPTOR	650	2001	2007	F		
		M RAPTOR	1000	2000	2006	F		
		M V-RAPTOR	1000	2000	2006	F		
		M XTRA-RAPTOR	1000	2002	2004	F		
FMD0133	KYMCO	S NEW DINK	200	2008		R		
		S GRAND DINK	250	2001	2002	R		
FMD0134	HONDA	M CBR F	600	2001	2007	F		
		M CBR F SPORT	600	2001	2002	F		
		M CB F HORNET	900	2002	2006	F		
FMD0135	HONDA	M CBR RR Fireblade	1000	2006	2007	F		
		M VTR SP1 RC51	1000	2000	2001	F		
		M VTR SP2 RC51	1000	2002	2004	F		
FMD0137	HONDA	M CB F HORNET	600	2000	2006	F		
		M CB F HORNET S	600	2000	2004	F		
FMD0139	YAMAHA	M MT03 ABS	320	2016	2018	F		
		M YZF R3	320	2015	2018	F		
		M FZ6	600	2004	2008	F		
		M FZ6 FAZER	600	2004	2007	F		
		M FZ6 FAZER	600	2008	2008	F		
		M FZ6 FAZER S2	600	2007	2009	F		
		M FZ6 S2	600	2007	2008	F		
		M XJ6	600	2009	2012	F		
		M XJ6 ABS	600	2013	2015	F		
		M XJ6 DIVERSION	600	2009	2015	F		
		M XJ6 DIVERSION ABS	600	2013	2015	F		
		M XJ6 DIVERSION F	600	2010	2012	F		
		M YZF R6	600	2003	2004	F		
		M MT-03	660	2006	2012	F		
		M TRACER 900 GT	847	2018	2019	F		
		M MT-09	850	2014	2019	F		
		M MT-09 ABS	850	2014	2019	F		
		M MT-09 SP ABS	850	2018	2019	F		
		M MT-09 SPORT TRACKER ABS	850	2016	2016	F		
		M MT-09 STREET RALLY ABS	850	2014	2016	F		
		M MT-09A TRACER	850	2015	2019	F		
		M XSR 900	850	2016	2019	F		
		M XSR 900 ABARTH ABS	850	2017	2019	F		
		M XSR 900 ABS	850	2016	2019	F		
		FMD0140	HONDA	M CBR RR	600	2003	2006	F
				M CBR RR	600	2007	2017	F
				M CB 1000 R	1000	2008	2016	F
				M CB 1000 R - ABS	1000	2009	2017	F
				M CBR RR Fireblade	1000	2004	2005	F
				M CB	1300	2003	2008	F
M CTX 1300 ABS	1300			2014	2016	F		
FMD0146	TRIUMPH	M DAYTONA T955i	955	2002	2006	F		
		M SPEED TRIPLE T955	955	2002	2005	F		
		M T955 DAYTONA	955	2002		F		
		M SPRINT ST T1050	1050	2005	2008	F		
		M ROCKET III CLASSIC	2300	2004	2015	F		
		M ROCKET III ROADSTER ABS	2300	2010	2017	F		
FMD0147	DUCATI	M 748 R	748	2001	2002	F		
		M 996 R	996	2001		F		
		M 996 SPS	996	1999	2000	F		
		M 998 R	998	2002	2003	F		
FMD0148	SUZUKI	M DR DJEBEL	650	1990	1990	F		
		M DR RS	650	1990	1991	F		

M = MOTORCYCLE
S = SCOOTER
A = ATV
Sn = SNOWMOBILE



FRONT
/ REAR
CC FROM TO

Code	Brand	Model	CC	FROM	TO	FRONT / REAR
FMD0151	SUZUKI	M DR BIG S	750	1987	1988	F
		M DR BIG S	800	1989	1990	F
FMD0155	YAMAHA	M RM	80	1990	2001	F
		M RM	85	2002	2004	F
FMD0156	YAMAHA	M SR	125	1997	2002	F
		M RD LC	350	1983	1993	F/R
		S T MAX ABS XP	500	2005	2007	R
		S T MAX ABS XP	500	2008	2011	R
		S T MAX SV ABS XP	500	2011	2011	R
		S T MAX SV XP	500	2011	2011	R
		S T MAX XP	500	2001	2003	R
		S T MAX XP	500	2004	2007	R
		S T MAX XP	500	2008	2011	R
		M XJ	600	1983	1991	F/R
		M XT	600	1987	1990	F
		M XT 4 VALVES	600	1986	1987	F
		M XT 4 VALVES	600	1988	1989	F
		M XT E	600	1990	1994	F
		M XT Z TENERE	600	1986	1986	F
		M XT Z TENERE	600	1987	1991	F
		M FZ GENESIS	750	1987	1988	R
		M FZ GENESIS	750	1989	1992	R
		M FZX FAZER	750	1986	1990	R
		M XV VIRAGO	750	1987	1993	F
		M XJ S DIVERSION	900	1994	1996	R
		M FZR EXUP	1000	1990	1995	R
		M FZR GENESIS	1000	1987	1989	R
		M FZS FAZER	1000	2001	2005	R
		M BT BULLDOG	1100	2002	2006	R
		M XJR	1200	1995	1996	R
		M XJR	1200	1997		R
		M XJR	1300	1998	1998	R
		M XJR	1300	1999	2015	R
		M MT-01	1670	2005	2006	R
M MT-01	1670	2007		R		
FMD0157	HRD YAMAHA	S YP SKYLINER	125	2001		R
		S YP SKYLINER	150	2001	2002	R
		S YP E SKYLINER	180	2003		R
		S MAJESTY YP E	125	2001	2009	R
		S MAJESTY YP	150	2001	2002	R
S MAJESTY YP E	180	2003	2006	R		
FMD0159	YAMAHA	M GS 97	250	1997		F
		M WR	125	1998	2000	F
		M YZ	125	1998	2001	F
		M WR	250	1992	1997	F
		M WR	250	1998	2000	F
		M YZ	250	1998	2000	F
		M WR F	400	1998	2000	F
		M YZ-F	400	1998	2000	F
		M WR F	426	2000	2000	F
		M YZ-F	426	2000	2000	F
FMD0160	YAMAHA	M TT	600	1993	1995	F
		M TT E	600	1993	2001	F
		M TT K	600	1993	1996	F
		M TT R	600	1998	2002	F
		M TT R E	600	2004	2007	F
FMD0163	YAMAHA	M XJ DIVERSION S-N	600	1991	1997	F
		M XJ N	600	1991	1997	F
		M XJ S DIVERSION	600	1991	1997	F
FMD0163	YAMAHA	M XVZ TF ROYAL STAR VENTURE	1300	1996	2007	R
		M XVZ13TF WILD STAR	1300	1999		R
		M TDR (Japanese model)	125	1989		F
		M XV VIRAGO	125	1997	2000	F
		M XV VIRAGO (Rear Drum Model)	125	1997	2001	F
		M XVS DRAG STAR	125	1999	2001	F
		M XVS DRAG STAR (Rear Drum Model)	125	1999	2004	F
		M XVS VIRAGO	125	1998	2000	F
		M SRV (Rear Drum Model)	250	1992	1997	F
		M SRV S -RENAISSA	250	1992	2000	F
		M XV VIRAGO	250	1995	2007	F
		M XVS DRAG STAR	250	2001		F
M XVS DRAG STAR (Rear Drum Model)	250	2001	2004	F		
FMD0163	YAMAHA	S T MAX XP	500	2001	2003	F
		M GTS / GTS A	1000	1993	1999	R
		M FJ	1100	1984	1987	F/R
		M XVS DRAG STAR	1100	1999	2006	R
		M FJ	1200	1986	1987	F/R
		M FJ	1200	1988	1991	R



CC FROM TO FRONT / REAR

Code	Brand	Model	CC	From	To	Front / Rear		
...FMD0163		M FJ	1200	1992	1995	R		
		M FJ ABS	1200	1991	1991	R		
		M FJ ABS	1200	1992	1993	R		
		M V MAX	1200	1986	1992	F/R		
		M V MAX	1200	1993	2006	R		
		M FJR	1300	2001	2004	R		
		M FJR A	1300	2013	2015	R		
		M FJR ABS	1300	2003	2017	R		
		M FJR AE	1300	2014	2017	R		
		M FJR AS	1300	2015	2017	R		
		M XVZ 13 T-TD VENTURE ROYALE	1300	1988	1995	F		
		FMD0164	APRILIA	M MX	125	2004	2007	R
				M PEGASO	125	1990	1991	R
M RS EXTREMA	125			1992	1997	R		
M RS REPLICA	125			1992	1997	R		
M PEGASO	600			1989	1990	R		
M MOTO 6.5	650			1995	2002	R		
M PEGASO	650			1991	2000	R		
VOR	M EN			400	2000	2002	R	
	M SMR C			400	2000	2002	R	
	M EN			450	2002		R	
	M SMC			450	2002		R	
	M SMR C			450	2002		R	
	M EN		492	1998	2001	R		
	M EN		495	1998	2001	R		
	M MSM		495	1998	2001	R		
	M Cross		500	1998	2002	R		
M Enduro	500		1998	2002	R			
M SM	500		1999		R			
M MX EX	503		2000	2002	R			
M EN	530		2002		R			
M MSME	530		2002		R			
M SMR C	530	2002		R				
FMD0165	GILERA	S GSM	50	1999		F		
		S H@C	50	1999		F		
		S SURFER	50	1999		F		
		S ZULU	50	2001		F		
		S SNIPER DD	50	1994	1996	R		
FMD0166	KYMCO	S SNIPER DD	50	1994	1996	R		
FMD0167	GILERA	S GSM	50	1999		R		
		S H@C	50	1999		R		
		S ZULU	50	2001		R		
FMD0168	PIAGGIO	S X8 (pinza HengTong)	200	2005		F		
		M BEVERLY EURO 3	400	2006	2008	F		
		M X9 EVOLUTION	500	2003	2004	F		
		S X9 EVOLUTION ABS	500	2006	2007	F		
		S RS	50	1999	2005	R		
FMD0170	APRILIA	S RS REPLICA	50	2000	2005	R		
		M TUONO	50	2003	2004	R		
		M TUONO	50	2005		R		
		M RS	125	1996	2011	R		
		S SCARABEO i.e. LIGHT	125	2008	2009	R		
		S SCARABEO LIGHT	125	2007	2008	R		
		M TUONO	125	2003	2004	R		
		S SCARABEO	200	2007	2010	R		
		S SCARABEO LIGHT	250	2006	2008	R		
		BMW	S C 1	125	1999		F/R	
			S C 1	200	2001		F/R	
			S XQ THUNDER	125	2001		R	
	MBK	S MAXSTER XQ	125	2001	2002	R		
		S MAXSTER XQ	150	2001	2002	R		
	FMD0171	APRILIA	S LEONARDO	250	1999	2001	R	
			S LEONARDO ST	250	2001	2004	R	
			S LEONARDO	300	2002	2004	R	
			S ATLANTIC SPRINT	400	2005	2008	R	
			S ATLANTIC	500	2002	2004	R	
			S ATLANTIC SPRINT	500	2005	2008	R	
			S SCARABEO	500	2002	2006	R	
FMD0172			DERBI	M FENIX	50	1995	1998	R
	M SENDA EX	50		1995	1997	R		
	M SENDA L	50		1999		R		
	M SENDA R	50		1997	1997	R		
	M SENDA R	50		1998	1999	R		
	M SENDA R RACER	50		2002		R		
	M SENDA R XTREAM	50		2000	2001	R		
	M SENDA SM RACER	50		2002		R		
	M SENDA SM XTREAM	50		2000	2001	R		
	M SENDA SR	50		1999	2000	R		
	M SENDA SR	50		2001		R		



CC FROM TO FRONT / REAR

Code	Brand	Model	CC	From	To	Front / Rear		
FMD0173	ITALJET	M SENDA SUPERMOTARD	50	1997	1999	R		
		S JUPITER	125	2002		R		
		S JUPITER	150	2002		R		
		S JUPITER	250	2000	2003	R		
		M YP SKYLINER	250	2000	2003	R		
FMD0175	YAMAHA	S MAJESTY ABS YP	250	2003		R		
		S MAJESTY YP	250	2000	2003	R		
		S YP 250 MAJESTY	250	2001		R		
		M TZR	50	1996	2002	F		
		M TZR	80	1996	1998	F		
FMD0176	YAMAHA	M TZR	125	1987	1995	F		
		M TZR R	125	1991	1995	F		
		M TZR RED ROCKET	125	1993	1995	F		
		M XT E	600	1995	1996	F		
		M XTZ TENERE	660	1991	1991	F		
		M XV VIRAGO	750	1994	2000	F		
		FMD0177	TRIUMPH	M (TRIDENT) SPRINT 749 Up to 9082	749	1993		R
				M TRIDENT	749	1991	1998	R
				M DAYTONA	750	1991	1992	R
				M SPEED TRIPLE (carb)	885	1994	1996	R
M DAYTONA 885	900			1993	1996	R		
M DAYTONA 900 SUPER 3 750	900			1994	1996	R		
M SPRINT 885	900			1994	1997	R		
M SPRINT EXECUTIVE 885	900			1998	1998	R		
M SPRINT SPORT 885	900			1997	1998	R		
M TRIDENT 885	900			1991	1998	R		
M TROPHY 885	900			1991	2001	R		
M DAYTONA 998	1000			1991	1992	R		
M DAYTONA 1180	1200			1993	1997	R		
M TROPHY 1180	1200	1991	2003	R				
FMD0179	HUSQVARNA	M CR	125	1991	1996	R		
		M WR	125	1991	1997	R		
		M WR	250	1991	1997	R		
		M TE	350	1990	1995	R		
		M TE	350	1996	2013	R		
		M TE	410	1995	2000	R		
		M TC	610	1991	1997	R		
FMD0180	DUCATI	M TE	610	1991	1997	R		
		M 748	748	2002		R		
		M 748 BIPOSTO	748	1995	2002	R		
		M 748 BIPOSTO	748	2003		R		
		M 748 BIPOSTO - SP	748	1995	2001	R		
		M 748 R	748	2000	2000	R		
		M 748 R	748	2001	2002	R		
		M 748 S	748	1999	2002	R		
		M 748 SP	748	1995	1997	R		
		M 748 SPS	748	1998	1999	R		
		M MH	900	2001	2002	R		
		M 916 BIPOSTO	916	1994	1998	R		
		M 916 BIPOSTO SENNA	916	1994	1998	R		
		M 916 SP	916	1994	1996	R		
		M 916 SPS	916	1997	1998	R		
M 916 RACING	926	1994	1997	R				
M 996 BIPOSTO	996	1999	2001	R				
M 996 R	996	2001		R				
M 996 S	996	2001		R				
M 996 SPS	996	1999	2000	R				
M 998 BIPOSTO	998	2002	2003	R				
M 998 R	998	2002	2003	R				
M 998 S (four pads)	998	2002	2003	R				
M 998 S (two pads)	998	2002	2003	R				
FMD0182	YAMAHA	M GS- MC	125	1990	1992	R		
		M MX EX	503	2000	2002	F		
		M DT R	125	1988	2003	R		
		M TDR	125	1989	2001	R		
		M WR	125	1989	1990	R		
		M WR	125	1991	1997	R		
		M YZ	125	1985	1989	R		
		M YZ	125	1990	1997	R		
		M WR R	200	1992	1995	R		
		M TT R	250	1993		R		
M WR	250	1990	1991	R				
M WR	250	1992	1997	R				
M YZ	250	1985	1990	R				
M YZ	250	1990	1997	R				
M YZ	360	1989		R				
M YZ RALLY	360	1990	1993	R				
M WR F	400	1998	2000	R				



CC FROM TO FRONT / REAR

...	CC	FROM	TO	FRONT / REAR
...FMD0182		M	WR Z	500	1992	1993 R
		M	TT	600	1993	1995 R
		M	TT	600	1996	2001 R
		M	TT R	600	1998	2002 R
		M	TT R	600	2003	2007 R
FMD0184	CCM	M	DS	644	2002	2006 R
		M	R30	644	2002	2006 R
	GAS GAS	M	EC	125	1996	2011 R
		M	EC RACING	125	2013	2014 R
		M	EC- MC	125	1996	R
		M	MC	125	1996	2009 R
		M	EC	200	2000	2014 R
		M	HOBBY	200	2007	R
		M	EC	250	1996	2010 R
		M	EC 2T	250	2011	2014 R
		M	EC 4T	250	2011	2014 R
		M	EC F RACING	250	2013	2014 R
		M	EC RACING	250	2012	2013 R
		M	EC- MC	250	1996	R
		M	MC	250	1996	2009 R
		M	EC	300	1996	2012 R
		M	EC 2T	300	2013	2014 R
		M	EC F RACING	300	2013	2014 R
		M	EC RACING	300	2012	2013 R
		M	EC- MC	300	1996	R
		M	MC	300	1996	2009 R
		M	EC	400	2002	2002 R
		M	EC	400	2006	2007 R
		M	FSE	400	2002	R
		M	MC	400	2002	2002 R
		M	MC	400	2006	2007 R
		M	PAMPERA	400	2006	2007 R
		M	EC	450	2003	2007 R
		M	EC F	450	2013	2014 R
		M	FSE	450	2003	2006 R
		M	FSR	450	2007	R
		M	MC	450	2003	2003 R
		M	MC	450	2007	2007 R
	HUSABERG	M	TE	125	2012	2014 R
		M	FE	250	2013	2014 R
		M	TE	250	2011	2014 R
		M	TE	300	2011	2014 R
		M	FE	350	2013	2014 R
		M	FE	390	2010	2010 R
		M	FE	390	2011	2012 R
		M	FE	400	2000	2003 R
		M	FE E	400	2001	2003 R
		M	FS C	400	2001	2003 R
		M	FS E	400	2001	2003 R
		M	FE	450	2009	2012 R
		M	FE	450	2013	2014 R
		M	FS C	450	2003	2008 R
		M	FS E	450	2003	2008 R
		M	FS E- C	450	2003	2004 R
		M	FS E- C	450	2005	2006 R
		M	FX	450	2010	R
		M	FC	501	1999	2003 R
		M	FE E	501	1999	2004 R
		M	FE S	501	1999	2004 R
		M	FE	510	2013	2014 R
		M	FC	550	2001	2005 R
		M	FE E	550	2004	2008 R
		M	FE	570	2010	2012 R
		M	FS	570	2010	R
		M	FC	600	1999	2003 R
		M	FE E	600	1999	2002 R
		M	FE S	600	1999	2003 R
		M	FE E	650	2001	2008 R
		M	FS C	650	2001	2008 R
		M	FS E	650	2001	2008 R
		M	FS E- C	650	2001	2004 R
		M	FS E- C	650	2005	2006 R
		M	FX E	650	2001	2005 R
	HUSQVARNA	M	TC	125	2014	R
		M	TE	125	2014	2015 R
		M	FC	250	2014	2016 R
		M	FE	250	2014	2015 R
		M	TC	250	2014	R



CC FROM TO FRONT / REAR

...	CC	FROM	TO	FRONT / REAR
		M	TE	250	2014	2016 R
		M	TE	300	2014	2015 R
		M	FC	350	2014	2016 R
		M	FE	350	2014	2015 R
		M	FC	450	2014	2016 R
		M	FE	450	2014	2015 R
		M	FE	501	2014	2015 R
		M	FE	510	2014	R
	KTM	M	EXC	125	1998	2014 R
		M	EXC	125	2015	R
		M	EXC SIX DAYS	125	2009	2014 R
		M	EXC SIX DAYS	125	2015	R
		M	GS	125	1988	1992 R
		M	GS	125	1993	1997 R
		M	MX	125	1988	1991 R
		M	MX	125	1992	2000 R
		M	STING	125	1998	R
		M	SX	125	1993	2014 R
		M	SX	125	2015	R
		M	SXS	125	2000	2010 R
		M	SX	144	2007	2010 R
		M	SX	150	2008	2014 R
		M	SX	150	2015	R
		M	XC	150	2010	2016 R
		M	EXC	200	1998	2014 R
		M	EXC	200	2015	R
		M	MXC	200	1998	2003 R
		M	SX	200	2003	2007 R
		M	SX	200	2008	R
		M	XC W	200	2008	2016 R
		M	EXC	250	1998	2014 R
		M	EXC	250	2015	R
		M	EXC F	250	2003	2006 R
		M	EXC F	250	2007	2014 R
		M	EXC F	250	2015	R
		M	EXC F SIX DAYS	250	2009	2014 R
		M	EXC F SIX DAYS	250	2015	R
		M	EXC G	250	2004	2009 R
		M	EXC SIX DAYS	250	2009	2014 R
		M	EXC SIX DAYS	250	2015	R
		M	GS	250	1988	1992 R
		M	GS	250	1993	1997 R
		M	MX	250	1988	1991 R
		M	MX	250	1992	2013 R
		M	MXC	250	1998	2003 R
		M	SX	250	1993	2014 R
		M	SX	250	2015	R
		M	SX F	250	2001	2004 R
		M	SX F	250	2005	2014 R
		M	SX F	250	2015	R
		M	SXS	250	2003	2003 R
		M	SXS	250	2004	2010 R
		M	SXS F	250	2006	2009 R
		M	XC	250	2008	2016 R
		M	XC W	250	2006	2010 R
		M	XC W	250	2011	2012 R
		M	XC W	250	2013	R
		M	XCF W	250	2012	2013 R
		M	XCF W	250	2014	R
		M	EXC	300	1997	2013 R
		M	EXC	300	1997	2002 R
		M	EXC	300	2014	R
		M	EXC SIX DAYS (2T)	300	2009	2013 R
		M	EXC SIX DAYS (2T)	300	2014	2015 R
		M	GS	300	1991	1996 R
		M	MX	300	1991	1992 R
		M	MXC	300	1998	2005 R
		M	SX	300	1993	2000 R
		M	SX	300	2001	2003 R
		M	XC (2T)	300	2006	2010 R
		M	XC (2T)	300	2011	2012 R
		M	XC W	300	2006	2012 R
		M	EXC F	350	2010	2011 R
		M	EXC F	350	2012	2014 R
		M	EXC F	350	2015	R
		M	EXC F SIX DAYS	350	2011	2011 R
		M	EXC F SIX DAYS	350	2012	2013 R
		M	EXC F SIX DAYS	350	2014	R

M = MOTORCYCLE
S = SCOOTER
A = ATV
Sn = SNOWMOBILE



FRONT
/ REAR

...FMD0184

	CC	FROM	TO	FRONT / REAR
M GS	350	1993	2000	R
M SX-F	350	2011	2017	R
M EXC	380	1998	2002	R
M MXC	380	1998	2001	R
M SX	380	1998	2002	R
M EGS	400	1996	1999	R
M EXC	400	1994	2005	R
M EXC	400	2006	2011	R
M EXC G	400	2004	2006	R
M SX	400	2000	2002	R
M XC W	400	2007	2009	R
M EXC	450	2003	2007	R
M EXC	450	2008	2014	R
M EXC	450	2015		R
M EXC R	450	2008	2009	R
M EXC SIX DAYS	450	2009	2015	R
M MXC	450	2003	2006	R
M SMR	450	2004	2013	R
M SMR	450	2014		R
M SX F	450	2015		R
M SX-F	450	2003	2014	R
M SXS	450	2003	2010	R
M SXS F	450	2003	2010	R
M XC	450	2007	2007	R
M XC	450	2008	2009	R
M XC F	450	2007	2009	R
M XC G	450	2006		R
M XC W	450	2007	2007	R
M XC W	450	2008	2009	R
M EXC	500	2011	2011	R
M EXC	500	2012	2013	R
M EXC	500	2014		R
M EXC SIX DAYS	500	2011	2015	R
M MX	500	1989	1991	R
M MX	500	1992	1992	R
M SX	500	1993	1995	R
M SX F	505	2007	2009	R
M XC F	505	2007	2009	R
M EXC	520	2000	2002	R
M MXC	520	2001	2002	R
M SX	520	2000	2002	R
M EXC	525	2003	2007	R
M EXC	525	2008	2008	R
M MXC	525	2003	2005	R
M SMR	525	2004	2005	R
M SX	525	2003	2006	R
M XC	525	2006	2007	R
M XC	525	2008	2008	R
M XC DESERT RACING	525	2006	2007	R
M XC G	525	2006	2008	R
M XC W	525	2006	2008	R
M EXC	530	2010	2011	R
M EXC R	530	2008	2009	R
M EXC SIX DAYS	530	2009		R
M SXC	540	1999	2000	R
M SXS	540	2001	2006	R
M SMR	560	2006	2008	R
M GS	600	1993	2000	R
M LC4	600	1991	1992	R
M MX	600	1990	1992	R
M DUKE	620	1995	1998	R
M EGS-LC4	620	1996	2002	R
M LC4 ADVENTURE	620	1997	1998	R
M LC4 SC SUPERCOMP	620	1998	2001	R
M LC4 SC SUPERCOMP	620	2002	2004	R
M LC4 SUPERMOTO	620	1999	2001	R
M LC4 SC SUPERCOMP	625	2002		R
M LC4 SUPERMOTO	625	2002	2004	R
M SMC	625	2005	2007	R
M SMC	625	2008		R
M SXC	625	2003	2007	R
M SXC	625	2008		R
M DUKE II	640	1999	2002	R
M LC4 ADVENTURE	640	1998	2000	R
M LC4 ADVENTURE	640	2001	2003	R
M LC4 ADVENTURE	640	2004	2007	R
M LC4 ENDURO	640	1999	2007	R
M LC4 SUPERMOTO	640	1998	1999	R



FRONT
/ REAR

	CC	FROM	TO	FRONT / REAR	
M LC4 SUPERMOTO	640	2000	2007	R	
M SMC	660	2003	2007	R	
FMD0185 HONDA	M CR R	125	1985	1988 R	
	M CR R	500	1987	1989 R	
FMD0186 SUZUKI	M RM	125	1988	2000 R	
	M RM	250	1989	2000 R	
	M RMX	250	1989	1999 R	
	M DR Z E	400	2000	2017 R	
	M DR Z S	400	2000	2017 R	
FMD0187 SUZUKI	M DR DJEBEL	600	1989		R
	M DR DJEBEL	650	1990	1990 R	
	M DR DJEBEL	650	1991	1995 R	
	M DR R	650	1990	1993 R	
	M DR RE	650	1994	1995 R	
	M DR RS	650	1990	1991 R	
	M DR RSE	650	1991	1993 R	
	M DR BIG	750	1988	1989 R	
	M DR BIG S	800	1989	1990 R	
	M DR BIG S	800	1991	1996 R	
FMD0190 HUSQVARNA	M CR	125	1996	2003 R	
	M WR	125	1998	2003 R	
	M WRE	125	1995	2004 R	
	M WRE DUAL	125	1995	2003 R	
	M CR	250	1996	2003 R	
	M TE	250	2002	2003 R	
	M WR	250	1998	2003 R	
	M WR	360	2000	2001 R	
	M TE	410	2000	2001 R	
	M TE E	610	2000	2003 R	
FMD0197 HONDA	M CR R - E	125	2002	2007 R	
	M CR R - E	250	2002	2010 R	
	M CRE IE	250	2007	2008 R	
	M CRE- F - X	250	2007		R
	M CRF R	250	2004	2014 R	
	M CRF R	250	2015		R
	M CRF R EFI	250	2010		R
	M CRF R - X	250	2004	2007 R	
	M CRF R - X SUPERMOTARD	250	2004	2007 R	
	M CRF X	250	2004		R
	M CRE IE	290	2007	2008 R	
	M CRF X	300	2008	2012 R	
	M CRF 450 L	450	2019		R
	M CRF EFI	450	2009	2012 R	
	M CRF R	450	2002	2014 R	
	M CRF R	450	2015		R
	M CRF R EFI	450	2013	2014 R	
	M CRF RX	450	2017		R
	M CRF RX Enduro	450	2017		R
	M CRF SUPERMOTARD	450	2002	2003 R	
	M CRF X	450	2004	2007 R	
	M CRM X SUPERMOTARD	450	2007		R
	M CR R	500	2002		R
	M CRM X SUPERMOTARD	500	2007		R
FMD0199 KAWASAKI	M ZX7R NINJA	750	1989	1995 R	
	M ZX7R NINJA	750	1996	2003 R	
	M ZX7RR NINJA	750	1996	2002 R	
	M ZXR	750	1989	1995 R	
	M ZXR L	750	1993	1995 R	
	M ZXR R	750	1989	1992 R	
	M ZXR R	750	1993	1995 R	
	M ZX-9 R NINJA	900	1994	1997 R	
	M ZX9R NINJA	900	1994	1997 R	
	M GTR	1000	1986	1993 R	
	M ZEPHYR	1100	1996	1998 R	
	M ZR ZEPHYR	1100	1996	1997 R	
FMD0203 HONDA	S SILVER WING FJS	400	2006	2008 R	
	S SW-T	400	2009	2014 R	
	S SW-T ABS	400	2009	2014 R	
	M SILVER WING	600	2007	2007 R	
	S SILVER WING ABS	600	2003	2007 R	
	S SILVER WING ABS	600	2008	2008 R	
	S SILVER WING FSC	600	2001	2006 R	
	S SW-T	600	2009	2015 R	
FMD0206 BMW	M R 850 R	850	1994	2003 F	
	M R 850 RT	850	1995	2001 F	
	M K 100 RS 16V	1000	1989	1993 F	
	M K1	1000	1989	1993 F	
	M K 1100 LT	1100	1992	2000 F	

13016

FERODO

RACING

Updated on November 2020

M = MOTORCYCLE
S = SCOOTER
A = ATV
Sn = SNOWMOBILE



CC FROM TO FRONT / REAR

Code	Brand	Model	CC	FROM	TO	FRONT / REAR		
...FMD0206		M K 1100 RS	1100	1993	1996	F		
		M R 1100 R	1100	1995	2001	F		
		M R 1100 RS	1100	1994	2001	F		
		M R 1100 RT	1100	1994	2001	F		
		M R 1100 RT ABS	1100	1994	2001	F		
FMD0207	APRILIA	M PEGASO FACTORY	650	2007	2009	R		
		M PEGASO I.E.	650	2001	2004	R		
		M PEGASO TRAIL	650	2005	2008	R		
	BENELLI	M BN 302	300	2015	2016	R		
		M BN 600	600	2015	2017	R		
		M BN 600 GT	600	2015	2017	R		
		M CENTURY RACER	899	2011	2015	R		
		M TNT	899	2008	2016	R		
		M TNT S	899	2008	2011	R		
		M TRE K	899	2011	2016	R		
		M TNT	1100	2004		R		
		M CAFE RACER	1130	2006	2015	R		
		M CENTURY RACER	1130	2011	2014	R		
		M TITANIUM	1130	2005	2007	R		
	BMW	M TNT	1130	2004	2006	R		
		M TNT R160	1130	2011		R		
		M TNT RS	1130	2005	2007	R		
		M TORNADO NAKED TRE R	1130	2016		R		
		M TRE K	1130	2007	2017	R		
		M F 650	650	1994	2001	R		
		M F 650 CS	650	2002	2007	R		
M F 650 GS		650	2001	2007	R			
M F 650 GS ABS		650	2001	2007	R			
M F 650 GS DAKAR		650	1999	2007	R			
M F 650 ST		650	1997	2001	R			
HUSQVARNA	M G 650 GS	650	2009	2016	R			
	M G 650 GS SERTAO	650	2012	2014	R			
	M TR 650 STRADA	650	2013	2014	R			
FMD0210	GILERA	M TR 650 TERRA	650	2013	2014	R		
		S RUNNER DD - SP	50	1997	2004	R		
		S RUNNER PURE JET	50	2002	2006	R		
		S RUNNER PURE JET ST	50	2008		R		
		S RUNNER SP	50	1998	2006	R		
	PIAGGIO	S RUNNER SP RACE	50	2006		R		
		S RUNNER SP SC	50	2006	2007	R		
		S RUNNER SP ST	50	2008		R		
		S STALKER (post freno a disco)	50	1997	2004	R		
		S NRG EXTREME	50	1999	2000	R		
		S NRG MC3	50	2001	2004	R		
		S ZIP 4T (grimeca/heng tong caliper)	50	2000	2010	F		
		S ZIP CAT DT 2T	50	2001	2005	F		
		FMD0211	HARLEY D.	M XLH 883 SPORTSTER	883	1970	1984	R
M XLH 883 SPORTSTER	883			1985	1999	R		
M XL 1000	1000			1978		R		
M XLS 1000 ROADSTER	1000			1979	1984	R		
M XLH 1200 SPORTSTER	1200			1987	1999	R		
M XLH 1200 SPORTSTER SPORT	1200			1996	1999	R		
M FLH 1340 80	1340			1981	1984	R		
M FLH 1340 81	1340			1987	1999	R		
M FLH 1340 82	1340			1987	1999	R		
M FLH 1340 83	1340			1989	1999	R		
M FLH 1340 ELECTRA GLIDE	1340			1982	1983	R		
M FLSTC 1340 HERITAGE SOFTAIL CLASSIC	1340			1989	1999	R		
M FLSTC FAT BOY	1340			1989	1999	R		
M FLSTC HERITAGE SOFTAIL CLASSIC	1340			1989	1999	R		
M FLSTF FAT BOY	1340			1989	1999	R		
M FXDWG DYNA WIDE GLIDE	1340			1993	1998	R		
M FXLR 1340 LOW RIDER CUSTOM	1340			1987	1999	R		
M FXR 1340 SUPER GLIDE	1340			1982	1999	R		
M FXRS 1340 LOW RIDER SPORT	1340			1987	1999	R		
M FXRT 1340 SPORT GLIDE	1340			1987	1999	R		
M FXSTC SOFTAIL CUSTOM	1340			1989	1993	R		
M FXSTC SOFTAIL CUSTOM	1340			1996	1999	R		
M FXSTS 1340 SPRINGER SOFTAIL	1340			1989	1999	R		
M FLHR/I ROAD KING	1450			1998	1999	R		
M FLHT/I ELECTRA GLIDE STANDARD	1450			1998	1999	R		
M FLTR/I ROAD GLIDE	1450			1998	1999	R		
M FXDS DYNA SUPER GLIDE SPORT	1450			1998	1999	R		
M FXDWG DYNA WIDE GLIDE	1450			1993	1999	R		
M FXRS SPORT GLIDE	1450			1984	1986	R		
FMD0212	HONDA			M CR R	125	1989	1994	R
				M CR R - E	125	1995	2001	R
		M AX 1	250	1989	1994	R		



CC FROM TO FRONT / REAR

Code	Brand	Model	CC	FROM	TO	FRONT / REAR
		M CR R	250	1989	1994	R
		M CR R - E	250	1995	1996	R
		M CR R	500	1990	1994	R
		M CR R	500	1995	2001	R
FMD0214	HONDA	M CR R	80	1997	2002	R
		M CR	85	2003	2007	R
		M CRF R	150	2007	2016	R
FMD0216	HONDA	M XR R	650	2000	2007	R
FMD0217	HONDA	M NSR 50	50	1996	2001	R
		S SH 50 SCOOPY	50	1997	2003	F
		M NSR 75 (NS-1)	75	1994	1998	R
		S SH 100 SCOOPY	100	1996	2001	F
		M CBR R HURRICANE	400	1986		R
		M NSR R	400	1985	1988	R
		M VFR R	400	1985	1986	R
		M VFR R	400	1987	1987	R
		M VFR R	400	1988	1988	R
		M CBR F	600	1987	1990	R
		S YH 50 WHY	50	1999	2007	F
FMD0218	KAWASAKI	M ELIMINATOR	400	1988	1989	F
		M ER5	500	1996	2006	F
		M GPZ S	500	1987	1988	F
		M ELIMINATOR	600	1986	1994	F
		M Z 750TURBO	750	1984	1986	F
		M ELIMINATOR	900	1985	1987	F
		M GPZ NINJA	900	1984	1986	F
		M GPZ R	900	1984	1989	F
		M ELIMINATOR	1000	1986	1990	F
		M GPX R	1000	1986	1989	F
		M GTR	1000	1994	2006	R
FMD0220	HONDA	M ZL	1000	1986	1988	F
		M VFR F	750	1990	1993	R
		M VFR F	750	1994	1997	R
		M VFR FI	800	1998	1999	R
FMD0221	HONDA	M VFR V-TEC	800	1998	2001	R
		M VFR V-TEC	800	2002	2010	R
		M CR SUPERMOTARD	125	2000		R
FMD0222	HONDA	M CR R - E	250	1997	2001	R
		M CR SUPERMOTARD	250	1998	2001	R
FMD0224	KAWASAKI	M ZX-9 R NINJA	900	1998	1999	F
FMD0225	HUSQVARNA	M CR	125	1991	1996	F
		M WR	250	1991	1997	F
		M TE	350	1996	2013	F
		M TE	410	1995	2000	F
		M TE	610	1991	1997	F
FMD0227	KAWASAKI	M KX	80	1993	2000	R
		M KX	85	2001	2015	R
		M KX	100	2001	2014	R
		M RM	80	1990	2001	R
FMD0228	SUZUKI	M RM	85	2002	2004	R
		M SX	65	1998	2018	R
FMD0229	KTM	M SXS	65	2012	2013	R
		M XC	65	2008	2009	R
		M MX	80	2000	2002	R
		S PEOPLE EURO 2	125	2003	2004	F
FMD0229	PEUGEOT	S PEOPLE EURO 3	125	2007		F
		S ELYSEO	100	2002		F
		S ELYSEO (A.J.P.)	100	1998	2001	F
		S ELYSEO	125	1998	1998	F
		S ELYSEO	125	1999	1999	F
		S ELYSEO	125	2000		F
		S ELYSEO	150	2000		F
FMD0233	KAWASAKI	M ZXR	400	1989	1990	R
		M ZXR	400	1991	2002	R
		M ZXR (ZX 400L) RR	400	1992	2002	R
		M ZXR R	400	1991	1994	R
		M ZEPHYR	550	1993	2001	R
		M ZZR	600	1993	2005	R
		M ZZR (ZX E6F)	600	2006	2007	R
		M GPX	750	1987	1989	R
		M GPX R	750	1986	1987	R
		M ZR7	750	1999	2003	R
FMD0234	KAWASAKI	M ZR7S	750	2001	2003	R
		M KMX	125	1988	1995	R
		M KLE	500	1991	2007	R
		M KL TENGAI	650	1989	1992	R
		M KLR	650	1987	1994	R
		M KLR	650	1995	2004	R

M = MOTORCYCLE
S = SCOOTER
A = ATV
Sn = SNOWMOBILE



CC FROM TO FRONT / REAR

Code	Brand	Model	CC	FROM	TO	FRONT / REAR	
...FMD0234		M KLR	650	2005	2007	R	
		M KLR A	650	1987	1989	R	
		M KLR B1-B3 Tengai	650	1989	1991	R	
FMD0237	KAWASAKI	M ZX6R NINJA	600	1998	2001	R	
		M ZX6R NINJA	600	2007	2016	R	
		M ZX6RR NINJA	600	2003	2004	R	
		M ZX6RR NINJA	600	2005	2006	R	
		M ZX6R NINJA	636	2002	2002	R	
		M ZX6R NINJA	636	2003	2004	R	
		M ZX6R NINJA	636	2005	2006	R	
		M ER6F (No ABS)	650	2006	2015	R	
		M ER6N NO ABS	650	2006	2015	R	
		M VERSYS (NO ABS)	650	2007	2014	R	
		M Z 750	750	2004	2006	R	
		M Z 750 S	750	2005	2006	R	
		M ZX9R NINJA	900	1998	1999	R	
		M ZX9R NINJA	900	2000	2001	R	
		M ZX9R NINJA	900	2002	2003	R	
		M Z 1000	1000	2003	2006	R	
		M ZX-10R	1000	2004	2007	R	
		M ZX-10R	1000	2008	2010	R	
FMD0238	KAWASAKI	M ZX12R NINJA	1200	2000	2003	R	
		M ZX12R NINJA	1200	2004	2006	R	
FMD0239	KAWASAKI	M KX	125	2003	2005	R	
		M KX	125	2006	2008	R	
		M KX	250	2003	2006	R	
		M KX	250	2006	2008	R	
		M KX F	250	2004	2005	R	
		M KX F	250	2006	2014	R	
		M KX F	250	2015		R	
		M KLX R	450	2008	2015	R	
		M KX F	450	2006	2014	R	
		M KX F	450	2015	2018	R	
		M RMZ	250	2004	2006	R	
FMD0241	SUZUKI	M GSX R	600	2004	2005	F	
		M GSX R (Rad.cal)	600	2004	2005	F	
		M GSX R	750	2004	2005	F	
		M GSX R (Rad.cal)	750	2004	2005	F	
		M GSX R	1000	2003	2004	F	
FMD0242	SUZUKI	M DR S	250	1990		R	
		M DR R	350	1994	1999	R	
		M DR S	350	1989	1993	R	
		M DR S	350	1996	1999	R	
		M DR S-R	350	1989	1999	R	
FMD0244	KAWASAKI	S J125 ABS	125	2016	2019	R	
		S J300	300	2014	2015	R	
		S J300 ABS	300	2014	2017	R	
		S J300 ABS SPECIAL EDITION	300	2014	2017	R	
		S J300 SPECIAL EDITION	300	2014	2015	R	
		KYMCO	S AGILITY i R16 PLUS	125	2016	2017	R
			S AGILITY R16	125	2008	2017	R
			S AGILITY R16 PLUS	125	2014	2017	R
			S DOWNTOWN i	125	2009	2015	R
			S DOWNTOWN i E4	125	2016	2018	R
	S DOWNTOWN NOODOE i ABS		125	2019		R	
	S G DINK		125	2012	2016	F	
	S G DINK		125	2017		F	
	M K-XCT		125	2012	2016	R	
	M K-XCT		125	2017		R	
	S SUPER DINK		125	2009	2013	R	
	S X-TOWN i ABS/CBS		125	2015	2019	R	
	S AGILITY i R16		150	2008	2017	R	
	S AGILITY i R16 PLUS		150	2014	2017	R	
	S AGILITY R16		200	2009	2016	R	
	S AGILITY R16i PLUS		200	2014	2017	R	
	S DOWNTOWN i		200	2010	2017	R	
	S AGILITY maxi 300i ABS		300	2015		R	
	S DOWNTOWN i		300	2009	2015	R	
	S DOWNTOWN i ABS		300	2016	2018	R	
	S G DINK		300	2012	2016	F	
	S G DINK		300	2017		F	
	M K-XCT i		300	2013	2017	R	
	S SUPER DINK		300	2009	2012	R	
	S X-TOWN ABS		300	2016	2017	R	
	S X-TOWN ABS		300	2018		R	
	S DOWNTOWN i ABS		350	2015	2015	R	
	S DOWNTOWN i ABS E4	350	2016	2019	R		
	S DOWNTOWN i TCS NOODOE	350	2018	2019	R		



CC FROM TO FRONT / REAR

Code	Brand	Model	CC	FROM	TO	FRONT / REAR
FMD0246	SUZUKI	M GSF BANDIT	600	1995	1999	R
		M GSF BANDIT	600	2000	2004	R
		M GSX F	600	1998	2003	R
		M GSX F	600	2004	2006	R
		M RF R	600	1993	1997	R
		M GSF BANDIT	650	2005	2006	R
		M GSF BANDIT S	650	2005	2006	R
		M SV	650	1999	2002	R
		M SV S	650	1999	2002	R
		M GSX	750	1997	2003	R
		M GSX F	750	1998	2003	R
		M GSX F	750	2004	2006	R
		M GSX R	750	1985	1988	R
		M GSX R	750	1989	1995	R
		M GSX R W	750	1994	1995	R
		M RF	900	1994	1997	R
		M GSX R	1100	1989	2000	R
M GSF BANDIT	1200	1996	2005	R		
M GSX INAZUMA	1200	1999	2002	R		
M GSX R HAYABUSA	1300	1999	2007	R		
FMD0247	SUZUKI	M GS	400	1989	1989	R
		M GSF BANDIT	400	1989	1996	R
		M GS E	500	1989	2003	R
		M GS F	500	2004	2007	R
FMD0248	SUZUKI	M GSX F	600	1988	1997	R
		M GSX	750	1989	1992	R
FMD0249	SUZUKI	M VX	800	1990	1993	R
		M VX	800	1994		R
		M RM	125	2001	2012	R
FMD0250	SUZUKI	M RM	250	2001	2012	R
		M DR Z SM	400	2005	2017	R
		M GSX R	600	1997	2003	R
		M GSX R	600	2004	2005	R
		M GSX R	600	2006	2007	R
		M GSX R	600	2008	2017	R
		M GSX R (Rad.cal)	600	2004	2005	R
		M GSX R (Rad.cal)	600	2006	2007	R
		M SV	650	2003	2010	R
		M SV S	650	2003	2009	R
FMD0251	SUZUKI	M GSX R	750	1996	2003	R
		M GSX R	750	2004	2005	R
		M GSX R	750	2006	2007	R
		M GSX R	750	2008	2017	R
		M GSX R (Rad.cal)	750	2004	2005	R
		M GSX R (Rad.cal)	750	2006	2007	R
		M GSX R Y	750	2000	2003	R
		M GSX R	1000	2001	2002	R
		M GSX R	1000	2003	2004	R
		M GSX R	1000	2005	2008	R
		M GSX R	1000	2009	2015	R
		M GSX R (Rad.cal)	1000	2005	2008	R
		M GSX R ABS	1000	2016		R
		M SV	1000	2003	2007	R
		M SV S	1000	2003	2007	R
		M TL R	1000	1998	2003	R
		M TL S	1000	1997	2001	R
M GSX R	1100	1987	1988	R		
FMD0252	SUZUKI	S BURGMAN	250	1996	1997	R
		S BURGMAN	250	1998	2002	R
		S BURGMAN AN	400	1999	2002	R
FMD0253	KAWASAKI	M KX	80	1993	2000	R
		M KX	85	2001	2015	R
		M KX	100	2001	2014	R
		M RM	80	1990	2001	R
		M RM	85	2002	2004	R
FMD0254	YAMAHA	M XT	600	1987	1990	R
		M XT 4 VALVES	600	1988	1989	R
		M XT E	600	1990	1994	R
		M XT E	600	1995	1996	R
		M XT E	600	1997	2003	R
		M XT Z TENERE	600	1987	1991	R
		M XTZ TENERE	660	1991	1991	R
		M XTZ TENERE	660	1992	1998	R
FMD0255	YAMAHA	M RD LC	500	1984	1988	R
		M XTZ SUPER TENERE	750	1989	2000	R
FMD0256	HRD YAMAHA	M GS 97	250	1997		R
		M WR	125	1998	2000	R
		M WR	125	2001	2002	R



CC FROM TO FRONT / REAR

Code	Brand	Model	CC	FROM	TO	FRONT / REAR		
...FMD0258		M YZ	125	1998	2001	R		
		M WR	250	1998	2000	R		
		M WR F	250	2001	2001	R		
		M YZ	250	1998	2000	R		
		M YZ	250	2001	2002	R		
		M YZ F	250	2001	2001	R		
		M YZ- WR	250	1998		R		
		M YZ-F	400	1998	2000	R		
		M WR F	426	2000	2000	R		
		M WR F	426	2001	2002	R		
		M YZ-F	426	2000	2000	R		
		FMD0261	YAMAHA	M YZF R6	600	1999	2002	R
				M YZF R1	1000	2002	2003	R
FMD0263	YAMAHA	M WR	125	2002	2005	R		
		M YZ	125	2002	2007	R		
		M YZ	125	2008	2016	R		
		M YZ	125	2017		R		
		M WR	250	2001	2008	R		
		M WR F	250	2002	2013	R		
		M WR F EFI	250	2015		R		
		M YZ	250	2002	2007	R		
		M YZ	250	2008	2016	R		
		M YZ F	250	2002	2006	R		
		M YZ F	250	2007	2015	R		
		M YZ F	250	2016		R		
		M YZ F EFI	250	2014	2015	R		
		M YZ FX	250	2016		R		
		M YZ X	250	2016		R		
		M WR F	400	2001	2002	R		
		M YZ-F	426	2001	2002	R		
		M WR F	450	2003	2015	R		
		M WR F	450	2016		R		
		M YZ-F	450	2003	2007	R		
		M YZ-F	450	2008	2015	R		
		M YZ-F	450	2016		R		
FMD0265	YAMAHA	M YZF R6	600	2003	2004	R		
		M YZF R6	600	2005	2016	R		
		M YZF R1	1000	2004	2006	R		
		M YZF R1	1000	2007	2014	R		
FMD0266	HARLEY D.	M XL 883 L SPORTSTER LOW	883	2007	2013	F		
		M XL 883 N IRON	883	2009	2013	F		
		M XL 883 R ROADSTER	883	2010	2011	F		
		M XL 883 R SPORTSTER	883	2000	2003	F		
		M XL 883 R SPORTSTER R	883	2005	2013	F		
		M XL 883 SPORTSTER CUSTOM	883	2004	2010	F		
		M XL SPORTSTER CUSTOM 53	883	2000	2003	F		
		M XLH 883 SPORTSTER	883	2000	2006	F		
		M XLH 883 SPORTSTER HUGGER	883	2000	2003	F		
		M XLR 883 CUSTOM 53	883	2001		F		
		M XL 1200 C SPORTSTER CUSTOM	1200	2004	2013	F		
		M XL 1200 L SPORTSTER LOW	1200	2007	2013	F		
		M XL 1200 R SPORTSTER ROADSTER	1200	2004	2008	F		
		M XL 1200 S SPORT	1200	2000	2003	F		
		M XL 1200 SPORTSTER	1200	2004	2006	F		
		M XL 1200 SPORTSTER - FORTY EIGHT	1200	2010	2011	F		
		M XL 1200 SPORTSTER CUSTOM	1200	2000	2003	F		
		M XL 1200 SPORTSTER N NIGHTSTER	1200	2007	2013	F		
		M XL 1200 V - SEVENTY TWO	1200	2012	2013	F		
		M XL 1200 X - FORTY EIGHT	1200	2010	2013	F		
		M XLH 1200 SPORTSTER	1200	2000	2003	F		
		M XR	1200	2008	2010	F		
		M XR 1200 X	1200	2010	2012	F		
		M FLSTC 1340 HERITAGE SOFTAIL CLASSIC	1340	2000	2002	F		
		M FLSTC FAT BOY	1340	2000	2002	F		
		M FXLR 1340 LOW RIDER CUSTOM	1340	2000		F		
		M FXSTS 1340 SPRINGER SOFTAIL	1340	2000	2002	F		
		M FLHR/I ROAD KING	1450	2000	2007	F		
		M FLHRC/I ROAD KING CLASSIC	1450	2000	2006	F		
		M FLHT/I ELECTRA GLIDE STANDARD	1450	2000	2006	F		
		M FLHTCUI ELECTRA GLIDE ULTRA CLASSIC	1450	2000	2006	F		
		M FLSTC HERITAGE SOFTAIL CLASSIC	1450	2000	2006	F		
		M FLSTF FAT BOY	1450	2000	2006	F		
		M FLSTS HERITAGE SPRINGER	1450	2000	2003	F		
		M FLTR/I ROAD GLIDE	1450	2000	2007	F		
		M FXD DYNA SUPER GLIDE	1450	2000	2003	F		
		M FXDL DYNA LOW RIDER	1450	2000	2006	F		
		M FXDS DYNA SUPER GLIDE SPORT	1450	2000		F		
		M FXDWG DYNA WIDE GLIDE	1450	2000	2005	F		



CC FROM TO FRONT / REAR

Code	Brand	Model	CC	FROM	TO	FRONT / REAR		
		M FXDX DYNA SUPER GLIDE T-SPORT	1450	2000	2005	F		
		M FXST SOFTAIL STANDARD	1450	2000	2007	F		
		M FXSTB/I NIGHT TRAIN	1450	2000	2007	F		
		M FXSTD/I SOFTAIL DEUCE	1450	2000	2006	F		
		M FXSTS/I SPRINGER SOFTAIL	1450	2000	2006	F		
		M FLHRC ROAD KING CLASSIC	1584	2007		F		
		M FLHT/I ELECTRA GLIDE STANDARD	1584	2007	2007	F		
		M FLHTCU ELECTRA GLIDE ULTRA CLASSIC	1584	2007	2008	F		
		M FLHX STREET GLIDE	1584	2006	2007	F		
		M FLSTB FAT BOY SPECIAL	1584	2010	2013	F		
		M FLSTB SOFTAIL CROSS BONES	1584	2008	2011	F		
		M FLSTC HERITAGE SOFTAIL CLASSIC	1584	2007	2014	F		
		M FLSTF FAT BOY	1584	2007	2014	F		
		M FLSTN SOFTAIL DELUXE	1584	2005	2014	F		
		M FXCW ROCKER	1584	2008	2009	F		
		M FXCWC ROCKER C	1584	2008	2013	F		
		M FXS BLACKLINE	1584	2011	2013	F		
		M FXSTB NIGHT TRAIN	1584	2008	2010	F		
		M FXSTC SOFTAIL CUSTOM	1584	2008	2010	F		
		M FLS SOFTAIL SLIM	1690	2012	2014	F		
		M FLTSE CVO SOFTAIL CONVERTIBLE	1800	2010	2011	F		
		M FXSTS CVO SOFTAIL SPRINGER	1800	2009		F		
		FMD0267	HARLEY D.	M XL 883 SPORTSTER CUSTOM	883	2004	2010	R
				M XL SPORTSTER CUSTOM 53	883	2000	2003	R
				M XLH 883 SPORTSTER	883	2000	2006	R
				M XLH 883 SPORTSTER HUGGER	883	2000	2003	R
				M XLR 883 CUSTOM 53	883	2001		R
				M XL 1200 C SPORTSTER CUSTOM	1200	2004	2013	R
				M XL 1200 R SPORTSTER ROADSTER	1200	2004	2008	R
		M XL 1200 S SPORT	1200	2000	2003	R		
		M XL 1200 SPORTSTER	1200	2004	2006	R		
		M XL 1200 SPORTSTER - FORTY EIGHT	1200	2010	2011	R		
		M XL 1200 SPORTSTER CUSTOM	1200	2000	2003	R		
		M XLH 1200 SPORTSTER	1200	2000	2003	R		
		M FLSTC 1340 HERITAGE SOFTAIL CLASSIC	1340	2000	2002	R		
		M FLSTC FAT BOY	1340	2000	2002	R		
		M FXLR 1340 LOW RIDER CUSTOM	1340	2000		R		
		M FXSTS 1340 SPRINGER SOFTAIL	1340	2000	2002	R		
		M FLHR/I ROAD KING	1450	2000	2007	R		
		M FLHRC/I ROAD KING CLASSIC	1450	2000	2006	R		
		M FLHT/I ELECTRA GLIDE STANDARD	1450	2000	2006	R		
		M FLHTCUI ELECTRA GLIDE ULTRA CLASSIC	1450	2000	2006	R		
		M FLSTC HERITAGE SOFTAIL CLASSIC	1450	2000	2006	R		
		M FLSTF FAT BOY	1450	2000	2006	R		
		M FLSTS HERITAGE SPRINGER	1450	2000	2003	R		
		M FLTR/I ROAD GLIDE	1450	2000	2007	R		
		M FXD DYNA SUPER GLIDE	1450	2000	2003	R		
		M FXDC DYNA SUPER GLIDE CUSTOM	1450	2006	2007	R		
		M FXDL DYNA LOW RIDER	1450	2000	2006	R		
		M FXDS DYNA SUPER GLIDE SPORT	1450	2000		R		
		M FXDWG DYNA WIDE GLIDE	1450	2000	2005	R		
		M FXDWG DYNA WIDE GLIDE	1450	2006	2007	R		
		M FXDX DYNA SUPER GLIDE T-SPORT	1450	2000	2005	R		
		M FXST SOFTAIL STANDARD	1450	2000	2007	R		
		M FXSTB/I NIGHT TRAIN	1450	2000	2007	R		
		M FXSTD/I SOFTAIL DEUCE	1450	2000	2006	R		
		M FXSTS/I SPRINGER SOFTAIL	1450	2000	2006	R		
		M FLHRC ROAD KING CLASSIC	1584	2007		R		
		M FLHT/I ELECTRA GLIDE STANDARD	1584	2007	2007	R		
		M FLHTCU ELECTRA GLIDE ULTRA CLASSIC	1584	2007	2008	R		
		M FLHX STREET GLIDE	1584	2006	2007	R		
		M FLSTB FAT BOY SPECIAL	1584	2010	2013	R		
		M FLSTB SOFTAIL CROSS BONES	1584	2008	2011	R		
		M FLSTC HERITAGE SOFTAIL CLASSIC	1584	2007	2014	R		
		M FLSTF FAT BOY	1584	2007	2014	R		
		M FLSTN SOFTAIL DELUXE	1584	2005	2014	R		
		M FXCW ROCKER	1584	2008	2009	R		
		M FXCWC ROCKER C	1584	2008	2013	R		
		M FXD DYNA SUPER GLIDE	1584	2008	2010	R		
		M FXDB DYNA STREET BOB	1584	2006	2010	R		
		M FXDB DYNA STREET BOB	1584	2008	2014	R		
		M FXDC DYNA SUPER GLIDE CUSTOM	1584	2008	2014	R		
		M FXDF FAT BOB	1584	2008	2014	R		
		M FXDL DYNA LOW RIDER	1584	2007	2010	R		
		M FXDWG DYNA WIDE GLIDE	1584	2008	2014	R		
		M FXS BLACKLINE	1584	2011	2013	R		

M = MOTORCYCLE
S = SCOOTER
A = ATV
Sn = SNOWMOBILE



FRONT
/ REAR

CC	FROM	TO	FRONT / REAR
...FMD0267	M	FXSTB NIGHT TRAIN	1584 2008 2010 R
	M	FXSTC SOFTAIL CUSTOM	1584 2008 2010 R
	M	FLD SWITCHBACK	1690 2012 2014 R
	M	FLS SOFTAIL SLIM	1690 2012 2014 R
	M	FLS SOFTAIL SLIM ABS	1690 2016 2017 R
	M	FLSTC HERITAGE SOFTAIL CLASSIC ABS	1690 2016 2017 R
	M	FLSTF FAT BOY	1690 2015 2017 R
	M	FLSTF FAT BOY SPECIAL	1690 2015 2017 R
	M	FLSTN SOFTAIL DELUXE ABS	1690 2015 2017 R
	M	FXDB DYNA STREET BOB ABS	1690 2014 2017 R
	M	FXSB BREAKOUT	1690 2015 2017 R
	M	FLS SOFTAIL SLIM S	1800 2015 2016 R
	M	FLSS SOFTAIL SLIM S ABS	1800 2016 2017 R
	M	FLSTFBS FAT BOY S	1800 2016 2017 R
	M	FLSTSE CVO SOFTAIL CONVERTIBLE	1800 2010 2011 R
	M	FXSTSS CVO SOFTAIL SPRINGER	1800 2009 R
FMD0271	HONDA	S CH SPACY (spessore disco 4mm)	250 2000 F
		S CN	250 1987 1998 F
FMD0274	YAMAHA	A YFS BLASTER	200 1988 2002 R
		A YFS R BLASTER	200 2003 2006 R
		A YFZ BANSHEE	350 1987 2009 R
		A YFM RN RAPTOR	660 2001 2005 R
FMD0275	YAMAHA	M SR (Rear Drum Model)	400 2014 2015 F
		M XVS VIRAGO (Rear Drum Model)	535 1996 2000 F
		M XVS DRAG STAR	600 1997 F
		M XVS DRAG STAR (Rear Drum Model)	650 1997 2004 F
		M XVS DRAG STAR CLASSIC (Rear Drum Model)	650 1998 2007 F
		M XVS DRAG STAR	1100 1999 2006 F
		M V MAX	1200 1993 2006 F
		M XVZ TF ROYAL STAR VENTURE	1300 1996 2007 F
		M XVZ13TF WILD STAR	1300 1999 F
		M XVS ROAD STAR	1600 1999 2007 F
		M XVS WILD STAR	1600 1999 2007 F
		M XV ROADLINER	1900 2006 F
FMD0279	KTM	M LC4 ADVENTURE	620 1997 1998 F
		M LC4 ADVENTURE	640 1998 2000 F
		M LC4 ADVENTURE	640 2004 2007 F
		M LC4 ENDURO	640 1999 2007 F
		M ENDURO	690 2008 2010 F
		M ENDURO R	690 2008 2013 F
		M LC8 ADVENTURE	950 2002 2006 F
		M LC8 ADVENTURE S	950 2004 2006 F
		M SUPER ENDURO R	950 2006 2008 F
		M LC8 ADVENTURE R	990 2010 2012 F
		M LC8 ADVENTURE S	990 2006 2008 F
FMD0281	YAMAHA	M YZF R6	600 2017 F
		M FZ1	1000 2006 2012 F
		M FZ1	1000 2013 2014 F
		M FZ1 FAZER	1000 2006 2012 F
		M FZ1 FAZER ABS	1000 2007 2012 F
		M MT-10 ABS	1000 2016 2017 F
		M MT-10 SP ABS	1000 2017 F
		M YZF R1	1000 2004 2006 F
		M YZF R1	1000 2015 2017 F
		M YZF R1 60TH ANNIVERSARY EDITION	1000 2016 F
		M YZF R1M	1000 2015 2017 F
		M V MAX	1700 2009 2016 F
		M XV-Y	1700 2009 2016 F
FMD0312	CAGIVA	M MITO	50 1998 2001 R
		M PRIMA R	75 1998 2001 R
	DERBI	M GPR R	50 1997 2001 R
FMD0315	BETA	M RK 6 T	50 1998 F
FMD0317	BETA	M MX R ENDURO	50 1995 1996 R
		M RK 6 - E	50 1995 1997 R
		M RK ADVENTURE	50 1995 1996 R
FMD0318	SUZUKI	S BURGMAN UH	125 2002 2006 R
		S BURGMAN UH	150 2002 2006 R
FMD0319	MBK	S KILIBRE	300 2003 2006 F
	YAMAHA	S VERSITY XC	300 2003 2006 F
FMD0320	MBK	S KILIBRE	300 2003 2006 R
	YAMAHA	S X-CITY VP	125 2008 2011 R
		S X-MAX YP R	125 2006 2009 R
		S X-MAX YP R	125 2010 2013 R
		S X-CITY VP	250 2007 2014 R
		S X-MAX YP R	250 2005 2013 R
		S X-MAX YP R SPORT	250 2011 2012 R
		S VERSITY XC	300 2003 2006 R
FMD0323	KYMCO	S AGILITY 4T R 16	50 2008 F



FRONT
/ REAR

CC	FROM	TO	FRONT / REAR
	S	PEOPLE S	50 2005 2008 F
	S	PEOPLE S 4T	50 2006 2008 F
	S	AGILITY i R16 PLUS	125 2016 2017 F
	S	AGILITY R16	125 2008 2017 F
	S	AGILITY R16 PLUS	125 2014 2017 F
	S	AGILITY R16 PLUS CBS	125 2017 2019 F
	S	PEOPLE GTi 125	125 2010 2011 F
	S	PEOPLE S	125 2005 2006 F
	S	PEOPLE S DD	125 2007 2008 F/R
	S	AGILITY i R16	150 2008 2017 F
	S	AGILITY i R16 PLUS	150 2014 2017 F
	S	AGILITY i R16 PLUS ABS	150 2018 2019 F
	S	AGILITY R16	200 2009 2016 F
	S	AGILITY R16i PLUS	200 2014 2017 F
	S	PEOPLE GT 200i	200 2010 2011 F/R
	S	PEOPLE S	200 2005 2006 F
	S	PEOPLE S i	200 2007 2015 F/R
	S	PEOPLE L.C.	250 2003 2006 F/R
	S	PEOPLE S i	250 2006 2010 F/R
	S	PEOPLE S i	300 2008 2010 F/R
FMD0324	SUZUKI	S BURGMAN UH	125 2002 2006 F
		S BURGMAN UH	150 2002 2006 F
FMD0325	YAMAHA	M TZR	50 1996 2002 R
FMD0326	APRILIA	S ATLANTIC	125 2003 2011 F
		S ARECIFE (spagna)	200 2003 F
		S ATLANTIC	200 2003 2005 F
		S ATLANTIC	250 2003 2006 F
		S ATLANTIC	300 2010 2011 F
	BENELLI	S VELVET	250 1999 F
		S VELVET TOURING	250 2001 F
		S VELVET DUSK	400 2003 F
FMD0327	APRILIA	S ATLANTIC	125 2003 2011 R
		S ARECIFE (spagna)	200 2003 R
		S ATLANTIC	200 2003 2005 R
		S ATLANTIC	250 2003 2006 R
		S ATLANTIC	300 2010 2011 R
FMD0328	KAWASAKI	M KL TENGAI	650 1989 1992 F
		M KLR	650 1995 2004 F
FMD0330	SHERCO	M SE ENDURO 2.5 I	250 2006 2011 F
		M ENDURO 4.5 I	450 2004 2011 F
		M SE ENDURO 5.1 I	510 2006 2011 F
FMD0332	GAS GAS	M TXT PRO RACING	125 2014 F
		S TXT PRO RACING	250 2014 F
		M TXT PRO RACING	280 2014 F
		M TXT PRO RACING	300 2014 F
	MONTESA	M COTA 4RT	250 2005 2013 F
		M COTA 4RT	260 2014 2014 F
		M COTA 4RT	260 2015 F
	SHERCO	M CITY CORP 4T ENDURO	125 2003 F
		M CITY CORP 4T SM	125 2003 F
		M TRIAL	125 1999 F
		M TRIAL 1.25	125 2006 F
		M TRIAL 2.5	250 2001 F
		M TRIAL 2.9	290 2001 F
		M TRIAL 3.2 4T	320 2005 F
	VERTIGO	M COMBAT CAMO	300 2015 F
		M COMBAT ICE HELL	300 2015 F
FMD0333	SHERCO	M CITY CORP 4T ENDURO	125 2003 R
		M CITY CORP 4T SM	125 2003 R
		M TRIAL	125 1999 R
		M TRIAL 1.25	125 2006 R
		M TRIAL 2.5	250 2001 R
		M TRIAL 2.9	290 2001 R
		M TRIAL 3.2 4T	320 2005 R
FMD0334	SUZUKI	S BURGMAN AN	250 2003 2006 F
		S BURGMAN AN	400 2003 2006 F
		S BURGMAN AN	400 2007 2015 F
		M BURGMAN AN ABS	400 2011 2019 F
		S BURGMAN AN (5 fori / holes)	650 2004 2012 F
		S BURGMAN AN ABS	650 2004 2015 F
		S BURGMAN AN ABS EXECUTIVE	650 2013 2018 F
FMD0335	BETA	M RR 250	250 2005 2012 R
		M RR 4T ENDURO 350	350 2012 2012 R
		M RR	400 2005 2012 R
		M RR	450 2005 2012 R
		M RR CROSS COUNTRY	450 2012 R
		M RR	525 2005 2012 R
	HUSQVARNA	M CR	125 2004 2013 R

13020

FERODO

RACING

Updated on November 2020

M = MOTORCYCLE
S = SCOOTER
A = ATV
Sn = SNOWMOBILE



FRONT
/ REAR

CC FROM TO

Code	Brand	Model	CC	From	To	Front / Rear		
...FMD0335	SHERCO	WR	125	2004	2013	R		
		CR	250	2004	2013	R		
		TC	250	2002	2013	R		
		TXC	250	2011	2014	R		
		SMR 449	449	2011	2012	R		
		TC	450	2007	2010	R		
		TE	450	2006	2010	R		
		TXC	450	2011	2013	R		
		SMR 510	510	2006	2010	R		
		TC	510	2007	2009	R		
		TE	510	2006	2010	R		
		TXC	510	2009	2010	R		
		SMR 511	511	2011	2012	R		
		TE	511	2011	2013	R		
		TXC	511	2011	2013	R		
		SE ENDURO 2.5 I	250	2006	2011	R		
		ENDURO 4.5 I	450	2004	2011	R		
		SE ENDURO 5.1 I	510	2006	2011	R		
		RS 300 R	298	2015	2017	R		
		FMD0342	SUZUKI	RM	85	2005	2007	R
		FMD0349	SUZUKI	GSX F	600	2004	2006	F
GSF BANDIT	650			2005	2006	F		
GSF BANDIT S	650			2005	2006	F		
SV	650			2003	2010	F		
SV S	650			2003	2009	F		
GSX F	750			2004	2006	F		
FMD0350	KAWASAKI	ZX6R NINJA	600	2007	2016	F		
		ZX6RR NINJA	600	2005	2006	F		
		ZX6R NINJA	636	2005	2006	F		
		ER6F (No ABS)	650	2006	2015	F		
		ER6N NO ABS	650	2006	2015	F		
		VERSYS (NO ABS)	650	2007	2014	F		
		Z 750	750	2007	2012	F		
		Z 750 R	750	2011	2012	F		
		VERSYS	1000	2012	2014	F		
		Z 1000	1000	2007	2013	F		
		Z 1000 SX	1000	2011	2016	F		
		ZX-10R	1000	2004	2007	F		
		FMD0352	APRILIA	RSV	1000	2001	2002	F
				RSV	1000	2002	2003	F
				RSV FACTORY	1000	2003	2007	F
RSV R	1000			2001	2005	F		
RSV R	1000			2006	2008	F		
RSV4 FACTORY	1000			2009	2010	F		
RSV4 FACTORY APRC	1000			2011	2012	F		
RSV4 FACTORY APRC ABS	1000			2013	2014	F		
RSV4 R	1000			2009	2009	F		
RSV4 R	1000			2010	2010	F		
RSV4 R APRC	1000			2011	2012	F		
RSV4 R APRC ABS	1000			2013	2014	F		
RSV4 RR	1000			2015	2016	F		
TUONO	1000			2002	2005	F		
TUONO R (4 pads per caliper)	1000			2002	2005	F		
TUONO V4 FACTORY	1100		2015	2016	F			
BENELLI	TUONO V4 RR		1100	2015	2016	F		
	TORNADO TRE		900	2003	2006	F		
	TORNADO TRE RS		900	2004	2006	F		
	CAFE RACER		1130	2006	2015	F		
	TITANIUM		1130	2005	2007	F		
	TNT RS		1130	2005	2007	F		
	TORNADO		1130	2006		F		
	TORNADO NAKED TRE R		1130	2016		F		
	SB8K SANTAMONICA		1000	2006		F		
	998 S (four pads)		998	2002	2003	F		
	BIMOTA		LC4 SUPERMOTO Prestige	690	2007	2007	F	
			SUPERMOTO R	690	2008	2008	F	
SUPER DUKE			990	2005	2011	F		
SUPER DUKE R			990	2007	2013	F		
DUCATI	YZF R		750	1993	1997	F		
	YZF SP		750	1993	1997	F		
KTM	YZF R		750	1993	1997	F		
	YZF SP	750	1993	1997	F			
YAMAHA	YZF R	750	1993	1997	F			
	YZF SP	750	1993	1997	F			
FMD0353	BOMBARDIER	DS X	650	2001	2002	F		
FMD0361	SUZUKI	BURGMAN AN	250	2003	2006	R		
		BURGMAN AN	400	2003	2006	R		
FMD0362	SUZUKI	BURGMAN AN (5 fori / holes)	650	2004	2012	R		
		BURGMAN AN ABS	650	2004	2015	R		
		BURGMAN AN ABS EXECUTIVE	650	2013	2018	R		
FMD0363	MBK	YW BOOSTER	100	1999	2001	F		
		XC FLAME R	125	1996	1999	F		

M = MOTORCYCLE
S = SCOOTER
A = ATV
Sn = SNOWMOBILE



FRONT
/ REAR

CC FROM TO

Code	Brand	Model	CC	From	To	Front / Rear
...	YAMAHA	BW S	100	1999	2001	F
		CYGNUS R XC	125	1999	2003	F
		CYGNUS R XC K	125	1997	1998	F
		FLY ONE R XC	150	1998		F
FMD0365	DERBI	DRD Racing SM PRO EU2	50	2005	2009	F
		DRD SM PRO EU2	50	2005	2008	F
		GPR NUDE	50	2006	2008	F
		GPR NUDE SPORT	50	2008		F
		GPR NUDE TUNING	50	2006	2008	F
		GPR R EU2 - REPLICA EU2	50	2008		F
		GPR RACING EU2	50	2006		F
		GPR REPLICA - R EU2	50	2006		F
		GPR REPLICA 2T	50	2007		F
		GPR REPLICA PESEK EU2	50	2007		F
		GPR NUDE	125	2004	2006	F
		GPR RACING	125	2004	2006	F
FMD0366	SUZUKI	RMZ	250	2007	2018	R
		RMX EFI	450	2010	2012	R
		RMZ	450	2005	2007	R
		RMZ EFI	450	2008	2017	R
FMD0367	YAMAHA	RMZ EFI	450	2018		R
FMD0369	MALAGUTI	X-MAX ABS YP RA 125	125	2014	2017	F
		X-MAX ABS YP RA 125	125	2018	2019	F
		X-MAX YP R IRON MAX ABS	250	2016	2016	F
		X-MAX YP RA ABS	250	2014	2016	F
		YP G GRAND MAJESTY [japan]	250	2004	2005	F
		X-MAX (SH08 - CDZ)	300	2017		F
		X-MAX Iron Max (CDZ)	300	2019		F
		FAZER 8	800	2010	2012	R
		FZ8 N 800	800	2011	2015	R
		FZ8 NA 800	800	2011	2012	R
FMD0371	MALAGUTI	FZ8 S FAZER 800	800	2011		R
		FZ8 SA FAZER 800	800	2011		R
FMD0375	GAS GAS	PASSWORD	250	2005	2006	F
		PASSWORD EU 3	250	2007	2008	F
		SPIDERMAX GT	500	2004	2005	F
		SPIDERMAX GT EURO 3	500	2006		F
		SPIDERMAX RS	500	2008		F
FMD0377	GAS GAS	MADISON 3	125	2006	2009	F/R
		MADISON 3	250	2006	2009	F/R
		PASSWORD	250	2005	2006	R
		PASSWORD EU 3	250	2007	2008	R
FMD0378	GAS GAS	TXT	125	2001	2003	R
		TXT	200	2000	2003	F
		TXT	250	2000	2003	F
		TXT	280	2000	2003	F
FMD0381	SCORPA	TXT PRO	125	2004	2013	F
		TXT PRO	200	2004	2013	F
		TXT PRO	250	2004	2013	F
		TXT	280	2004	2013	F
		TXT	300	2004	2009	F
		TXT	125	2001	2003	R
		TXT PRO	125	2004	2013	R
		TXT PRO RACING	125	2014		R
		TXT	200	2000	2003	R
		TXT PRO	200	2004	2013	R
		TXT	250	2000	2003	R
		TXT PRO	250	2004	2013	R
FMD0382	SCORPA	TXT PRO RACING	250	2014		R
		TXT	280	2000	2003	R
		TXT	280	2004	2013	R
		TXT PRO RACING	280	2014		R
FMD0383	SCORPA	TXT	300	2004	2009	R
		TXT PRO RACING	300	2014		R
		COTA 4RT	250	2005	2013	R
		COTA 4RT	260	2014	2014	R
FMD0384	SCORPA	COTA 4RT	260	2015		R
		COMBAT CAMO	300	2015		R
FMD0385	SCORPA	COMBAT ICE HELL	300	2015		R
FMD0386	SCORPA	SY F	125	2003		F
		TY (4T)	125	2005		F
		SY F RACING	175	2005		F
FMD0387	SCORPA	SY	250	2000		F
		SY LONG RIDE	250	2004		F
		SY R	250	2005		F
FMD0388	SCORPA	SY F	125	2003		R
		TY (4T)	125	2005		R
		SY F RACING	175	2005		R



FRONT
/ REAR

CC	FROM	TO	FRONT / REAR
...FMD0382	M SY	250 2000	R
	M SY LONG RIDE	250 2004	R
	M SY R	250 2005	R
FMD0389	DUCATI	748 2003	2006 R
	M 749	748 2004	2006 R
	M 749 DARK	748 2004	2006 R
	M 749 R	748 2004	2006 R
	M 749 S	748 2003	2006 R
	M 999	998 2003	2006 R
	M 999 S	998 2002	2007 R
	M 999 R	999 2003	2006 R
FMD0390	DUCATI	795 2013	R
	M MONSTER	800 2010	2012 R
	M HYPERMOTARD 796	800 2011	2014 R
	M MONSTER 796	800 2005	2007 R
	M MONSTER S2R	800 2005	2006 R
	M MONSTER S2R DARK	848 2008	2010 R
	M 848	848 2012	R
	M STREETFIGHTER	848 2012	R
	M STREETFIGHTER S	850 2011	2012 R
	M 848 EVO	996 2003	2006 R
	M MONSTER S4R	998 2007	R
	M S4R Testastretta MONSTER	998 2006	2007 R
	M S4RS Testastretta MONSTER	1000 2008	2008 R
	M MONSTER S2R	1000 2007	2008 R
	M MONSTER S4R	1000 2006	2008 R
	M MONSTER S4RS	1000 2008	R
	M MONSTER S4RS TRICOLORE	1000 2003	2006 R
	M MULTISTRADA	1000 2005	R
	M MULTISTRADA DS	1000 2005	R
	M MULTISTRADA DS S	1000 2006	R
	M MULTISTRADA S	1100 2008	2009 R
	M HYPERMOTARD	1100 2011	2012 R
	M HYPERMOTARD EVO	1100 2010	2012 R
	M HYPERMOTARD EVO SP	1100 2008	2009 R
	M MONSTER 1100 - ABS	1100 2009	2010 R
	M MONSTER 1100 S	1100 2013	R
	M MONSTER DIESEL	1100 2012	2013 R
	M MONSTER EVO	1100 2012	2013 R
	M MONSTER EVO - EVO ABS	1100 2013	R
	M MONSTER EVO ANNIVERSARY	1100 2010	R
	M MONSTER S ABS	1100 2007	2009 R
	M MULTISTRADA	1100 2007	2009 R
	M MULTISTRADA S	1800 2008	2012 F
FMD0393	SUZUKI	600 2006	2007 F
	M GSX R	600 2006	2007 F
	M GSX R (Rad.cal)	750 2006	2007 F
	M GSX R	750 2006	2007 F
	M GSX R (Rad.cal)	1000 2005	2008 F
	M GSX R	1000 2005	2008 F
	M GSX R (Rad.cal)	1800 2008	2012 F
	M VZR INTRUDER M	600 2005	2016 F
FMD0394	YAMAHA	800 2010	2012 F
	M YZF R6	800 2013	2015 F
	M FAZER 8	800 2010	2010 F
	M FAZER 8	800 2011	2015 F
	M FZ8 N 800	800 2011	2015 F
	M FZ8 N 800	800 2011	2015 F
	M FZ8 NA 800	800 2013	2015 F
	M FZ8 NA 800	800 2011	F
	M FZ8 SA FAZER 800	1000 2007	2014 F
	M YZF R1	1200 2010	2019 F
	M XT Z SUPER TENERE	1200 2016	F
	M XT Z SUPER TENERE WORLDCROSSER	1200 2014	2019 F
FMD0396	SUZUKI	250 2007	2018 F
	M RMZ	450 2010	2012 F
	M RMX EFI	450 2005	2007 F
	M RMZ	450 2008	2017 F
FMD0397	YAMAHA	125 2004	2006 F
	S CYGNUS X NXC	50 2009	2016 F
FMD0398	GILERA	50 2017	2018 F
	S RUNNER / BLACK SOUL	50 2012	2017 F
	S RUNNER 2T SP	50 2018	F
	S LIBERTY 2T / 4T	50 2016	2018 F
	S LIBERTY 4T / LIBERTY 4T S	50 2016	2018 F
	S NEW LIBERTY i-GET	50 2016	2016 F
	S NEW LIBERTY S i-GET	125 2009	2013 F
	S LIBERTY 4T	125 2006	2008 F
	M MP3 125	125 2009	2010 F
	S MP3 IBRIDO		



FRONT
/ REAR

CC	FROM	TO	FRONT / REAR
	S MP3 IE	125 2008	2009 F
	S MP3 IE TOURING	125 2011	2012 F
	S MP3 YOURBAN ERL	125 2011	2013 F
	S MP3	250 2006	2008 F
	S MP3 LT	250 2008	2009 F
	S MP3 MIC	300 2010	2017 F
	S MP3 300 HPE	300 2010	2011 F
	S MP3 4T 4V IE ERL IBRIDO	300 2010	2013 F
	S MP3 IE LT	300 2011	2013 F
	S MP3 IE LT - IE LT SPORT	300 2011	2013 F
	S MP3 IE LT TOURING	300 2010	2013 F
	S MP3 IE MIC	300 2011	2012 F
	S MP3 YOURBAN ERL	300 2011	2015 F
	S MP3 YOURBAN LT ERL	300 2011	2012 F
	S MP3	400 2007	2008 F
	S MP3 IE LT - IE LT SPORT	400 2008	2010 F
	S MP3 IE LT TOURING	400 2009	F
	S MP3 LT	400 2008	2010 F
	S MP3 MIC	400 2011	F
	S MP3 RL TOURING	400 2011	F
	S MP3 TOURING SPORT / BUSINESS	500 2012	2015 F
FMD0399	HUSQVARNA	85 2014	2015 F
	M TC 85 (17/14)	85 2003	2010 F
	M SX	85 2011	2015 F
	M SX	85 2008	2009 F
	M XC	105 2007	2008 F
	M XC	105 2008	2009 F
FMD0400	KTM	85 2003	2010 R
	M SX	85 2008	2009 R
	M SX	105 2004	2006 R
	M SX	105 2007	2008 R
	M SX	105 2009	R
	M XC	105 2008	2009 R
FMD0401	APRILIA	450 2005	2007 F
	M SXV	550 2005	2007 F
FMD0403	HONDA	1100 1990	1995 R
	M ST PAN EUROPEAN	1100 1992	1995 R
	M ST PAN EUROPEAN ABS	1500 1990	2000 R
	M GL GOLDWING	50 2001	2009 F
FMD0404	HONDA	50 2007	2009 F
	M HM CRE DERAPAGE	600 2004	2007 R
	M HM CRE DERAPAGE RR	600 2007	2008 R
FMD0405	YAMAHA	600 2004	2007 R
	M FZ6 FAZER	600 2007	2009 R
	M FZ6 FAZER S2	600 2007	2008 R
	M FZ6 S2	600 2009	2009 R
	M FZ6 S2	660 2006	2012 R
	M MT-03	1000 2006	2012 R
	M FZ1	1000 2006	2012 R
	M FZ1 FAZER	1000 2007	2012 R
	M FZ1 FAZER ABS	450 2005	2007 R
FMD0406	APRILIA	450 2005	2007 R
	M RXV 4.5	450 2008	R
	M SXV	550 2005	2007 R
	M SXV	550 2005	2007 R
	M RXV 5.5	550 2008	R
	M SXV	550 2005	2007 R
	M SXV	800 2008	R
FMD0407	BMW	800 2008	2012 R
	M F 650 GS (K72)	800 2008	2011 R
	M F 650 GS ABS (K72)	800 2013	2018 R
	M F 700 GS ABS	800 2009	2018 R
	M F 800 GS	800 2012	2019 R
	M F 800 GS ADVENTURE ABS	800 2013	2017 R
	M F 800 GT ABS	800 2009	2019 R
	M F 800 R	800 2006	2010 R
	M F 800 S	800 2006	2012 R
	M F 800 ST	850 2018	R
	M F 850 GS	850 2019	R
	M F 850 GS Adventure	853 2018	R
	M F 750 GS	1000 2015	2019 R
	M S 1000 XR	1200 2006	2009 R
	M HP2	1200 2007	2010 R
	M HP2 Megamoto	1200 2008	2011 R
	M HP2 SPORT	1200 2004	2008 R
	M K 1200 R	1200 2004	2007 R
	M K 1200 S / ABS	1200 2004	2012 R
	M R 1200 GS (R12)	1200 2004	2012 R
	M R 1200 GS ABS	1200 2006	2013 R
	M R 1200 GS ADVENTURE	1200 2006	2017 R
	M R 1200 R	1200 2011	2012 R
	M R 1200 R CLASSIC		

13022

FERODO
RACING
Updated on November 2020

M = MOTORCYCLE
S = SCOOTER
A = ATV
Sn = SNOWMOBILE



FRONT
/ REAR

CC FROM TO

Code	Brand	Model	CC	From	To	Front/Rear		
...FMD0407	HUSQVARNA	M R 1200 RT	1200	2005	2013	R		
		M R 1200 S	1200	2006	2008	R		
		M R 1200 ST	1200	2005	2008	R		
		M R NINE T	1200	2014	2019	R		
		M R NINE T PURE	1200	2014	2019	R		
		M R NINE T RACER	1200	2014	2019	R		
		M R NINE T SCRAMBLER	1200	2017	2019	R		
		M R NINE T URBAN G/S	1200	2017	2019	R		
		M K 1300 R - ABS	1300	2008	2014	R		
		M K 1300 S	1300	2009	2015	R		
		M NUDA	900	2012	2013	R		
		M NUDA R	900	2012	2013	R		
		M NUDA R ABS	900	2013		R		
FMD0409	HONDA	M NSR 50	50	1996	2001	F		
		M NSR 50 REPSOL	50	1996	2001	F		
		M NSR 75 (NS-1)	75	1994	1998	F		
		S FORZA ABS	125	2015	2019	F		
		S FORZA X NSS	250	2008		F		
		S FORZA XE NSS	250	2008		F		
		S FORZA ABS	300	2014	2018	F		
		S FORZA DELUXE ABS	300	2019		F		
		M SH 300 i ABS (NF05)	300	2015	2019	F		
		S SH i	300	2006	2014	F/R		
		S SH i ABS	300	2006	2014	F/R		
		M NSR R	400	1985	1988	F		
		S SILVER WING FJS	400	2006	2008	F		
		M VFR R	400	1987	1987	F		
		M VF F	500	1984	1987	F/R		
		S SILVER WING FSC	600	2001	2006	F		
		M VFR F INTERCEPTOR	750	1986	1987	R		
		M VFR F INTERCEPTOR	750	1988	1989	R		
		M CBR F-FP	1000	1993	1999	R		
		M XLV VARADERO	1000	2003	2011	R		
		M XLV VARADERO ABS	1000	2004	2011	R		
		M CB X-11	1100	2000	2003	R		
		M CBR XX BLACKBIRD	1100	1997	1998	R		
		M CBR XX SUPERBLACKBIRD	1100	1999	2008	R		
		M CB F SUPER FOUR	1300	2003	2004	R		
		M CB SUPER BOL DOR	1300	2005	2008	R		
		M CB SUPERFOUR	1300	2005	2009	R		
		FMD0410	KAWASAKI	M ZX6R NINJA	636	2013	2015	F
M ZX6R NINJA ABS	636			2013	2016	F		
M Z 800	800			2013	2015	F		
M Z 800 ABS	800			2013	2016	F		
M Z 800e	800			2013	2015	F		
M Z 800e ABS	800			2013	2016	F		
M VERSYS ABS	1000			2015	2017	F		
M Z 1000	1000			2014	2015	F		
M Z 1000 - ABS	1000			2014	2017	F		
M Z 1000 R EDITION ABS (Brembo caliper)	1000			2017	2018	F		
M ZX-10R	1000			2008	2010	F		
M ZX-10R	1000			2011	2015	F		
M ZX-10R ABS	1000			2011	2015	F		
M GTR	1400			2007	2015	F		
M GTR ABS	1400			2008	2016	F		
M ZZR	1400			2006	2007	F		
M ZZR ABS	1400			2006	2018	F		
M ZZR ABS Performance Sport	1400			2016	2018	F		
FMD0411	HONDA			M CBR RR Fireblade	1000	2008	2015	F
				M CBR RR Fireblade ABS	1000	2009	2016	F
		M CBR RR Fireblade SP	1000	2014	2016	F		
FMD0412	SUZUKI	M GSX R	600	2008	2017	F		
		M GSX R	750	2008	2017	F		
		M GSX R	1000	2009	2015	F		
		M GSX R ABS	1000	2016		F		
FMD0413	BENELLI	S ADIVA	125	2000	2002	R		
		S ADIVA	150	2000	2002	R		
FMD0415	PEUGEOT	S LOOXOR	50	2001	2005	F		
		S LOOXOR	50	2006		F		
		S LOOXOR	125	2002		F		
		S LOOXOR	150	2002	2003	F		
FMD0416	SYM	S EURO MX	125	2002		F		
		S EURO MX E2	125	2003	2004	F		
		S JOYRIDE	125	2001	2004	F		
		S JOYRIDE EURO 2	125	2005	2006	F		
		S JOYRIDE EURO 3	125	2007	2009	F		
		S JOYRIDE EVO	125	2010		F		
S SHARK	125	1999	1999	F				

M = MOTORCYCLE
S = SCOOTER
A = ATV
Sn = SNOWMOBILE



FRONT
/ REAR

CC FROM TO

Code	Brand	Model	CC	From	To	Front/Rear		
FMD0417	SYM	S SHARK	125	2000		F		
		S VS	125	2006		F		
		S VS EURO 3	125	2007	2008	F		
		S EURO MX	150	2002		F		
		S EURO MX EU 2	150	2003	2004	F		
		S JOYRIDE	150	2001	2002	F		
		S SHARK	150	2000	2001	F		
		S VS	150	2007		F		
		S VS EURO 3	150	2007	2008	F		
		S JOY RIDE	200	2001	2004	F		
		S JOY RIDE I EVO	200	2009	2010	F		
		FMD0418	SYM	M HD 125 EURO 2	125	2003	2004	F
				S HD EVO	125	2005	2006	F
S HD EU 2	200			2003	2004	F		
S HD EVO EURO 2	200			2005	2006	F		
FMD0419	SYM	S HD EVO I EURO 3	200	2007	2010	F		
		S GTS	125	2006	2007	R		
		S JOYRIDE	125	2001	2004	R		
		S JOYRIDE EURO 2	125	2005	2006	R		
		S JOYRIDE EURO 3	125	2007	2009	R		
		S JOYRIDE EVO	125	2010		R		
FMD0420	SYM	S JOYRIDE	150	2001	2002	R		
		S JOY RIDE	200	2001	2004	R		
		S JOY RIDE I EVO	200	2009	2010	R		
		S HD EVO	125	2005	2006	R		
		S HD EVO EURO3	125	2010		R		
		S HD EVO	200	2011		R		
		S HD EVO EURO 2	200	2005	2006	R		
		S HD EVO I EURO 3	200	2007	2010	R		
		S HD2 EVO	200	2013		R		
		S GTS	250	2006	2008	R		
		S JOYMAX	250	2005	2007	R		
		S JOYMAX I EURO 3	250	2007	2008	R		
		S JOYMAX EVO	300	2009		R		
FMD0421	SUZUKI	S JOYMAX I	300	2012		R		
		S JOYMAX I EVO	300	2010		R		
		S GTS	125	2006	2007	F		
		S GTS	250	2006	2008	F		
		S JOYMAX	250	2005	2007	F		
		S JOYMAX I EURO 3	250	2007	2008	F		
FMD0422	YAMAHA	S JOYMAX EVO	300	2009		F		
		S JOYMAX I	300	2012		F		
		S JOYMAX I EVO	300	2010		F		
		S BURGMAN AN	400	2007	2015	R		
		S BURGMAN AN ABS	400	2011	2019	R		
		M SR	200	1997		F		
		M RD F / N / R	350	1985	1993	F		
		M RD YPVS	350	1983	1984	F		
		M FZ N	400	1985		F		
		M XS	400	1982		F		
		M RD LC	500	1984	1988	F		
		S T MAX ABS XP	500	2008	2011	F		
		S T MAX SV ABS XP	500	2011	2011	F		
S T MAX SV XP	500	2011	2011	F				
S T MAX XP	500	2008	2011	F				
M XZ	550	1982	1984	F				
M FZ	600	1987	1988	F				
M SRX	600	1985	1987	F				
M XJ6 DIVERSION	600	1983	1991	F				
M YX RADIAN	600	1986	1990	F				
M XJ SEKA / XJ TURBO	650	1982	1983	F				
M FZX	700	1986	1987	F				
M FZ GENESIS	750	1987	1988	F				
M FZX FAZER	750	1986	1990	F				
M XJ	900	1987	1994	F				
M XV / XV SE VIRAGO	1000	1986		F				
M XV VIRAGO (Rear Drum Model)	1100	1986	1993	F				
FMD0423	KYMCO	S DINK 4T	50	2007		F		
		S DINK EURO 3	125	2006	2007	F		
		S DINK EURO 3 i	200	2006	2007	F		
		S NEW DINK	200	2008		F		
		S G-DINK	300	2012		F		
FMD0424	YAMAHA	S X-CITY VP	125	2008	2011	F		
		M VP 250 X-CITY	250	2007	2008	F		
		S X-CITY VP	250	2007	2014	F		
FMD0425	HONDA	S @ NES	125	2009		F		
		S PANTHEON FES	125	1998	2002	F		
		S PANTHEON FES	125	2003	2007	F		



CC FROM TO FRONT / REAR

Code	Brand	Model	CC	FROM	TO	FRONT / REAR		
...FMD0425	KEEWAY	S S-WING FES	125	2008		F		
		S SH i	125	2009	2019	F		
		S @ NES	150	2009		F		
		S PANTHEON FES	150	1998	2002	F		
		S PANTHEON FES	150	2003	2007	F		
		S S-WING FES	150	2007		F		
		S SH i	150	2009	2019	F		
		S SH i SPORTY	150	2009	2011	F		
		S FORESIGHT	250	1997	1998	F		
		S FORESIGHT	250	1999	2007	F		
		S FORZA NSS	250	2000	2004	F		
		S FORZA X NSS	250	2005	2007	F		
		S FORZA XE NSS	250	2005	2007	F		
		S JAZZ	250	2001	2004	F		
		S Efi - RE-EVOLUTION	125	2008	2012	F/R		
		S LOGIK / OUTLOOK	125	2008	2012	F/R		
		S LOGIK i 4T Efi CBS	125	2013		F		
		S OUTLOOK	150	2007	2008	F/R		
		S SV	250	2001		F		
		FMD0427	HONDA	M VF V TWIN MAGNA	250	1997	1997	F
M NT HAWK GT	650			1988	1990	F		
M NTV REVERE	650			1988	1998	F		
M VF C MAGNA	750			1994	2003	F		
M VF SHADOW	750			1994	2007	F		
M ST PAN EUROPEAN	1100			1996	2001	F		
M VT SHADOW	1100			1992	1995	F		
M VT SHADOW ACE-AERO-C2-C3	1100			1995	1998	F		
FMD0430	HARLEY D.			M STREET ROD	750	2017		F
				M XL 883 L SPORTSTER LOW ABS	883	2014	2016	F
		M XL 883 L SUPERLOW	883	2014	2017	F		
		M XL 883 N IRON	883	2014	2017	F		
		M CUSTOM 1200 ABS	1200	2015	2017	F		
		M SPORTSTER ROADSTER ABS	1200	2016	2017	F		
		M SUPERLOW 1200 T ABS	1200	2014	2017	F		
		M XL 1200 V - SEVENTY TWO ABS	1200	2014	2016	F		
		M XL 1200 X - FORTY EIGHT	1200	2014	2017	F		
		M FXDB DYNA STREET BOB	1450	2006	2007	F		
M FLHR/I ROAD KING	1584	2008	2010	F				
M FLHRC ROAD KING CLASSIC	1584	2008	2013	F				
M FLHT/I ELECTRA GLIDE STANDARD	1584	2008	2010	F				
M FLHTC ELECTRA GLIDE CLASSIC	1584	2008	2013	F				
M FLHTCU ELECTRA GLIDE ULTRA CLASSIC	1584	2009	2013	F				
M FLHX STREET GLIDE	1584	2008	2013	F				
M FLTR/I ROAD GLIDE	1584	2008	2009	F				
M FXDB DYNA STREET BOB	1584	2008	2014	F				
M FLHP ROAD KING POLICE	1690	2010	2011	F				
M FLHTK ELECTRA GLIDE ULTRA LIMITED	1690	2010	2013	F				
M FLHTP ELECTRA GLIDE POLICE	1690	2009	2011	F				
M FLHX STREET GLIDE	1690	2010	2013	F				
M FLS SOFTAIL SLIM ABS	1690	2016	2017	F				
M FLSTC HERITAGE SOFTAIL CLASSIC ABS	1690	2016	2017	F				
M FLSTF FAT BOY	1690	2015	2017	F				
M FLSTF FAT BOY SPECIAL	1690	2015	2017	F				
M FLSTN SOFTAIL DELUXE ABS	1690	2015	2017	F				
M FLTRU	1690	2011		F				
M FLTRUSE SCREAM EAGLE ROAD GLIDE	1690	2011		F				
M FLTRX ROAD GLIDE CUSTOM	1690	2010	2013	F				
M FXDB DYNA STREET BOB ABS	1690	2014	2017	F				
M FXDF FAT BOB	1690	2012	2017	F				
M FXDWG DYNA WIDE GLIDE ABS	1690	2014	2017	F				
M FXSB BREAKOUT	1690	2015	2017	F				
M ROAD KING CLASSIC	1690	2014	2015	F				
M ROAD KING CLASSIC ABS	1690	2016		F				
M FLXRC ROAD KING ABS	1750	2017		F				
M FLHTCUSE BLK ULTRA CLASSIC ELECTRA GLIDE	1800	2008	2013	F				
M FLHTCUSE CVO ULTRA CLASSIC ELECTRA GLIDE	1800	2009	2013	F				
M FLHXSE CVO STREET GLIDE	1800	2010	2011	F				
M FLS SOFTAIL SLIM S	1800	2015	2016	F				
M FLSS SOFTAIL SLIM S ABS	1800	2016	2017	F				
M FLSTFBS FAT BOY S	1800	2016	2017	F				
FMD0431	HARLEY D.	M VRSCA V-ROD	1130	2006	2008	F		
		M VRSCAW V-ROD	1250	2008	2010	F		
		M VRSCDX NIGHT ROD SPECIAL	1250	2007	2017	F		
		M VRSCF V-ROD MUSCLE	1250	2008	2017	F		
		M FXD DYNA SUPER GLIDE	1450	2006	2007	F		
		M FXDC DYNA SUPER GLIDE CUSTOM	1450	2006	2007	F		
		M FXDWG DYNA WIDE GLIDE	1450	2006	2007	F		
		M FXD DYNA SUPER GLIDE	1584	2008	2010	F		



CC FROM TO FRONT / REAR

Code	Brand	Model	CC	FROM	TO	FRONT / REAR
FMD0433	HARLEY D.	M FLHR/I ROAD KING	1584	2008	2010	R
		M FLHRC ROAD KING CLASSIC	1584	2008	2013	R
		M FLHT/I ELECTRA GLIDE STANDARD	1584	2008	2010	R
		M FLHTC ELECTRA GLIDE CLASSIC	1584	2008	2013	R
		M FLHTCU ELECTRA GLIDE ULTRA CLASSIC	1584	2009	2013	R
		M FLHX STREET GLIDE	1584	2008	2013	R
		M FLTR/I ROAD GLIDE	1584	2008	2009	R
		M ELECTRA GLIDE ULTRA CLASSIC ABS	1690	2016		R
		M FLHP ROAD KING POLICE	1690	2010	2011	R
		M FLHTK ELECTRA GLIDE ULTRA LIMITED	1690	2010	2013	R
		M FLHTP ELECTRA GLIDE POLICE	1690	2009	2011	R
		M FLHX STREET GLIDE	1690	2010	2013	R
		M FLTRU	1690	2011		R
		M FLTRUSE SCREAM EAGLE ROAD GLIDE	1690	2011		R
M FLTRX ROAD GLIDE CUSTOM	1690	2010	2013	R		
M FXDF FAT BOB	1690	2012	2017	R		
M FXDL LOW RIDER ABS	1690	2015	2017	R		
M FXDWG DYNA WIDE GLIDE ABS	1690	2014	2017	R		
M ROAD GLIDE SPECIAL ABS	1690	2016		R		
M ROAD GLIDE ULTRA ABS	1690	2016		R		
M ROAD KING ABS	1690	2016		R		
M ROAD KING CLASSIC	1690	2014	2015	R		
M ROAD KING CLASSIC ABS	1690	2016		R		
M STREET GLIDE SPECIAL ABS	1690	2016		R		
M ULTRA LIMITED ABS	1690	2016		R		
M ULTRA LIMITED LOW ABS	1690	2016		R		
M FLHR ROAD KING ABS	1750	2017		R		
M FLHTK ULTRA LIMITED ABS	1750	2017		R		
M FLHTKL ULTRA LIMITED LOW ABS	1750	2017		R		
M FLHXS STREET GLIDE SPECIAL ABS	1750	2017		R		
M FLTRU ROAD GLIDE ULTRA ABS	1750	2017		R		
M FLTRXS ROAD GLIDE SPECIAL ABS	1750	2017		R		
M FLXRC ROAD KING ABS	1750	2017		R		
M FLHTCUSE BLK ULTRA CLASSIC ELECTRA GLIDE	1800	2008	2013	R		
M FLHTCUSE CVO ULTRA CLASSIC ELECTRA GLIDE	1800	2009	2013	R		
M FLHXSE CVO STREET GLIDE	1800	2010	2011	R		
M FXDLS LOW RIDER S ABS	1800	2016	2017	R		
FMD0435	HONDA	S SZX X 8RS	50	1998	2004	F
		S SZX X 8RX	50	1998	2004	F
FMD0436	HONDA	S SZX X 8RS	50	1998	2004	R
		S SZX X 8RX	50	1998	2004	R
FMD0437	YAMAHA	S X-MAX ABS YP RA 125	125	2011	2013	F
		S X-MAX YP R	125	2006	2009	F
		S X-MAX YP R	125	2010	2013	F
		S X-MAX YP R	250	2005	2013	F
		S X-MAX YP R SPORT	250	2011	2012	F
		S X-MAX YP RA ABS	250	2011	2013	F
		S X-MAX 400 RA IRON MAX ABS	400	2016	2019	F
		S X-MAX ABS MOMODESIGN 400 YP RA	400	2014	2016	F
		S X-MAX MOMODESIGN 400 YP R	400	2014	2016	F
		S X-MAX SPORT	400	2017	2018	F
		S X-MAX YP	400	2013	2019	F
		S X-MAX YP ABS	400	2014	2019	F
		M YP MAJESTY	400	2004	2011	F
		M YP MAJESTY ABS	400	2007	2011	F
		S T MAX ABS XP	500	2005	2007	F
		S T MAX XP	500	2004	2007	F
S T MAX IRON MAX	530	2014	2017	F		
S T MAX LUX MAX ABS	530	2016	2017	F		
S T MAX SX SPORT EDITION ABS	530	2018	2019	F		
S T MAX XP	530	2012	2019	F		
S T MAX XP ABS	530	2012	2019	F		
S T MAX XP DX ABS	530	2017	2019	F		
S T MAX XP SX ABS	530	2017	2019	F		
FMD0439	KAWASAKI	S J300	300	2014	2015	F
		S J300 ABS	300	2014	2017	F
		S J300 ABS SPECIAL EDITION	300	2014	2017	F
		S J300 SPECIAL EDITION	300	2014	2015	F
		S DOWNTOWN i	125	2009	2015	F
KYMCO	KYMCO	S DOWNTOWN i E4	125	2016	2018	F



CC FROM TO FRONT / REAR

...FMD0439		S	DOWNTOWN NOODOE i ABS	125	2019		F		
		M	K-XCT	125	2012	2016	F		
		S	DOWNTOWN i	200	2010	2017	F		
		S	AGILITY maxi 300i ABS	300	2015		F		
		S	DOWNTOWN i	300	2009	2015	F		
		S	DOWNTOWN i ABS	300	2016	2018	F		
		M	K-XCT i	300	2012	2012	F		
		M	K-XCT i	300	2013	2017	F		
		M	K-XCT i ABS	300	2014	2016	F		
		S	SUPER DINK	300	2009	2012	F		
		S	X-TOWN ABS	300	2016	2017	F		
		S	DOWNTOWN i ABS	350	2015	2015	F		
		S	DOWNTOWN i ABS E4	350	2016	2019	F		
		S	DOWNTOWN i TCS NOODOE	350	2018	2019	F		
		FMD0440	KYMCO	S	XCITING	250	2005		F
				S	XCITING i	250	2006		F
				S	XCITING I	300	2008		F
S	XCITING I R			300	2008		F		
S	XCITING			500	2005		F		
S	XCITING I			500	2006	2008	F		
S	XCITING I R			500	2007		F		
S	XCITING R			500	2009		F		
FMD0441	SUZUKI	S	BURGMAN FULL CELL		2012	2015	F/R		
		S	BURGMAN UH	125	2007	2013	F/R		
		S	BURGMAN UH RACING	125	2013	2014	F/R		
		S	BURGMAN UH	200	2007	2014	F/R		
FMD0444	YAMAHA	S	X-MAX 400 RA IRON MAX ABS	400	2016	2019	R		
		S	X-MAX ABS MOMODESIGN 400 YP RA	400	2014	2016	R		
		S	X-MAX MOMODESIGN 400 YP R	400	2014	2016	R		
		S	X-MAX SPORT	400	2017	2018	R		
		S	X-MAX YP	400	2013	2019	R		
		S	X-MAX YP ABS	400	2014	2019	R		
		M	YP MAJESTY	400	2004	2011	R		
		M	YP MAJESTY ABS	400	2007	2011	R		
		FMD0445	YAMAHA	S	X-MAX ABS YP RA 125	125	2011	2013	R
				S	X-MAX ABS YP RA 125	125	2014	2017	R
S	X-MAX YP RA ABS			250	2011	2013	R		
S	X-MAX YP RA ABS			250	2014	2016	R		
FMD0446	PEUGEOT SYM	S	TWEET	50	2010		F		
		S	TWEET EVO	50	2014	2015	F		
		S	TWEET RS	50	2013	2017	F/R		
		S	TWEET	125	2010	2017	F/R		
		S	TWEET i	125	2017		F/R		
		S	TWEET PARIS	125	2015	2017	F/R		
		S	TWEET	150	2010	2018	F/R		
		S	TWEET EVO	150	2014	2015	F/R		
		S	JET 4	50	2009	2010	F		
		S	SYMPHONY	50	2009	2009	F		
		S	SYMPHONY S	50	2010		F		
		S	SYMPHONY SR 4T	50	2010	2018	F/R		
		S	JET 4	125	2009	2009	F		
		S	SYMPHONY	125	2009	2018	F		
		S	SYMPHONY DD	125	2009	2009	F		
		S	SYMPHONY S	125	2010	2019	F		
		S	SYMPHONY SR 4T	125	2010	2017	F/R		
S	SYMPHONY	150	2009	2009	F				
S	SYMPHONY S	150	2010	2014	F				
S	SYMPHONY SR	150	2010	2014	F/R				
FMD0447	BENELLI	S	PEPE	50	1999	2004	F		
		S	PEPE LX	100	2002		F		
		S	VELVET	125	1999	2004	F		
		S	VELVET TOURING	125	2002	2003	F		
		S	VELVET	150	1999	2004	F		
		S	VELVET TOURING	150	2002	2003	F		
FMD0448	SUZUKI	M	GSR	600	2006	2008	R		
		M	GSF BANDIT ABS	650	2005	2006	R		
		M	GSF BANDIT S ABS	650	2007	2011	R		
		M	GXS F	650	2008	2012	R		
		M	SFV GLADIUS	650	2009	2012	R		
		M	SV ABS	650	2003	2012	R		
		M	GSR	750	2011	2012	R		
		M	GSF BANDIT	1200	2006	2006	R		
		M	GSF S BANDIT	1200	2006	2006	R		
		M	GSF BANDIT	1250	2007	2012	R		
		M	GXS FA	1250	2010	2012	R		
		FMD0449	TRIUMPH	M	BONNEVILLE AMERICA (carb)	790	2002	2004	R
				M	SPEEDMASTER (carb)	790	2003	2004	R
M	AMERICA (carb)			865	2005	2011	R		



CC FROM TO FRONT / REAR

FMD0450	BMW	M	AMERICA EFI	865	2012	2015	R
		M	SPEEDMASTER (carb)	865	2005	2010	R
		M	SPEEDMASTER EFI	865	2011	2015	R
		M	ADVENTURER	885	1996	2001	R
		M	LEGEND TT	885	1999	2001	R
		M	THUNDERBIRD	885	1995	2003	R
		M	THUNDERBIRD SPORT	885	1996	2004	R
		M	F 850 GS	850	2018		F
		M	F 850 GS Adventure	850	2019		F
		M	R 850 C	850	1998	2001	F
		M	R 850 GS	850	1998	2007	F
M	F 750 GS	853	2018		F		
M	R 1100 GS	1100	1994	2001	F		
M	R 1100 S	1100	1998	2000	F		
M	R 1150 GS	1150	1999	2001	F		
M	R 1150 GS (Brembo caliper)	1150	2002	2004	F		
M	R 1150 GS ADVENTURE	1150	2002	2005	F		
M	HP2	1200	2006	2009	F		
M	K 1200 LT	1200	1999	2000	F		
M	K 1200 RS	1200	1997	2000	F		
M	R 1200 C	1200	1997	2001	F		
M	R 1200 C CLASSIC	1200	2003		F		
M	R 1200 CL	1200	2002	2006	F		
M	R 1200 GS (R12)	1200	2004	2012	F		
M	R 1200 GS ABS	1200	2004	2012	F		
M	R 1200 GS ABS (K50)	1200	2013	2018	F		
M	R 1200 GS ADVENTURE	1200	2006	2013	F		
M	R 1200 GS ADVENTURE ABS (K51)	1200	2014	2018	F		
M	R 1200 GS Exclusive	1200	2017	2018	F		
M	R 1200 GS RALLYE	1200	2017	2018	F		
M	R 1250 GS	1254	2019		F		
M	R 1250 GS ADVENTURE	1254	2019		F		
M	R 1250 R	1254	2019		F		
M	R 1250 RS	1254	2019		F		
M	R 1250 RT	1254	2019		F		
FMD0451	YAMAHA	S	T MAX IRON MAX	530	2014	2017	R
		S	T MAX LUX MAX ABS	530	2016	2017	R
		S	T MAX SX SPORT EDITION ABS	530	2018	2019	R
		S	T MAX XP	530	2012	2019	R
		S	T MAX XP ABS	530	2012	2019	R
		S	T MAX XP DX ABS	530	2017	2019	R
FMD0452	KYMCO	S	LIKE 2T (Rear Drum Model)	50	2009	2016	F
		S	LIKE 4T (Rear Drum Model)	50	2009	2016	F
		S	LIKE	125	2009	2018	F
		S	LIKE LX	125	2012		F
		S	LIKE 200	200	2009	2016	F
FMD0453	KYMCO	S	G DINK	125	2012	2016	R
		S	LIKE	125	2009	2018	R
		S	LIKE LX	125	2012		R
		S	PEOPLE ONE	125	2015	2019	R
		S	LIKE 200	200	2009	2016	R
FMD0454	YAMAHA	S	G DINK	300	2012	2016	R
		S	XENTER (Rear Drum Model)	125	2012	2016	F
		S	XENTER (Rear Drum Model)	150	2012	2016	F
FMD0456	KAWASAKI	M	KX	125	2006	2008	F
		M	KX	250	2006	2008	F
		M	KX F	250	2006	2014	F
		M	KX F	450	2006	2014	F
FMD0457	YAMAHA	M	YZ	125	2008	2016	F
		M	YZ	250	2008	2016	F
		M	YZ F	250	2007	2015	F
		M	YZ-F	450	2008	2015	F
FMD0459	BETA	M	RR 250	250	2013		R
		M	RR 2T ENDURO 250	250	2014		R
		M	RR 2T ENDURO 300	300	2013		R
		M	RR 4T ENDURO 350	350	2013		R
		M	RR 4T ENDURO 390	390	2015		R
		M	RR 4T ENDURO 400	400	2013	2014	R
		M	RR 4T ENDURO 430	430	2015		R
		M	RR 4T ENDURO 450	450	2013	2015	R
		M	RR CROSS 450	450	2013	2014	R
		M	RR 4T ENDURO 480	480	2015		R
M	RR 4T ENDURO 498	498	2012	2014	R		
FMD0459	KTM	M	RR 4T FACTORY 498	498	2012		R
		M	ENDURO	690	2008	2010	R
		M	ENDURO R	690	2008	2013	R
M	LC8 ADVENTURE	950	2002	2006	R		

M = MOTORCYCLE
S = SCOOTER
A = ATV
Sn = SNOWMOBILE

FERODO
RACING
Updated on November 2020

13025



CC FROM TO FRONT / REAR

Code	Brand	Model	Year	Front	Rear
...FMD0459		M LC8 ADVENTURE S	950 2004 2006	R	
		M SUPER ENDURO R	950 2006 2008	R	
		M LC8 ADVENTURE	990 2006 2008	R	
		M LC8 ADVENTURE R	990 2010 2012	R	
		M LC8 ADVENTURE S	990 2006 2008	R	
FMD0460	HONDA	M CRF R	250 2015	F	
		M CRF 450 L	450 2019	F	
		M CRF R	450 2015	F	
		M CRF RX	450 2017	F	
		M CRF RX Enduro	450 2017	F	
FMD0461	KAWASAKI	M KX F	250 2015	F	
		M KX F	450 2015	F	
FMD0462	YAMAHA	M YZ	125 2017	F	
		M YZ F	250 2016	F	
		M YZ FX	250 2016	F	
		M YZ X	250 2016	F	
		M WR F	450 2016	F	
		M YZ-F	450 2016	F	
FMD0463	HONDA	S NSC AC / C / R / R REPSOL	50 2011 2016	F	
		S NSC VISION CBS	50 2017 2018	F	
		S VISION / VISION CBS	50 2011 2018	F	
		S BEAT CW / FI CW / SW	110 2012	F	
		S SCOOPY	110 2012	F	
		S SPACY	110 2012	F	
		S SPACY HELM / VARIO CW	110 2012	F	
		S VISION / CBS or NCS 16	110 2011 2018	F	
		S WAVE 125 i	110 2011 2017	F	
		M NSX - X-TREME	125 2013 2017	F	
		S PCX CBS	125 2010 2017	F	
		S SH Mode (tamburo post/rear drum)	125 2013 2019	F	
		S VARIO TECHNO / CBS	125 2012	F	
		S PCX / PCX CBS	150 2010 2017	F	
FMD0464	HONDA	M CBF ABS	500 2004 2008	R	
		M CB F HORNET	600 2007 2014	R	
		M CBF	600 2003 2007	R	
		M CBF N	600 2004 2007	R	
		M CBF N	600 2008 2011	R	
		M CBR 600 FA	600 2011 2013	R	
		S X-ADV ABS	745 2017	R	
		S X-ADV DESERT TRACK ABS	745 2019	R	
		S X-ADV X-END ABS	745 2018 2018	R	
		M CBF	1000 2006 2011	R	
		M CBF F	1000 2009 2013	R	
		M CBF ST	1000 2010 2013	R	
		FMD0465	KYMCO	S AGILITY R16 PLUS CBS	125 2017 2019
S PEOPLE S 125 4T (4V)	125 2017			R	
S YAGER GTI	125 2015 2016			R	
S AGILITY i R16 PLUS ABS	150 2018 2019			R	
S PEOPLE S 150 4T (4V)	150 2017			R	
S YAGER GTI	300 2015 2017			R	
FMD0466	KAWASAKI	M Z 750	750 2007 2012	R	
		M Z 750 R	750 2011 2014	R	
		M Z 750 R - ABS	750 2011 2014	R	
		M Z 800	800 2013 2017	R	
		M Z 800 ABS	800 2013 2017	R	
		M Z 800 Sugomi Ed.	800 2016 2016	R	
		M Z 800e	800 2013 2017	R	
		M Z 800e ABS	800 2013 2017	R	
		M Z 900 (ZR900D)	948 2016 2017	R	
		M VERSYS	1000 2012 2015	R	
		M VERSYS ABS	1000 2015 2019	R	
		M VERSYS GRAND TOURER ABS	1000 2016 2018	R	
		M Z 1000	1000 2007 2014	R	
		M Z 1000	1000 2015 2017	R	
		M Z 1000 - ABS	1000 2007 2014	R	
		M Z 1000 - ABS	1000 2015 2019	R	
		M Z 1000 R EDITION ABS (Brembo caliper)	1000 2017 2019	R	
		M Z 1000 SX	1000 2011 2016	R	
		M Z 1000 SX	1000 2017 2019	R	
		M Z 1000 SX ABS	1000 2011 2019	R	
		M Z 1000 SX TOURER	1000 2017	R	
		M Z1000 Sugomi Ed.	1000 2015 2016	R	
		M ZZR	1400 2006 2016	R	
		M ZZR ABS	1400 2006 2018	R	
M ZZR ABS Performance Sport	1400 2016 2018	R			
FMD0467	HONDA	M CBR RR ABS	250 2017	R	
		M CBR RR ABS	300 2017 2018	R	
		M CB 500 F (PC45)	471 2012 2016	R	



CC FROM TO FRONT / REAR

Code	Brand	Model	Year	Front	Rear		
FMD0468	DUCATI	M Hyperstrada 939	937 2016	R			
		M Supersport S	937 2017	R			
		M Panigale V4	1103 2018	R			
		M 1199 Panigale	1198 2012	R			
		M 1199 Panigale R	1198 2013 2017	R			
		M 1199 Panigale S	1198 2012	R			
		M 1199 Panigale S Tricolore	1198 2012 2014	R			
		M Monster 1200	1198 2014	R			
		M Monster 1200 R	1198 2016	R			
		M Multistrada 1200 S Granturismo	1198 2013	R			
FMD0469	HONDA	M CRF 1000 L Africa Twin	998 2015	R			
		M CRF 1000 L Africa Twin Adventure Sport	998 2018	R			
		M CRF 1000 L Africa Twin Rally	998 2018 2018	R			
		M CRF 1000 L Africa Twin Travel Edition	998 2016	R			
		FMD0470	YAMAHA	M Tracer 700	689 2016	R	
				M Tracer 700 ABS	689 2018	R	
				M MT-07	700 2013	R	
				M MT-07 Motocage ABS	700 2015	R	
				M MT-07 Sport	700 2017	R	
				M XSR 700 Xtribute	700 2019	R	
M TRACER 900 GT	847 2018 2019			R			
M MT-09	850 2014 2019			R			
M MT-09 ABS	850 2014 2019			R			
M MT-09 SP ABS	850 2018 2019			R			
FMD0471	HONDA	M CTX 700 (RC69)	670 2013 2018	R			
		M CTX 700 N (RC68)	670 2013 2017	R			
		S NC 700 D Integra (RC62)	670 2012 2014	R			
		M NC 700 S (RC61)	670 2012 2014	R			
		S NC 750 D Integra (RC71)	745 2013 2015	R			
		S NC 750 D Integra (RC89)	745 2015 2018	R			
		M NC 750 S (RC70)	745 2013 2015	R			
		M NC 750 X (RC90)	745 2016	R			
		FMD0472	HUSQVARNA	M 401 Svartpilen	375 2017	R	
				M 401 Vitpilen	375 2017	R	
M 125 Duke	125 2011 2012			R			
M 125 Duke ABS	125 2013 2016			R			
M 125 Duke ABS	125 2017			R			
M 125 RC	125 2014			R			
M 200 Duke ABS	200 2012			R			
M 250 Duke	249 2015			R			
M 250 RC	249 2015			R			
M 390 RC	373 2014			R			
FMD0473	BMW	M R 1200 GS ABS (K50)	1200 2013 2018	R			
		M R 1200 GS ADVENTURE ABS (K51)	1200 2014 2018	R			
		M R 1200 GS Exclusive	1200 2017 2018	R			
		M R 1200 GS RALLYE	1200 2017 2018	R			
		M R 1200 RS	1200 2015 2018	R			
		M R 1200 RT	1200 2014 2018	R			
		M R 1250 GS	1254 2019	R			
		M R 1250 GS ADVENTURE	1254 2019	R			
		M R 1250 R	1254 2019	R			
		M R 1250 RS	1254 2019	R			
FMD0474	YAMAHA	S CYGNUS X	125 2008 2017	F			
		S CYGNUS XC	125 2007	F			

13026

FERODO
RACING
Updated on November 2020

M = MOTORCYCLE
S = SCOOTER
A = ATV
Sn = SNOWMOBILE



DISCS XREF COMPETITORS TO FERODO



BRAKE DISCS X-REF

COMPETITORS TO FERODO

BRAKING	Ferodo	BRAKING	Ferodo	BRAKING	Ferodo	BRAKING	Ferodo
AP08RI	FMD0005	HD01FI Polish (for RP)	FMD0266	HO24FI	FMD0094	KW18RI	FMD0227
AP08RID	FMD0005	HD01FL (for RF)	FMD0266	HO25FI	FMD0095	KW19RI	FMD0340
AP10FI	FMD0050	HD01FL Polish (for RPF)	FMD0266	HO25RI	FMD0221	KW22RI	FMD0235
AP10FID	FMD0050	HD01RI (for R)	FMD0267	HO25RID	FMD0221	KW30RI	FMD0237
AP11FI	FMD0002	HD01RI Polish (for RP)	FMD0267	HO26FL	FMD0427	KW30RID	FMD0237
AP13FL	FMD0038	HD01RL (for RF)	FMD0267	HO26FLD	FMD0427	KW32RI	FMD0107
AP13RI	FMD0164	HD01RL Polish (for RPF)	FMD0267	HO31RI	FMD0096	KW34RI	FMD0238
AP16FI	FMD0003	HD03FLD	FMD0085	HO32FI	FMD0097	KW34RID	FMD0238
AP21RI	FMD0327	HD03RLD	FMD0211	HO33FI	FMD0098	KW35RI	FMD0239
AP22RI	FMD0406	HD05FL	FMD0391	HO33RI	FMD0403	KW36RI	FMD0341
BL01RI	FMD0205	HD05FLD	FMD0266	HO34FI	FMD0435	KW36RID	FMD0341
BM01FI	FMD0353	HD05RLD	FMD0267	HO34RI	FMD0436	MA01FI	FMD0042
BW01FI	FMD0080	HD07FLD	FMD0085	HO40RI	FMD0355	MA03FI	FMD0046
BW02FI	FMD0081	HD09FLD	FMD0266	HO40RID	FMD0355	MA04FI	FMD0048
BW03RI	FMD0075	HD12FI	FMD0338	HO41FI	FMD0270	MB03FI	FMD0110
BW03RID	FMD0075	HD12RL	FMD0339	HO49FI	FMD0057	MB04FID	FMD0319
BW04FI	FMD0082	HD292R (for RP)	FMD0085	HO50FI (Old)	FMD0425	MB04RI	FMD0320
BW04FID	FMD0450	HD292RFL (for RPF)	FMD0085	HO50RID	FMD0014	Old part number: HO38RI	FMD0197
BW05RI	FMD0207	HD292S (for RP)	FMD0211	HO51RID	FMD0409	Old Part Number: YA29RI	FMD0263
BW05RID	FMD0207	HD292SFL (for RPF)	FMD0211	HO60RI	FMD0197	PE01FI	FMD0002
BW06FI	FMD0083	HDF (for R)	FMD0085	HO60RID	FMD0197	PE01FID	FMD0002
BW06RI	FMD0407	HDFFL (for RF)	FMD0085	HU02RI	FMD0179	PE02FI	FMD0025
BW06RID	FMD0407	HDR (for R)	FMD0211	HU03FL	FMD0225	PE03FI	FMD0229
BY101L	FMD0450	HDRFL (for RF)	FMD0211	HU04RI	FMD0190	PI01FI	FMD0022
BY101R	FMD0450	HO01RI	FMD0185	HU07RI	FMD0335	PI01FID	FMD0039
BY105L	FMD0394	HO02RI	FMD0212	IT01FI	FMD0019	PI03FI	FMD0054
BY105R	FMD0394	HO03FI	FMD0087	KM01FI	FMD0034	PI04FI	FMD0055
BY701L	FMD0412	HO03RI	FMD0011	KM05FI	FMD0440	PI04FID	FMD0055
BY701R	FMD0412	HO04FI	FMD0088	KT01FI	FMD0278	RF3104	FMD0430
BY711L	FMD0394	HO05FI	FMD0089	KT02FID	FMD0017	RF3105	FMD0431
BY711R	FMD0394	HO05RI	FMD0009	KT03FL	FMD0279	RF3504	FMD0433
BY747L	FMD0140	HO06RI	FMD0214	KT03FLD	FMD0279	RF7526	FMD0170
BY747R	FMD0140	HO09FI	FMD0015	KT03RI (old)	FMD0184	RF7531	FMD0464
BY770L	FMD0350	HO09FID	FMD0015	KT06FI	FMD0100	RF7533	FMD0409
BY770R	FMD0350	HO09RI	FMD0090	KT06RI	FMD0228	RF7535	FMD0448
BY773L	FMD0352	HO09RID	FMD0090	KT07FI	FMD0399	RF7542	FMD0367
BY773R	FMD0352	HO10FI	FMD0032	KT07RI	FMD0400	RF7549	FMD0470
BY778L	FMD0394	HO12RI	FMD0214	KT08FLD	FMD0279	RF8114	FMD0425
BY778R	FMD0394	HO13FI	FMD0091	KT10RI	FMD0459	RF8116	FMD0437
BY790L	FMD0410	HO13RI	FMD0216	KT10RID	FMD0459	RF8117	FMD0323
BY790R	FMD0410	HO13RID	FMD0216	KT11RI	FMD0184	RF8118	FMD0409
BY798L	FMD0411	HO14FI	FMD0013	KT11RID	FMD0184	RF8119	FMD0043
BY798R	FMD0411	HO15RI	FMD0217	KW01RI	FMD0195	RF8122	FMD0424
DC02RI	FMD0180	HO17FI	FMD0006	KW02FI	FMD0101	RF8123	FMD0324
DC02RID	FMD0180	HO18FI	FMD0033	KW02RI	FMD0230	RF8124	FMD0441
DC04RI	FMD0389	HO18FID	FMD0033	KW03RI	FMD0020	RF8126	FMD0326
DC04RID	FMD0389	HO18RI	FMD0059	KW05FI	FMD0103	RF8127	FMD0398
DC05RI	FMD0390	HO20FI	FMD0271	KW07FI	FMD0218	RF8130	FMD0458
DC05RID	FMD0390	HO21FI	FMD0012	KW07RI	FMD0104	RF8132	FMD0452
GL01RI	FMD0053	HO21FID	FMD0409	KW09RI	FMD0199	RF8134	FMD0463
GL01RID	FMD0053	HO22FI	FMD0010	KW13FI	FMD0105	RF8135	FMD0023
GL06FI	FMD0007	HO22RI	FMD0014	KW13FID	FMD0105	RF8135	FMD0178
GL06FID	FMD0007	HO22RID	FMD0014	KW15RI	FMD0233	RF8138	FMD0420
GL06RI	FMD0210	HO23FI	FMD0093	KW15RID	FMD0233	RF8141	FMD0454
GL06RID	FMD0210	HO23RI	FMD0220	KW16RI	FMD0234	RF8142	FMD0446
HD01FI (for R)	FMD0266			KW18FI	FMD0106	RF8153S	FMD0323

BRAKE DISCS X-REF

COMPETITORS TO FERODO

BRAKING	Ferodo	BRAKING	Ferodo	BRAKING	Ferodo	BRAKING	Ferodo
RF8503	FMD0155	STX69	FMD0349	WF8117	FMD0458	WK070R	FMD0350
RF8505	FMD0009	STX70	FMD0350	WF8501	FMD0155	WK071L	FMD0281
RF8506	FMD0079	STX71	FMD0281	WF8502	FMD0419	WK071R	FMD0281
RF8509	FMD0156	STX73	FMD0352	WF8503	FMD0418	WK073L	FMD0352
RF8511	FMD0171	STX76	FMD0393	WH7003	FMD0450	WK073R	FMD0352
RF8512	FMD0451	STX78	FMD0394	WH7004	FMD0083	WK076L	FMD0393
RF8513	FMD0203	STX90	FMD0410	WK001L	FMD0111	WK076R	FMD0393
RF8514	FMD0453	STX91	FMD0401	WK001R	FMD0111	WK078L	FMD0394
RF8516	FMD0419	STX98	FMD0411	WK004L	FMD0112	WK078R	FMD0394
RF8517	FMD0418	SZ01FI (for R)	FMD0028	WK004R	FMD0112	WK090L	FMD0410
RH7003	FMD0450	SZ01RI	FMD0186	WK005L	FMD0113	WK090R	FMD0410
RH7004	FMD0083	SZ02FI	FMD0027	WK005R	FMD0113	WK098L	FMD0411
RL3005	FMD0430	SZ04FI	FMD0148	WK006L	FMD0114	WK098R	FMD0411
RL3007	FMD0433	SZ04RI	FMD0187	WK006R	FMD0114	WK101L	FMD0412
RL7005	FMD0206	SZ05FI	FMD0208	WK008L	FMD0008	WK101R	FMD0412
RL8002	FMD0437	SZ05RI	FMD0242	WK008R	FMD0008	WK106L	FMD0266
S34012	FMD0017	SZ06FL	FMD0149	WK009L	FMD0116	WK106R	FMD0266
S38007	FMD0323	SZ08RI	FMD0244	WK009R	FMD0116	WK107R	FMD0111
S38009	FMD0055	SZ08RID	FMD0244	WK010L	FMD0117	WK111L	FMD0394
S38010	FMD0026	SZ10RI	FMD0245	WK010R	FMD0117	WK111R	FMD0394
S38012	FMD0334	SZ14RI	FMD0246	WK012L	FMD0119	WK114L	FMD0352
SH01FLD	FMD0330	SZ16FI	FMD0357	WK012R	FMD0119	WK114R	FMD0352
SH01RI	FMD0335	SZ16FID	FMD0357	WK020L	FMD0125	WK125L	FMD0120
STX01	FMD0111	SZ20FL	FMD0150	WK020R	FMD0125	WK125R	FMD0120
STX04	FMD0112	SZ20RI	FMD0247	WK021L	FMD0126	WK139L	FMD0350
STX05	FMD0113	SZ21RI	FMD0248	WK021R	FMD0126	WK139R	FMD0350
STX06	FMD0114	SZ21RID	FMD0248	WK030L	FMD0128	WL4005	FMD0018
STX08	FMD0115	SZ22RI	FMD0249	WK030R	FMD0128	WL8002R	FMD0439
STX09	FMD0116	SZ22RID	FMD0249	WK031L	FMD0224	YA01FI	FMD0037
STX10	FMD0117	SZ24FI	FMD0026	WK031R	FMD0224	YA01RI	FMD0182
STX101	FMD0412	SZ24RI	FMD0250	WK033L	FMD0129	YA01RID	FMD0182
STX11	FMD0118	SZ26FI	FMD0151	WK033R	FMD0129	YA02F	FMD0155
STX12	FMD0119	SZ26RI	FMD0251	WK036L	FMD0130	YA02FI	FMD0031
STX125	FMD0120	SZ32FI	FMD0334	WK036R	FMD0130	YA02RI	FMD0256
STX13	FMD0120	SZ33RI	FMD0079	WK039L	FMD0132	YA03FI	FMD0030
STX15	FMD0121	SZ33RID	FMD0079	WK039R	FMD0132	YA03FID	FMD0030
STX17	FMD0123	SZ35RID	FMD0362	WK040L	FMD0134	YA03RI	FMD0257
STX20	FMD0125	SZ37FI	FMD0396	WK040R	FMD0134	YA05FI	FMD0163
STX21	FMD0126	SZ37RI	FMD0366	WK041L	FMD0135	YA05FID	FMD0163
STX30	FMD0128	SZ38RI	FMD0342	WK041R	FMD0135	YA06FI	FMD0029
STX31	FMD0224	SZ41RID	FMD0448	WK043L	FMD0137	YA06FID	FMD0029
STX33	FMD0129	SZ42RI	FMD0421	WK043R	FMD0137	YA08RI	FMD0023
STX36	FMD0130	SZ42RID	FMD0421	WK046L	FMD0139	YA08RID	FMD0023
STX38	FMD0131	TM03FL	FMD0152	WK046R	FMD0139	YA09RI	FMD0155
STX39	FMD0132	TM03RI	FMD0252	WK047L	FMD0140	YA10FI	FMD0157
STX40	FMD0134	WF4504	FMD0059	WK047R	FMD0140	YA10RI	FMD0258
STX41	FMD0135	WF4505	FMD0184	WK054L	FMD0143	YA12FI	FMD0001
STX42	FMD0136	WF7102	FMD0087	WK061L	FMD0146	YA17FI	FMD0175
STX43	FMD0137	WF7507	FMD0267	WK061R	FMD0146	YA18FI	FMD0159
STX46	FMD0139	WF7526	FMD0470	WK062L	FMD0147	YA19FI	FMD0160
STX47	FMD0140	WF8101	FMD0420	WK062R	FMD0147	YA21FL	FMD0126
STX48	FMD0343	WF8102	FMD0416	WK067L	FMD0241	YA21FL	FMD0275
STX54	FMD0143	WF8103	FMD0043	WK067R	FMD0241	YA22FI	FMD0162
STX61	FMD0146	WF8105	FMD0424	WK069L	FMD0349	YA22RI	FMD0259
STX62	FMD0147	WF8106	FMD0398	WK069R	FMD0349	YA23RI	FMD0260
STX67	FMD0241	WF8112	FMD0452	WK070L	FMD0350	YA24RI	FMD0261

BRAKE DISCS X-REF

COMPETITORS TO FERODO

BRAKING	Ferodo	EBC	Ferodo	EBC	Ferodo	JT BRAKING	Ferodo
YA24RID	FMD0261	MD4013	FMD0199	MD6199D	FMD0143	4061SC01	FMD0258
YA30FI	FMD0273	MD4014	FMD0235	MD651	FMD0207	4062SC01	FMD0263
YA30FID	FMD0273	MD4015	FMD0230	MD653	FMD0075	4080SC01	FMD0157
YA30RI	FMD0274	MD4016LS/RS	FMD0218	MD901	FMD0002	4103SC01	FMD0028
YA30RID	FMD0274	MD4017	FMD0101	MD904D	FMD0001	6002SC01	FMD0399
YA32FID	FMD0023	MD4022LS/RS	FMD0116	MD906D	FMD0006	6003SC01	FMD0400
YA32FID	FMD0178	MD4136LS/RS	FMD0115	MD907D	FMD0110	6025SC01	FMD0184
YA34RI	FMD0265	MD506LS/RS	FMD0085	MD9102D	FMD0437	6026SC01	FMD0017
YA43RI	FMD0360	MD509SR	FMD0211	MD910D	FMD0022		
YA43RID	FMD0360	MD518	FMD0430	MD918D	FMD0013	NEWFREN	Ferodo
YA44RI	FMD0405	MD6001D	FMD0015	MD920D	FMD0435	DF4001 A	FMD0002
YA48RI	FMD0444	MD6002D	FMD0212	MD921D	FMD0436	DF4002 A	FMD0039
YA52RI	FMD0263	MD6010	FMD0087	MD922	FMD0425	DF4004 A	FMD0001
		MD6011D	FMD0182	MD924D	FMD0007	DF4005 A	FMD0040
		MD6013D	FMD0011	MD925D	FMD0025	DF4006 A	FMD0006
BREMBO	Ferodo	MD6013D	FMD0090	MD927D	FMD0260	DF4009 A	FMD0042
08.4899.93	FMD0147	MD6014D	FMD0186	MD930D	FMD0026	DF4012 A	FMD0022
68.B407.97	FMD0203	MD6017D	FMD0028	MD930D	FMD0250	DF4013 A	FMD0210
68.B407.E7	FMD0458	MD6017D	FMD0208	MD932	FMD0210	DF4014 A	FMD0043
68.B407.F0	FMD0459	MD6018D	FMD0151	MD941D	FMD0019	DF4015 A	FMD0007
		MD6024D	FMD0195	MD943	FMD0002	DF4016 A	FMD0166
EBC	Ferodo	MD6025D	FMD0251	MD945D	FMD0003	DF4017 A	FMD0003
MD 1001LS/RS	FMD0010	MD6026D	FMD0106	MD966D	FMD0005	DF4018 A	FMD0044
MD1001	FMD0096	MD6028D	FMD0157			DF4020 A	FMD0013
MD1003LS/RS	FMD0112	MD6037D	FMD0095	GALFER	Ferodo	DF4021 A	FMD0045
MD1004	FMD0014	MD6038D	FMD0242	DF018	FMD0006	DF4022 A	FMD0026
MD1006	FMD0012	MD6039D	FMD0029	DF450	FMD0037	DF4023 A	FMD0023
MD1007	FMD0220	MD6044D	FMD0088	DF470	FMD0175	DF4023 A	FMD0178
MD1008LS/RS	FMD0093	MD6058D	FMD0094	DF495	FMD0139	DF4024 A	FMD0250
MD1010LS/RS	FMD0123	MD605LS/RS	FMD0081	DF629	FMD0002	DF4025 A	FMD0034
MD1014LS/RS	FMD0113	MD606LS/RS	FMD0080	DF814W	FMD0017	DF4026 A	FMD0110
MD1014LS/RS	FMD0134	MD6070D	FMD0031			DF4027 A	FMD0260
MD1126LS/RS	FMD0098	MD6070D	FMD0155	JT BRAKING	Ferodo	DF4028 A	FMD0019
MD1134LS/RS	FMD0128	MD6072D	FMD0256	1009SC01	FMD0214	DF4029 A	FMD0046
MD1138LS/RS	FMD0135	MD6076D	FMD0148	1010SC01	FMD0094	DF4030 A	FMD0047
MD2001LS/RS	FMD0121	MD6077D	FMD0187	1115SC01	FMD0197	DF4033 A	FMD0048
MD2002	FMD0023	MD6077D	FMD0187	1116SC01	FMD0095	DF4034 A	FMD0008
MD2003LS/RS	FMD0352	MD607LS/RS	FMD0206	1117SC01	FMD0212	DF4035 A	FMD0170
MD2011LS/RS	FMD0155	MD6080D	FMD0103	1118SC01	FMD0221	DF4036 A	FMD0049
MD2031LS - MD2078	FMD0160	MD6082D	FMD0234	2000SC01	FMD0107	DF4037 A	FMD0004
MD2068LS/RS	FMD0163	MD6087D	FMD0091	2001SC01	FMD0107	DF4037 A	FMD0171
MD2074LS/RS	FMD0126	MD6093D	FMD0105	2002SC01	FMD0106	DF4038 A	FMD0050
MD2084	FMD0265	MD6094D	FMD0149	2005SC01	FMD0106	DF4039 A	FMD0051
MD3002	FMD0246	MD6102D/DR	FMD0033	2006SC01	FMD0227	DF4040 A	FMD0172
MD3003LS/RS	FMD0120	MD6103D	FMD0059	2110SC01	FMD0021	DF4041 A	FMD0052
MD3006LS/RS	FMD0119	MD6116D	FMD0175	2112SC01	FMD0195	DF4042 A	FMD0053
MD3007LS/RS	FMD0117	MD6118D	FMD0030	2115SC01	FMD0239	DF4043 A	FMD0025
MD3008	FMD0244	MD6119D	FMD0257	3005SC01	FMD0151	DF4044 A	FMD0229
MD30089LS/RS	FMD0241	MD6124D	FMD0221	3010SC01	FMD0162	DF4045 A	FMD0173
MD3033LS	FMD0150	MD6126D	FMD0179	3011SC01	FMD0342	DF4050 A	FMD0309
MD3045LS/RS	FMD0118	MD6128D	FMD0164	3100SC01	FMD0186	DF4051 A	FMD0310
MD3058LS/RS	FMD0125	MD6129D	FMD0038	3105SC01	FMD0028	DF4052 A	FMD0311
MD3059	FMD0245	MD614LS/RS	FMD0111	3110SC01	FMD0248	DF4053 A	FMD0312
MD3060	FMD0249	MD6157D	FMD0248	3200SC01	FMD0396	DF4054 A	FMD0313
MD3061	FMD0247	MD6168D	FMD0089	3210SC01	FMD0366	DF4055 A	FMD0054
MD4006LS/RS	FMD0020	MD6182D	FMD0159	4010SC01	FMD0259	DF4056 A	FMD0055
MD4012LS/RS	FMD0114	MD6191D	FMD0197				

BRAKE DISCS X-REF

COMPETITORS TO FERODO

NEWFREN	Ferodo	NEWFREN	Ferodo	NEWFREN	Ferodo	NEWFREN	Ferodo
DF4058 A	FMD0056	DF4122 A	FMD0445	DF5055 A	FMD0095	DF5136	FMD0456
DF4059 A	FMD0057	DF4123 A	FMD0446	DF5056 A	FMD0021	DF5137	FMD0461
DF4060 A	FMD0014	DF4124 A	FMD0447	DF5057 A	FMD0195	DF5139 AF	FMD0137
DF4061 A	FMD0058	DF4125 A	FMD0441	DF5058 A (old)	FMD0012	DF5140 AF	FMD0140
DF4062 A	FMD0435	DF4128 A	FMD0451	DF5059 A	FMD0073	DF5141 AF	FMD0130
DF4063 A	FMD0079	DF4129 A	FMD0454	DF5060 A	FMD0101	DF5142 AF	FMD0401
DF4064 A	FMD0092	DF4131 A	FMD0453	DF5061 A	FMD0074	DF5145 A	FMD0151
DF4065 A	FMD0133	DF4132 A	FMD0452	DF5062 A	FMD0075	DF5146 A	FMD0162
DF4066 A	FMD0097	DF4134 A	FMD0458	DF5063 A	FMD0076	DF5147 A	FMD0107
DF4067 A	FMD0156	DF4135 AF	FMD0439	DF5064 A	FMD0077	DF5148 A	FMD0094
DF4068 A	FMD0271	DF5001 A	FMD0010	DF5065 A	FMD0199	DF5150 A	FMD0214
DF4069 A	FMD0165	DF5002 A	FMD0256	DF5066 A	FMD0244	DF5151 A	FMD0259
DF4070 A	FMD0167	DF5003 A	FMD0059	DF5067 A	FMD0237	DF5152 AF	FMD0111
DF4071 A	FMD0168	DF5004 A	FMD0176	DF5068 A	FMD0078	DF5153	FMD0450
DF4073 A	FMD0315	DF5005 A	FMD0009	DF5069 A	FMD0205	DF5153 A	FMD0082
DF4074 A	FMD0316	DF5006 A	FMD0031	DF5070 A	FMD0015	DF5155 A	FMD0389
DF4075 A	FMD0317	DF5006 A	FMD0155	DF5071 A	FMD0005	DF5156 AF	FMD0281
DF4076 A	FMD0318	DF5007 A	FMD0029	DF5072 A	FMD0203	DF5157 A	FMD0342
DF4077 A	FMD0319	DF5008	FMD0257	DF5073 A	FMD0087	DF5158 A	FMD0399
DF4078 A	FMD0320	DF5008 A	FMD0030	DF5074 A	FMD0261	DF5160 A	FMD0400
DF4079 A	FMD0325	DF5009 A	FMD0090	DF5075 A	FMD0204	DF5162 A	FMD0402
DF4080 A	FMD0323	DF5010 A	FMD0027	DF5078 A	FMD0163	DF5163 A	FMD0403
DF4081 A	FMD0324	DF5011 A	FMD0091	DF5078 AF	FMD0163	DF5164 A	FMD0404
DF4082 A	FMD0326	DF5013 A	FMD0212	DF5079 A	FMD0155	DF5165 AF	FMD0113
DF4083 A	FMD0327	DF5014 A	FMD0023	DF5080 A	FMD0239	DF5166 AF	FMD0394
DF4084 A	FMD0334	DF5015 A	FMD0020	DF5081 A	FMD0018	DF5167 AF	FMD0121
DF4085 A	FMD0361	DF5016 A	FMD0033	DF5087 AF	FMD0143	DF5168 AF	FMD0139
DF4086 A	FMD0362	DF5017 A	FMD0225	DF5090 A	FMD0175	DF5169 A	FMD0265
DF4087 A	FMD0363	DF5018 A	FMD0179	DF5091 A	FMD0037	DF5170 A	FMD0405
DF4088 A	FMD0367	DF5019 A	FMD0180	DF5094 A	FMD0152	DF5171 A	FMD0023
DF4089 A	FMD0437	DF5020 A	FMD0221	DF5095 A	FMD0252	DF5172 AF	FMD0126
DF4089 AF	FMD0437	DF5021 A	FMD0182	DF5103 A	FMD0459	DF5173 A	FMD0246
DF4090 A	FMD0369	DF5022 A	FMD0249	DF5106 A	FMD0328	DF5174 AF	FMD0115
DF4092 A	FMD0371	DF5023 A	FMD0064	DF5107 AF	FMD0279	DF5176 A	FMD0088
DF4098 A	FMD0398	DF5024 A	FMD0184	DF5108 A	FMD0083	DF5177 A	FMD0406
DF4099 A	FMD0397	DF5025 A	FMD0185	DF5109 A	FMD0106	DF5178 A	FMD0407
DF4101 A	FMD0408	DF5026 A	FMD0157	DF5111 A	FMD0331	DF5181 A (for R)	FMD0266
DF4102 A	FMD0413	DF5027 A	FMD0186	DF5112 A	FMD0332	DF5181 AF (for RF)	FMD0266
DF4103 A	FMD0012	DF5028 A	FMD0187	DF5113 A	FMD0333	DF5181 AFL (for RPF)	FMD0266
DF4103 A	FMD0409	DF5029 A	FMD0248	DF5115 A	FMD0330	DF5181 AL (for RP)	FMD0266
DF4104 A	FMD0414	DF5030 A	FMD0258	DF5116 A	FMD0335	DF5182 A (for R)	FMD0267
DF4105 A	FMD0415	DF5031 A	FMD0032	DF5121 A	FMD0366	DF5182 AF (for RF)	FMD0267
DF4106 A	FMD0416	DF5032 A	FMD0208	DF5122	FMD0251	DF5182 AFL (for RPF)	FMD0267
DF4107 A	FMD0417	DF5034 A	FMD0011	DF5122 A	FMD0227	DF5182 AL (for RP)	FMD0267
DF4108 A	FMD0418	DF5036 A	FMD0190	DF5123 A	FMD0396	DF5183 A (for R)	FMD0085
DF4109 A	FMD0419	DF5037 A	FMD0242	DF5125 A	FMD0365	DF5183 AF (for RF)	FMD0085
DF4110 A	FMD0420	DF5038 A	FMD0258	DF5126 A	FMD0375	DF5183 AFL (for RPF)	FMD0085
DF4111 A	FMD0421	DF5040	FMD0462	DF5127 A	FMD0381	DF5183 AL (for RP)	FMD0085
DF4112 AF	FMD0422	DF5041	FMD0457	DF5128 A	FMD0382	DF5184 A (for R)	FMD0211
DF4113 A	FMD0423	DF5041 AF (for RF)	FMD0028	DF5129 A	FMD0093	DF5184 AF (for RF)	FMD0211
DF4114 A	FMD0424	DF5043 A (old)	FMD0184	DF5130 A	FMD0377	DF5184 AFL (for RPF)	FMD0211
DF4115 A	FMD0425	DF5048 AF	FMD0017	DF5131 A	FMD0378	DF5184 AL (for RP)	FMD0211
DF4116 A	FMD0426	DF5049 A	FMD0263	DF5132 AF	FMD0343	DF5186 A	FMD0159
DF4117 AF	FMD0439	DF5051 A (for R)	FMD0028	DF5133 AF	FMD0350	DF5187 AF	FMD0038
DF4118 A	FMD0440	DF5053 A	FMD0216	DF5134 AF	FMD0241	DF5188 AF	FMD0206
DF4121 A	FMD0444	DF5054 A	FMD0197	DF5135 AF	FMD0393	DF5189 A	FMD0207

BRAKE DISCS X-REF

COMPETITORS TO FERODO

NEWFREN	Ferodo	NG	Ferodo	NG	Ferodo	NG	Ferodo
DF5191 A	FMD0096	101X	FMD0014	1098	FMD0355	1236	FMD0132
DF5192 A	FMD0098	101XA	FMD0014	110	FMD0093	1237	FMD0040
DF5193 A	FMD0100	1022	FMD0097	1100	FMD0047	1238	FMD0465
DF5194 A	FMD0228	1022	FMD0414	1102	FMD0094	124	FMD0117
DF5195 A	FMD0103	1023	FMD0409	1103	FMD0365	1247	FMD0267
DF5196 A	FMD0104	1025	FMD0100	1107	FMD0327	1248	FMD0430
DF5197 A	FMD0105	1026	FMD0228	1108	FMD0227	125	FMD0427
DF5198 AF	FMD0112	1029	FMD0399	1108	FMD0251	1255	FMD0146
DF5199 AF	FMD0114	103	FMD0020	110X	FMD0093	1262	FMD0341
DF5201 AF	FMD0117	1030	FMD0400	1115	FMD0098	1264	FMD0335
DF5202 AF	FMD0118	1032	FMD0155	1118	FMD0421	1283	FMD0411
DF5203 AF	FMD0119	1033	FMD0320	112	FMD0271	1289	FMD0134
DF5204 AF	FMD0120	1036	FMD0397	1123	FMD0424	129	FMD0184
DF5206 AF	FMD0125	1040	FMD0334	1124	FMD0320	1293	FMD0017
DF5207 AF	FMD0129	1041	FMD0393	1126	FMD0417	1294X	FMD0459
DF5208 AF	FMD0131	1042	FMD0081	1127	FMD0419	1296	FMD0451
DF5209 AF	FMD0132	1043	FMD0279	113	FMD0043	1296X	FMD0451
DF5210 A	FMD0089	1044	FMD0082	113	FMD0447	130	FMD0039
DF5211 AF	FMD0134	1044	FMD0450	1132	FMD0074	1303	FMD0390
DF5212 AF	FMD0135	1044X	FMD0450	1137	FMD0206	1306	FMD0220
DF5213 AF	FMD0146	1045	FMD0407	1137X	FMD0206	131	FMD0110
DF5214 AF	FMD0147	1045X	FMD0407	1143	FMD0107	1311	FMD0472
DF5215 A	FMD0148	1046	FMD0083	1146	FMD0401	1313	FMD0446
DF5216 A	FMD0164	1047	FMD0080	1147	FMD0406	1313x	FMD0446
DF5217 A	FMD0217	1048	FMD0396	1148	FMD0363	1319	FMD0431
DF5218 A	FMD0218	1049	FMD0197	1154	FMD0095	1330	FMD0427
DF5219 A	FMD0220	1049	FMD0221	1156	FMD0418	1333	FMD0433
DF5220 AF	FMD0224	1049	FMD0366	1157	FMD0416	1335	FMD0458
DF5221 A	FMD0233	1050	FMD0413	1158	FMD0420	1335	FMD0458
DF5222 A	FMD0234	1052	FMD0389	1159	FMD0118	1336	FMD0203
DF5223 A	FMD0238	1054	FMD0444	1164	FMD0018	1340	FMD0471
DF5224 AF	FMD0275	1055	FMD0361	1172	FMD0459	1341	FMD0005
DF5227 A	FMD0341	1056	FMD0350	1172X	FMD0459	1345	FMD0452
DF5229 AF	FMD0349	1056X	FMD0350	1174	FMD0448	1346	FMD0453
DF5230 AF	FMD0352	1057	FMD0184	1179	FMD0474	135	FMD0179
DF5231 A	FMD0390	1058	FMD0281	1180	FMD0123	135	FMD0190
DF5266 A	FMD0449	1060	FMD0111	1182	FMD0238	1358	FMD0394
DF5272 AF	FMD0410	1060	FMD0352	119	FMD0015	1359	FMD0319
DF5275 A	FMD0448	1061	FMD0441	1194	FMD0038	1364	FMD0402
DF5278	FMD0412	1065	FMD0079	1195	FMD0422	137	FMD0021
DF5296	FMD0460	1066	FMD0440	1197	FMD0131	138	FMD0195
		1068	FMD0365	120	FMD0119	139	FMD0278
		107	FMD0097	121	FMD0246	1414	FMD0343
NG	Ferodo	107	FMD0414	1212	FMD0224	1429	FMD0427
10	FMD0316	1071	FMD0053	1213	FMD0410	1434	FMD0473
100	FMD0237	1073	FMD0427	1214	FMD0412	1443	FMD0454
1000	FMD0349	1077	FMD0447	1217	FMD0080	1451	FMD0470
1001	FMD0055	1078	FMD0415	1218	FMD0466	1452	FMD0146
1001	FMD0168	108	FMD0006	1219	FMD0463	147	FMD0171
1003	FMD0357	1081	FMD0367	1220	FMD0411	1485	FMD0467
1004	FMD0211	1083	FMD0437	1222	FMD0439	1486	FMD0460
1008	FMD0326	1090	FMD0398	1222X	FMD0439	1494	FMD0266
101	FMD0014	1093	FMD0323	1225	FMD0199	151	FMD0104
1011	FMD0034	1095	FMD0089	1230	FMD0403	1523	FMD0468
1011	FMD0034	1095	FMD0464	1233	FMD0422	154	FMD0101
1015	FMD0135	1098	FMD0056	1233	FMD0437	155	FMD0435
101A	FMD0014						

BRAKE DISCS X-REF

COMPETITORS TO FERODO

NG	Ferodo	NG	Ferodo	NG	Ferodo	NG	Ferodo
1550	FMD0469	263	FMD0190	441	FMD0315	689	FMD0173
1552	FMD0149	264	FMD0273	45	FMD0212	691	FMD0250
156	FMD0199	276	FMD0028	451	FMD0057	693	FMD0137
1567	FMD0445	28	FMD0023	451	FMD0057	694	FMD0328
158	FMD0049	28	FMD0178	453	FMD0324	7	FMD0002
1581	FMD0095	285	FMD0049	458	FMD0125	706	FMD0190
1581	FMD0396	286	FMD0059	46	FMD0087	706	FMD0204
1586	FMD0197	288	FMD0164	464	FMD0190	707	FMD0046
1586	FMD0221	289	FMD0051	464	FMD0204	71	FMD0055
1586	FMD0366	290	FMD0170	473	FMD0015	715	FMD0332
1592	FMD0050	292	FMD0050	473	FMD0091	716	FMD0110
1606	FMD0466	294	FMD0126	474	FMD0216	717	FMD0371
1612	FMD0244	297	FMD0129	48	FMD0089	718	FMD0180
1634	FMD0367	3	FMD0165	483	FMD0155	719	FMD0028
1636	FMD0244	302	FMD0184	494	FMD0274	719	FMD0157
165	FMD0139	303	FMD0002	51	FMD0027	724	FMD0095
166	FMD0116	306	FMD0229	52	FMD0148	725	FMD0143
1686	FMD0464	312	FMD0217	52	FMD0208	730	FMD0143
17	FMD0003	313	FMD0220	53	FMD0357	735	FMD0266
17	FMD0044	314	FMD0159	54	FMD0031	735	FMD0391
170	FMD0101	316	FMD0064	54	FMD0155	736	FMD0266
1712	FMD0139	317	FMD0331	57	FMD0030	739	FMD0085
176	FMD0025	320	FMD0157	57	FMD0257	740	FMD0085
178	FMD0100	321	FMD0163	59	FMD0256	742	FMD0211
1786	FMD0139	325	FMD0207	601	FMD0436	745	FMD0162
182	FMD0006	326	FMD0164	608	FMD0353	750	FMD0115
183	FMD0166	329	FMD0248	610	FMD0022	751	FMD0128
1830	FMD0043	339	FMD0048	612	FMD0007	752	FMD0113
185	FMD0103	34	FMD0029	626	FMD0064	754	FMD0151
190	FMD0019	351	FMD0172	637	FMD0233	755	FMD0225
193	FMD0310	362	FMD0018	638	FMD0054	756	FMD0106
196	FMD0026	362	FMD0360	639	FMD0261	757	FMD0259
198	FMD0091	364	FMD0008	64	FMD0318	760	FMD0251
200	FMD0091	364	FMD0425	643	FMD0134	761	FMD0185
203	FMD0032	364	FMD0425	644	FMD0130	771	FMD0012
204	FMD0010	365	FMD0007	645	FMD0331	776	FMD0114
204	FMD0088	366	FMD0210	648	FMD0335	779	FMD0260
204	FMD0096	372	FMD0258	65	FMD0187	784	FMD0405
207	FMD0033	375	FMD0221	650	FMD0378	788	FMD0140
209	FMD0009	388	FMD0325	651	FMD0270	789	FMD0263
209	FMD0009	39	FMD0037	654	FMD0197	790	FMD0241
209	FMD0205	390	FMD0029	656	FMD0011	791	FMD0249
209	FMD0426	392	FMD0018	658	FMD0156	792	FMD0012
214	FMD0096	393	FMD0045	66	FMD0095	792	FMD0409
216	FMD0112	395	FMD0275	665	FMD0002	796	FMD0214
227	FMD0167	401	FMD0175	674	FMD0149	799	FMD0239
23	FMD0002	404	FMD0121	675	FMD0028	801	FMD0365
233	FMD0210	405	FMD0257	676	FMD0186	81	FMD0309
236	FMD0075	406	FMD0001	678	FMD0211	84	FMD0013
237	FMD0091	409	FMD0160	679	FMD0266	859	FMD0091
239	FMD0120	41	FMD0217	679	FMD0391	86	FMD0092
240	FMD0244	420	FMD0085	682	FMD0330	868	FMD0310
243	FMD0184	420	FMD0211	683	FMD0335	88	FMD0311
257	FMD0053	422	FMD0182	686	FMD0058	89	FMD0172
259	FMD0333	43	FMD0090	686	FMD0369	9	FMD0190
26	FMD0165	44	FMD0242	687	FMD0218	90	FMD0105

BRAKE DISCS X-REF

COMPETITORS TO FERODO

NG	Ferodo	OEM	Ferodo	OEM	Ferodo	OEM	Ferodo
902	FMD0394	41080 1197	FMD0218	45251 ML7 690	FMD0010	59220 01D21	FMD0119
903	FMD0265	41080 1198	FMD0218	45251 MT2 003	FMD0098	59220 01D30	FMD0119
909	FMD0342	41080 1203	FMD0230	45251 MT8 000	FMD0098	59220 17C00	FMD0117
91	FMD0234	41080 1219 CM	FMD0230	45251 MV9 000	FMD0010	59220 17C01	FMD0117
910	FMD0018	41080 1240 CN	FMD0114	45351 GBM 705	FMD0006	59220 17C31	FMD0117
919	FMD0011	41080 1241 CN	FMD0114	45351 MB0 000	FMD0010	59220 17E00	FMD0117
94	FMD0340	41080 1242 CL	FMD0199	45351 MB0 700	FMD0010	59220 17E10	FMD0117
95	FMD0133	41080 1242 FB	FMD0199	45351 MG5 670	FMD0010	59220 22D00	FMD0118
99	FMD0312	41080 1284 CN	FMD0114	45351 MJ1 670	FMD0010	59220 22D10	FMD0118
		41080 1285 CN	FMD0114	45351 MR5 000	FMD0010	59220 22D40	FMD0118
		41080 1306 CM	FMD0116	45351 MT2 002	FMD0098	59220 31E00	FMD0119
OE BMW	Ferodo	41080 1307 CM	FMD0116	45351 MT2 003	FMD0098	59220 31E10	FMD0119
34 21 8 526 568	FMD0473	41080 1318 CN	FMD0114	45351 MV9 000	FMD0010	59220 32C00	FMD0120
		41080 1318 FF	FMD0114	4BP 2582T 00	FMD0160	59220 32C01	FMD0120
OEM	Ferodo	41080 1319 CN	FMD0114	4DU 2582W 00	FMD0023	59220 32C10	FMD0120
11U 25831 00	FMD0155	41080 1319 FF	FMD0114	4FM 2581T 00	FMD0352	59220 32C11	FMD0120
1KT 25830 01	FMD0352	41080 1351 FF	FMD0116	4FM 2581T 01	FMD0352	59220 32C31	FMD0120
1UA 25831 00	FMD0155	41080 1353 FB	FMD0235	4FM 2582W 00	FMD0023	59220 32C70	FMD0120
1UA 25831 10	FMD0155	41080 1371 FB	FMD0218	4HM 2581T 00	FMD0121	59220 32C80	FMD0120
1UF 25831 00	FMD0155	41080 1408 FF	FMD0116	4HM 2581T 11	FMD0121	59220 40C01	FMD0117
1UF 25831 10	FMD0155	41080 1437 A4	FMD0115	4HM 2582W 00	FMD0023	59220 40C02	FMD0117
28V 25831 00	FMD0155	41080 1463 A4	FMD0115	4KG 2581T 00	FMD0352	59220 40C03	FMD0117
28V 25831 10	FMD0155	41080 1468 A4	FMD0116	4NK 2582W 00	FMD0160	59220 40C10	FMD0117
29L 25831 00	FMD0155	42H 25831 00	FMD0155	4SV 2581T 00	FMD0126	59220 40C11	FMD0117
29L 25831 10	FMD0155	43251 KEA 000	FMD0014	4SV 2582W 00	FMD0023	59220 46D10	FMD0120
29L 25831 20	FMD0155	43251 MCJ 000	FMD0014	51Y 25831 00	FMD0155	59221 45C00	FMD0150
29L 25831 30	FMD0155	43251 MG E01	FMD0220	59210 08F00	FMD0120	59221 45C10	FMD0150
2GH 25830 00	FMD0352	43251 MT4 000	FMD0220	59210 17C00	FMD0117	5EB 2582W 00	FMD0265
2KT 25831 00	FMD0155	43251 MV4 000	FMD0014	59210 17C01	FMD0117	5JJ 2581T 00	FMD0126
2KT 25831 10	FMD0155	45120 KY2 003	FMD0112	59210 17C31	FMD0117	5PX 2581T 00	FMD0126
2NX 25831 00	FMD0023	45120 MAE 000	FMD0112	59210 17E00	FMD0117	69211 01D00	FMD0246
3 HE 2581T 00	FMD0121	45120 MAL 601	FMD0112	59210 17E10	FMD0117	69211 17C00	FMD0244
3CV 25830 00	FMD0121	45120 MAS E01	FMD0128	59210 22D00	FMD0118	69211 17C10	FMD0244
3CV 25830 10	FMD0121	45120 MBG 003	FMD0134	59210 22D10	FMD0118	69211 19C00	FMD0246
3CW 2581T 00	FMD0121	45120 MR7 000	FMD0123	59210 22D40	FMD0118	69211 33E00	FMD0249
3EN 2581T 00	FMD0121	45120 MR7 010	FMD0123	59210 22D80	FMD0118	69211 33E10	FMD0249
3GM 2581T 00	FMD0352	45120 MW0 003	FMD0113	59210 31E00	FMD0119	69211 34C00	FMD0246
3GM 2582W 00	FMD0155	45120 MW0 003	FMD0134	59210 31E10	FMD0119	69211 45C00	FMD0247
3GM 2582W AO	FMD0155	45220 MAE 000	FMD0112	59210 32C00	FMD0120	69211 45C10	FMD0247
3JK 25831 00	FMD0155	45220 MAL 601	FMD0112	59210 32C01	FMD0120		
3JK 25831 10	FMD0155	45220 MAL G01	FMD0112	59210 32C10	FMD0120	OEM - Honda	Ferodo
3JP 2581T 00	FMD0126	45220 MAS E01	FMD0128	59210 32C11	FMD0120	43251-K04-931	FMD0409
3LE 2581T 00	FMD0352	45220 MBG 003	FMD0113	59210 32C31	FMD0120	43251-K04-F01	FMD0009
3LR 2581T 00	FMD0126	45220 MBG 003	FMD0134	59210 32C70	FMD0120	45251-415-611	FMD0073
3RG 2581T 00	FMD0121	45220 MR7 000	FMD0123	59210 32C80	FMD0120	452A5-426-610	FMD0073
3SH F5830 10	FMD0352	45220 MR7 010	FMD0123	59210 33E00	FMD0125	45351 MCT 003	FMD0409
3SX 2582W 00	FMD0023	45220 MR7 010	FMD0123	59210 33E20	FMD0125	45351-KRN-A90	FMD0460
3VD 2582W 00	FMD0023	45220 MZ7 000	FMD0112	59210 33E70	FMD0125		
41080 1107	FMD0218	45251 KM4 000	FMD0012	59210 40C01	FMD0117	OEM - Kawasaki	Ferodo
41080 1108	FMD0101	45251 KT8 000	FMD0010	59210 40C02	FMD0117	41080-0616	FMD0461
41080 1109	FMD0218	45251 MB0 000	FMD0010	59210 40C03	FMD0117		
41080 1112	FMD0218	45251 MB0 700	FMD0010	59210 40C10	FMD0117	OEM - Piaggio	Ferodo
41080 1132	FMD0020	45251 ME5 780	FMD0010	59210 40C11	FMD0117	56484R	FMD0043
41080 1151	FMD0230	45251 MG5 670	FMD0010	59210 46D10	FMD0120		
41080 1154	FMD0218	45251 MJ1 670	FMD0010	59211 48E00	FMD0118	OEM - Suzuki	Ferodo
41080 1155	FMD0218	45251 MK4 600	FMD0010	59220 01D11	FMD0119	B11-2581T-00-00	FMD0462
41080 1181	FMD0218	45251 ML0 000	FMD0012				

BRAKE DISCS X-REF

COMPETITORS TO FERODO

OEM - Yamaha	Ferodo	OEM Ducati	Ferodo	OEM Honda	Ferodo	OEM Kawasaki	Ferodo
1B9F582U0000	FMD0437	49240101A	FMD0147	45120 MR7 000	FMD0123	41080 1255FB	FMD0233
3LD2582W0100	FMD0257	49240111B	FMD0180	45120 MZ1 003	FMD0123	41080 1269	FMD0251
3LD258310000	FMD0030	49240241A	FMD0111	45121 KS4 000	FMD0271	41080 1315	FMD0105
4B52581T0000	FMD0422	49240291A	FMD0111	45220 MBZ C51	FMD0137	41080 1351FF	FMD0116
		49240661A	FMD0147	45220 MBZ D61	FMD0137	41080 1353FB	FMD0235
		49240791A	FMD0147	45220 MEL 003	FMD0140	41080 1368	FMD0340
OEM Aprilia	Ferodo			45220 MFL 003	FMD0411	41080 1437A4	FMD0115
8113485	FMD0038			45220 MZ0 003	FMD0113	41080 1443CL	FMD0237
8113500	FMD0132	OEM Harley	Ferodo	45251 MCB7 71	FMD0087	41080 1461A4	FMD0114
8113541	FMD0003	41666 01	FMD0339	45251 MFE 671	FMD0093	41080 1469CL	FMD0238
8113563	FMD0164	41789 92	FMD0211	45251KPP 901	FMD0010	41080 1492	FMD0227
8113607	FMD0111	41791 79A	FMD0211	45251MET 641	FMD0093	41080 1503FB	FMD0218
8113628	FMD0164	41797 00	FMD0267	45251MT8 000	FMD0098	41080 1529488	FMD0343
8113697	FMD0050	41808-08	FMD0430	45351 GCM 900	FMD0435	K41080 01470000	FMD0107
8113800	FMD0171	41809-08	FMD0430	45351 KFG 003	FMD0425	K41080 1470000	FMD0107
8113926	FMD0352	44136 00	FMD0266	45351 KGF 900	FMD0057		
8213231	FMD0002	44136 84A	FMD0085	45351 KTW 901	FMD0409	OEM KTM	Ferodo
8213381	FMD0003	44136 92	FMD0085	45351 KZ1 771	FMD0015	4GVF582W00	FMD0182
		44156 00	FMD0266	45351 KZ1 771	FMD0091	50309060000	FMD0017
		44343 01	FMD0338	45351 MBA 000	FMD0093	54809060000	FMD0017
OEM Benelli	Ferodo	44553-06A	FMD0431	45351 MBL D61	FMD0093	54809060100	FMD0017
R180271101000	FMD0111			45351 MBN 671	FMD0015	54810060000	FMD0184
R180272105000	FMD0207	OEM Honda	Ferodo	45351 MCT 911	FMD0458	56509060700	FMD0017
		43251 KTW 901	FMD0409	45351 MER D01	FMD0093	58010060600	FMD0184
		43251 MAT 000	FMD0012	45351 MER G01	FMD0093	58309060100	FMD0279
		43251 MBZ G01	FMD0014	45351 MGR 670	FMD0093	58310060100	FMD0184
OEM Beta	Ferodo	43251 MCB 771	FMD0425	45351 MK5 010	FMD0032	58709060000	FMD0143
1339290000	FMD0002	43251 MCN 721	FMD0425	45351 MN9 020	FMD0087		
		43251 MCT 911	FMD0203	45351 MS6 900	FMD0088	OEM Kymco	Ferodo
		43251 MCW D01	FMD0220	45351 MV1 000	FMD0033	00156300	FMD0229
		43251 MCZ 003	FMD0425	45351 MV9 000	FMD0010		
		43251 MEE 000	FMD0014	45351-KEY-901	FMD0425		
		43251 MW3 600	FMD0425			OEM Moto Guzzi	Ferodo
		43251 MW3 600	FMD0425			306133000	FMD0121
		43251 MZ2 000	FMD0012			376133050	FMD0111
		43251 MBL D00	FMD0096	OEM Kawasaki	Ferodo	56133300	FMD0111
		43251 MBL D01	FMD0096	41080 1442A4	FMD0224	GU05613330	FMD0111
		43251 MBL D61	FMD0096	41080 0025FB	FMD0233		
		43351 GCM 900	FMD0436	41080 0037	FMD0237		
		43351 KPC 641	FMD0090	41080 0040	FMD0237	OEM MZ	Ferodo
		43351 KZ1 770	FMD0090	41080 0067488	FMD0350	9017542000	FMD0111
		43351 KZ4 J40	FMD0197	41080 0068488	FMD0350		
		43351 MBT 610	FMD0059	41080 0069FB	FMD0105		
		43351 MS2 000	FMD0096	41080 0070FB	FMD0234	OEM PEUGEOT	Ferodo
		43351 PKC 641	FMD0090	41080 00775C	FMD0350	744573	FMD0025
		45120 MAL G01	FMD0112	41080 007810R	FMD0350		
		45120 MAS E01	FMD0128	41080 0098111	FMD0350	OEM Piaggio	Ferodo
		45120 MAT B91	FMD0131	41080 0103111	FMD0350	56395R	FMD0022
		45120 MBW E11	FMD0134	41080 0104111	FMD0350		
		45120 MBW N31	FMD0134	41080 01106	FMD0104		
		45120 MCF D01	FMD0135	41080 01108	FMD0101	OEM Piaggio/Gilera	Ferodo
		45120 MCJ 831	FMD0130	41080 01112	FMD0218	272156	FMD0002
		45120 MCZ 003	FMD0134	41080 01132	FMD0020	56408R	FMD0002
		45120 MEE 003	FMD0140	41080 01148	FMD0103	666761	FMD0007
		45120 MEE D01	FMD0140	41080 01219CM	FMD0230		
		45120 MFJ D01	FMD0140	41080 01238	FMD0234	OEM Suzuki	Ferodo
		45120 MFL 003	FMD0411	41080 01240CN	FMD0114	59210 08F10	FMD0349
		45120 MFL D01	FMD0411	41080 01242FB	FMD0199	59210 01DA0	FMD0119
						59210 08F00	FMD0120
						59210 18G20	FMD0241

BRAKE DISCS X-REF

COMPETITORS TO FERODO

OEM Suzuki	Ferodo	OEM Yamaha	Ferodo
59210 18G30	FMD0241	36Y 25831 10	FMD0163
59210 22D00	FMD0118	3CW 2582T 00	FMD0121
59210 33E70	FMD0125	3CW2581T0000	FMD0163
59210 37H01 000	FMD0412	3GM 2582W 00	FMD0155
59210 40C03	FMD0117	3GM 2582W A0	FMD0155
59210 40C11	FMD0117	3JB 2582U 01	FMD0275
592103 2C31	FMD0120	3JP 2582T 00	FMD0163
59211 13E00	FMD0028	3JP 2582U 00	FMD0163
59211 44B00	FMD0148	3LD 2582W 00	FMD0030
59220 32C31	FMD0120	3LD 2582W 01	FMD0257
59220 32E00	FMD0149	3SHF582W0000	FMD0182
59220 37F20	FMD0028	3TB 2582T 00	FMD0031
59220 40C10	FMD0117	3TB 2582T 00	FMD0155
59221 02B21	FMD0151	43F 25831 00	FMD0031
59221 13E00	FMD0028	43F 25831 00	FMD0155
59221 14A00	FMD0027	46X 25831 00	FMD0023
59221 14F10	FMD0026	4B5 2582V 00	FMD0155
59221 45C00	FMD0150	4BH2581T0100	FMD0281
69211 01D00	FMD0246	4BP 2582T 00	FMD0160
69211 01DA0	FMD0246	4GV F582T 00	FMD0159
69211 02B41	FMD0342	4HM 2582T 21	FMD0121
69211 03D01	FMD0242	4JH 2582W 00	FMD0023
69211 14F00	FMD0250	4KG 2582T 10	FMD0111
69211 18G00	FMD0249	4SV 2582T 00	FMD0126
69211 21E00	FMD0244	4XM 2582T 00	FMD0157
69211 32C30	FMD0245	55U 25831 00	FMD0029
69211 34C00	FMD0246	5ADF58310000	FMD0002
69211 37F10	FMD0248	5BR F582V 0000	FMD0097
69211 37F20	FMD0248	5CG 2582W 00	FMD0260
69211 40F10	FMD0249	5DH 2582W 00	FMD0258
69211 44B00	FMD0187	5DS F5831 00	FMD0110
69211 45C10	FMD0247	5GM 2582W 00	FMD0173
		5JH F5831 0000	FMD0097
		5KS 2582W 00	FMD0163
OEM Sym	Ferodo	5MF F5831 00	FMD0110
45121 HMB00 0SH	FMD0420	5MV 2582T 00	FMD0028
		5NY 2582W 00	FMD0263
OEM Triumph	Ferodo	5PX 2582T 00	FMD0126
T2020142	FMD0146	5RU 2582T 1000	FMD0437
T2020143	FMD0146	5RU 2582T 3000	FMD0437
T2022501	FMD0146	5SL 2582T 00	FMD0139
T2025200	FMD0014	5SL 2582W 00	FMD0265
		5VU 2581T 0100	FMD0437
OEM Yamaha	Ferodo	5VU 2582W 00	FMD0155
11U 25831 00	FMD0155	5VX 2582T 00	FMD0139
1RC 2581T 00	FMD0139	5VX 2582T 01	FMD0139
1TX 25831 00	FMD0163	5YU 2582T 00	FMD0129
1TX 25831 10	FMD0163	5YU 2582V 00	FMD0155
1UA 25831 00	FMD0155		
23P2581T0000	FMD0394		
29L 25831 00	FMD0155		
29L 25831 10	FMD0155		
29L 25831 30	FMD0155		
2HY 25831 00	FMD0163		
2HY 25831 10	FMD0163		
2KF 25831 50	FMD0256		
36Y 25831 00	FMD0163		

FERODO[®]

CLUTCHES

MOTORCYCLE APPLICATIONS

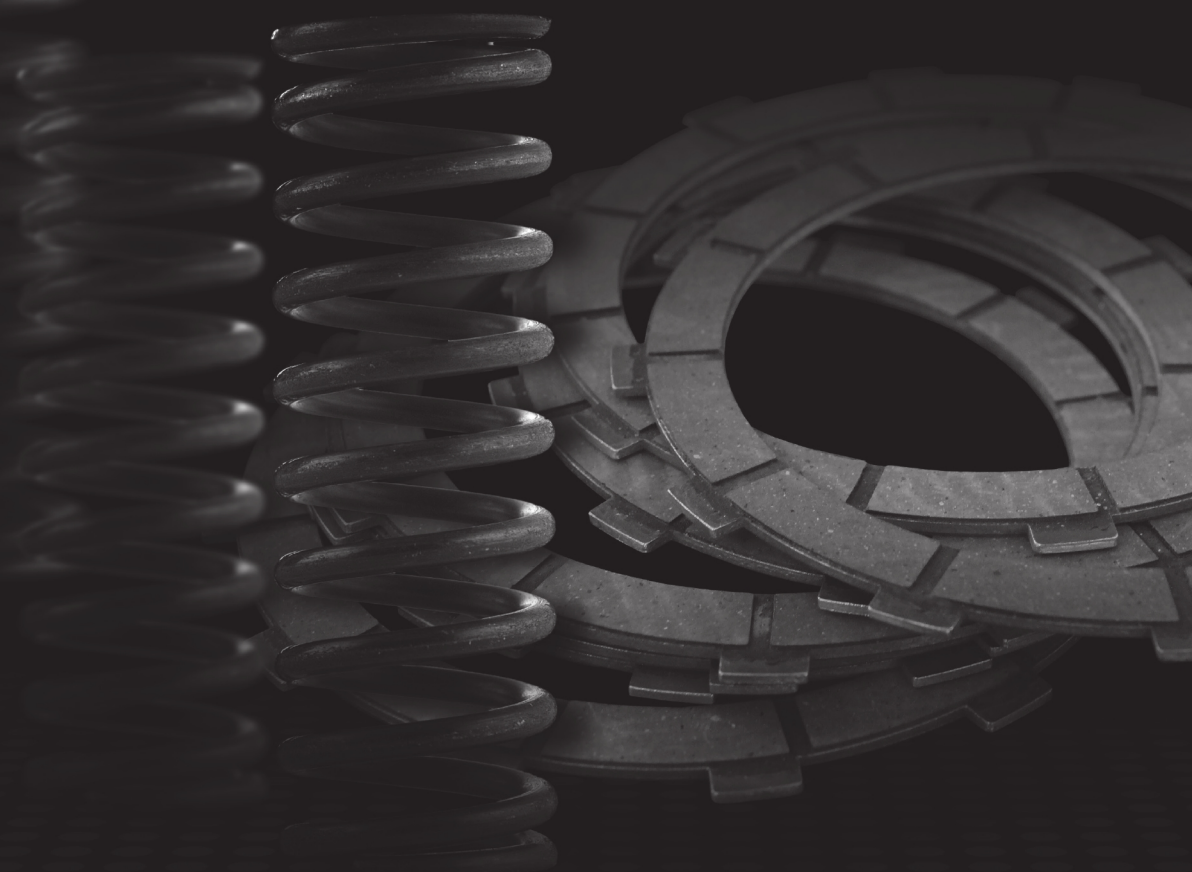

FERODO[®]

MOTORCYCLE

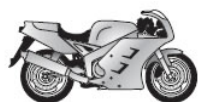

KIT RANGE



HIGH PERFORMANCE



HIGH PERFORMANCE

ACCOSSATO

					STANDARD	HIGH PERFORMANCE	STANDARD	HIGH PERFORMANCE
CE 50	50	1987 →			FCD0523	FCD0523/1	FCS0523/2	FCS0523/3
CR 50 CROSS COMPETIZIONE	50	1984 →			FCD0523	FCD0523/1	FCS0523/2	FCS0523/3
CR 50 ENDURO	50	1984 →			FCD0523	FCD0523/1	FCS0523/2	FCS0523/3
CR 50 ENDURO COMPETIZIONE	50	1984 →			FCD0523	FCD0523/1	FCS0523/2	FCS0523/3
50 CROSS	50	→ 1983			FCD0523	FCD0523/1	FCS0523/2	FCS0523/3
50 CROSS MINI	50	1982 →			FCD0523	FCD0523/1	FCS0523/2	FCS0523/3
50 ENDURO	50	→ 1983			FCD0523	FCD0523/1	FCS0523/2	FCS0523/3
50 ENDURO CODICE	50	1989 →			FCD0523	FCD0523/1	FCS0523/2	FCS0523/3
CE 80 CROSS H20	80	1984 →			FCD0523	FCD0523/1	FCS0523/2	FCS0523/3
CE 80 ENDURO H20	80	1984 →			FCD0523	FCD0523/1	FCS0523/2	FCS0523/3
CE 80	80	1987 →			FCD0523	FCD0523/1	FCS0523/2	FCS0523/3
80 CROSS	80	→ 1983			FCD0523	FCD0523/1	FCS0523/2	FCS0523/3
KR 80	80	1987 →			FCD0523	FCD0523/1	FCS0523/2	FCS0523/3
CE 125 CROSS H20	125	1984 →			FCD0523	FCD0523/1	FCS0523/2	FCS0523/3
CE 125 ENDURO H20	125	1984 →			FCD0523	FCD0523/1	FCS0523/2	FCS0523/3

APRILIA

AF1 50	50	1988 → 1992	FSS0506		FCD0636		FCS0636/2	
AF1 50 EUROPA	50	1990 → 1992	FSS0506		FCD0636		FCS0636/2	
AF1 50 FUTURA	50	1990 → 1992	FSS0506		FCD0636		FCS0636/2	
CLASSIC 50	50	1992 → 1999			FCD0608	FCD0608/1	FCS0608/2	FCS0608/3
ET 50	50	1984 → 1986			FCD0587			
ET 50 AE	50	1987 →	FSS0506		FCD0636		FCS0636/2	
ETX 50	50	1986 →	FSS0506		FCD0636		FCS0636/2	
EUROPA 50	50	1991 → 1992			FCD0608	FCD0608/1	FCS0608/2	FCS0608/3
MX 50	50	→ 1983			FCD0587			
MX 50 MOTARD	50	2003 → 2006			FCD0608	FCD0608/1	FCS0608/2	FCS0608/3
PEGASO 50	50	1992 → 1994			FCD0608	FCD0608/1	FCS0608/2	FCS0608/3
RC 50	50	→ 1983			FCD0587			
RC 50 SPECIAL	50	→ 1983			FCD0587			
RED ROSE 50	50	1988 → 1991	FSS0506		FCD0636		FCS0636/2	
RED ROSE 50	50	1992 →	FSS0506		FCD0636		FCS0636/2	
RS 50	50	1991 → 1998			FCD0608	FCD0608/1	FCS0608/2	FCS0608/3
RS 50	50	2000 → 2005			FCD0608	FCD0608/1	FCS0608/2	FCS0608/3
RS 50 REPLICA	50	2003 → 2005			FCD0608	FCD0608/1	FCS0608/2	FCS0608/3
RS 50	50	2006 → 2010	FSS0507		FCD0585	FCD0585/1	FCS0585/2	FCS0585/3
RS4 50	50	2011 → 2014	FSS0507		FCD0585	FCD0585/1	FCS0585/2	FCS0585/3
RX 50	50	1989 → 1991	FSS0506		FCD0636		FCS0636/2	
RX 50 ENDURO	50	1995 → 2003			FCD0608	FCD0608/1	FCS0608/2	FCS0608/3
RX 50 RACING	50	2003 → 2006			FCD0608	FCD0608/1	FCS0608/2	FCS0608/3
RX 50	50	2003 → 2004			FCD0608	FCD0608/1	FCS0608/2	FCS0608/3
RX 50	50	2006 → 2014	FSS0507		FCD0585	FCD0585/1	FCS0585/2	FCS0585/3
SX 50	50	2006 → 2014	FSS0507		FCD0585	FCD0585/1	FCS0585/2	FCS0585/3
SX 50 LIMITED EDITION	50	2014 →	FSS0507		FCD0585	FCD0585/1	FCS0585/2	FCS0585/3
TUAREG 50	50	1984 → 1985			FCD0587			
TUAREG 50 (freno a disco)	50	1984 → 1985	FSS0506		FCD0636		FCS0636/2	
TUAREG 50	50	1986 →	FSS0506		FCD0636		FCS0636/2	
TUAREG 50 (freno a disco)	50	1986 →			FCD0587			
TUAREG 50 HPC SYSTEM	50	1987 →	FSS0506		FCD0636		FCS0636/2	
TUAREG 50 RALLY	50	1990 → 1992	FSS0506		FCD0636		FCS0636/2	
TUONO 50	50	2003 →	FSS0506		FCD0636		FCS0636/2	
AF1 125 SINTESI	125	1988 →			FCD0682	FCD0682/1		
AF1 125	125	1989 → 1991			FCD0580			
AF1 125 SINTESI REPLICA	125	1989 → 1991			FCD0682	FCD0682/1		
AF1 125 EUROPA	125	1990 → 1992			FCD0682	FCD0682/1		
AF1 125 FUTURA	125	1990 → 1991			FCD0682	FCD0682/1		
CLASSIC 125	125	1995 → 2001			FCD0557	FCD0557/1	FCS0557/2	FCS0557/3
ETX 125	125	1985 → 1997			FCD0580			
MX 125	125	2004 → 2008			FCD0557	FCD0557/1	FCS0557/2	FCS0557/3
PEGASO 125	125	1989 → 1991			FCD0682	FCD0682/1		
RED ROSE 125	125	1987 → 1994			FCD0682	FCD0682/1		
RS 125	125	1992 → 1994			FCD0682	FCD0682/1		
RS 125	125	1995 →			FCD0557	FCD0557/1	FCS0557/2	FCS0557/3
RX 125	125	1986 →			FCD0682	FCD0682/1		
TUAREG 125	125	1986 →			FCD0580			
TUAREG 125 RALLY	125	1986 → 1988			FCD0557	FCD0557/1	FCS0557/2	FCS0557/3
TUAREG 125 RALLY(Mozzi Rimoldi)	125	1986 →			FCD0580			
TUAREG 125 RALLY	125	1989 → 1992			FCD0682	FCD0682/1		
TUONO 125	125	2003 → 2004			FCD0557	FCD0557/1	FCS0557/2	FCS0557/3
CLIMBER 240	240	1988 → 1990			FCD0580			
CLIMBER 240	240	1991 → 1994			FCD0682	FCD0682/1		
TX 240	240	1985 →			FCD0580			
RS 250	250	1995 → 2003	FSS0201		FCD0308	FCD0308/1		FCS0308/3
RS 250 PISTA	250	2004 →	FSS0201		FCD0308	FCD0308/1		FCS0308/3
TUAREG 250	250	1984 → 1985			FCD0581	FCD0581/1		

20000

FERODO

RACING

Updated on November 2020

FCDXXXX
FCDXXXX/1
FCSXXXX/2
FCSXXXX/3STANDARD
HIGH PERFORMANCE
STANDARD
HIGH PERFORMANCEFRICTION PLATES ONLY
FRICTION PLATES ONLY
FRICTION PLATES + STEEL PLATES
FRICTION PLATES + STEEL PLATES



KIT RANGE



HIGH PERFORMANCE



HIGH PERFORMANCE

...APRILIA

					STANDARD	HIGH PERFORMANCE	STANDARD	HIGH PERFORMANCE
TUAREG 250 RALLY	250	1986	→		FCD0581	FCD0581/1		
TUAREG 250 RALLY (Mozzi Rimoldi)	250	1986	→ 1988		FCD0581	FCD0581/1		
TX 300	300	1985	→		FCD0580			
TX 300	300	1986	→		FCD0580			
TX 311	311	1987	→		FCD0580			
TX 312	312	1988	→		FCD0580			
TXR 312	312	1988	→		FCD0580			
ETX 350	350	1985	→ 1986		FCD0516			
ETX 350 AF	350	1987	→		FCD0580			
TUAREG 350	350	1987	→		FCD0580			
TUAREG 350 WIND	350	1987	→		FCD0580			
MOTO 650 6.5	650	1995	→ 2000	FSS0503	FCD0641	FCD0641/1	FCS0641/2	FCS0641/3
PEGASO 650	650	1991	→ 1995	FSS0503	FCD0641	FCD0641/1	FCS0641/2	FCS0641/3
PEGASO 650	650	1996	→	FSS0503	FCD0641	FCD0641/1	FCS0641/2	FCS0641/3
PEGASO 650 3	650	1997	→ 2000	FSS0503	FCD0641	FCD0641/1	FCS0641/2	FCS0641/3
PEGASO 650 IE	650	2001	→ 2004	FSS0503	FCD0641	FCD0641/1	FCS0641/2	FCS0641/3
PEGASO 660 STRADA	660	2005	→ 2009		FCD0737			
PEGASO 660 TRAIL	660	2006	→ 2008		FCD0737			
PEGASO 660 FACTORY	660	2007	→ 2009		FCD0737			
ETV 1000 CAPONORD	1000	2001	→ 2003	FSS0503	FCD0697	FCD0697/1		
ETV 1000 CAPONORD ABS	1000	2004	→ 2007	FSS0503	FCD0697	FCD0697/1		
ETV 1000 CAPONORD RALLY RAID	1000	2004	→	FSS0503	FCD0697	FCD0697/1		
RST 1000 FUTURA	1000	2001	→ 2003	FSS0503	FCD0697	FCD0697/1		
RSV 1000 MILLE	1000	1998	→ 2002	FSS0503	FCD0586	FCD0586/1	FCS0586/2	FCS0586/3
RSV 1000 SP	1000	1999	→ 2000	FSS0503	FCD0586	FCD0586/1	FCS0586/2	FCS0586/3
RSV 1000 TUONO	1000	2002	→ 2005	FSS0503	FCD0697	FCD0697/1		
RSV 1000 TUONO FIGTHER	1000	2003	→ 2005	FSS0503	FCD0697	FCD0697/1		
RSV 1000 MILLE NERA	1000	2004	→ 2008	FSS0503	FCD0697	FCD0697/1		
RSV-R 1000 MILLE	1000	2000	→ 2002	FSS0503	FCD0586	FCD0586/1	FCS0586/2	FCS0586/3
RSV-R 1000 MILLE	1000	2003	→ 2005	FSS0503	FCD0697	FCD0697/1		
RSV-R 1000 TUONO	1000	2003	→ 2005	FSS0503	FCD0697	FCD0697/1		
RSV-R 1000 FACTORY	1000	2004	→ 2008	FSS0503	FCD0697	FCD0697/1		
RSV-R 1000 TUONO FACTORY	1000	2006	→ 2009	FSS0503	FCD0697	FCD0697/1		
RSV4 1000 FACTORY	1000	2009	→ 2010		FCD0698	FCD0698/1		FCS0698/3
RSV4 1000 SBK RACING	1000	2009	→ 2010		FCD0698	FCD0698/1		FCS0698/3
RSV4-R 1000	1000	2010	→		FCD0698	FCD0698/1		FCS0698/3
RSV4 1000 FACTORY APRC	1000	2011	→ 2012		FCD0699	FCD0699/1		
RSV4 1000 FACTORY APRC R - ABS	1000	2011	→ 2013		FCD0699	FCD0699/1		
RSV4 1000 FACTORY APRC STD-SE	1000	2011	→ 2012		FCD0699	FCD0699/1		
RSV4-R 1000 APRC - ABS	1000	2011	→ 2014		FCD0699	FCD0699/1		
RSV4 1000 FACTORY ABS	1000	2013	→		FCD0699	FCD0699/1		
SL 1000 FALCO	1000	2000	→ 2003	FSS0503	FCD0586	FCD0586/1	FCS0586/2	FCS0586/3
TUONO 1000 V4R STD APRC	1000	2011	→ 2013		FCD0699	FCD0699/1		
TUONO 1000 V4R APRC	1000	2014	→		FCD0699	FCD0699/1		
BERINI								
ANKER 1 old models	1		→		FCD0658			
BETA								
MX 50 ENDURO	50	1992	→		FCD0648			
MX4 50 Special	50	1970	→		FCD0648			
MX6 50 EXPORT	50	1977	→		FCD0648			
MX6 50	50	1982	→		FCD0648			
RX 50	50	1984	→		FCD0648			
RK 60	60		→		FCD0664			
TZR 125 motore Minarelli RK 6	125		→		FCD0531			
ALP 240	240	1991	→ 1995		FCD0643		FCS0643/2	
TR 240	240	1980	→ 1983		FCD0643		FCS0643/2	
TR 32 240	240	1984	→ 1985		FCD0643		FCS0643/2	
TR 32 240 (mozzo ant autocentrante)	240	1984	→ 1985		FCD0643		FCS0643/2	
TR 33 240	240	1986	→ 1988		FCD0643		FCS0643/2	
TR 33 TREKKING 240	240	1987	→		FCD0643		FCS0643/2	
TREKKING 240	240	1987	→		FCD0643		FCS0643/2	
RR 250 2T ENDURO	250	2014	→ 2017		FCD1317	FCD1317/1	FCS1317/2	FCS1317/3
TECHNO 250	250	1994	→ 1999		FCD0574			
TR 34 250	250	1987	→ 1988		FCD0643		FCS0643/2	
TR 34 250 (SPAIN)	250	1989	→		FCD0643		FCS0643/2	
TR 34 250 PROFESSIONAL	250	1989	→		FCD0643		FCS0643/2	
TR 35 250	250	1990	→ 1991		FCD0564			
TR 36 250	250	1992	→		FCD0564			
TR 35 250	250	1992	→		FCD0564			
RR 300 2T ENDURO	300	2013	→ 2017		FCD1317	FCD1317/1	FCS1317/2	FCS1317/3
RR 350 4T ENDURO	350	2011	→ 2017		FCD1317	FCD1317/1	FCS1317/2	FCS1317/3
RR 350 4T FACTORY	350	2011	→ 2011		FCD1317	FCD1317/1	FCS1317/2	FCS1317/3

FCDXXXX STANDARD FRICTION PLATES ONLY
 FCDXXXX/1 HIGH PERFORMANCE FRICTION PLATES ONLY
 FCSXXXX/2 STANDARD FRICTION PLATES + STEEL PLATES
 FCSXXXX/3 HIGH PERFORMANCE FRICTION PLATES + STEEL PLATES

FERODO
 RACING
 Updated on November 2020

20001

BETA



KIT RANGE



HIGH PERFORMANCE



HIGH PERFORMANCE

BETA

				STANDARD	HIGH PERFORMANCE	STANDARD	HIGH PERFORMANCE
RR 350 4T FACTORY	350	2012	→	FCD1336	FCD1336/1	FCS1336/2	FCS1336/3
TECHNO 352	352	1996	→	FCD0574			
RR 390 4T ENDURO	390	2015	→ 2017	FCD1317	FCD1317/1	FCS1317/2	FCS1317/3
RR 400 4T FACTORY	400	2010	→ 2011	FCD1336	FCD1336/1	FCS1336/2	FCS1336/3
RR 400 4T ENDURO	400	2011	→ 2014	FCD1317	FCD1317/1	FCS1317/2	FCS1317/3
RR 430 4T ENDURO	430	2015	→ 2017	FCD1317	FCD1317/1	FCS1317/2	FCS1317/3
RR 450 4T FACTORY	450	2010	→ 2012	FCD1336	FCD1336/1	FCS1336/2	FCS1336/3
RR 450 4T ENDURO	450	2011	→ 2015	FCD1317	FCD1317/1	FCS1317/2	FCS1317/3
RR 480 4T ENDURO	480	2015	→ 2017	FCD1317	FCD1317/1	FCS1317/2	FCS1317/3
RR 498 4T ENDURO	498	2012	→ 2014	FCD1317	FCD1317/1	FCS1317/2	FCS1317/3
RR 498 4T FACTORY	498	2012	→	FCD1336	FCD1336/1	FCS1336/2	FCS1336/3
RR 520 4T FACTORY	520	2010	→ 2011	FCD1336	FCD1336/1	FCS1336/2	FCS1336/3
RR 520 4T ENDURO	520	2011	→	FCD1317	FCD1317/1	FCS1317/2	FCS1317/3

BMW

R 45 450 (21_0068 - 248)(a 09/80)	450	1978	→ 1980	FCD0657			
R 45 450 (21_0067 - 248)(da 09/80)	450	1980	→ 1985	FCD0627			
R 45 N 450 (21_0067 - 248)(da 09/80)	450	1980	→ 1985	FCD0627			
R 45 T 450	450	1980	→ 1985	FCD0627			
R 45 T/N 450	450	1980	→ 1985	FCD0627			
R 50/5 500	500	1969	→ 1973	FCD0540			
R 60/5 600	600	1969	→ 1973	FCD0540			
R 60/6 600	600	1973	→ 1976	FCD0540			
R 60/7 600	600	1976	→ 1980	FCD0540			
R 60 TIC 600	600	1978	→ 1982	FCD0540			
F 650	650	1993	→ 2003	FSS0503	FCD0641	FCD0641/1	FCS0641/2
F 650 ST	650	1996	→ 2000	FSS0503	FCD0641	FCD0641/1	FCS0641/2
F 650 ST STRADA	650	1997	→ 2000	FSS0503	FCD0641	FCD0641/1	FCS0641/2
F 650 GS	650	1999	→ 2003	FSS0503	FCD0688		FCS0688/2
F 650 DAKAR	650	1999	→ 2003	FSS0503	FCD0688		FCS0688/2
F 650 CS SCARVER	650	2000	→ 2003	FSS0503	FCD0688		FCS0688/2
F 650 GS ABS	650	2002	→ 2003	FSS0503	FCD0688		FCS0688/2
F 650 GS	650	2004	→ 2007	FSS0503	FCD0689	FCD0689/1	
F 650 GS ABS	650	2004	→ 2007	FSS0503	FCD0689	FCD0689/1	
F 650 DAKAR	650	2004	→ 2007	FSS0503	FCD0689	FCD0689/1	
F 650 CS SCARVER	650	2004	→ 2007	FSS0503	FCD0689	FCD0689/1	
F 650 GS	650	2006	→ 2012	FCD1318	FCD1318/1	FCS1318/2	FCS1318/3
F 650 GS ABS	650	2006	→ 2012	FCD1318	FCD1318/1	FCS1318/2	FCS1318/3
R 65 650 (21_0068 - 248)(a 09/80)	650	1978	→ 1980	FCD0657			
R 65 650 (21_0067 - 248)(da 09/80)	650	1980	→ 1985	FCD0627			
R 65 T 650	650	1980	→ 1985	FCD0627			
R 65 650 LS	650	1981	→ 1985	FCD0627			
R 65 650 20 KW	650	1985	→ 1993	FCD0627			
R 65 650 35 KW	650	1985	→ 1988	FCD0627			
R 65 RT 650	650	1985	→ 1988	FCD0627			
R 65 650 GS	650	1987	→ 1992	FCD0627			
F 700 GS	700	2013	→ 2017	FCD1318	FCD1318/1	FCS1318/2	FCS1318/3
K 75 750	750	1984	→ 1988	FCD0529			
K 75 C 750 C	750	1985	→ 1988	FCD0529			
K 75 S 750	750	1988	→ 1995	FCD0529			
K 75 RT 750	750	1989	→ 2005	FCD0529			
R 75/5 750	750	1969	→ 1975	FCD0540			
R 75/6 750	750	1973	→ 1976	FCD0540			
R75/7 750	750	1975	→ 1979	FCD0540			
R 75/5 750	750	1976	→ 1980	FCD0540			
F 800 S	800	2006	→ 2010	FCD1318	FCD1318/1	FCS1318/2	FCS1318/3
F 800 ST	800	2006	→ 2012	FCD1318	FCD1318/1	FCS1318/2	FCS1318/3
F 800 GS	800	2008	→ 2018	FCD1318	FCD1318/1	FCS1318/2	FCS1318/3
F 800 R	800	2009	→ 2018	FCD1318	FCD1318/1	FCS1318/2	FCS1318/3
F 800 ST TOURING	800	2011	→ 2012	FCD1318	FCD1318/1	FCS1318/2	FCS1318/3
F 800 GS ADVENTURE	800	2013	→ 2017	FCD1318	FCD1318/1	FCS1318/2	FCS1318/3
F 800 GT	800	2013	→ 2018	FCD1318	FCD1318/1	FCS1318/2	FCS1318/3
R 80 800 (single disc)	800	1977	→ 1984	FCD0627			
R 80 800 (twin disc)	800	1977	→ 1984	FCD0627			
R 80 TIC 800 (21_0072 - 2474)(a 09/80)	800	1977	→ 1980	FCD0540			
R 80 GS 800	800	1980	→ 1995	FCD0627			
R 80 TIC 800 (21_0067 - 2474)(da 09/80)	800	1980	→ 1985	FCD0627			
R 80 RT 800 (twin disc)	800	1982	→ 1995	FCD0627			
R 80 ST 800	800	1982	→ 1984	FCD0627			
R 80 R 800 (single disc)	800	1984	→ 1995	FCD0627			
R 80 R 800 (twin disc)	800	1984	→ 1995	FCD0627			
R 80 RT 800 (single disc)	800	1984	→ 1995	FCD0627			
R 80 GS 800 PD	800	1990	→ 1995	FCD0627			
R 80 R 800 R	800	1991	→ 1994	FCD0627			
R 80 R 800 R MYSTIK	800	1994	→ 1995	FCD0627			



KIT RANGE



STANDARD

HIGH PERFORMANCE



STANDARD

HIGH PERFORMANCE

...BMW

				STANDARD	HIGH PERFORMANCE	STANDARD	HIGH PERFORMANCE
R 850 R (21_0097 - 259R)	850	1994 → 2001		FCD0652			
R 850 GS	850	1996 → 2000		FCD0652			
R 850 RT (21_0097 - 259T)	850	1996 → 2001		FCD0652			
R 850 C	850	1997 → 2000		FCD0617			
R 850 R (21_0145 - R28)	850	1999 → 2007		FCD0617			
R 850 RT (21_0145 - R22)	850	2000 → 2006		FCD0617			
R 850 R (21_0097 - 259R)	850	2002 →		FCD0652			
R 90 S 900	900	1973 → 1976		FCD0540			
R 90/6 900	900	1973 → 1976		FCD0540			
R 900 RT	900	2005 → 2013		FCD0738			
K 100 1000	1000	1982 → 1988		FCD0652			
K 100 RT 1000	1000	1983 → 1988		FCD0652			
K 100 LT 1000	1000	1986 → 1991		FCD0652			
K 1 1000	1000	1988 → 1993		FCD0652			
K 100 RS 1000	1000	1989 → 1992		FCD0652			
K 100 RT 1000	1000	1989 →		FCD0652			
R 100 1000 S	1000	1976 → 1980		FCD0540			
R 100 RS 1000 (21_0072 - 2474)(a 09/80)	1000	1976 → 1980		FCD0540			
R 100/7 1000	1000	1976 → 1977		FCD0540			
R 100/7T 1000 (21_0072 - 2474)(a 09/80)	1000	1977 → 1980		FCD0540			
R 100 RT 1000 (21_0072 - 2474)(a 09/80)	1000	1978 → 1980		FCD0540			
R 100 1000 S (da 09/80)	1000	1980 →		FCD0540			
R 100 CS 1000	1000	1980 → 1984		FCD0627			
R 100 RS 1000 (21_0067 - 2474)(da 09/80)	1000	1980 → 1984		FCD0627			
R 100 RT 1000 (21_0067 - 2474)(da 09/80)	1000	1980 → 1984		FCD0627			
R 100 TIC 1000	1000	1980 → 1984		FCD0627			
R 100/7T 1000 (21_0067 - 2474)(da 09/80)	1000	1980 → 1984		FCD0627			
R 100 GS 1000	1000	1986 → 1994		FCD0627			
R 100 RS 1000 (21_0067 - 2478)	1000	1986 → 1992		FCD0627			
R 100 RT 1000	1000	1987 → 1995		FCD0627			
R 100 GS 1000 PD	1000	1989 → 1996		FCD0627			
R 100 R 1000	1000	1991 → 1995		FCD0627			
R 100 R 1000 MYSTIK	1000	1993 → 1996		FCD0627			
S 1000 RR	1000	2009 → 2017			FCD0752/1		FCS0752/3
S 1000 RR HP4	1000	2009 → 2014			FCD0752/1		FCS0752/3
S 1000 R	1000	2013 → 2017			FCD0752/1		FCS0752/3
S 1000 XR	1000	2014 → 2017			FCD0752/1		FCS0752/3
K 1100 LT	1100	1989 → 1999		FCD0652			
K 1100 LT / SE	1100	1992 → 2000		FCD0652			
K 1100 RS	1100	1992 → 1996		FCD0652			
R 1100 RS	1100	1992 → 2001		FCD0652			
R 1100 GS	1100	1993 → 1999		FCD0652			
R 1100 R	1100	1993 → 2001		FCD0652			
R 1100 RT	1100	1994 → 2001		FCD0652			
R 1100 S	1100	1996 → 2005		FCD0617			
R 1100 S BOXER CUP REPLICA	1100	2003 → 2006		FCD0617			
R 1150 R	1150	1999 → 2006		FCD0617			
R 1150 GS	1150	2000 → 2003		FCD0617			
R 1150 RS	1150	2000 → 2004		FCD0617			
R 1150 RT	1150	2000 → 2006		FCD0617			
R 1150 GS ADV	1150	2001 → 2005		FCD0617			
R 1150 R ROCKSTER	1150	2002 → 2005		FCD0617			
R nineT	1170	2013 → 2017		FCD0738			
R nineT Pure	1170	2015 → 2017		FCD0738			
R nineT Racer	1170	2015 → 2017		FCD0738			
R nineT Scrambler	1170	2015 → 2017		FCD0738			
R nineT Urban G/S	1170	2016 → 2017		FCD0738			
HP2 1200 Enduro	1200	2005 → 2009		FCD0738			
HP2 1200 Megamoto	1200	2007 → 2010		FCD0738			
HP2 1200 Sport	1200	2008 → 2011		FCD0738			
K 1200 RS	1200	1996 → 2000		FCD0653			
K 1200 LT	1200	1997 → 2008		FCD0653			
K 1200 RS	1200	2001 → 2005		FCD0653			
K 1200 GT (K41)	1200	2002 → 2005		FCD0653			
R 1200 C	1200	1996 → 2002		FCD0617			
R 1200 CI	1200	2000 → 2003		FCD0617			
R 1200 CL	1200	2001 → 2004		FCD0617			
R 1200 GS	1200	2002 → 2012		FCD0738			
R 1200 MONTAUK	1200	2002 → 2004		FCD0617			
R 1200 C I/M	1200	2003 → 2004		FCD0617			
R 1200 RT	1200	2003 → 2014		FCD0738			
R 1200 ST	1200	2003 → 2007		FCD0738			
R 1200 C INDEPENDENT	1200	2003 →		FCD0617			
R 1200 S	1200	2004 → 2006		FCD0738			
R 1200 C MONTAUK	1200	2004 →		FCD0617			
R 1200 GS ADV	1200	2005 → 2013		FCD0738			

FCDXXXX STANDARD FRICTION PLATES ONLY
FCDXXXX/1 HIGH PERFORMANCE FRICTION PLATES ONLY
FCSXXXX/2 STANDARD FRICTION PLATES + STEEL PLATES
FCSXXXX/3 HIGH PERFORMANCE FRICTION PLATES + STEEL PLATES

FERODO
RACING
Updated on November 2020

2003



KIT RANGE



STANDARD

HIGH PERFORMANCE



STANDARD

HIGH PERFORMANCE

...BMW

R 1200 R

1200 2005 → 2014

FCD0738

BULTACO

LOBITO 50	50	1999 → 2013	FSS0507	FCD0585	FCD0585/1	FCS0585/2	FCS0585/3	
LOBITO 74	74	1976 →				FCS0616/2		
BRINCO 75	75	1973 → 1976						
FRONTERA 75	75	1976 → 1981				FCS0616/2		
JUNIOR 75 GT2	75	→						
JUNIOR 75	75	→						
LOBITO 75 MK3	75	1969 → 1972				FCS0616/2		
LOBITO 75 MK6	75	1973 →						
LOBITO 75 MK8	75	1974 →						
LOBITO 75 MK8	75	1975 →						
STREAKER 75	75	1977 → 1982				FCS0616/2		
TIRON 75	75	1971 → 1974						
JUNIOR 100	100	→						
LOBITO 100 MK3	100	1969 → 1972				FCS0616/2		
SHERPA S 100	100	1961 → 1972						
FRONTERA 125	125	1976 → 1981				FCS0616/2		
JUNIOR 125	125	→						
LOBITO 125	125	→				FCS0616/2		
LOBITO 125 MK3	125	1969 → 1972				FCS0616/2		
LOBITO 125 MK4/5/7/8	125	1971 → 1975				FCS0616/2		
LOBITO 125 MK6	125	1973 →						
PURSANG 125 MK5	125	1972 →				FCS0605/2		
PURSANG 125 MK6	125	1973 →				FCS0605/2		
PURSANG 125 MK7/8	125	1974 → 1975				FCS0616/2		
PURSANG 125 MK9/10	125	1976 → 1977				FCS0616/2		
SHERPA S 125	125	1961 → 1972						
STREAKER 125	125	1977 → 1982				FCS0616/2		
TSS 125	125	→				FCS0605/2		
155 150	150	→						
TRALLA 150 101/102	150	→						
MERCURIO 155	155	1966 → 1974						
SHERPA N 155	155	1960 → 1965						
CAMPERA 175 MK2	175	1969 → 1972				FCS0616/2		
LOBITO 175 MK4/5/6/7/8	175	1971 → 1975				FCS0616/2		
MERCURIO 175	175	1966 → 1974						
SENIOR 175	175	→				FCS0743/2		
SHERPA S 175	175	1961 → 1972						
EL TIGRE 200	200	1966 → 1969				FCS0616/2		
PURSANG 200 METISE	200	→				FCS0743/2		
PURSANG 200 MK8/9/10	200	1974 → 1977				FCS0616/2		
SATURNO 200	200	→				FCS0743/2		
SHERPA N 200	200	→						
SHERPA S 200	200	1961 → 1972						
TSS 200	200	→				FCS0605/2		
ALPINA 250	250	1971 → 1980				FCS0616/2		
ASTRO 90 250	250	1972 →				FCS0605/2		
ASTRO 105 250	250	1973 →				FCS0605/2		
ASTRO 145 250	250	1975 → 1976				FCS0616/2		
ASTRO 163 250	250	1977 →				FCS0616/2		
ASTRO 195 250	250	1978 → 1979				FCS0605/2		
FRONTERA 250 MK9	250	1975 → 1976				FCS0616/2		
FRONTERA 250 GM	250	1977 → 1979				FCS0616/2		
FRONTERA 250 MK10	250	1977 → 1978				FCS0605/2		
FRONTERA 250 MK11/12	250	1979 → 1981				FCS0649/2		
MATADOR 250 MK2	250	→				FCS0743/2		
MATADOR 250 MK3/4/5/9/10	250	1967 → 1979				FCS0616/2		
METRALLA 250 MK2	250	1966 → 1974				FCS0616/2		
METRALLA 250 GT/GTS	250	1975 → 1980				FCS0616/2		
PURSANG 250 MK2/3/4	250	1967 → 1971						
PURSANG 250 MK5	250	1972 →				FCS0605/2		
PURSANG 250 MK6	250	1973 →				FCS0605/2		
PURSANG 250 MK7/8/10	250	1975 → 1977				FCS0616/2		
PURSANG 250 MK11/12	250	1978 →				FCS0649/2		
SHERPA T 250 (MOD 49)	250	1968 → 1971						
SHERPA 250 T MO	250	1971 → 1981				FCS0616/2		
TSS 250	250	→				FCS0605/2		
ALPINA 350	350	1971 → 1980				FCS0616/2		
BANDIDO 350 MK1/2/3	350	1967 → 1973						
MONTADERO 350 MK1/2/3	350	1968 → 1971						
PURSANG 350 MK5	350	1972 →				FCS0605/2		
PURSANG 350 MK6	350	1973 →				FCS0605/2		
PURSANG 350 MK11/12	350	1978 →				FCS0649/2		

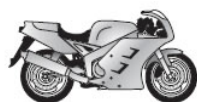

KIT RANGE

STANDARD
HIGH PERFORMANCESTANDARD
HIGH PERFORMANCE**...BULTACO**

SHERPA 350 T MO	350	1971 → 1981					
ASTRO 90 360	360	1972 →				FCS0616/2	
ASTRO 105 360	360	1973 →				FCS0605/2	
ASTRO 125 360	360	1974 →				FCS0605/2	
ASTRO 146 360	360	1975 → 1976				FCS0605/2	
ASTRO 164 360	360	1977 →				FCS0605/2	
BANDIDO 360 MK1/2/3	360	1967 → 1973					
FRONTERA 360 MK9	360	1975 → 1976				FCS0605/2	
MONTADERO 360 MK1/2/3	360	1968 → 1971					
MONTJUIC 360	360	1980 →				FCS0616/2	
PURSANG 360 MK7/8	360	1974 → 1975				FCS0605/2	
FRONTERA 370 GM	370	1977 → 1979				FCS0605/2	
FRONTERA 370 MK10	370	1977 → 1978				FCS0605/2	
FRONTERA 370 MK11/12	370	1979 → 1981				FCS0649/2	
PURSANG 370 MK9/10	370	1976 → 1977				FCS0605/2	

CAGIVA

COCIS 50	50	1988 →		FCD0592			
MITO 50	50	1998 → 2001	FSS0507	FCD0585	FCD0585/1	FCS0585/2	FCS0585/3
COCHIS 75	75	1989 →		FCD0741			
ALETTA 125 ORO S2	125	1986 →		FCD0593	FCD0593/1	FCS0593/2	FCS0593/3
BLUES 125	125	1988 → 1992		FCD0593	FCD0593/1	FCS0593/2	FCS0593/3
BLUES 125	125	1993 →		FCD0593	FCD0593/1	FCS0593/2	FCS0593/3
CRUISER 125	125	1987 →		FCD0593	FCD0593/1	FCS0593/2	FCS0593/3
DAKAR 125	125	1985 →		FCD0614	FCD0614/1		
ELEFANT 125	125	1984 →		FCD0614	FCD0614/1		
ELEFANT 125	125	1985 → 1986		FCD0614	FCD0614/1		
ELEFANTRE 125	125	1987 →		FCD0593	FCD0593/1	FCS0593/2	FCS0593/3
FRECCIA 125 C10 all models	125	1988 →		FCD0614	FCD0614/1		
FRECCIA 125 C9	125	1988 →		FCD0614	FCD0614/1		
FRECCIA 125 C12 R	125	1989 →		FCD0593	FCD0593/1	FCS0593/2	FCS0593/3
MITO 125	125	1991 → 1992		FCD0593	FCD0593/1	FCS0593/2	FCS0593/3
MITO 125 EDDY	125	1993 →		FCD0593	FCD0593/1	FCS0593/2	FCS0593/3
MITO 125 EV	125	1994 → 2003		FCD0593	FCD0593/1	FCS0593/2	FCS0593/3
MITO 2 125 PRODUCTION RACER	125	1994 →		FCD0593	FCD0593/1	FCS0593/2	FCS0593/3
MITO 125 EURO 2	125	2005 →		FCD0593	FCD0593/1	FCS0593/2	FCS0593/3
SST 125 ruota integrale	125	1981 →		FCD0577		FCS0577/2	
SST 125 ruota raggi	125	1981 →		FCD0577		FCS0577/2	
SST 125 LOW RIDER	125	1983 →		FCD0577		FCS0577/2	
SXT 125	125	1982 →		FCD0614	FCD0614/1		
TAMANACO 125	125	1988 →		FCD0593	FCD0593/1	FCS0593/2	FCS0593/3
WMX 125	125	→ 1982		FCD0593	FCD0593/1	FCS0593/2	FCS0593/3
WMX 125 /3	125	→ 1983		FCD0593	FCD0593/1	FCS0593/2	FCS0593/3
WMX 125 (mozzi Rimoldi)	125	1984 →		FCD0593	FCD0593/1	FCS0593/2	FCS0593/3
WMX 125 CROSS	125	1986 →		FCD0593	FCD0593/1	FCS0593/2	FCS0593/3
WR 125	125	1993 →		FCD0593	FCD0593/1	FCS0593/2	FCS0593/3
WRX 125	125	1982 →		FCD0593	FCD0593/1	FCS0593/2	FCS0593/3
WRX 125 /1	125	1983 →		FCD0593	FCD0593/1	FCS0593/2	FCS0593/3
WSXT 125 ALETTA ROSSA	125	1983 →		FCD0614	FCD0614/1		
MXR 250	250	1981 →		FCD0610			
RX 250	250	1981 →		FCD0610			
SX 250	250	1982 →		FCD0594	FCD0594/1	FCS0594/2	
ALA ROSSA 350	350	1983 →		FCD0610			
RX 350	350	1983 →		FCD0610			
T4 350 R - ER	350	1987 →		FCD0610			
ELEFANT 750	750	1993 → 1995		FCD0568		FCS0568/2	
ELEFANT 900 I.E. - GT - AC	900	1991 → 1994		FCD0671		FCS0671/2	
NAVIGATOR 1000	1000	2000 → 2005		FCD0347			
RAPTOR 1000	1000	2000 → 2006		FCD0347			
RAPTOR 1000 XTRA	1000	2002 → 2004		FCD0347			
V-RAPTOR 1000	1000	2000 → 2006		FCD0347			
X-RAPTOR 1000	1000	2003 →		FCD0347			

CASAL

old models 1	1	→		FCD0552			
old models 1 CASAL-SACHS	1	→		FCD0670			

DERBI

DERBI 50	50	→		FCD0622			
DIABLO 50 SUPER	50	→		FCD0553			
DS 50 WORLD CHAMPION	50	1988 →		FCD0533			
FDS 50	50	1986 →		FCD0533			

FCDXXXX STANDARD FRICTION PLATES ONLY
 FCDXXXX/1 HIGH PERFORMANCE FRICTION PLATES ONLY
 FCSXXXX/2 STANDARD FRICTION PLATES + STEEL PLATES
 FCSXXXX/3 HIGH PERFORMANCE FRICTION PLATES + STEEL PLATES

FERODO
 RACING
 Updated on November 2020

2005

DERBI



...DERBI

				KIT RANGE			
				STANDARD	HIGH PERFORMANCE	STANDARD	HIGH PERFORMANCE
FENIX 50	50	1994	→	FCD0645			
FENIX 50	50	1995	→ 1998	FCD0645			
GPR 50 NUDE	50	2004	→	FSS0507	FCD0585	FCD0585/1	FCS0585/2
GPR 50 R DRD PRO EU2	50	2005	→ 2009	FSS0507	FCD0585	FCD0585/1	FCS0585/2
GPR 50 R DRD RACING EU2	50	2005	→ 2008	FSS0507	FCD0585	FCD0585/1	FCS0585/2
GPR 50 SM DRD RACING EU2	50	2005	→ 2008	FSS0507	FCD0585	FCD0585/1	FCS0585/2
GPR 50 SM X-TREME EU2	50	2005	→ 2008	FSS0507	FCD0585	FCD0585/1	FCS0585/2
GPR 50 R X-TREME EU2	50	2005	→ 2008	FSS0507	FCD0585	FCD0585/1	FCS0585/2
GPR 50 NUDE TUNING	50	2006	→ 2008	FSS0507	FCD0585	FCD0585/1	FCS0585/2
GPR 50 REPLICA - R EU2	50	2006	→	FSS0507	FCD0585	FCD0585/1	FCS0585/2
GPR 50 R X-RACE EU2	50	2006	→ 2009	FSS0507	FCD0585	FCD0585/1	FCS0585/2
GPR 50 RACING EU2	50	2006	→	FSS0507	FCD0585	FCD0585/1	FCS0585/2
GPR 50 SM X-RACE EU2	50	2006	→ 2009	FSS0507	FCD0585	FCD0585/1	FCS0585/2
GPR 50 NUDE	50	2006	→ 2008	FSS0507	FCD0585	FCD0585/1	FCS0585/2
GPR 50 REPLICA PESEK EU2	50	2007	→	FSS0507	FCD0585	FCD0585/1	FCS0585/2
GPR 50 SM DRD RACING LTD EU2	50	2007	→	FSS0507	FCD0585	FCD0585/1	FCS0585/2
GPR 50 REPLICA 2T	50	2007	→	FSS0507	FCD0585	FCD0585/1	FCS0585/2
GPR 50 NUDE SPORT	50	2008	→	FSS0507	FCD0585	FCD0585/1	FCS0585/2
GPR 50 R EU2 - REPLICA EU2	50	2008	→	FSS0507	FCD0585	FCD0585/1	FCS0585/2
old models 50 (3 dischi)	50		→	FCD0525			
old models 50 (5 dischi)	50		→	FCD0613			
RD 2 50	50	1989	→	FCD0533			
SENDA 50	50	1994	→	FSS0507	FCD0585	FCD0585/1	FCS0585/2
SENDA 50 L 6V	50	1994	→ 1997	FSS0507	FCD0585	FCD0585/1	FCS0585/2
SENDA 50 R	50	1994	→ 2004	FSS0507	FCD0585	FCD0585/1	FCS0585/2
SENDA 50 R 6V	50	1994	→ 1997	FSS0507	FCD0585	FCD0585/1	FCS0585/2
SENDA 50 X-TREME	50	1994	→ 2004	FSS0507	FCD0585	FCD0585/1	FCS0585/2
SENDA 50 EX	50	1995	→ 1997	FSS0507	FCD0585	FCD0585/1	FCS0585/2
SENDA 50 SUPERMOTARD	50	1997	→ 1999	FSS0507	FCD0585	FCD0585/1	FCS0585/2
SENDA 50 L	50	1999	→	FSS0507	FCD0585	FCD0585/1	FCS0585/2
SENDA 50 SM	50	1999	→	FSS0507	FCD0585	FCD0585/1	FCS0585/2
SENDA 50 SR	50	1999	→	FSS0507	FCD0585	FCD0585/1	FCS0585/2
SENDA 50 R XTREAM	50	2000	→ 2001	FSS0507	FCD0585	FCD0585/1	FCS0585/2
SENDA 50 SM XTREAM	50	2000	→ 2001	FSS0507	FCD0585	FCD0585/1	FCS0585/2
SENDA 50 SUPERMOTARD	50	2000	→	FSS0507	FCD0585	FCD0585/1	FCS0585/2
SENDA 50 SR	50	2001	→	FSS0507	FCD0585	FCD0585/1	FCS0585/2
SENDA 50 R RACER	50	2002	→	FSS0507	FCD0585	FCD0585/1	FCS0585/2
SENDA 50 SM DRT	50	2002	→	FSS0507	FCD0585	FCD0585/1	FCS0585/2
SENDA 50 SM RACER	50	2002	→	FSS0507	FCD0585	FCD0585/1	FCS0585/2
SENDA 50 R DRD	50	2003	→ 2004	FSS0507	FCD0585	FCD0585/1	FCS0585/2
SENDA 50 SM DRD BLACK EDITION	50	2003	→	FSS0507	FCD0585	FCD0585/1	FCS0585/2
SENDA 50 SM DRD RACING	50	2003	→ 2004	FSS0507	FCD0585	FCD0585/1	FCS0585/2
SENDA 50 SM DRD RACING LTD	50	2005	→	FSS0507	FCD0585	FCD0585/1	FCS0585/2
TRICAMPEONA 50 7 C-4	50		→	FCD0553			
GPR 80 CUP	80	2004	→	FSS0507	FCD0585	FCD0585/1	FCS0585/2

DUCATI

MONSTER 400	400	2000	→ 2008	FCD0665	FCD0665/1	FCS0665/2	FCS0665/3
MONSTER 400 DARK IE	400	2005	→	FCD0665	FCD0665/1	FCS0665/2	FCS0665/3
MONSTER 400	400	1995	→ 1999	FCD0568		FCS0568/2	
SUPERSPORT 400	400	1993	→ 1997	FCD0568		FCS0568/2	
550 SUPERMONO	550	1992	→	FCD0620		FCS0620/2	
MONSTER 600	600	1998	→ 1999	FCD0665	FCD0665/1	FCS0665/2	FCS0665/3
MONSTER 600 DARK	600	1998	→	FCD0665	FCD0665/1	FCS0665/2	FCS0665/3
MONSTER 600 CITY - CITY DARK -DARK	600	1999	→	FCD0665	FCD0665/1	FCS0665/2	FCS0665/3
MONSTER 600	600	2000	→ 2001	FCD0665	FCD0665/1	FCS0665/2	FCS0665/3
MONSTER 600	600	1993	→ 1997	FCD0568		FCS0568/2	
SUPERSPORT 600	600	1991	→ 1997	FCD0568		FCS0568/2	
MONSTER 620 IE	620	2002	→ 2003	FCD0665	FCD0665/1	FCS0665/2	FCS0665/3
MONSTER 620 (6 marce)	620	2004	→	FCD0720		FCS0720/2	
MONSTER 620 (5 marce - single disk)	620	2004	→	FCD0665	FCD0665/1	FCS0665/2	FCS0665/3
MONSTER 620	620	2005	→ 2006	FCD0720		FCS0720/2	
MONSTER 620 DARK	620	2005	→ 2006	FCD0720		FCS0720/2	
MONSTER 620 DARK (single disk)	620	2005	→	FCD0720		FCS0720/2	
MULTISTRADA 620	620	2006	→	FCD0720		FCS0720/2	
MULTISTRADA 620 DARK	620	2006	→	FCD0720		FCS0720/2	
SPORT 620	620	2003	→	FCD0665	FCD0665/1	FCS0665/2	FCS0665/3
MONSTER 695	695	2007	→ 2012	FCD0720		FCS0720/2	
MONSTER 696	700	2008	→ 2013	FCD0720		FCS0720/2	
748 BIPOSTO - SP	748	1995	→ 2001	FCD0671		FCS0671/2	
748 RACING (con antisaltellamento)	748	1998	→ 1999	FCD0669		FCS0669/2	
748 SPS	748	1998	→ 1999	FCD0671		FCS0671/2	
748 RS (con antisaltellamento)	748	2000	→ 2001	FCD0669		FCS0669/2	
748 BIPOSTO	748	2001	→	FCD0672		FCS0672/2	
748 TESTA BASSA	748	2001	→	FCD0671		FCS0671/2	

2006

FERODO
RACING
Updated on November 2020

FCDXXXX
FCDXXXX/1
FCSXXXX/2
FCSXXXX/3

STANDARD
HIGH PERFORMANCE
STANDARD
HIGH PERFORMANCE

FRICITION PLATES ONLY
FRICITION PLATES ONLY
FRICITION PLATES + STEEL PLATES
FRICITION PLATES + STEEL PLATES



KIT RANGE



STANDARD HIGH PERFORMANCE



STANDARD HIGH PERFORMANCE

...DUCATI

748	748	2002	→	FCD0671		FCS0671/2	
748 S	748	2000	→ 2002	FCD0671		FCS0671/2	
749 (748cc)	748	2003	→ 2006	FCD0672		FCS0672/2	
749 S (748cc)	748	2003	→ 2006	FCD0672		FCS0672/2	
749 DARK (748cc)	748	2004	→ 2006	FCD0672		FCS0672/2	
749 R (748cc)	748	2004	→ 2006	FCD0669		FCS0669/2	
MONSTER 750	750	1998	→ 2001	FCD0665	FCD0665/1	FCS0665/2	FCS0665/3
MONSTER 750 CITY - CITY DARK	750	1999	→	FCD0665	FCD0665/1	FCS0665/2	FCS0665/3
MONSTER 750 IE	750	2002	→	FCD0665	FCD0665/1	FCS0665/2	FCS0665/3
MONSTER 750	750	1996	→ 1997	FCD0568		FCS0568/2	
SPORT 750	750	2000	→ 2002	FCD0665	FCD0665/1	FCS0665/2	FCS0665/3
SUPERSPORT 750	750	1999	→	FCD0665	FCD0665/1	FCS0665/2	FCS0665/3
SUPERSPORT 750 IE	750	2000	→ 2002	FCD0665	FCD0665/1	FCS0665/2	FCS0665/3
SUPERSPORT 750	750	1991	→ 1997	FCD0568		FCS0568/2	
MONSTER 795	795	2013	→	FCD0720		FCS0720/2	
MONSTER 797	797	2017	→ 2019			FCS1323/2	
MONSTER 797 PLUS	797	2017	→ 2019	FCD1323		FCS1323/2	
HYPERMOTARD 796 (800cc)	800	2010	→ 2012	FCD0720		FCS0720/2	
MONSTER 800	800	2003	→ 2004	FCD0665	FCD0665/1	FCS0665/2	FCS0665/3
MONSTER 800 S2R	800	2005	→ 2007	FCD0720		FCS0720/2	
MONSTER 800 S2R DARK	800	2005	→ 2006	FCD0720		FCS0720/2	
MONSTER 796 (800cc)	800	2011	→ 2014	FCD0720		FCS0720/2	
SCRAMBLER 800 CLASSIC	800	2015	→ 2019	FCD1323		FCS1323/2	
SCRAMBLER 800 ENDURO	800	2015	→	FCD1323		FCS1323/2	
SCRAMBLER 800 FULL THROTTLE	800	2015	→ 2019	FCD1323		FCS1323/2	
SCRAMBLER 800 ICON	800	2015	→ 2019	FCD1323		FCS1323/2	
SCRAMBLER 800 URBAN ENDURO	800	2015	→ 2016	FCD1323		FCS1323/2	
SCRAMBLER 800 FLAT TRACK PRO	800	2016	→	FCD1323		FCS1323/2	
SCRAMBLER 800 CAFE RACER	800	2017	→ 2019	FCD1323		FCS1323/2	
SCRAMBLER 800 DESERT SLED	800	2017	→ 2019	FCD1323		FCS1323/2	
SCRAMBLER 800 MACH 2.0	800	2018	→	FCD1323		FCS1323/2	
SCRAMBLER 800 STREET CLASSIC	800	2018	→	FCD1323		FCS1323/2	
SPORT 800	800	2003	→	FCD0665	FCD0665/1	FCS0665/2	FCS0665/3
SUPERSPORT 800	800	2003	→ 2005	FCD0665	FCD0665/1	FCS0665/2	FCS0665/3
HYPERMOTARD 821	821	2013	→ 2015	FCD1323		FCS1323/2	
HYPERMOTARD 821 HYPERSTRADA	821	2013	→ 2015	FCD1323		FCS1323/2	
HYPERMOTARD 821 LOW SEAT	821	2015	→	FCD1323		FCS1323/2	
MONSTER 821	821	2014	→ 2016	FCD1323		FCS1323/2	
MONSTER 821 DARK	821	2015	→ 2016	FCD1323		FCS1323/2	
MONSTER 821	821	2017	→ 2019	FCD1322	FCD1322/1	FCS1322/2	FCS1322/3
MONSTER 821 DARK	821	2017	→	FCD1322	FCD1322/1	FCS1322/2	FCS1322/3
EVO CORSE SE 848	848	2012	→		FCD0714/1		FCS0714/3
STREETFIGHTER 848	848	2012	→		FCD0714/1		FCS0714/3
STREETFIGHTER 848 S	848	2012	→		FCD0714/1		FCS0714/3
STREETFIGHTER 848	848	2013	→ 2015		FCD0714/1		FCS0714/3
SUPERBIKE 848 EVO CORSE SE-EVO-USA	848	2013	→		FCD0714/1		FCS0714/3
848	850	2008	→ 2010		FCD0714/1		FCS0714/3
EVO 848	850	2011	→ 2012		FCD0714/1		FCS0714/3
SUPERBIKE 848 EVO CORSE-EVO -HAYDEN-USA	850	2008	→ 2012		FCD0714/1		FCS0714/3
851 all models	851	1991	→ 1992	FCD0669		FCS0669/2	
888 all models	888	1993	→ 1995	FCD0669		FCS0669/2	
888 SUPERBIKE STRADA	888	1994	→ 1995	FCD0669		FCS0669/2	
PANIGALE 899 ABS - USA	899	2014	→		FCD0714/1		FCS0714/3
MH 900	900	2001	→ 2002	FCD0671		FCS0671/2	
MONSTER 900	900	1993	→ 1999	FCD0671		FCS0671/2	
MONSTER 900 SPECIAL	900	1998	→	FCD0671		FCS0671/2	
MONSTER 900 CROMO	900	1998	→ 1999	FCD0671		FCS0671/2	
MONSTER 900 CITY - CITY DARK	900	1999	→	FCD0671		FCS0671/2	
MONSTER 900 IE	900	2002	→	FCD0672		FCS0672/2	
MONSTER 900 IE	900	2000	→ 2001	FCD0671		FCS0671/2	
SPORT 900	900	2002	→	FCD0671		FCS0671/2	
SUPERSPORT 900 SUPERLIGHT	900	1991	→ 1997	FCD0671		FCS0671/2	
SUPERSPORT 900	900	1998	→ 1999	FCD0671		FCS0671/2	
SUPERSPORT 900 F.E.	900	1998	→	FCD0671		FCS0671/2	
SUPERSPORT 900 IE	900	2000	→ 2002	FCD0671		FCS0671/2	
907 IE	907	1990	→ 1993	FCD0669		FCS0669/2	
ST4 916	916	1999	→ 2001	FCD0671		FCS0671/2	
916 BIPOSTO SENNA	916	1994	→ 1998	FCD0671		FCS0671/2	
916 SP	916	1994	→ 1996	FCD0662		FCS0662/2	
MONSTER 916 S4	916	2001	→ 2002	FCD0671		FCS0671/2	
MONSTER 916 S4 FOGGY	916	2002	→	FCD0671		FCS0671/2	
ST4 916	916	2002	→ 2003	FCD0672		FCS0672/2	
SUPERSPORT 936	936	2017	→ 2019	FCD1322	FCD1322/1	FCS1322/2	FCS1322/3
SUPERSPORT 936 S	936	2017	→ 2019	FCD1322	FCD1322/1	FCS1322/2	FCS1322/3
HYPERMOTARD 939	939	2016	→ 2018	FCD1322	FCD1322/1	FCS1322/2	FCS1322/3
HYPERMOTARD 939 SP - SP U	939	2016	→ 2018	FCD1322	FCD1322/1	FCS1322/2	FCS1322/3

FCDXXXX STANDARD FRICTION PLATES ONLY
 FCDXXXX/1 HIGH PERFORMANCE FRICTION PLATES ONLY
 FCSXXXX/2 STANDARD FRICTION PLATES + STEEL PLATES
 FCSXXXX/3 HIGH PERFORMANCE FRICTION PLATES + STEEL PLATES



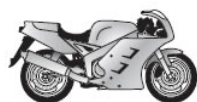

KIT RANGE



STANDARD
HIGH PERFORMANCE



STANDARD
HIGH PERFORMANCE

...DUCATI

ST2 944	944	1997	→	2001	FCD0671		FCS0671/2
ST2 944	944	2002	→	2003	FCD0672		FCS0672/2
MULTISTRADA 950	950	2017	→	2018	FCD1322	FCD1322/1	FCS1322/2 FCS1322/3
916 SPS - SPS I/II/III	996	1997	→	2000	FCD0662		FCS0662/2
RACING 916 (con antisaltellamento)	996	1997	→	1998	FCD0669		FCS0669/2
996	996	1999	→	2001	FCD0671		FCS0671/2
996 RS (con antisaltellamento)	996	2000	→	2001	FCD0669		FCS0669/2
996 R	996	2001	→		FCD0662		FCS0662/2
996 S	996	2001	→		FCD0662		FCS0662/2
MONSTER 996 S4R	996	2003	→	2006	FCD0672		FCS0672/2
ST4S 996	996	2001	→		FCD0671		FCS0671/2
ST4S 996	996	2002	→	2004	FCD0672		FCS0672/2
ST4S 996 ABS	996	2003	→	2004	FCD0672		FCS0672/2
ST4S 996	996	2005	→			FCD0714/1	FCS0714/3
ST4S 996 ABS	996	2005	→			FCD0714/1	FCS0714/3
998	998	2002	→	2003	FCD0671		FCS0671/2
998 R	998	2002	→		FCD0662		FCS0662/2
998 RS (con antisaltellamento)	998	2002	→	2003	FCD0669		FCS0669/2
998 S BAYLISS - BOSTROM	998	2002	→		FCD0671		FCS0671/2
998 MATRIX	998	2003	→	2004	FCD0671		FCS0671/2
999	998	2003	→	2006	FCD0672		FCS0672/2
999 R	998	2003	→	2004	FCD0662		FCS0662/2
999 S	998	2003	→	2004	FCD0662		FCS0662/2
999 S FINAL EDITION	998	2004	→		FCD0672		FCS0672/2
999 RS (con antisaltellamento)	998	2004	→	2005	FCD0669		FCS0669/2
999 S	998	2005	→	2006	FCD0672		FCS0672/2
999 R	998	2005	→	2006	FCD0672		FCS0672/2
DESMOSEDICI 1000 RR	1000	2008	→		FCD0669		FCS0669/2
GT 1000	1000	2007	→	2010		FCD0714/1	FCS0714/3
GT 1000 TOURING	1000	2009	→			FCD0714/1	FCS0714/3
MONSTER 1000	1000	2003	→	2005	FCD0672		FCS0672/2
MONSTER 1000 S	1000	2005	→		FCD0672		FCS0672/2
MONSTER 1000 S2R	1000	2006	→	2008	FCD0672		FCS0672/2
MONSTER 1000 S4RS	1000	2006	→	2008	FCD0672		FCS0672/2
MONSTER 1000 S4R	1000	2007	→	2008	FCD0672		FCS0672/2
MONSTER 1000 S4RS TRICOLORE	1000	2008	→		FCD0672		FCS0672/2
MULTISTRADA 1000	1000	2003	→	2006	FCD0672		FCS0672/2
MULTISTRADA 1000 DS	1000	2005	→		FCD0672		FCS0672/2
MULTISTRADA 1000 DS S	1000	2005	→		FCD0672		FCS0672/2
MULTISTRADA 1000 S	1000	2006	→		FCD0672		FCS0672/2
PAUL SMART 1000 L.E.	1000	2006	→		FCD0672		FCS0672/2
SPORT 1000	1000	2006	→		FCD0672		FCS0672/2
SPORT 1000 MONOPOSTO JPN	1000	2007	→		FCD0672		FCS0672/2
SPORT 1000	1000	2007	→	2008		FCD0714/1	FCS0714/3
SPORT 1000 S	1000	2007	→	2009		FCD0714/1	FCS0714/3
SPORT 1000 CLASSIC GT	1000	2007	→	2010		FCD0714/1	FCS0714/3
ST3 1000	1000	2004	→		FCD0672		FCS0672/2
ST3 1000	1000	2005	→	2007		FCD0714/1	FCS0714/3
ST3 1000 ABS	1000	2006	→	2007		FCD0714/1	FCS0714/3
SUPERSPORT 1000	1000	2003	→	2006	FCD0672		FCS0672/2
1098	1100	2007	→	2008	FCD0717		FCS0717/2
1098 S	1100	2007	→	2008	FCD0717		FCS0717/2
1098 S TRICOLORE	1100	2007	→	2008	FCD0717		FCS0717/2
HYPERMOTARD 1100	1100	2008	→	2009	FCD0717		FCS0717/2
HYPERMOTARD 1100 S	1100	2008	→	2009	FCD0717		FCS0717/2
HYPERMOTARD 1100 EVO SP	1100	2010	→	2012	FCD0715		FCS0715/2
HYPERMOTARD 1100 EVO	1100	2011	→	2012	FCD0715		FCS0715/2
MONSTER 1100 - ABS	1100	2009	→	2010	FCD0715		FCS0715/2
MONSTER 1100 S	1100	2009	→	2010	FCD0715		FCS0715/2
MONSTER 1100 S ABS	1100	2010	→		FCD0715		FCS0715/2
MONSTER 1100 EVO - EVO ABS	1100	2012	→	2013	FCD1322	FCD1322/1	FCS1322/2 FCS1322/3
MONSTER 1100 EVO	1100	2012	→	2013	FCD1322	FCD1322/1	FCS1322/2 FCS1322/3
MONSTER 1100 DIESEL	1100	2013	→		FCD1322	FCD1322/1	FCS1322/2 FCS1322/3
MONSTER 1100 EVO ANNIVERSARY	1100	2013	→		FCD1322	FCD1322/1	FCS1322/2 FCS1322/3
MULTISTRADA 1100	1100	2007	→	2009		FCD0714/1	FCS0714/3
MULTISTRADA 1100 S	1100	2007	→	2009		FCD0714/1	FCS0714/3
PANIGALE 1100 V4	1100	2018	→	2019		FCD1321/1	FCS1321/3
PANIGALE 1100 V4 S	1100	2018	→	2019		FCD1321/1	FCS1321/3
PANIGALE 1100 V4 SPECIALE	1100	2018	→	2019		FCD1321/1	FCS1321/3
SCRAMBLER 1100	1100	2018	→		FCD1322	FCD1322/1	FCS1322/2 FCS1322/3
SCRAMBLER 1100 SPECIAL	1100	2018	→	2019	FCD1322	FCD1322/1	FCS1322/2 FCS1322/3
SCRAMBLER 1100 SPORT	1100	2018	→	2019	FCD1322	FCD1322/1	FCS1322/2 FCS1322/3
STREETFIGHTER 1100	1100	2010	→	2011	FCD0715		FCS0715/2
STREETFIGHTER 1100 S	1100	2010	→	2012	FCD0715		FCS0715/2
1098 R	1200	2008	→	2009	FCD0669		FCS0669/2
1098 R BAYLISS	1200	2009	→		FCD0669		FCS0669/2

DUCATI

2008

FERODO
RACING
Updated on November 2020

FCDXXX
FCDXXX/1
FCSXXX/2
FCSXXX/3

STANDARD
HIGH PERFORMANCE
STANDARD
HIGH PERFORMANCE

FRICITION PLATES ONLY
FRICITION PLATES ONLY
FRICITION PLATES + STEEL PLATES
FRICITION PLATES + STEEL PLATES

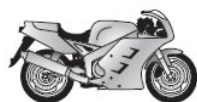

KIT RANGE



STANDARD

HIGH PERFORMANCE



STANDARD

HIGH PERFORMANCE

...DUCATI

					STANDARD	HIGH PERFORMANCE	STANDARD	HIGH PERFORMANCE
1198	1200	2009	→	2011	FCD0715		FCS0715/2	
1198 S	1200	2009	→	2010	FCD0715		FCS0715/2	
1198 R CORSE	1200	2010	→		FCD0669		FCS0669/2	
1198 S CORSE	1200	2010	→		FCD0715		FCS0715/2	
1198 SP	1200	2011	→		FCD0669		FCS0669/2	
DIAVEL 1200	1200	2011	→	2013	FCD1322	FCD1322/1	FCS1322/2	FCS1322/3
DIAVEL 1200 CARBON	1200	2011	→	2013	FCD1322	FCD1322/1	FCS1322/2	FCS1322/3
DIAVEL 1200 BRA	1200	2012	→	2014	FCD1322	FCD1322/1	FCS1322/2	FCS1322/3
DIAVEL 1200 CARBON BRA	1200	2012	→	2014	FCD1322	FCD1322/1	FCS1322/2	FCS1322/3
DIAVEL 1200 AMG	1200	2013	→		FCD1322	FCD1322/1	FCS1322/2	FCS1322/3
DIAVEL 1200 CROMO	1200	2013	→		FCD1322	FCD1322/1	FCS1322/2	FCS1322/3
DIAVEL 1200 STRADA	1200	2013	→	2014	FCD1322	FCD1322/1	FCS1322/2	FCS1322/3
DIAVEL 1200 WHITE STRIPE	1200	2013	→	2014	FCD1322	FCD1322/1	FCS1322/2	FCS1322/3
DIAVEL 1200 CARBON FL	1200	2015	→		FCD1322	FCD1322/1	FCS1322/2	FCS1322/3
MONSTER 1200	1200	2014	→	2019	FCD1322	FCD1322/1	FCS1322/2	FCS1322/3
MONSTER 1200 S	1200	2014	→	2019	FCD1322	FCD1322/1	FCS1322/2	FCS1322/3
MONSTER 1200 R	1200	2016	→	2019	FCD1322	FCD1322/1	FCS1322/2	FCS1322/3
MULTISTRADA 1200 - ABS	1200	2010	→	2017	FCD1322	FCD1322/1	FCS1322/2	FCS1322/3
MULTISTRADA 1200 S SPORT	1200	2010	→	2012	FCD1322	FCD1322/1	FCS1322/2	FCS1322/3
MULTISTRADA 1200 S TOURING	1200	2010	→	2017	FCD1322	FCD1322/1	FCS1322/2	FCS1322/3
MULTISTRADA 1200 S PIKES PEAK	1200	2011	→	2017	FCD1322	FCD1322/1	FCS1322/2	FCS1322/3
MULTISTRADA 1200 S GT	1200	2013	→	2014	FCD1322	FCD1322/1	FCS1322/2	FCS1322/3
MULTISTRADA 1200 S TOURING D-AIR	1200	2014	→		FCD1322	FCD1322/1	FCS1322/2	FCS1322/3
MULTISTRADA 1200 S	1200	2015	→	2017	FCD1322	FCD1322/1	FCS1322/2	FCS1322/3
MULTISTRADA 1200 S D AIR	1200	2015	→	2017	FCD1322	FCD1322/1	FCS1322/2	FCS1322/3
MULTISTRADA 1200 TOURING	1200	2015	→	2017	FCD1322	FCD1322/1	FCS1322/2	FCS1322/3
MULTISTRADA 1200 ENDURO	1200	2016	→	2018	FCD1322	FCD1322/1	FCS1322/2	FCS1322/3
MULTISTRADA 1200 ENDURO TOURING	1200	2016	→	2018	FCD1322	FCD1322/1	FCS1322/2	FCS1322/3
MULTISTRADA 1200 SPORT PACK	1200	2017	→	2018	FCD1322	FCD1322/1	FCS1322/2	FCS1322/3
MULTISTRADA 1200 ENDURO PRO	1200	2018	→		FCD1322	FCD1322/1	FCS1322/2	FCS1322/3
PANIGALE 1199 - ABS	1200	2012	→	2014		FCD0727/1		FCS0727/3
PANIGALE 1199 S - S ABS	1200	2012	→	2014		FCD0727/1		FCS0727/3
PANIGALE 1199 TRICOLORE	1200	2012	→	2014		FCD0727/1		FCS0727/3
PANIGALE 1199 R	1200	2013	→	2014	FCD1322	FCD1322/1	FCS1322/2	FCS1322/3
MULTISTRADA 1262 S	1262	2018	→	2019	FCD1322	FCD1322/1	FCS1322/2	FCS1322/3
MULTISTRADA 1262 S PIKES PEAK	1262	2018	→	2019	FCD1322	FCD1322/1	FCS1322/2	FCS1322/3
MULTISTRADA 1262 S TOURING	1262	2018	→	2019	FCD1322	FCD1322/1	FCS1322/2	FCS1322/3
MULTISTRADA 1262 TOURING	1262	2018	→	2019	FCD1322	FCD1322/1	FCS1322/2	FCS1322/3
MULTISTRADA 1262 S D-AIR	1262	2019	→		FCD1322	FCD1322/1	FCS1322/2	FCS1322/3
XDIAVEL 1262	1262	2016	→	2019	FCD1322	FCD1322/1	FCS1322/2	FCS1322/3
XDIAVEL 1262 S	1262	2016	→	2019	FCD1322	FCD1322/1	FCS1322/2	FCS1322/3
XDIAVEL 1262 SPORT PACK	1262	2017	→		FCD1322	FCD1322/1	FCS1322/2	FCS1322/3
PANIGALE 1299 SUPER LEGGERA RACING	1299	2017	→		FCD1320	FCD1320/1		
PANIGALE 1299 R FINAL EDITION 1285cc	1299	2018	→		FCD1320	FCD1320/1		

FANTIC

OASIS 50 .1	50	1986	→	1987	FCD0619	FCD0619/1		
OASIS 50 .1 RALLY	50	1986	→		FCD0619	FCD0619/1		
OASIS 50 .1 K.S.	50	1987	→		FCD0619	FCD0619/1		
OASIS 50 .1 KICK	50	1987	→		FCD0619	FCD0619/1		
RAIDER 50	50	1981	→	1985	FCD0619	FCD0619/1		
RAIDER 50 .1	50	1986	→		FCD0619	FCD0619/1		
TRIAL 50 I SERIE (mozzi centrali)	50		→	1983	FCD0587			
TRIAL 50 II mozzi conici	50	1983	→	1984	FCD0587			
TRIAL 50 .1 (FM.268)	50	1986	→		FCD0619	FCD0619/1		
TRIAL 50 .1 H2O	50	1987	→		FCD0619	FCD0619/1		
TRIAL 50 JUNIOR	50	1987	→		FCD0619	FCD0619/1		
TRIAL 50 .5	50	1989	→		FCD0619	FCD0619/1		
TRIAL 50 .7	50	1990	→		FCD0619	FCD0619/1		
TRIAL 50 .9	50	1991	→		FCD0619	FCD0619/1		
CABALLERO 125 REGOLARITA	125	1981	→	1984	FCD0541			
RAIDER 125	125		→	1984	FCD0530		FCS0530/2	
RAIDER 125 LC	125	1984	→		FCD0530		FCS0530/2	
SPORT 125	125		→	1984	FCD0530		FCS0530/2	
SPORT 125 MK II	125		→	1984	FCD0530		FCS0530/2	
SPORT 125 HP1 (FM.265)	125	1985	→		FCD0530		FCS0530/2	
SPORT 125 MK II (f.a.tel.1706338)	125	1985	→		FCD0530		FCS0530/2	
STRADA 125 (FM. 4000-A)	125	1983	→		FCD0530		FCS0530/2	
TRIAL 125 7 DAYS (mozzi conici)	125		→		FCD0541			
TRIAL 125 7 DAYS (mozzi centrali)	125		→		FCD0541			
TRIAL 125 I SERIE. (tEL. grig. m. cen)	125		→		FCD0541			
TRIAL 125 II SERIE (tel.rosso, m.cen)	125		→		FCD0541			
TRIAL 125 III SERIE (mozzi conici)	125		→		FCD0541			
TRIAL 125 PROFESSIONAL (FM.237)	125	1983	→	1984	FCD0530		FCS0530/2	
TRIAL 125 .1 Progress 2	125	1985	→	1986	FCD0660			

FCDXXXX
FCDXXXX/1
FCSXXXX/2
FCSXXXX/3

STANDARD
HIGH PERFORMANCE
STANDARD
HIGH PERFORMANCE

FRICITION PLATES ONLY
FRICITION PLATES ONLY
FRICITION PLATES + STEEL PLATES
FRICITION PLATES + STEEL PLATES

FERODO
RACING
Updated on November 2020

2009

FANTIC

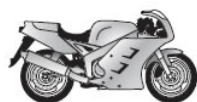

KIT RANGE



STANDARD
HIGH PERFORMANCE



STANDARD
HIGH PERFORMANCE

...FANTIC

TRIAL 125 .1 Progress 1	125	1987	→	1988	FCD0660		
TRIAL 125 .5	125	1989	→	1990	FCD0530		FCS0530/2
TRIAL 125 .9	125	1991	→		FCD0530		FCS0530/2
TRIAL 200 (FM. 350)	200	1978	→		FCD0541		
TRIAL 200	200	1985	→	1986	FCD0660		
TRIAL 200 Progress 1	200	1986	→		FCD0628		
TRIAL 201 Progress2	201	1986	→		FCD0628		
TRIAL 240 SEVEN DAYS (FM. 289)	240	1986	→		FCD0660		
TRIAL 240 (FM 363)	240	1987	→	1988	FCD0660		
TRIAL 241 PROFESSIONAL	241	1986	→		FCD0660		
K-ROO 250	250	1991	→	1992	FCD0660		
TRIAL 300 (FM. 403)	300	1984	→		FCD0660		
TRIAL 301 Progress 1 (FM. 266)	301	1985	→		FCD0660		
TRIAL 301 Progress 2	301	1986	→		FCD0660		
TRIAL 303 (FM 364)	303	1987	→	1988	FCD0660		
TRIAL 305	305	1989	→		FCD0660		
TRIAL 307	307	1990	→	1991	FCD0660		

GARELLI

ciclomotori 1 corpo elastico 1veloc.	1		→		FCD0589		
ciclomotori 1 disco avviamento	1		→		FCD0655		
GULP 50	50		→		FCD0549		
KL 50 SV	50		→		FCD0549		
NOI 50 (ruota lega fondermonte)	50		→		FCD0532		
NOI 50 (ruota lega grimeca)	50		→		FCD0532		
NOI 50 (ruota raggi)	50		→		FCD0532		
NOI 50 MATIC	50		→		FCD0532		
TIGER 50 XLE	50	1986	→		FCD0588	FCD0588/1	
VIP 50 ruota lega (fondermonte)	50		→		FCD0532		
VIP 50 (ruota lega grimeca)	50		→		FCD0532		
VIP 50 (ruota raggi)	50		→		FCD0532		
GTA 125	125	1986	→	1987	FCD0573		
GTA 125	125	1987	→		FCD0573		
TIGER 125 XR	125		→		FCD0573		
TIGER 125 XRD	125		→		FCD0573		
TIGER 125	125		→		FCD0541		
TIGER 125 XLE	125	1986	→		FCD0573		
TSR 125 ACQUA SM	125		→		FCD0573		
TSR 125	125		→		FCD0541		
TSR 125 SELF MIX	125		→		FCD0541		
TRIAL 320	320		→	1985	FCD0573		

GAS GAS

EC 125 MC	125	1997	→	2007		FCD0739/1		FCS0739/3
EC 125 MX	125	2002	→	2007		FCD0739/1		FCS0739/3
EC 125 SM	125	2002	→	2007		FCD0739/1		FCS0739/3
EC 125 SIXDAYS	125	2010	→			FCD0739/1		FCS0739/3
HALLEY 125 EH-SM	125	2009	→			FCD0739/1		FCS0739/3
PAMPERA 125	125	1996	→	2001		FCD0561/1		FCS0561/3
TT 125	125	1995	→			FCD0561/1		FCS0561/3
EC 200 2T	200	1999	→		FCD0753			
EC 200 2T	200	2000	→	2011	FCD0753			
EC 200 MX	200	2002	→	2010	FCD0753			
EC 200 SM	200	2002	→	2007	FCD0753			
EC 200 SIXDAYS	200	2010	→		FCD0753			
EC 200 RACING 2T	200	2015	→		FCD0753			
PAMPERA 200	200	1992	→	2001		FCD0561/1		FCS0561/3
TX 200	200	1997	→	1999		FCD0561/1		FCS0561/3
EC 250 2T	250	1997	→	2011	FCD0753			
EC 250 MX	250	2001	→	2007	FCD0753			
EC 250 SM	250	2002	→	2007	FCD0753			
EC F 250 4T	250	2010	→	2015	FCD0251	FCD0251/1	FCS0251/2	FCS0251/3
EC 250 SIXDAYS	250	2010	→		FCD0753			
EC 250 RACING 2T	250	2012	→	2015	FCD0753			
MC 250	250	1997	→	1999	FCD0753			
MC 250	250	2000	→		FCD0753			
MC 250	250	2001	→	2009	FCD0753			
PAMPERA 250	250	2000	→	2001		FCD0561/1		FCS0561/3
SM 250	250	2002	→		FCD0753			
PAMPERA 280	280	2000	→	2001		FCD0561/1		FCS0561/3
TXT 280	280	1992	→	1999		FCD0561/1		FCS0561/3
EC 300 2T	300	1998	→	2000	FCD0753			
EC 300 2T	300	2001	→	2011	FCD0753			
EC 300 SM	300	2002	→	2007	FCD0753			

20010

FERODO

RACING

Updated on November 2020

FCDXXXX
FCDXXXX/1
FCSXXXX/2
FCSXXXX/3

STANDARD
HIGH PERFORMANCE
STANDARD
HIGH PERFORMANCE

FRICTION PLATES ONLY
FRICTION PLATES ONLY
FRICTION PLATES + STEEL PLATES
FRICTION PLATES + STEEL PLATES

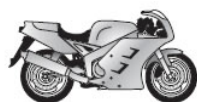

KIT RANGE



HIGH PERFORMANCE



HIGH PERFORMANCE

...GAS GAS

				STANDARD	HIGH PERFORMANCE	STANDARD	HIGH PERFORMANCE
EC 300 MC	300	2002 → 2010		FCD0753			
EC 300 SIXDAYS	300	2010 →		FCD0753			
EC 300 RACING 2T	300	2012 → 2015		FCD0753			
EC F 300 4T	300	2013 → 2015		FCD0753			
MC 300	300	1996 → 2009		FCD0753			
TXT 320	320	1992 → 1999			FCD0561/1		FCS0561/3
EC 400 FSE	400	2003 → 2004		FCD0753			
FSE 400 SM 4T	400	2002 → 2007		FCD0753			
EC 450 FSE	450	2005 → 2009		FCD0753			
EC 450 FSR	450	2005 → 2009		FCD0753			
EC F 450 4T	450	2013 → 2015		FCD0678	FCD0678/1		
FSR 450 SM	450	2008 →		FCD0753			
PAMPERA 450	450	2007 → 2008		FCD0753			
EC 510 FSE/FSR	510	2005 → 2008		FCD0753			
SM 515 FSR	515	2007 → 2008		FCD0753			

GILERA

CBA 50	50	→		FCD0604			
CBA variatore 50	50	1986 →		FCD0579			
GSM 50 motore Morini 6M	50	→	FSS0513	FCD0509			
R1 50	50	1990 →		FCD0664			
RC 50	50	→		FCD0664			
RC 50 TOP RALLY	50	1990 →	FSS0513	FCD0509			
SUPERMOTARD 50	50	2001 →	FSS0513	FCD0509			
TREND 50 massette avviamento	50	1989 →		FCD0604			
TREND 50 massette frizione	50	1989 →		FCD0535			
TREND variatore 50 massette avviamento	50	1989 →		FCD0579			
ARIZONA 125	125	1983 →		FCD0510		FCS0510/2	
CRONO 125	125	1991 →		FCD0510		FCS0510/2	
ER 125	125	1987 →		FCD0510		FCS0510/2	
KK 125 APTS	125	1987 →		FCD0510		FCS0510/2	
KZ 125	125	1986 →		FCD0510		FCS0510/2	
KZ 125 ENDURANCE	125	1988 →		FCD0510		FCS0510/2	
MX-1 125	125	1988 → 1989		FCD0510		FCS0510/2	
MXR 125	125	1990 →		FCD0510		FCS0510/2	
RC 125 RALLY	125	1987 → 1988		FCD0510		FCS0510/2	
RRT 125 NEBRASKA	125	1987 →		FCD0510		FCS0510/2	
RRT 125 NEBRASKA (ruote tubles)	125	1987 →		FCD0510		FCS0510/2	
RTX 125	125	→		FCD0510		FCS0510/2	
RV 125	125	1983 →		FCD0510		FCS0510/2	
RX 125	125	1984 →		FCD0510		FCS0510/2	
RX 125 ARIZONA HAWK	125	1986 →		FCD0510		FCS0510/2	
SP 01 125	125	1989 →		FCD0510		FCS0510/2	
SP 02 125	125	1990 →		FCD0510		FCS0510/2	
XR1 125	125	1988 →		FCD0510		FCS0510/2	
XR2 125	125	1989 →		FCD0510		FCS0510/2	
ER 200	200	1987 →		FCD0510		FCS0510/2	
FAST BIKE 200	200	1987 →		FCD0510		FCS0510/2	
RTX 200	200	1986 →		FCD0510		FCS0510/2	
RV 200	200	1985 → 1986		FCD0510		FCS0510/2	
RV 200 ES	200	1987 →		FCD0510		FCS0510/2	
RX 200	200	1985 →		FCD0510		FCS0510/2	
RX 200 ARIZONA HAWK	200	1986 →		FCD0510		FCS0510/2	
NGR 250	250	1985 →		FCD0506			
RC 250 RALLY	250	1987 →		FCD0506			
RX 250 ARIZONA RALLY	250	1986 →		FCD0506			
DAKOTA 350	350	1986 →		FCD0623		FCS0623/2	
XRT 350	350	1988 →		FCD0623		FCS0623/2	
DAKOTA 500	500	1987 →		FCD0623		FCS0623/2	
ER 500	500	1987 →		FCD0623		FCS0623/2	
RC 600	600	1989 → 1990		FCD0168			
RC 600 NORTHWEST	600	1990 →		FCD0168			
RC 600 TOP RALLY	600	1990 →		FCD0168			
RC 600 R	600	1991 →		FCD0168			
RC 600	600	1991 →		FCD0168			
XRT 600	600	1988 →		FCD0168			

HONDA

C 50	50	1975 → 1978	FSS0125	FCD0176			
C 50	50	1979 → 1981	FSS0125	FCD0107			
C 50	50	1982 → 2002		FCD0107			
CB 50 J all models	50	1981 →	FSS0402	FCD0109			
CB 50 DREAM	50	1997 → 1998		FCD0109			
CD 50 BENTLEY S	50	1996 → 1999		FCD0192			

FCDXXXX STANDARD FRICTION PLATES ONLY
 FCDXXXX/1 HIGH PERFORMANCE FRICTION PLATES ONLY
 FCSXXXX/2 STANDARD FRICTION PLATES + STEEL PLATES
 FCSXXXX/3 HIGH PERFORMANCE FRICTION PLATES + STEEL PLATES

FERODO
 RACING
 Updated on November 2020

2011

HONDA

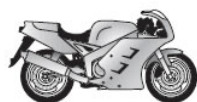

KIT RANGE



STANDARD
HIGH PERFORMANCE



STANDARD
HIGH PERFORMANCE

...HONDA

Model	Year	Year Range	FSS Code	Kit	Performance	Kit	Performance
CF 50	50	1977 → 1978	FSS0125	FCD0107			
CL 50 BENTLEY	50	1997 → 1999		FCD0192			
CR 50 R	50	1984 → 1985	FSS0402	FCD0110	FCD0110/1		
CRF 50	50	2004 → 2011		FCD0107			
CRM 50 R	50	1993 → 1996	FSS0402	FCD0109			
MB 50	50	1980 → 1982	FSS0402	FCD0109			
MBX 50 SD - SF	50	1983 → 1985	FSS0402	FCD0109			
MP 50 SOLO	50	2003 →		FCD0107			
MT 50	50	1980 → 1993	FSS0402	FCD0109			
MTX 50 S	50	1983 →	FSS0402	FCD0109			
NSR 50 F - S	50	1989 → 1995	FSS0402	FCD0109			
NSR 50 R	50	1997 → 2000	FSS0402	FCD0109			
NSR 50 V - X	50	1997 → 1999	FSS0402	FCD0110	FCD0110/1		
SS 50 ZK2	50	1975 → 1977		FCD0192			
SS 50 ZB2	50	1977 → 1980		FCD0192			
ST 50	50	1978 → 1993		FCD0107			
TLM 50 F	50	1985 →	FSS0115	FCD0109			
XR 50 R	50	2001 → 2003		FCD0107			
XR 50 MOTARD	50	2006 →		FCD0109			
XZ 50	50	2001 → 2002		FCD0109			
Z 50 all models	50	1979 → 1991	FSS0125	FCD0176			
CR 60 R	60	1985 → 1986	FSS0402	FCD0110	FCD0110/1		
C 70 all models	70	1975 → 1977		FCD0176			
C 70 all models	70	1978 → 1985	FSS0108	FCD0107			
CF 70 C	70	1977 → 1978	FSS0108	FCD0107			
CRF 70	70	2004 → 2012	FSS0108	FCD0107			
XR 70 R	70	1997 → 2003	FSS0108	FCD0107			
CRM 75 R	75	1989 → 1994	FSS0402	FCD0110	FCD0110/1		
NSR 75 NS-1	75	1992 → 2000	FSS0402	FCD0110	FCD0110/1		
XR 75	75	1975 → 1978	FSS0111	FCD0109			
XR 75	75	1979 →	FSS0111	FCD0109			
CR 80 R	80	1980 → 1981	FSS0402	FCD0110	FCD0110/1		
CR 80 R	80	1982 →	FSS0402	FCD0110	FCD0110/1		
CR 80 R	80	1983 →	FSS0406	FCD0110	FCD0110/1		
CR 80 R	80	1984 →	FSS0406	FCD0101		FCS0101/2	
CR 80 R	80	1985 → 2002	FSS0101	FCD0101		FCS0101/2	
CRF 80 F	80	2004 → 2012		FCD0109			
MBX 80 FWD	80	1983 → 1986	FSS0402	FCD0110	FCD0110/1		
MTX 80 all models	80	1983 → 1984	FSS0402	FCD0110	FCD0110/1		
NSR 80 R	80	1987 → 1999	FSS0402	FCD0110	FCD0110/1		
XR 80	80	1980 → 1984	FSS0111	FCD0109			
XR 80 R	80	1985 → 1988	FSS0102	FCD0109			
CR 85	85	2003 → 2007	FSS0101	FCD0101		FCS0101/2	
C 90	90	1975 → 1981		FCD0113			
C 90	90	1982 → 2003		FCD0107			
CB 100 N	100	1978 → 1980		FCD0101		FCS0101/2	
CRF 100 F	100	2004 →		FCD1119			
H 100	100	1984 → 1992	FSS0402	FCD0110	FCD0110/1		
SUPRA 100	100	1997 → 1998		FCD0110	FCD0110/1		
SUPRA 100	100	1999 →		FCD0110	FCD0110/1		
XL 100 all models	100	1978 → 1980		FCD0110	FCD0110/1		
XL 100 all models	100	1981 → 1982	FSS0111	FCD0110	FCD0110/1		
XR 100 R	100	1993 → 2003		FCD1119			
XR 100 MOTARD	100	2006 →		FCD0110	FCD0110/1		
XZ 100	100	2002 →		FCD0110	FCD0110/1		
CT 110	110	1980 → 2009		FCD0113			
ANF 125 INNOVA	125	2003 → 2011		FCD0189			
CA 125 REBEL	125	1995 → 1997		FCD0171	FCD0171/1		
CA 125 REBEL	125	1998 →		FCD0101		FCS0101/2	
CB 125 K1 - K5	125	1972 → 1976	FSS0117	FCD0101		FCS0101/2	
CB 125 K6 - S2	125	1976 → 1977	FSS0117	FCD0101		FCS0101/2	
CB 125 T	125	1978 →	FSS0117	FCD0101		FCS0101/2	
CB 125 J	125	1979 →	FSS0117	FCD0101		FCS0101/2	
CB 125 T2 - TA - TB	125	1979 →	FSS0117	FCD0101		FCS0101/2	
CB 125 RS	125	1983 →	FSS0117	FCD0101		FCS0101/2	
CB 125 TDJ	125	1987 → 1989		FCD0171	FCD0171/1		
CBF 125	125	2009 → 2012		FCD0101		FCS0101/2	
CBR 125 R	125	2004 → 2011		FCD0171	FCD0171/1		
CBR 125 R	125	2012 →		FCD0171	FCD0171/1		
CD 125	125	1978 →		FCD0101		FCS0101/2	
CG 125 all models	125	1977 → 1984	FSS0117	FCD0101		FCS0101/2	
CG 125	125	1985 → 2008	FSS0117	FCD0101		FCS0101/2	
CLR 125 CITY FLY	125	1998 → 2003		FCD0101		FCS0101/2	
CM 125	125	1982 → 1985	FSS0103	FCD0101		FCS0101/2	
CR 125 M2 - 3 - 4	125	1976 → 1978	FSS0308	FCD0178			
CR 125 R	125	1979 → 1980	FSS0115	FCD0161			

HONDA

20012

FERODO
RACING
Updated on November 2020

FCDXXX
FCDXXX/1
FCSXXX/2
FCSXXX/3

STANDARD
HIGH PERFORMANCE
STANDARD
HIGH PERFORMANCE

FRICTION PLATES ONLY
FRICTION PLATES ONLY
FRICTION PLATES + STEEL PLATES
FRICTION PLATES + STEEL PLATES



KIT RANGE

STANDARD
HIGH PERFORMANCESTANDARD
HIGH PERFORMANCE

...HONDA

					STANDARD	HIGH PERFORMANCE	STANDARD	HIGH PERFORMANCE
CR 125 R	125	1981 →	FSS0115	FCD0127	FCD0127/1			
CR 125 R	125	1982 →	FSS0115	FCD0157				
CR 125 R	125	1983 →		FCD1113				
CR 125 R	125	1984 →		FCD1113				
CR 125 R	125	1985 →		FCD0132				FCS0132/3
CR 125 R	125	1986 → 1994		FCD0136		FCS0136/2		
CR 125 R - E	125	1995 → 1999		FCD0136		FCS0136/2		
CR 125 R - E	125	2000 → 2003	FSS0123	FCD0151	FCD0151/1	FCS0151/2		FCS0151/3
CR 125 SUPERMOTARD	125	2000 →	FSS0123	FCD0151	FCD0151/1	FCS0151/2		FCS0151/3
CR 125 R - E	125	2004 →	FSS0123	FCD0151	FCD0151/1	FCS0151/2		FCS0151/3
CRM 125	125	1990 → 1999		FCD0115				
CT 125	125	1985 →	FSS0117	FCD0101		FCS0101/2		
LS 125 R	125	2000 →		FCD0171	FCD0171/1			
MBX 125	125	1984 → 1986	FSS0103	FCD0124				
MTX 125 R	125	1983 → 1995		FCD0124				
NS 125 F all models	125	1986 → 1987		FCD0111				
NSR 125	125	1988 →		FCD0115				
NSR 125 R - F	125	1989 → 2001		FCD0115				
NX 125 TRANSCITY	125	1989 → 1997		FCD0101		FCS0101/2		
TL 125	125	1976 →		FCD0101		FCS0101/2		
VT 125 C SHADOW	125	1999 → 2008		FCD0155				
XL 125	125	1978 →		FCD0101		FCS0101/2		
XL 125	125	1979 →		FCD0101		FCS0101/2		
XL 125	125	1980 → 1982	FSS0115	FCD0101		FCS0101/2		
XL 125 R	125	1984 → 1986	FSS0103	FCD0101		FCS0101/2		
XLR 125 R	125	1998 → 2001		FCD0101		FCS0101/2		
XLV 125 VARADERO	125	2001 → 2011		FCD0155				
XR 125 L	125	2003 → 2008	FSS0117	FCD0101		FCS0101/2		
CBR R 150	150	2000 → 2003		FCD0171	FCD0171/1			
CRF 150 R	150	2007 → 2013						FCS1118/3
CB 175 all models	175	1974 → 1976	FSS0102	FCD0153	FCD0153/1			
CD 175 all models	175	1971 → 1978	FSS0102	FCD0153	FCD0153/1			
CD 185 T	185	1978 →	FSS0103	FCD0101		FCS0101/2		
XL 185	185	1980 → 1981	FSS0117	FCD0101		FCS0101/2		
XL 185	185	1982 →		FCD0101		FCS0101/2		
CB 200 B - T	200	1976 → 1978	FSS0102	FCD0153	FCD0153/1			
CD 200 T	200	1979 → 1980	FSS0112	FCD0101		FCS0101/2		
CM 200 TA - TB	200	1979 → 1980	FSS0112	FCD0101		FCS0101/2		
CTX 200 A BUSHLANDER	200	2004 → 2005		FCD0101		FCS0101/2		
MTX 200 RWD	200	1983 → 1984		FCD0162				
MTX 200 RW	200	1985 → 1986		FCD0124				
TA 200 SHADOW	200	2002 → 2005		FCD0171	FCD0171/1			
TL 200	200	1976 → 1978		FCD0101		FCS0101/2		
TLR 200	200	1983 → 1987	FSS0103	FCD0101		FCS0101/2		
XR 200 R	200	1980 → 1983		FCD0101		FCS0101/2		
XR 200 R	200	1984 → 1985		FCD0124				
XR 200 R	200	1986 → 2002		FCD0101		FCS0101/2		
FTR 223 Y2/A2 (MCS4)	223	2000 → 2002		FCD0171	FCD0171/1			
CRF 230 EASY (rear disc)	230	2008 →	FSS0103	FCD0171	FCD0171/1			
CRF 230 M	230	2009 → 2015	FSS0103	FCD0171	FCD0171/1			
SL 230	230	1997 → 2001		FCD0171	FCD0171/1			
XL 230 (MC36)	230	2002 →		FCD0171	FCD0171/1			
AX 1 250	250	1989 → 1994		FCD0126	FCD0126/1	FCS0126/2		FCS0126/3
CB 250	250	1973 → 1975		FCD0168				
CB 250	250	1978 → 1982	FSS0301	FCD0102				
CB 250 RSA - RSD - RSE	250	1981 →	FSS0103	FCD0111				
CB 250 TWO FIFTY	250	1993 → 2005	FSS0112	FCD0127	FCD0127/1			
CB 250 FT HORNET	250	1996 → 2001		FCD1128				
CBF 250	250	2004 → 2006		FCD1129				
CBR 250 R HURRICANE	250	1986 →		FCD1128				
CBR 250 R HURRICANE	250	1987 →		FCD1128				
CBR 250 R - RR	250	1988 → 1994		FCD1128				
CBR 250 R	250	2011 → 2013		FCD0193				
CBR 250 R ABS	250	2011 → 2013		FCD0193				
CBX 250 RSE	250	1984 →	FSS0403	FCD0162				
CD 250	250	1988 → 1992	FSS0112	FCD0127	FCD0127/1			
CJ 250 I	250	1977 →	FSS0115	FCD0168				
CL 250 SC	250	1981 →	FSS0103	FCD0111				
CM 250 TB	250	1981 →		FCD0102				
CMX 250 C REBEL	250	1996 → 2000	FSS0112	FCD0127	FCD0127/1			
CR 250 R	250	1978 → 1980	FSS0115	FCD0117				
CR 250 R	250	1981 →	FSS0117	FCD0152				
CR 250 R	250	1982 →	FSS0117	FCD0152				
CR 250 R	250	1983 → 1989	FSS0113	FCD0120	FCD0120/1	FCS0120/2		FCS0120/3
CR 250 R	250	1990 → 1994	FSS0113	FCD0142	FCD0142/1	FCS0142/2		FCS0142/3
CR 250 R - E	250	1995 → 2010	FSS0306	FCD0142	FCD0142/1	FCS0142/2		FCS0142/3

FCDXXXX
FCDXXXX/1
FCSXXXX/2
FCSXXXX/3STANDARD
HIGH PERFORMANCE
STANDARD
HIGH PERFORMANCEFRICTION PLATES ONLY
FRICTION PLATES ONLY
FRICTION PLATES + STEEL PLATES
FRICTION PLATES + STEEL PLATES

Updated on November 2020

20013

HONDA

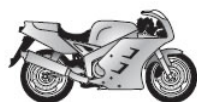

KIT RANGE



STANDARD HIGH PERFORMANCE



STANDARD HIGH PERFORMANCE

...HONDA

					STANDARD	HIGH PERFORMANCE	STANDARD	HIGH PERFORMANCE
CR 250 SUPERMOTARD	250	1998 → 2001	FSS0306	FCD0142	FCD0142/1	FCS0142/2	FCS0142/3	
CRE 250 IE	250	2007 → 2008	FSS0123	FCD0675	FCD0675/1	FCS0675/2	FCS0675/3	
CRF 250 X	250	2004 →	FSS0123	FCD0675	FCD0675/1	FCS0675/2	FCS0675/3	
CRF 250 R - E	250	2004 → 2007	FSS0123	FCD1114	FCD1114/1	FCS1114/2	FCS1114/3	
CRF 250 R - E	250	2008 → 2009	FSS0123	FCD0675	FCD0675/1	FCS0675/2	FCS0675/3	
CRF 250 R - E	250	2010 →		FCD1114	FCD1114/1	FCS1114/2	FCS1114/3	
CRF 250 R EFI	250	2010 →		FCD0675	FCD0675/1	FCS0675/2	FCS0675/3	
CRF 250 R - E	250	2011 → 2014		FCD0675	FCD0675/1	FCS0675/2	FCS0675/3	
CRF 250 LD	250	2013 → 2015		FCD1332		FCS1332/2		
CRF 250 ME SUPERMOTO	250	2014 → 2015		FCD1332		FCS1332/2		
CRF 250 R - E	250	2015 →		FCD0675	FCD0675/1	FCS0675/2	FCS0675/3	
CRM 250 R	250	1989 → 1993		FCD0129				
CRM 250 R	250	1994 → 1996	FSS0113	FCD0125	FCD0125/1			
CRM 250 ACTIVE RADIAL	250	1997 → 1998		FCD0125	FCD0125/1			
CRM 250 X SUPERMOTARD	250	2007 →	FSS0123	FCD0675	FCD0675/1	FCS0675/2	FCS0675/3	
GB 250 CUSTOM	250	1984 → 1997	FSS0403	FCD0162				
NS 250	250	1984 →	FSS0109	FCD1127	FCD1127/1			
NSR 250 R	250	1986 → 1987	FSS0112	FCD0125	FCD0125/1			
NSR 250	250	1986 →	FSS0112	FCD0125	FCD0125/1			
NSR 250 R - SP	250	1988 → 1993	FSS0112	FCD0125	FCD0125/1			
NSR 250 R SE-SP	250	1994 →	FSS0112	FCD0125	FCD0125/1			
NX 250 DOMINATOR	250	1987 → 1993		FCD1129				
TL 250	250	1978 → 1979		FCD0152				
TLR 250	250	1985 →		FCD0101		FCS0101/2		
VT 250 F	250	1982 → 1987	FSS0406	FCD0127	FCD0127/1			
VT 250 F INTEGRA	250	1987 →		FCD0183				
VT 250 SPADA	250	1988 → 1990		FCD0183				
VT 250 CR MAGNA	250	1994 →		FCD1128				
VTR 250	250	1998 → 2007		FCD1128				
VTR 250	250	2009 → 2010		FCD0183				
VTZ 250	250	1986 → 1988		FCD1128				
XL 250 S	250	1978 → 1981	FSS0103	FCD0191				
XL 250	250	1978 → 1979		FCD0152				
XL 250 R	250	1981 → 1983	FSS0103	FCD0111				
XL 250 S	250	1982 →	FSS0103	FCD0191				
XL 250 R	250	1984 → 1985		FCD1117				
XL 250 DEGREEE	250	1991 →	FSS0103	FCD1129				
XLR 250 R BAJA	250	1988 → 1990		FCD1117				
XLR 250 R BAJA	250	1991 →		FCD1129				
XR 250 S	250	1979 → 1980	FSS0103	FCD0191				
XR 250 R	250	1981 → 1983	FSS0103	FCD0111				
XR 250 R	250	1984 → 1985		FCD1117				
XR 250 R	250	1986 → 1995	FSS0101	FCD0126	FCD0126/1	FCS0126/2	FCS0126/3	
XR 250 R	250	1996 → 2004	FSS0413	FCD0126	FCD0126/1	FCS0126/2	FCS0126/3	
XR 250	250	2000 → 2003		FCD1129				
XR 250 BAJA	250	2000 → 2003		FCD1129				
XR 250 MOTARD	250	2003 → 2005		FCD1129				
CRE 290 IE	290	2007 → 2008	FSS0123	FCD0675	FCD0675/1	FCS0675/2	FCS0675/3	
CRF 300 X	300	2008 → 2012	FSS0123	FCD0675	FCD0675/1	FCS0675/2	FCS0675/3	
CB 350 K4	350	→	FSS0402	FCD0168				
CB 350 SG	350	1986 → 1988	FSS0106	FCD0102				
XR 350 R	350	1983 → 1984	FSS0101	FCD0126	FCD0126/1	FCS0126/2	FCS0126/3	
CB 400 F - F1 - F2	400	1975 → 1979	FSS0127	FCD0102				
CB 400 N - NA - NB	400	1978 → 1982	FSS0119	FCD0102				
CB-1 400 F	400	1989 → 1990	FSS0301	FCD0138				
CB 400 SUPER FOUR	400	1992 → 1997	FSS0301	FCD0138				
CB 400 FOUR	400	1997 → 1998		FCD0138				
CB 400 SUPER FOUR BOL DOR	400	1999 → 2005		FCD0146				
CB 400 SS	400	2002 →	FSS0306	FCD0125	FCD0125/1			
CBR 400 R HURRICANE	400	1986 →		FCD0138				
CBR 400 RR (TRI ARM NC23)	400	1987 → 1989	FSS0301	FCD0138				
CBR 400 RR (GULL ARM NC29)	400	1990 → 1994		FCD1116		FCS1116/2		
NS 400 R	400	1985 → 1987		FCD1127	FCD1127/1			
NTV 400 BROS	400	1988 →	FSS0113	FCD1115				
NV 400 C STEED	400	1992 → 1997	FSS0113	FCD1115				
NV 400 D SHADOW SLASHER	400	2000 → 2002	FSS0113	FCD1115				
RVF 400	400	1994 → 1996		FCD0186				
VF 400 FD	400	1983 → 1985	FSS0103	FCD0167				
VFR 400 R	400	1985 → 1986	FSS0301	FCD0123				
VFR 400 R	400	1987 → 1988	FSS0103	FCD0123				
VFR 400 R (NC 30)	400	1989 → 1992		FCD0181				
VRX 400 T (NC33)	400	1996 →		FCD0115				
XR 400 R	400	1996 →		FCD0129				
XR 400 R	400	1997 → 2005		FCD0129				
XR 400 SUPERMOTARD	400	2005 → 2008	FSS0306	FCD0125	FCD0125/1			
XR 440 R (DALLARA)	440	1999 →		FCD0129				

HONDA

20014

FERODO
RACING
Updated on November 2020

FCDXXX
FCDXXX/1
FCSXXX/2
FCSXXX/3

STANDARD
HIGH PERFORMANCE
STANDARD
HIGH PERFORMANCE

FRICITION PLATES ONLY
FRICITION PLATES ONLY
FRICITION PLATES + STEEL PLATES
FRICITION PLATES + STEEL PLATES

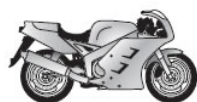

KIT RANGE



STANDARD

HIGH PERFORMANCE



STANDARD

HIGH PERFORMANCE

...HONDA

					STANDARD	HIGH PERFORMANCE	STANDARD	HIGH PERFORMANCE
CB 450 DX	450	1989	→	FSS0119	FCD0102			
CR 450 R	450	1981	→	FSS0117	FCD0152			
CRF 450 R - E	450	2002	→ 2003	FSS0306	FCD0142	FCD0142/1	FCS0142/2	FCS0142/3
CRF 450 R - E	450	2004	→ 2005		FCD0142	FCD0142/1	FCS0142/2	FCS0142/3
CRF 450 X	450	2005	→		FCD0142	FCD0142/1	FCS0142/2	FCS0142/3
CRF 450 R - E	450	2006	→ 2008	FSS0306	FCD0142	FCD0142/1	FCS0142/2	FCS0142/3
CRF 450 R - E	450	2009	→ 2010		FCD0142	FCD0142/1	FCS0142/2	FCS0142/3
CRF 450 R - E	450	2011	→ 2014		FCD1107	FCD1107/1	FCS1107/2	FCS1107/3
CRF 450 R - E	450	2015	→		FCD1107	FCD1107/1	FCS1107/2	FCS1107/3
CRF 450 R - E	450	2017	→ 2019		FCD1333	FCD1333/1	FCS1333/2	
CRF 450 RX	450	2017	→ 2019		FCD1333	FCD1333/1	FCS1333/2	
CRF 450 X	450	2019	→		FCD1333	FCD1333/1	FCS1333/2	
CR 480 R	480	1982	→	FSS0112	FCD0152			
CR 480 R	480	1983	→	FSS0113	FCD0120	FCD0120/1	FCS0120/2	FCS0120/3
CB 500 K1 - K2	500	1975	→ 1977	FSS0402	FCD0154			
CB 500 T	500	1975	→ 1977	FSS0106	FCD0166			
CB 500	500	1994	→ 2003		FCD0125	FCD0125/1		
CBF 500 ABS	500	2004	→ 2007		FCD0125	FCD0125/1		
CBF 500	500	2004	→ 2007		FCD0125	FCD0125/1		
CBR 500 F	500	1987	→ 1990	FSS0105	FCD1126		FCS1126/2	
CR 500 R	500	1984	→ 1989	FSS0113	FCD0120	FCD0120/1	FCS0120/2	FCS0120/3
CR 500 R	500	1990	→ 2001	FSS0113	FCD0142	FCD0142/1	FCS0142/2	FCS0142/3
CR 500 R	500	2002	→	FSS0113	FCD0142	FCD0142/1	FCS0142/2	FCS0142/3
CRM 500 X SUPERMOTARD	500	2007	→	FSS0113	FCD0142	FCD0142/1	FCS0142/2	FCS0142/3
CX 500	500	1979	→ 1985	FSS0117	FCD0105	FCD0105/1		
CX 500 T (TURBO)	500	1983	→	FSS0404	FCD0114			
FT 500 C	500	1982	→	FSS0106	FCD1108			
GL 500 DC	500	1982	→	FSS0117	FCD0105	FCD0105/1		
NX 500 DOMINATOR	500	1988	→ 1999	FSS0107	FCD1112	FCD1112/1	FCS1112/2	
VF 500 F	500	1984	→ 1985	FSS0103	FCD0123			
VT 500 ED - EF - C	500	1983	→ 1985		FCD0115			
XBR 500	500	1985	→ 1989		FCD0159	FCD0159/1		
XL 500 SZ	500	1980	→	FSS0106	FCD0102			
XL 500 SA - SB	500	1981	→	FSS0106	FCD0102			
XL 500 R - RC	500	1982	→	FSS0106	FCD0102			
XL 500 R PARIS DAKAR	500	1983	→	FSS0106	FCD0102			
XR 500 S	500	1979	→ 1980	FSS0106	FCD1108			
XR 500 R	500	1981	→ 1982	FSS0106	FCD1108			
XR 500 R	500	1983	→	FSS0106	FCD1108			
XR 500 R	500	1984	→ 1985	FSS0106	FCD1111			
CB 550	550	1978	→ 1980	FSS0103	FCD0105	FCD0105/1		
CBX 550 F	550	1982	→ 1985	FSS0304	FCD1126		FCS1126/2	
CB 600 F HORNET	600	1998	→ 1999	FSS0309	FCD0133	FCD0133/1	FCS0133/2	
CB 600 F HORNET S	600	2000	→ 2004	FSS0309	FCD0133	FCD0133/1	FCS0133/2	
CB 600 F HORNET	600	2005	→ 2006	FSS0309	FCD0133	FCD0133/1	FCS0133/2	
CB 600 F HORNET	600	2007	→	FSS0128	FCD0135	FCD0135/1	FCS0135/2	
CB 600 F HORNET ABS	600	2007	→	FSS0128	FCD0135	FCD0135/1	FCS0135/2	
CBF 600	600	2004	→ 2007	FSS0309	FCD0133	FCD0133/1	FCS0133/2	
CBF 600 ABS	600	2008	→ 2011	FSS0128	FCD0135	FCD0135/1	FCS0135/2	
CBF 600	600	2008	→ 2011	FSS0128	FCD0135	FCD0135/1	FCS0135/2	
CBR 600 F	600	1987	→ 1988	FSS0105	FCD1126		FCS1126/2	
CBR 600 F	600	1989	→ 1990	FSS0119	FCD1126		FCS1126/2	
CBR 600 F	600	1991	→ 1998	FSS0309	FCD0133	FCD0133/1	FCS0133/2	
CBR 600 F	600	1999	→ 2000	FSS0114	FCD1121	FCD1121/1		
CBR 600 F SPORT	600	2001	→ 2010	FSS0309	FCD0135	FCD0135/1	FCS0135/2	
CBR 600 F	600	2003	→ 2007	FSS0309	FCD0135	FCD0135/1	FCS0135/2	
CBR 600 RR	600	2003	→ 2015	FSS0128	FCD0135	FCD0135/1	FCS0135/2	
CBR 600 RR ABS	600	2009	→ 2015	FSS0128	FCD0135	FCD0135/1	FCS0135/2	
CBR 600 F	600	2011	→ 2012	FSS0309	FCD0135	FCD0135/1	FCS0135/2	
CBR 600 F ABS	600	2011	→ 2012	FSS0309	FCD0135	FCD0135/1	FCS0135/2	
NTV 600 BROSS	600	1988	→ 1991	FSS0306	FCD0140			
NTV 600 REVERSE	600	1988	→ 1991	FSS0306	FCD0140			
VT 600 C SHADOW	600	1992	→ 1993		FCD0125	FCD0125/1		
VT 600 C-CD SHADOW VLX	600	1994	→ 2000		FCD0125	FCD0125/1		
XL 600 R	600	1983	→ 1987	FSS0106	FCD1112	FCD1112/1	FCS1112/2	
XL 600 L	600	1985	→ 1987	FSS0107	FCD1112	FCD1112/1	FCS1112/2	
XL 600 V TRANSALP	600	1987	→ 1999	FSS0116	FCD1116		FCS1116/2	
XR 600 R	600	1985	→ 1992	FSS0107	FCD1112	FCD1112/1	FCS1112/2	
XR 600 L - R	600	1993	→ 2000	FSS0107	FCD1112	FCD1112/1	FCS1112/2	
CB 650 A - Z	650	1979	→ 1981		FCD0106			
CB 650 SCC NIGHTHAWK	650	1982	→		FCD0106			
CX 650 ED	650	1983	→ 1985	FSS0105	FCD0106			
CX 650 TD (TURBO) E	650	1983	→	FSS0404	FCD0114			
FMX 650	650	2005	→ 2008	FSS0107	FCD1112	FCD1112/1	FCS1112/2	
FX 650 VIGOR	650	1999	→ 2003	FSS0107	FCD1112	FCD1112/1	FCS1112/2	
GL 650	650	1984	→	FSS0105	FCD0106			

FCDXXXX
FCDXXXX/1
FCSXXXX/2
FCSXXXX/3

STANDARD
HIGH PERFORMANCE
STANDARD
HIGH PERFORMANCE

FRICITION PLATES ONLY
FRICITION PLATES ONLY
FRICITION PLATES + STEEL PLATES
FRICITION PLATES + STEEL PLATES

FERODO
RACING
Updated on November 2020

20015

HONDA



KIT RANGE



STANDARD HIGH PERFORMANCE



STANDARD HIGH PERFORMANCE

...HONDA

					STANDARD	HIGH PERFORMANCE	STANDARD	HIGH PERFORMANCE
NTV 650 BROS	650	1988 → 1992	FSS0113	FCD1122			FCS1122/2	
NTV 650 REVERSE	650	1993 → 1997		FCD1122			FCS1122/2	
NTV 650 DEAUVILLE	650	1998 → 2005		FCD1122			FCS1122/2	
NX 650 DOMINATOR	650	1988 → 2004	FSS0107	FCD1112		FCD1112/1	FCS1112/2	
SLR 650	650	1997 → 1998	FSS0107	FCD1112		FCD1112/1	FCS1112/2	
XL 650 V TRANSALP	650	2000 → 2007	FSS0113	FCD0140				
XR 650 L	650	1993 → 2012	FSS0107	FCD1112		FCD1112/1	FCS1112/2	
XR 650 R	650	2000 → 2007	FSS0309	FCD0188				
XRV 650 AFRICA TWIN	650	1988 → 1990	FSS0113	FCD0140				
NT 700 V DEAUVILLE	700	2006 → 2012		FCD1122			FCS1122/2	
NT 700 DEAUVILLE ABS	700	2007 → 2012		FCD1122			FCS1122/2	
NT 700 V VARADERO - ABS	700	2010 →		FCD1122			FCS1122/2	
XL 700 V TRANSALP	700	2008 → 2011	FSS0103	FCD0140				
XL 700 V TRANSALP ABS	700	2008 → 2011	FSS0103	FCD0140				
CB 750	750	1969 → 1970	FSS0103	FCD0170				
CB 750	750	1971 → 1975		FCD0179				
CB 750 F	750	1976 → 1977	FSS0127	FCD0180				
CB 750	750	1978 →	FSS0127	FCD0104				
CB 750 F	750	1979 → 1982	FSS0117	FCD0108		FCD0108/1		
CB 750	750	1980 →	FSS0117	FCD0108		FCD0108/1		
CB 750 N SEVEN FIFTY	750	1992 → 2002	FSS0301	FCD0146				
CBR 750 SUPER AERO	750	1987 →	FSS0305	FCD0174				
CBR 750 SUPER AERO	750	1988 →	FSS0305	FCD0174				
CBX 750 FE	750	1983 → 1985		FCD0118		FCD0118/1		
RVF 750 RR (RC 45)	750	1994 → 1998		FCD0144				
VF 750 SABRE	750	1982 →		FCD0118		FCD0118/1		
VF 750 C SHADOW	750	1983 →		FCD0118		FCD0118/1		
VF 750 CH	750	1987 →		FCD0118		FCD0118/1		
VF 750 C	750	1993 → 1999	FSS0113	FCD1125		FCD1125/1		
VFR 750 F INTERCEPTOR	750	1986 → 1989	FSS0113	FCD0133		FCD0133/1	FCS0133/2	
VFR 750 C V45 MAGNA	750	1988 →	FSS0113	FCD0133		FCD0133/1	FCS0133/2	
VFR 750 R (RC-30)	750	1988 → 1993		FCD0139				
VFR 750 F	750	1990 → 1997	FSS0113	FCD0133		FCD0133/1	FCS0133/2	
VT 750 C SHADOW	750	1983 → 1985		FCD0118		FCD0118/1		
VT 750 C SHADOW	750	1997 → 2012	FSS0113	FCD1122			FCS1122/2	
VT 750 BLACK WINDOW	750	2001 → 2004	FSS0113	FCD0140				
VT 750 SHADOW SPIRIT	750	2007 → 2009	FSS0113	FCD0140				
VT 750 SHADOW BLACK SPIRIT	750	2010 → 2012		FCD0140				
XLV 750 R	750	1983 → 1988		FCD0118		FCD0118/1		
XRV 750 R AFRICA TWIN	750	1990 → 2003	FSS0301	FCD0119		FCD0119/1		
PC 800 PACIFIC COAST	800	1989 → 1997		FCD0119		FCD0119/1		
VFR 800 FI	800	1998 → 1999	FSS0114	FCD1125		FCD1125/1		
VFR 800 FI	800	2000 → 2002	FSS0114	FCD0175				
VFR 800 V-TECH	800	2002 → 2005	FSS0114	FCD1127		FCD1127/1		
VFR 800	800	2006 → 2009	FSS0114	FCD1127		FCD1127/1		
VFR 800 ABS	800	2006 → 2011	FSS0114	FCD1127		FCD1127/1		
CB 900 F	900	1979 → 1985		FCD0108		FCD0108/1		
CB 900 HORNET	900	2002 → 2007	FSS0309	FCD0135		FCD0135/1	FCS0135/2	
CBR 900 RR-FIREBLADE (893 cc)	900	1992 → 1994	FSS0113	FCD1123			FCS1123/2	
CBR 900 RR FIREBLADE (918 cc)	900	1995 →	FSS0113	FCD1123			FCS1123/2	
CBR 900 RR FIREBLADE (918 cc)	900	1996 → 1997	FSS0309	FCD0147				
CBR 900 RR-FIREBLADE (918 cc)	900	1998 → 1999	FSS0309	FCD0135		FCD0135/1	FCS0135/2	
CBR 900 RR-FIREBLADE (929 cc)	900	2000 → 2001	FSS0309	FCD0133		FCD0133/1	FCS0133/2	
CBR 900 RR-FIREBLADE (954 cc)	900	2002 → 2003	FSS0309	FCD1123			FCS1123/2	
CB 1000 F	1000	1993 → 1997	FSS0114	FCD0143		FCD0143/1		
CB 1000 R	1000	2008 → 2012		FCD1103			FCS1103/2	
CB 1000 R ABS	1000	2008 → 2012		FCD1103			FCS1103/2	
CBF 1000 ABS	1000	2006 → 2011		FCD1104				
CBF 1000	1000	2006 → 2011		FCD1104				
CBF 1000 F	1000	2010 → 2014		FCD1104				
CBF 1000 F ABS	1000	2010 → 2014		FCD1104				
CBR 1000 F	1000	1987 → 1992	FSS0114	FCD0143		FCD0143/1		
CBR 1000 F-FP	1000	1993 → 1999	FSS0114	FCD0143		FCD0143/1		
CBR 1000 RR FIREBLADE	1000	2004 → 2005		FCD1103			FCS1103/2	
CBR 1000 RR	1000	2006 → 2007		FCD1103			FCS1103/2	
CBR 1000 RR FIREBLADE	1000	2008 → 2015		FCD1105		FCD1105/1		FCS1105/3
CBR 1000 RR FIREBLADE ABS	1000	2009 → 2015		FCD1105		FCD1105/1		FCS1105/3
CBX 1000	1000	1977 → 1980		FCD0165				
CBX 1000 B - C	1000	1981 →	FSS0404	FCD0165				
GL 1000 K GOLDWING	1000	1975 → 1977	FSS0404	FCD0160				
GL 1000 K GOLDWING	1000	1977 →	FSS0404	FCD0160				
GL 1000 K GOLDWING	1000	1978 →	FSS0404	FCD0103				
VF 1000 F	1000	1984 → 1986		FCD0122		FCD0122/1		
VF 1000 R	1000	1984 → 1985		FCD0122		FCD0122/1		
VF 1000 R	1000	1986 →		FCD0122		FCD0122/1		
VTR 1000 F FIRESTORM	1000	1997 → 2006		FCD1124				

HONDA

20016

FERODO
RACING
Updated on November 2020

FCDXXXX
FCDXXXX/1
FCSXXXX/2
FCSXXXX/3

STANDARD
HIGH PERFORMANCE
STANDARD
HIGH PERFORMANCE

FRICITION PLATES ONLY
FRICITION PLATES ONLY
FRICITION PLATES + STEEL PLATES
FRICITION PLATES + STEEL PLATES

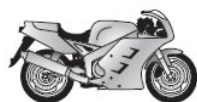

KIT RANGE



STANDARD HIGH PERFORMANCE



STANDARD HIGH PERFORMANCE

...HONDA

VTR 1000 SP1	1000	2000	→	2001	FSS0523	FCD0150		
VTR 1000 SP2	1000	2002	→	2007	FSS0523	FCD1101		
XL 1000 V VARADERO	1000	1999	→	2002		FCD0190		
XLV 1000 VARADERO	1000	2003	→	2009		FCD0144		
XLV 1000 VARADERO ABS	1000	2004	→	2009		FCD0144		
CB 1100 R	1100	1980	→	1981	FSS0103	FCD0108	FCD0108/1	
CB 1100 R	1100	1982	→	1983	FSS0207	FCD0108	FCD0108/1	
CB 1100 SF X ELEVEN (X11)	1100	2000	→	2003	FSS0523	FCD0150		
CBR 1100 XX BLACKBIRD	1100	1997	→	1998	FSS0121	FCD0149		
CBR 1100 XX SUPERBLACKBIRD	1100	1999	→	2008	FSS0523	FCD0150		
GL 1100	1100	1980	→	1981	FSS0404	FCD0114		
ST 1100 PAN EUROPEAN	1100	1989	→	2002		FCD0145		
ST 1100 PAN EUROPEAN ABS	1100	1992	→	2002		FCD0145		
VT 1100 C SHADOW	1100	1987	→	1998		FCD0196		
VT 1100 C2	1100	1995	→	2005		FCD0122	FCD0122/1	
VT 1100 C3	1100	1998	→	2000		FCD0122	FCD0122/1	
GL 1200	1200	1984	→	1985		FCD0134		
GL 1200	1200	1986	→	1987		FCD0137		
VFR 1200 F	1200	2010	→			FCD1106	FCD1106/1	
CB 1300 X4	1300	1997	→	2000	FSS0121	FCD0190		
CB 1300 F	1300	1998	→	2000		FCD0199		
CB 1300 F1	1300	2001	→			FCD0199		
CB 1300 F SUPER FOUR	1300	2003	→	2004		FCD0144		
CB 1300 SUPER BOL DOR	1300	2005	→	2008		FCD0144		
CB 1300 SUPERFOUR	1300	2005	→	2009		FCD0144		
ST 1300 PAN EUROPEAN	1300	2002	→	2012		FCD0197		
VT 1300 FURY	1300	2010	→	2012		FCD0198		
VT 1300 FURY ABS	1300	2010	→	2011		FCD0198		
VTX 1300	1300	2003	→	2008		FCD0198		
GL 1500 GOLDWING	1500	1988	→	2000		FCD0184		
GL 1500 F6C VALKYRIE	1500	1997	→	2003		FCD0184		
GL 1800 GOLDWING	1800	2001	→	2012		FCD0197		
GL 1800 GOLDWING F6B	1800	2013	→			FCD0197		
VTX 1800	1800	2002	→	2008		FCD0198		

HONDA ATV

ATC 70 all models	70	1978	→	1985	FSS0108	FCD0107		
TRX 90	90	1993	→	2011		FCD0110	FCD0110/1	
ATC 110 all models	110	1979	→	1984	FSS0108	FCD0113		
ATC 125 M	125	1984	→	1985	FSS0110	FCD0113		
ATC 125 M	125	1986	→			FCD0110	FCD0110/1	
TRX 125 J	125	1988	→			FCD0110	FCD0110/1	
ATC 185	185	1980	→	1983	FSS0111	FCD0110	FCD0110/1	
TRX 200 FOURTRAX	200	1986	→	1997		FCD1109		
ATC 250 R	250	1981	→	1984	FSS0115	FCD0117		
ATC 250 ESF/ESG/ESH/ESJ	250	1985	→	1988		FCD0130		
TRX 250 FOURTRAX	250	1985	→	1987		FCD0130		
TRX 250 R FOURTRAX	250	1986	→	1989		FCD0129		
TRX 250 X	250	1986	→	1989		FCD0129		
TRX 250	250	1986	→	1989		FCD0130		
TRX 250 X FOURTRAX	250	1987	→	1992		FCD0129		
TRX 250 RECON	250	1997	→	2012		FCD1109		
TRX 250 EX SPORTRAX	250	2001	→	2008		FCD1109		
TRX 250 X9	250	2009	→	2011		FCD1109		
TRX 300 FW FOURTRAX (4WD)	300	1988	→	2000		FCD0131		
TRX 300 EX FOURTRAX	300	1993	→	2008	FSS0101	FCD0126	FCD0126/1	FCS0126/2
TRX 300 XP	300	2009	→		FSS0101	FCD0126	FCD0126/1	FCS0126/2
TRX 350	350	1986	→	1993	FSS0105	FCD0131		FCS0126/3
TRX 350 FOURTRAX RANCHER 4x4 FEY	350	2000	→	2005	FSS0120	FCD0115		
TRX 350 FOURTRAX RANCHER 4x4 FMY	350	2000	→	2005	FSS0120	FCD0131		
FL 400 R PILOT	400	1989	→	1993		FCD0182		
TRX 400 FW	400	1995	→	2000		FCD0131		
TRX 400 EX	400	1999	→	2008	FSS0122	FCD1120		
TRX 400 X9	400	2009	→		FSS0122	FCD1120		
TRX 420 FOURTRAX FE ES 4WD	420	2007	→	2010		FCD0131		
TRX 420 FOURTRAX TE ES 2WD	420	2007	→	2009		FCD0131		
TRX 420 FOURTRAX TM	420	2007	→	2011		FCD0112		
TRX 420 FOURTRAX 4WD - Power Steering FP	420	2009	→	2011		FCD0112		
TRX 450 ES FOURTRAXFOREMAN/S	450	1998	→	2001		FCD0131		
TRX 450 R - ER	450	2004	→	2009	FSS0306	FCD0194		FCS0194/2
TRX 500 Fourtrax Foreman 4WD FE ES	500	2005	→	2011		FCD0112		
TRX 500 Fourtrax Foreman 4x4 FM	500	2005	→	2011		FCD0112		
TRX 500 FEC FOURTRAX 2WD-4WD	500	2012	→			FCD0112		
TRX 500 FMC FOURTRAX 2WD-4WD	500	2012	→			FCD0112		
TRX 700 XX	700	2008	→	2012	FSS0306	FCD1102		

FCDXXXX STANDARD FRICTION PLATES ONLY
 FCDXXXX/1 HIGH PERFORMANCE FRICTION PLATES ONLY
 FCSXXXX/2 STANDARD FRICTION PLATES + STEEL PLATES
 FCSXXXX/3 HIGH PERFORMANCE FRICTION PLATES + STEEL PLATES

FERODO
 RACING
 Updated on November 2020

20017

HONDA ATV



KIT RANGE



STANDARD
HIGH PERFORMANCE



STANDARD
HIGH PERFORMANCE

HUSQVARNA

CR 125	125	1995 → 2013	FCD0538	FCD0538/1	FCS0538/2	FCS0538/3
SM 125 SUPERMOTARD	125	1998 → 2013	FCD0538	FCD0538/1	FCS0538/2	FCS0538/3
SMS 125	125	2009 → 2013	FCD0538	FCD0538/1	FCS0538/2	FCS0538/3
TE 125	125	2014 →		FCD0501/1		FCS0501/3
WR 125	125	1995 → 2013	FCD0538	FCD0538/1	FCS0538/2	FCS0538/3
WRE 125	125	1995 → 2013	FCD0538	FCD0538/1	FCS0538/2	FCS0538/3
CR 150	150	2011 →	FCD0538	FCD0538/1	FCS0538/2	FCS0538/3
WR 150	150	2011 →	FCD0538	FCD0538/1	FCS0538/2	FCS0538/3
CR 250	250	1995 →	FCD0633	FCD0633/1		
CR 250	250	1996 → 1998	FCD0633	FCD0633/1		
CR 250	250	1999 → 2013	FCD0692		FCS0692/2	FCS0692/3
FC 250	250	2014 →		FCD0731/1		FCS0731/3
FE 250	250	2014 →		FCD0731/1		FCS0731/3
TC 250	250	2004 → 2013	FCD0538	FCD0538/1	FCS0538/2	FCS0538/3
TE 250	250	2004 → 2013	FCD0538	FCD0538/1	FCS0538/2	FCS0538/3
TXC 250	250	2010 → 2013	FCD0538	FCD0538/1	FCS0538/2	FCS0538/3
WR 250	250	1995 → 1997	FCD0633	FCD0633/1		
WR 250	250	1998 →	FCD0633	FCD0633/1		
WR 250	250	1999 → 2013	FCD0692		FCS0692/2	FCS0692/3
TC 310	310	2011 → 2013	FCD0538	FCD0538/1	FCS0538/2	FCS0538/3
TE 310 4T	310	2010 → 2013	FCD0538	FCD0538/1	FCS0538/2	FCS0538/3
TXC 310	310	2011 → 2013	FCD0538	FCD0538/1	FCS0538/2	FCS0538/3
FE 350	350	2014 →		FCD0731/1		FCS0731/3
CR 360	360	1995 → 1998	FCD0633	FCD0633/1		
WR 360	360	1995 → 1998	FCD0633	FCD0633/1		
WR 360	360	1999 → 2013	FCD0692		FCS0692/2	FCS0692/3
TE 400	400	2001 → 2013	FCD0558	FCD0558/1		
TE 410	410	1995 → 1998	FCD0633	FCD0633/1		
TE 410	410	1999 →	FCD0692		FCS0692/2	FCS0692/3
TE 410	410	2002 → 2013	FCD0558	FCD0558/1		
FE 450	450	2014 →		FCD0731/1		FCS0731/3
FE 501	501	2014 →		FCD0731/1		FCS0731/3
SM 570 R	570	2001 →	FCD0558	FCD0558/1		
TC 570	570	2002 → 2013	FCD0558	FCD0558/1		
TE 570	570	2001 →	FCD0558	FCD0558/1		
TE 570	570	2002 → 2013	FCD0558	FCD0558/1		
TC 610	610	1996 → 1997	FCD0633	FCD0633/1		
TC 610	610	1998 → 1999	FCD0692		FCS0692/2	FCS0692/3
TC 610	610	2000 → 2013	FCD0558	FCD0558/1		
TE 610	610	1996 → 1997	FCD0633	FCD0633/1		
TE 610 E	610	1998 → 1999	FCD0692		FCS0692/2	FCS0692/3
TE 610 E	610	2000 →	FCD0558	FCD0558/1		

HYOSUNG

COMET GT 125	125	2004 → 2006	FCD0684		FCS0684/2	
COMET GT 125 R EURO 2	125	2006 →	FCD0684		FCS0684/2	
COMET GT 125 AT EURO 3	125	2007 → 2008	FCD0684		FCS0684/2	
COMET GT 125 R EURO 3	125	2007 →	FCD0684		FCS0684/2	
CRUISE GA 125 F	125	2005 →	FCD0684		FCS0684/2	
GF 125 F	125	2005 →	FCD0684		FCS0684/2	
GV 125 AQUILA	125	2005 → 2009	FCD0684		FCS0684/2	
KARION RT 125	125	2004 → 2006	FCD0684		FCS0684/2	
KARION RT 125 D EURO 3	125	2007 → 2009	FCD0684		FCS0684/2	
RX 125 EURO 3	125	2007 → 2008	FCD0684		FCS0684/2	
RX 125 SM	125	2007 → 2008	FCD0684		FCS0684/2	
XRX 125 OFFROAD	125	1999 → 2006	FCD0684		FCS0684/2	
GT 250 COMET	250	2003 → 2005		FCD0742/1		
GT 250 COMET FI EURO 3	250	2007 → 2008		FCD0742/1		
GT 250 COMET R	250	2007 →		FCD0742/1		
GT 250 COMET R FI EURO 3	250	2007 → 2008		FCD0742/1		
GV 250 AQUILA	250	2004 → 2007		FCD0742/1		
GV 250 AQUILA FI & EI EURO 3	250	2008 → 2009		FCD0742/1		
TE 450 RAPIER	450	2007 → 2008		FCD0685/1		
GT 650 COMET	650	2004 → 2006		FCD0685/1		
GT 650 COMET R - S	650	2005 → 2006		FCD0685/1		
GT 650 FI	650	2007 → 2008		FCD0685/1		
GT 650 R TTC	650	2007 → 2008		FCD0685/1		
GT 650 RFI	650	2007 → 2008		FCD0685/1		
GV 650 AQUILA	650	2005 → 2007		FCD0685/1		
GV 650 AQUILA FI - FI LE	650	2007 → 2010		FCD0685/1		
I DELUXE 700	700	2013 →		FCD0685/1		
ST7 700	700	2010 →		FCD0685/1		

HUSQVARNA

20018



Updated on November 2020

FCDXXXX
FCDXXXX/1
FCSXXXX/2
FCSXXXX/3

STANDARD
HIGH PERFORMANCE
STANDARD
HIGH PERFORMANCE

FRICITION PLATES ONLY
FRICITION PLATES ONLY
FRICITION PLATES + STEEL PLATES
FRICITION PLATES + STEEL PLATES



STANDARD HIGH PERFORMANCE



STANDARD HIGH PERFORMANCE

INNOCENTI

Model	CC	Year Range	FSS Code	Kit	Standard	High Performance
LAMBRETTA 125 DL	125	→		FCD0545		FCS0545/2
LAMBRETTA 125 LI	125	→		FCD0545		FCS0545/2
LAMBRETTA J 125	125	→		FCD0545		FCS0545/2
LAMBRETTA 150 DL	150	→		FCD0545		FCS0545/2
LAMBRETTA 150 LI	150	→		FCD0545		FCS0545/2
LAMBRETTA 175 LI	175	→		FCD0545		FCS0545/2
LAMBRETTA 175 TV II	175	→		FCD0545		FCS0545/2
LAMBRETTA 175	175	→		FCD0545		FCS0545/2
LAMBRETTA 200 DL	200	→		FCD0545		FCS0545/2

KAWASAKI

Model	CC	Year Range	FSS Code	Kit	Standard	High Performance
AE 50	50	1981 → 1984	FSS0108	FCD0436		
AR 50	50	1981 → 1997	FSS0108	FCD0436		
KDX 50	50	2003 → 2006		FCD0319		
KSR 50 (KMX50)	50	1990 → 1991	FSS0125	FCD0436		
KX 60	60	1983 → 2003	FSS0108	FCD0411		FCS0411/2
KX 65	65	2000 →	FSS0410	FCD0411		FCS0411/2
AE 80	80	1981 → 1983	FSS0108	FCD0413		
AR 80	80	1981 → 1991	FSS0108	FCD0413		
KSR II 80 (KMX 80)	80	1990 → 1991	FSS0125	FCD0413		
KX 80	80	1983 →	FSS0410	FCD0473		
KX 80	80	1984 →	FSS0410	FCD0473		
KX 80	80	1985 → 1987		FCD0419		
KX 80	80	1988 →		FCD0445		
KX 80	80	1989 → 1996		FCD0423		
KX 80	80	1997 →		FCD0423		
KX 80	80	1998 → 2000		FCD0415		FCS0415/2
KX 85	85	2001 → 2015		FCD0415		FCS0415/2
KC 100	100	1980 → 1983	FSS0405	FCD0413		
KE 100	100	1979 → 1981	FSS0405	FCD0413		
KE 100	100	1982 → 1998	FSS0410	FCD0413		
KH 100	100	1978 → 1987	FSS0405	FCD0413		
KM 100	100	1978 → 1981	FSS0405	FCD0413		
KX 100	100	1988 →		FCD0445		
KX 100	100	1989 → 1996		FCD0423		
KX 100	100	1997 →		FCD0423		
KX 100	100	1998 → 2000		FCD0415		FCS0415/2
KX 100	100	2001 → 2014		FCD0415		FCS0415/2
KLX 110	110	2002 → 2015	FSS0410	FCD0473		
KAZE 115 R	115	1998 →		FCD0449		
AR 125	125	1982 → 1994	FSS0117	FCD0481		
BN 125	125	1998 → 1999	FSS0117	FCD0442		
BN 125 ELIMINATOR	125	2000 → 2007	FSS0117	FCD0442		
KDX 125	125	1990 → 1994	FSS0401	FCD0438		
KE 125	125	1980 → 1985	FSS0401	FCD0437		
KH 125	125	1977 → 1981	FSS0401	FCD0437		
KH 125	125	1982 →	FSS0410	FCD0413		
KH 125	125	1983 → 1998	FSS0410	FCD0473		
KLX 125	125	2003 → 2006	FSS0307	FCD0301		
KLX 125 L	125	2003 → 2006	FSS0307	FCD0301		
KLX 125 D-TRACKER	125	2010 → 2012		FCD0465		FCS0465/2
KLX 125	125	2010 → 2012		FCD0465		FCS0465/2
KMX 125	125	1986 → 1987	FSS0115	FCD0481		
KMX 125	125	1988 → 2003	FSS0115	FCD0447	FCD0447/1	
KX 125	125	1982 →	FSS0401	FCD0410		
KX 125	125	1983 →	FSS0308	FCD0444		
KX 125	125	1984 →	FSS0401	FCD0444		
KX 125	125	1985 → 1986	FSS0401	FCD0420		FCS0420/2
KX 125	125	1987 →	FSS0401	FCD0420		FCS0420/2
KX 125	125	1988 →		FCD0424		
KX 125	125	1989 →		FCD0424		
KX 125	125	1990 → 1992		FCD0425		FCS0425/2
KX 125	125	1993 →		FCD0448		
KX 125	125	1994 → 1996	FSS0403	FCD0485	FCD0485/1	
KX 125	125	1997 → 2002	FSS0413	FCD0406	FCD0406/1	FCS0406/2
KX 125	125	2003 → 2005	FSS0417	FCD0406	FCD0406/1	FCS0406/2
KX 125	125	2006 →	FSS0417	FCD0406	FCD0406/1	FCS0406/2
KX 125	125	2006 →	FSS0417	FCD0406	FCD0406/1	FCS0406/2
KDX 175	175	1980 → 1982	FSS0401	FCD0410		
KE 175	175	1979 → 1983	FSS0205	FCD0437		
KDX 200	200	1983 → 1984	FSS0308	FCD0444		
KDX 200	200	1985 →	FSS0401	FCD0444		
KDX 200	200	1986 →	FSS0401	FCD0444		
KDX 200	200	1987 → 1988	FSS0401	FCD0476		
KDX 200	200	1989 →	FSS0404	FCD0469		
KDX 200	200	1990 → 1994	FSS0404	FCD0469		

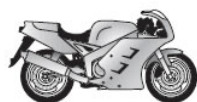

KIT RANGE



STANDARD
HIGH PERFORMANCE



STANDARD
HIGH PERFORMANCE

...KAWASAKI

Model	Year	Year Range	Code	Kit	Kit	Kit	Kit
				STANDARD	HIGH PERFORMANCE	STANDARD	HIGH PERFORMANCE
KDX 200	200	1995 → 1999		FCD0429			
KMX 200	200	1988 → 1992	FSS0103	FCD0447	FCD0447/1		
Z 200	200	1977 →		FCD0414			
Z 200	200	1978 → 1982		FCD0485	FCD0485/1		
Z 200	200	1983 →		FCD0485	FCD0485/1		
KDX 220	220	1995 → 1999		FCD0429			
BJ 250 ESTRELLA	250	1996 → 2002		FCD0441			
BJ 250 ESTRELLA CUSTOM	250	1996 → 2002		FCD0441			
BJ 250 F1/F2	250	2002 → 2003	FSS0403	FCD0441			
EL 250 ELIMINATOR	250	1987 → 1989		FCD0421			
EL 250	250	1990 → 2003		FCD0421			
ER 250 (Z 250 T SCORPION)	250	1983 → 1988	FSS0403	FCD0407			
EX 250 R NINJA	250	2008 → 2012		FCD0464			
GPX 250 R (EX E)	250	1986 →		FCD0421			
GPX 250 R NINJA	250	1987 →		FCD0421			
GPX 250 R	250	1988 → 1995		FCD0421			
GPX 250 R II (EX G)	250	1988 →		FCD0421			
KDX 250	250	1981 →	FSS0301	FCD0412			
KDX 250	250	1982 → 1984	FSS0301	FCD0407			
KDX 250	250	1991 → 1993		FCD0486	FCD0486/1		
KH 250	250	1979 → 1980	FSS0401	FCD0410			
KL 250	250	1978 → 1984	FSS0403	FCD0485	FCD0485/1		
KL 250 SUPER SHERPA	250	1997 →	FSS0415	FCD0477			
KLE 250 ANHELO	250	1995 → 2001	FSS0403	FCD0421			
KLF 250 BAYOU	250	2003 → 2011		FCD1117			
KLF 250 BAYOU	250	2012 → 2013		FCD1117			
KLR 250 all models	250	1984 → 2005		FCD0471		FCS0471/2	
KLX 250 D1 - D4 - ES	250	1993 → 1997	FSS0401	FCD0477			
KLX 250 TRACKER	250	1998 → 2003	FSS0401	FCD0477			
KLX 250 S	250	2006 → 2007		FCD0476			
KLX 250 SF	250	2009 → 2012		FCD0476			
KLX 250 S	250	2009 →		FCD0476			
KR 250	250	1984 → 1986	FSS0404	FCD0460			
KR-1 250 (KR 250 B2)	250	1989 →	FSS0404	FCD0433			
KR-1 250 (KR 250 C2/C3)	250	1990 → 1992	FSS0404	FCD0433			
KX 250	250	1974 →	FSS0403	FCD0403			
KX 250	250	1975 → 1979	FSS0403	FCD0403			
KX 250	250	1980 → 1981	FSS0403	FCD0412			
KX 250	250	1982 →	FSS0404	FCD0451			
KX 250	250	1983 → 1984	FSS0404	FCD0451			
KX 250	250	1985 →	FSS0404	FCD0470			
KX 250	250	1986 →	FSS0404	FCD0470			
KX 250	250	1987 → 1988	FSS0403	FCD0422	FCD0422/1	FCS0422/2	
KX 250	250	1989 →	FSS0403	FCD0422	FCD0422/1	FCS0422/2	
KX 250	250	1990 →	FSS0301	FCD0422	FCD0422/1	FCS0422/2	
KX 250	250	1991 →		FCD0486	FCD0486/1		
KX 250	250	1992 → 2008		FCD0409	FCD0409/1	FCS0409/2	FCS0409/3
KX F 250	250	2004 → 2014	FSS0417	FCD0378	FCD0378/1	FCS0378/2	FCS0378/3
KX F 250	250	2015 →	FSS0417	FCD0378	FCD0378/1	FCS0378/2	FCS0378/3
Z 250	250	1978 → 1980	FSS0301	FCD0407			
Z 250 B1 - B2	250	1980 → 1983	FSS0301	FCD0407			
Z 250 C1 - C2	250	1981 →	FSS0403	FCD0485	FCD0485/1		
Z 250	250	1981 →	FSS0301	FCD0407			
ZR 250 BALIUS	250	1991 → 1995	FSS0403	FCD0441			
ZR 250 BALIUS II	250	2002 →	FSS0403	FCD0441			
ZXR 250 R	250	1989 → 1990	FSS0403	FCD0432			
ZXR 250	250	1989 → 1995	FSS0403	FCD0441			
ZXR 250 R	250	1991 →	FSS0403	FCD0441			
ZZR 250	250	1990 → 2003		FCD0421			
KLX 300	300	1997 →	FSS0401	FCD0477			
KLX 300	300	1998 → 2006		FCD0477			
GPZ 305 all models	305	1983 → 1996	FSS0404	FCD0407			
FX 400 R (ZX 400)	400	1985 → 1988	FSS0406	FCD0475			
KH 400 A3-5	400	1976 → 1978	FSS0401	FCD0444			
KLX 400 R	400	2003 → 2004	FSS0318	FCD0363	FCD0363/1	FCS0363/2	
NINJA 400	400	2018 → 2019		FCD1324	FCD1324/1		
NINJA 400 KRT EDITION	400	2018 → 2019		FCD1324	FCD1324/1		
Z 400 B1 - B2	400	1978 → 1980	FSS0404	FCD0404			
Z 400 G1	400	1979 →	FSS0404	FCD0404			
Z 400 J1 LTD	400	1980 →	FSS0404	FCD0405	FCD0405/1	FCS0405/2	FCS0405/3
Z 400 J2 - J3	400	1981 → 1983	FSS0404	FCD0405	FCD0405/1	FCS0405/2	FCS0405/3
ZL 400 ELIMINATOR	400	1986 → 1987	FSS0403	FCD0479	FCD0479/1	FCS0479/2	FCS0479/3
ZL 400 ELIMINATOR	400	1988 →	FSS0403	FCD0479	FCD0479/1	FCS0479/2	FCS0479/3
ZL 400	400	1994 → 1995		FCD0475			
ZR 400	400	1983 → 1984	FSS0404	FCD0405	FCD0405/1	FCS0405/2	FCS0405/3
ZR 400 XANTUS	400	1992 → 1995	FSS0403	FCD0414			

KAWASAKI

20020

FERODO
RACING
Updated on November 2020

FCDXXXX
FCDXXXX/1
FCSXXXX/2
FCSXXXX/3

STANDARD
HIGH PERFORMANCE
STANDARD
HIGH PERFORMANCE

FRICTION PLATES ONLY
FRICTION PLATES ONLY
FRICTION PLATES + STEEL PLATES
FRICTION PLATES + STEEL PLATES

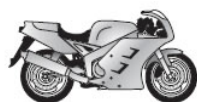

KIT RANGE



STANDARD

HIGH PERFORMANCE



STANDARD

HIGH PERFORMANCE

...KAWASAKI

ZR 400 ZEPHYR	400	1997 → 2001	FSS0404	FCD0478				
ZRX 400	400	1994 → 2001		FCD0475				
ZX 400 C2	400	1985 →	FSS0404	FCD0405	FCD0405/1	FCS0405/2	FCS0405/3	
ZXR 400	400	1989 → 1990	FSS0403	FCD0414				
ZXR 400 R	400	1991 → 1994	FSS0301	FCD0472				
ZXR 400 (ZX 400L) RR	400	1992 → 2002	FSS0301	FCD0472				
ZZR 400	400	1990 → 1992	FSS0403	FCD0475				
ZZR 400	400	1993 → 1999	FSS0118	FCD0475				
KX 420 A1 - A2	420	1980 → 1981	FSS0301	FCD0412				
Z 440	440	1979 → 1983		FCD0404				
Z 440 LTD	440	1982 →		FCD0404				
Z 440 LTD	440	1983 → 1984		FCD0404				
EN 450 LTD (454)	450	1986 → 1989	FSS0404	FCD0405	FCD0405/1	FCS0405/2	FCS0405/3	
KLX 450 R	450	2008 → 2015		FCD0466	FCD0466/1	FCS0466/2	FCS0466/3	
KX F 450	450	2019 →		FCD1325	FCD1325/1	FCS1325/2		
KXF 450	450	2006 → 2014		FCD0466	FCD0466/1	FCS0466/2	FCS0466/3	
KXF 450	450	2015 →	FSS0114	FCD0466	FCD0466/1	FCS0466/2	FCS0466/3	
EN 500 all models	500	1990 → 2004	FSS0404	FCD0405	FCD0405/1	FCS0405/2	FCS0405/3	
ER-5 500 TWISTER	500	1997 → 2007	FSS0404	FCD0405	FCD0405/1	FCS0405/2	FCS0405/3	
EX 500 all models	500	1987 → 1993	FSS0404	FCD0405	FCD0405/1	FCS0405/2	FCS0405/3	
EX 500 NINJA	500	1994 → 1997	FSS0404	FCD0405	FCD0405/1	FCS0405/2	FCS0405/3	
EX 500	500	1994 → 1996	FSS0404	FCD0405	FCD0405/1	FCS0405/2	FCS0405/3	
GPZ 500 S	500	1988 → 2004	FSS0404	FCD0405	FCD0405/1	FCS0405/2	FCS0405/3	
H1 500 Mach 111	500	1969 → 1972	FSS0403	FCD0485	FCD0485/1			
H1 500 S Mach 111	500	1971 →	FSS0403	FCD0485	FCD0485/1			
H1 500	500	1973 → 1975	FSS0403	FCD0485	FCD0485/1			
KH 500	500	1976 →	FSS0403	FCD0485	FCD0485/1			
KLE 500	500	1991 → 2007		FCD0405	FCD0405/1	FCS0405/2	FCS0405/3	
KX 500	500	1983 → 1984	FSS0404	FCD0407				
KX 500	500	1985 → 1986		FCD0417				
KX 500	500	1987 → 2004	FSS0404	FCD0422	FCD0422/1	FCS0422/2		
Z 500	500	1979 → 1980	FSS0404	FCD0405	FCD0405/1	FCS0405/2	FCS0405/3	
GPZ 550	550	1981 → 1987	FSS0404	FCD0405	FCD0405/1	FCS0405/2	FCS0405/3	
GT 550	550	1983 → 2001	FSS0404	FCD0405	FCD0405/1	FCS0405/2	FCS0405/3	
Z 550 A3 - C1 - C2 LTD	550	1980 →	FSS0404	FCD0405	FCD0405/1	FCS0405/2	FCS0405/3	
ZR 550 A1	550	1983 → 1984	FSS0404	FCD0405	FCD0405/1	FCS0405/2	FCS0405/3	
ZR 550 ZEPHYR	550	1990 → 1999	FSS0404	FCD0478				
GPX 600 R	600	1988 → 1996	FSS0404	FCD0478				
GPZ 600 R	600	1985 → 1989	FSS0404	FCD0405	FCD0405/1	FCS0405/2	FCS0405/3	
KLR 600	600	1984 → 1986	FSS0404	FCD0405	FCD0405/1	FCS0405/2	FCS0405/3	
KLR 600 ELECTRIC STARTER	600	1985 → 1994	FSS0404	FCD0405	FCD0405/1	FCS0405/2	FCS0405/3	
ZL 600 ELIMINATOR	600	1995 → 1997	FSS0406	FCD0478				
ZX-6R 600 NINJA	600	1994 → 2001	FSS0411	FCD0428	FCD0428/1	FCS0428/2		
ZX-6 RR 600 NINJA	600	2003 →	FSS0418	FCD0428	FCD0428/1	FCS0428/2		
ZX-6 RR 600 NINJA	600	2004 →	FSS0418	FCD0455				
ZX-6 RR 600 NINJA	600	2005 → 2006		FCD0458				
ZX-6R 600 NINJA	600	2007 → 2012		FCD0457	FCD0457/1		FCS0457/3	
ZZR 600	600	1990 → 1992	FSS0404	FCD0479	FCD0479/1	FCS0479/2	FCS0479/3	
ZZR 600	600	1993 → 2005	FSS0118	FCD0479	FCD0479/1	FCS0479/2	FCS0479/3	
ZZR 600 (ZX E6F)	600	2006 → 2007	FSS0118	FCD0479	FCD0479/1	FCS0479/2	FCS0479/3	
ZX-6R 636 NINJA	636	2002 →	FSS0411	FCD0428	FCD0428/1	FCS0428/2		
ZX-6R 636 NINJA	636	2003 → 2004	FSS0411	FCD0428	FCD0428/1	FCS0428/2		
ZX-6R 636 NINJA	636	2005 → 2006		FCD0456		FCS0456/2		
ZX-6R 636 NINJA	636	2013 → 2015		FCD0487		FCS0487/2	FCS0487/3	
ER - 6F 650	650	2006 → 2012	FSS0404	FCD0479	FCD0479/1	FCS0479/2	FCS0479/3	
ER - 6F 650 ABS	650	2006 → 2012	FSS0404	FCD0479	FCD0479/1	FCS0479/2	FCS0479/3	
ER - 6N 650	650	2006 → 2012	FSS0404	FCD0479	FCD0479/1	FCS0479/2	FCS0479/3	
ER - 6N 650 ABS	650	2006 → 2012	FSS0404	FCD0479	FCD0479/1	FCS0479/2	FCS0479/3	
ER - 6F 650	650	2013 → 2015	FSS0404	FCD0479	FCD0479/1	FCS0479/2	FCS0479/3	
ER - 6F 650 ABS	650	2013 → 2015	FSS0404	FCD0479	FCD0479/1	FCS0479/2	FCS0479/3	
ER - 6N 650	650	2013 → 2015	FSS0404	FCD0479	FCD0479/1	FCS0479/2	FCS0479/3	
ER - 6N 650 ABS	650	2013 → 2015	FSS0404	FCD0479	FCD0479/1	FCS0479/2	FCS0479/3	
KL 650 TENGAI	650	1989 → 1992		FCD0405	FCD0405/1	FCS0405/2	FCS0405/3	
KLE 650 VERSYS	650	2007 → 2012	FSS0404	FCD0479	FCD0479/1	FCS0479/2	FCS0479/3	
KLE 650 VERSYS ABS	650	2007 → 2012	FSS0404	FCD0479	FCD0479/1	FCS0479/2	FCS0479/3	
KLR 650	650	1987 → 1994		FCD0405	FCD0405/1	FCS0405/2	FCS0405/3	
KLR 650	650	1995 → 2004		FCD0482		FCS0482/2		
KLR 650	650	2008 → 2009		FCD0482		FCS0482/2		
KLX 650 R	650	1993 → 1997		FCD0405	FCD0405/1	FCS0405/2	FCS0405/3	
W 650 (EJ 650)	650	1999 → 2006	FSS0404	FCD0480		FCS0480/2	FCS0480/3	
Z 650 C CUSTOM	650	1977 → 1980	FSS0404	FCD0402				
Z 650	650	1977 → 1979	FSS0403	FCD0402				
Z 650 F1	650	1980 →	FSS0404	FCD0402				
Z 650	650	1981 → 1983	FSS0404	FCD0402				
VN 700 VULCAN	700	1985 → 1994	FSS0403	FCD0480		FCS0480/2	FCS0480/3	
Z 700 A1 LTD	700	1984 →	FSS0403	FCD0402				

FCDXXXX
FCDXXXX/1
FCSXXXX/2
FCSXXXX/3

STANDARD
HIGH PERFORMANCE
STANDARD
HIGH PERFORMANCE

FRICITION PLATES ONLY
FRICITION PLATES ONLY
FRICITION PLATES + STEEL PLATES
FRICITION PLATES + STEEL PLATES

FERODO
RACING
Updated on November 2020

20021

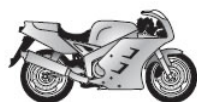

KIT RANGE



STANDARD
HIGH PERFORMANCE



STANDARD
HIGH PERFORMANCE

...KAWASAKI

					STANDARD	HIGH PERFORMANCE	STANDARD	HIGH PERFORMANCE
ZN 700 A1/A2 LTD	700	1984 → 1985	FSS0403	FCD0402				
GPX 750	750	1987 → 1989	FSS0403	FCD0480			FCS0480/2	FCS0480/3
GPZ 750 R	750	1982 →	FSS0404	FCD0402				
GPZ 750	750	1983 → 1987	FSS0404	FCD0402				
GT 750	750	1982 → 1990	FSS0403	FCD0402				
GT 750	750	1992 → 1996	FSS0406	FCD0427				
VN 750 VULCAN	750	1986 → 1994	FSS0403	FCD0480			FCS0480/2	FCS0480/3
VN 750 TWIN	750	1988 →	FSS0403	FCD0480			FCS0480/2	FCS0480/3
Z 750	750	1976 →	FSS0403	FCD0480			FCS0480/2	FCS0480/3
Z 750	750	1977 → 1978	FSS0404	FCD0480			FCS0480/2	FCS0480/3
Z 750	750	1980 → 1984	FSS0403	FCD0402				
Z 750 SPECTRE	750	1982 → 1983	FSS0403	FCD0402				
Z 750 Y1 LTD	750	1982 →	FSS0403	FCD0480			FCS0480/2	FCS0480/3
Z 750 J (ZR)	750	2004 → 2006	FSS0411	FCD0428	FCD0428/1		FCS0428/2	
Z 750 S (ZR)	750	2005 → 2007	FSS0411	FCD0428	FCD0428/1		FCS0428/2	
Z 750 ABS	750	2007 → 2009	FSS0411	FCD0428	FCD0428/1		FCS0428/2	
Z 750	750	2007 → 2011	FSS0411	FCD0428	FCD0428/1		FCS0428/2	
Z 750 R	750	2011 → 2012	FSS0411	FCD0428	FCD0428/1		FCS0428/2	
Z 750 R ABS	750	2011 → 2012	FSS0411	FCD0428	FCD0428/1		FCS0428/2	
ZR 750 ZEPHYR	750	1991 → 1995	FSS0404	FCD0427				
ZR 750 ZEPHYR	750	1996 → 1998	FSS0409	FCD0427				
ZR-7 750	750	1999 → 2004	FSS0409	FCD0427				
ZR-7S 750	750	2001 → 2004	FSS0409	FCD0427				
ZX 750 TURBO	750	1984 → 1987	FSS0404	FCD0446				
ZX-7R 750 NINJA	750	1996 → 2003	FSS0416	FCD0483	FCD0483/1			
ZX-7RR 750 NINJA	750	1996 → 1999	FSS0409	FCD0484				
ZX-7RR 750 NINJA	750	2000 → 2002	FSS0416	FCD0483	FCD0483/1			
ZXR 750	750	1989 → 1990	FSS0406	FCD0475				
ZXR 750 R	750	1991 → 1995	FSS0416	FCD0483	FCD0483/1			
VN 800	800	1995 → 1999	FSS0404	FCD0480			FCS0480/2	FCS0480/3
VN 800 CLASSIC	800	1996 → 2006	FSS0404	FCD0480			FCS0480/2	FCS0480/3
VN 800 DRIFTER	800	1999 → 2004	FSS0403	FCD0480			FCS0480/2	FCS0480/3
W 800 ABF (EJ 800)	800	2011 → 2012	FSS0404	FCD0480			FCS0480/2	FCS0480/3
GPZ 900 R	900	1984 → 1996	FSS0404	FCD0480			FCS0480/2	FCS0480/3
GPZ 900 R (ZX)	900	1998 →	FSS0404	FCD0480			FCS0480/2	FCS0480/3
GPZ 900 R (ZX)	900	1999 → 2002	FSS0404	FCD0480			FCS0480/2	FCS0480/3
VN 900 CLASSIC	900	2006 → 2012	FSS0404	FCD0480			FCS0480/2	FCS0480/3
VN 900 CUSTOM	900	2007 → 2012	FSS0404	FCD0480			FCS0480/2	FCS0480/3
Z 900 Z1A - Z1B	900	1974 → 1976	FSS0404	FCD0116				
Z 900 A 4	900	1977 →	FSS0404	FCD0116				
ZL 900 ELIMINATOR	900	1985 → 1986	FSS0406	FCD0408				
ZX-9 900 R NINJA	900	1994 → 1997	FSS0409	FCD0484				
ZX-9 900 R NINJA	900	1998 → 2004	FSS0414	FCD0467	FCD0467/1		FCS0467/2	
GPZ 1000 R	1000	1986 → 1987	FSS0406	FCD0408				
GTR 1000	1000	1986 → 2006	FSS0406	FCD0408				
KLV 1000	1000	2004 → 2005	FSS0118	FCD0385	FCD0385/1		FCS0385/2	
Z 1000 A1/A2/A3/A4	1000	1977 → 1980	FSS0404	FCD0116				
Z 1000 D1-D3 Z1R	1000	1978 → 1980	FSS0403	FCD0116				
Z 1000 SHAFT - ST	1000	1979 → 1980	FSS0406	FCD0408				
Z 1000 H1	1000	1980 →	FSS0404	FCD0116				
Z 1000 J1/J2/J3	1000	1981 → 1983	FSS0404	FCD0408				
Z 1000 LTD	1000	1981 → 1983	FSS0404	FCD0408				
Z 1000 (ZR)	1000	2003 → 2006	FSS0414	FCD0467	FCD0467/1		FCS0467/2	
Z 1000 ABS	1000	2007 → 2009	FSS0411	FCD0430	FCD0430/1			
Z 1000	1000	2007 → 2009	FSS0411	FCD0430	FCD0430/1			
Z 1000 ABS	1000	2010 → 2013		FCD0430	FCD0430/1			
Z 1000	1000	2010 → 2013		FCD0430	FCD0430/1			
Z 1000 SX ABS	1000	2011 → 2015		FCD0430	FCD0430/1			
Z 1000 SX	1000	2011 → 2015		FCD0430	FCD0430/1			
Z 1000	1000	2014 →		FCD0430	FCD0430/1			
Z 1000 ABS	1000	2014 →		FCD0430	FCD0430/1			
ZL 1000 all models	1000	1987 →	FSS0406	FCD0408				
ZX-10 1000	1000	1988 → 1990	FSS0406	FCD0408				
ZX-10R 1000 NINJA	1000	2004 → 2015		FCD0468	FCD0468/1		FCS0468/2	
ZX-10R 1000 NINJA ABS	1000	2011 → 2015		FCD0468	FCD0468/1		FCS0468/2	
GPZ 1100 (ZX 1100)	1100	1981 → 1982	FSS0404	FCD0408				
GPZ 1100 (ZX 1100)	1100	1983 → 1985	FSS0406	FCD0408				
Z 1100	1100	1981 → 1983	FSS0406	FCD0408				
Z 1100 SPECTRE - LTD	1100	1982 → 1983	FSS0406	FCD0408				
Z 1100 R1	1100	1984 →	FSS0406	FCD0408				
ZR 1100 ZEPHYR (ZR 1100 A)	1100	1992 → 1995	FSS0406	FCD0408				
ZR 1100 ZEPHYR	1100	1996 → 1997	FSS0406	FCD0408				
ZR 1100 ZEPHYR RS	1100	2002 →	FSS0406	FCD0474				
ZRX 1100	1100	1996 → 2000	FSS0406	FCD0408				
ZRX 1100 C1	1100	1997 → 2000	FSS0406	FCD0474				
ZZR 1100 GT (ZX 1100)	1100	1990 → 2001	FSS0114	FCD0426				

KAWASAKI

20022

FERODO
RACING
Updated on November 2020

FCDXXXX
FCDXXXX/1
FCSXXXX/2
FCSXXXX/3

STANDARD
HIGH PERFORMANCE
STANDARD
HIGH PERFORMANCE

FRICITION PLATES ONLY
FRICITION PLATES ONLY
FRICITION PLATES + STEEL PLATES
FRICITION PLATES + STEEL PLATES



KIT RANGE



STANDARD
HIGH PERFORMANCE



STANDARD
HIGH PERFORMANCE

...KAWASAKI

Model	Year	Year Range	FSS Code	FCD Code	Kit Type	Kit Type
ZRX 1200 R - S	1200	2001 → 2008	FSS0409	FCD0474	Standard	High Performance
ZX-12R 1200 NINJA	1200	2000 → 2001	FSS0522	FCD0431	Standard	High Performance
ZX-12R 1200 NINJA	1200	2001 → 2006	FSS0522	FCD0450	Standard	High Performance
ZZR 1200	1200	2002 → 2004	FSS0114	FCD0426	Standard	High Performance
Z 1300	1300	1979 → 1981	FSS0404	FCD0434	Standard	High Performance
Z 1300	1300	1982 → 1983	FSS0404	FCD0435	Standard	High Performance
ZG 1300 DF1	1300	1984 → 1986	FSS0403	FCD0416	Standard	High Performance
GTR 1400	1400	2008 → 2012	FSS0406	FCD0463	Standard	High Performance
ZZR 1400 ABS	1400	2006 → 2012		FCD0461	Standard	High Performance
ZZR 1400	1400	2006 → 2012		FCD0461	Standard	High Performance
VN 1500 B2/C1/C2/D1	1500	1988 → 1996		FCD0416	Standard	High Performance
VN 1500 B2-B6	1500	1988 → 1992		FCD0416	Standard	High Performance
VN 1500 C1/C2	1500	1994 → 1995		FCD0416	Standard	High Performance
VN 1500 D1/D2 CLASSIC	1500	1996 → 1998		FCD0416	Standard	High Performance
VN 1500 G1/G2	1500	1998 → 1999		FCD0416	Standard	High Performance
VN 1500 CLASSIC TOURER	1500	1998 → 1999		FCD0416	Standard	High Performance
VN 1500 DRIFTER	1500	1999 → 2004		FCD0416	Standard	High Performance
VN 1500 CLASSIC TOURER F1	1500	2000 → 2004		FCD0416	Standard	High Performance
VN 1500 NOMAD	1500	2000 → 2003		FCD0416	Standard	High Performance
VN 1500 MEAN STREAK	1500	2002 → 2004		FCD0416	Standard	High Performance
VN 1600 CLASSIC	1600	2003 → 2008		FCD0416	Standard	High Performance
VN 1600 MEAN STREAK	1600	2004 →		FCD0416	Standard	High Performance
VN 1600 CLASSIC TOURER	1600	2005 → 2008		FCD0416	Standard	High Performance
VN 1600 MEAN STREAK	1600	2005 → 2008		FCD0416	Standard	High Performance
VN 1700 CLASSIC	1700	2009 →		FCD0459	Standard	High Performance
VN 1700 CLASSIC TOURER	1700	2009 → 2012		FCD0459	Standard	High Performance
VN 1700 VOYAGER	1700	2009 → 2011		FCD0459	Standard	High Performance
VN 2000	2000	2004 → 2007	FSS0411	FCD0459	Standard	High Performance
VN 2000 CLASSIC	2000	2008 → 2009	FSS0411	FCD0459	Standard	High Performance

KAWASAKI ATV

KLF 110 MOJAVE	110	1987 → 1988		FCD0418	Standard	High Performance
KLF 185	185	1987 →	FSS0402	FCD0101	Standard	FCS0101/2
KLF 220	220	1988 → 2002		FCD1117	Standard	High Performance
KLT 250 all models	250	1983 → 1985		FCD0485	FCD0485/1	High Performance
KSF 250	250	1994 → 2004		FCD0406	FCD0406/1	FCS0406/2
KEF 300 LAKOTA SPORT	300	2001 → 2002		FCD0403	Standard	FCS0406/3
KLF 300 BAYOU	300	1986 → 1987		FCD0403	Standard	High Performance
KLF 300 BAYOU (B1/B17)	300	1988 → 2004		FCD0403	Standard	High Performance
KLF 300 BAYOU (C1/C12)	300	1989 → 2005		FCD0403	Standard	High Performance
KLF 400 BAYOU 4x4	400	1993 → 1998		FCD0412	Standard	High Performance
KSF 400 (KFX 400)	400	2003 → 2004	FSS0318	FCD0363	FCD0363/1	FCS0363/2
KSF 400 (KFX 400)	400	2005 → 2006	FSS0318	FCD0387	Standard	FCS0387/2
KFX 450 R	450	2008 → 2012		FCD0462	Standard	FCS0462/2

KTM

GXE/GXR 50 ENDURO-BORA 25	50	1986 →		FCD0661	Standard	FCS0661/2
MX 50	50	1987 →		FCD0661	Standard	FCS0661/2
RSV 50	50	1986 →		FCD0661	Standard	FCS0661/2
SX 50 ADVENTURE	50	1998 →		FCD0661	Standard	FCS0661/2
SX 50 JUNIOR LC	50	2002 → 2004		FCD0664	Standard	High Performance
SX 50 PRO JUNIOR LC	50	2002 →		FCD0664	Standard	High Performance
SX 50 PRO SENJOR LC	50	2002 → 2003		FCD0664	Standard	High Performance
SX 60	60	1998 → 2000		FCD0661	Standard	FCS0661/2
SX 65	65	1998 → 2008		FCD0661	Standard	FCS0661/2
SX 65	65	2009 →		FCD0728	Standard	FCS0728/2
SX 65	65	2010 → 2014		FCD0728	Standard	FCS0728/2
SXS 65	65	2012 → 2013		FCD0728	Standard	FCS0728/2
XC 65	65	2008 → 2009		FCD0728	Standard	FCS0728/2
L-PL-RL-RS-RSL-BORA 80	80	→		FCD0664	Standard	High Performance
MX 80 GR - SUPER MINI	80	1986 → 1988		FCD0664	Standard	High Performance
MX 80	80	1989 → 1990		FCD0664	Standard	High Performance
SX 85	85	2003 → 2011		FCD0705	Standard	FCS0705/2
SX 85	85	2012 →		FCD0705	Standard	FCS0705/2
XC 85	85	2007 → 2009		FCD0705	Standard	FCS0705/2
SX 105	105	2003 → 2010		FCD0705	Standard	FCS0705/2
SX 105	105	2011 →		FCD0705	Standard	FCS0705/2
XC 105	105	2008 → 2010		FCD0705	Standard	FCS0705/2
DUKE 125	125	2011 →		FCD0465	Standard	FCS0465/2
EXC 125	125	1987 → 1993		FCD0519	Standard	FCS0519/2
EXC 125 (pinze Brembo)	125	1989 →		FCD0519	Standard	FCS0519/2
EXC 125 (pinze Grimeca)	125	1989 →		FCD0519	Standard	FCS0519/2
EXC/EGS 125	125	1994 → 1997		FCD0519	Standard	FCS0519/2
EXC 125	125	1998 → 2015			FCD0501/1	FCS0501/3

FCDXXXX STANDARD
 FCDXXXX/1 HIGH PERFORMANCE
 FCSXXXX/2 STANDARD
 FCSXXXX/3 HIGH PERFORMANCE

FRICITION PLATES ONLY
 FRICITION PLATES ONLY
 FRICITION PLATES + STEEL PLATES
 FRICITION PLATES + STEEL PLATES



2023

KTM

Updated on November 2020



KIT RANGE



STANDARD
HIGH PERFORMANCE



STANDARD
HIGH PERFORMANCE

...KTM

EXC 125 SIX DAYS	125	2004	→	2014			FCD0501/1	FCS0501/3
EXE 125	125	2000	→	2011			FCD0501/1	FCS0501/3
GS 125	125	1974	→	1982	FCD0584		FCS0584/2	
GS 125 LC	125	1983	→		FCD0584		FCS0584/2	
GS 125	125	1984	→	1987	FCD0519		FCS0519/2	
LC2 125	125	1998	→		FCD0519		FCS0519/2	
MX 125	125	1974	→	1982	FCD0584		FCS0584/2	
MX 125	125	1983	→		FCD0584		FCS0584/2	
MX 125	125	1984	→	1987	FCD0519		FCS0519/2	
MX 125	125	1988	→		FCD0519		FCS0519/2	
MX 125 (pinze Brembo)	125	1989	→	1993	FCD0519		FCS0519/2	
MX 125 (pinze Grimeca)	125	1989	→	1993	FCD0519		FCS0519/2	
MX/MXC 125	125	1986	→		FCD0519		FCS0519/2	
SUPERMOTO 125	125	2000	→	2001			FCD0501/1	FCS0501/3
SX 125	125	1998	→	2015			FCD0501/1	FCS0501/3
SXS 125	125	2001	→	2010			FCD0501/1	FCS0501/3
SX 144	144	2007	→	2010			FCD0501/1	FCS0501/3
SX 150	150	2008	→	2015			FCD0501/1	FCS0501/3
XC 150	150	2011	→	2015			FCD0501/1	FCS0501/3
DUKE 200	200	2012	→		FCD0696		FCS0696/2	
EGS 200	200	1998	→	1999			FCD0501/1	FCS0501/3
EXC 200	200	1997	→	2015			FCD0501/1	FCS0501/3
MXC 200	200	1998	→	2003			FCD0501/1	FCS0501/3
SX 200	200	2003	→	2007			FCD0501/1	FCS0501/3
XC-W 200	200	2011	→	2015			FCD0501/1	FCS0501/3
BAJA 250	250	1986	→		FCD0584		FCS0584/2	
EGS 250	250	1994	→	1999			FCD0502/1	FCS0502/3
ENDURO 250	250	1989	→		FCD0584		FCS0584/2	
EXC 250	250	1990	→	2013			FCD0502/1	FCS0502/3
EXC RACING 250 (4T)	250	2000	→	2001	FCD0504		FCD0504/1	
EXC RACING 250 (4T)	250	2002	→	2003			FCD0503/1	FCS0503/3
EXC 250 SIX DAYS (2T)	250	2004	→	2013			FCD0502/1	FCS0502/3
EXC RACING 250 (4T)	250	2004	→	2006			FCD0673/1	FCS0673/3
EXC-F 250	250	2007	→	2013	FCD0151		FCD0151/1	FCS0151/2
EXC-F 250 SIX DAYS	250	2007	→	2013	FCD0151		FCD0151/1	FCS0151/2
EXC-F 250	250	2014	→				FCD0731/1	FCS0731/3
GS 250	250	1983	→		FCD0584		FCS0584/2	
GS 250	250	1984	→		FCD0606			
GS 250	250	1985	→		FCD0584		FCS0584/2	
GS 250	250	1986	→		FCD0584		FCS0584/2	
GS 250	250	1987	→		FCD0584		FCS0584/2	
MC 250	250	1974	→	1983	FCD0584		FCS0584/2	
MC 250	250	1985	→	1990	FCD0528			
MX 250	250	1974	→	1983	FCD0584		FCS0584/2	
MX 250	250	1984	→		FCD0606			
MX 250	250	1985	→	1991	FCD0584		FCS0584/2	
MX 250	250	1992	→	2013			FCD0502/1	FCS0502/3
SX 250	250	1994	→	2012			FCD0502/1	FCS0502/3
SX 250	250	2013	→	2015			FCD0731/1	FCS0731/3
SX-F 250	250	2005	→	2012	FCD0151		FCD0151/1	FCS0151/2
SX-F 250	250	2013	→	2015			FCD0731/1	FCS0731/3
SX-F 250	250	2016	→		FCD0782		FCD0782/1	
SXS 250	250	2001	→	2003			FCD0502/1	FCS0502/3
XC 250 (2T)	250	1994	→	2012			FCD0502/1	FCS0502/3
XC 250 (2T)	250	2013	→	2015			FCD0731/1	FCS0731/3
XC-F 250	250	2011	→	2013	FCD0151		FCD0151/1	FCS0151/2
XC-W 250 (2T)	250	2011	→	2012			FCD0502/1	FCS0502/3
XCF-W 250	250	2012	→	2013	FCD0151		FCD0151/1	FCS0151/2
XCF-W 250	250	2014	→				FCD0731/1	FCS0731/3
EXC 300 EGS	300	1994	→	1999			FCD0502/1	FCS0502/3
EXC 300	300	1994	→	2013			FCD0502/1	FCS0502/3
EXC 300 SIX DAYS (2T)	300	2006	→	2013			FCD0502/1	FCS0502/3
XC 300 (2T)	300	2011	→	2012			FCD0502/1	FCS0502/3
MC 340	340	1974	→	1983	FCD0584		FCS0584/2	
COUNTRY 350	350	1985	→		FCD0634		FCS0634/2	
EXC-F 350 SIX DAYS	350	2012	→	2013			FCD0731/1	FCS0731/3
EXC-F 350	350	2012	→	2014			FCD0731/1	FCS0731/3
GS 350	350	1983	→		FCD0634		FCS0634/2	
SX-F 350	350	2011	→	2012			FCD0731/1	FCS0731/3
XC-F 350	350	2011	→	2012			FCD0731/1	FCS0731/3
XCF-W 350	350	2011	→	2013			FCD0731/1	FCS0731/3
EGS 360	360	1996	→	1997			FCD0502/1	FCS0502/3
EXC 360	360	1996	→	1997			FCD0502/1	FCS0502/3
MXC 360	360	1996	→	1997			FCD0502/1	FCS0502/3
SIX DAYS 360	360	1996	→				FCD0502/1	FCS0502/3
SX 360	360	1996	→	1997			FCD0502/1	FCS0502/3

KTM

20024

FERODO
RACING
Updated on November 2020

FCDXXX
FCDXXX/1
FCSXXX/2
FCSXXX/3

STANDARD
HIGH PERFORMANCE
STANDARD
HIGH PERFORMANCE

FRICITION PLATES ONLY
FRICITION PLATES ONLY
FRICITION PLATES + STEEL PLATES
FRICITION PLATES + STEEL PLATES

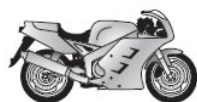

KIT RANGE



STANDARD HIGH PERFORMANCE



STANDARD HIGH PERFORMANCE

...KTM

EXC 380	380	1998	→	2002		FCD0502/1	FCS0502/3
MXC 380	380	1998	→	2002		FCD0502/1	FCS0502/3
SX 380	380	1998	→	2002		FCD0502/1	FCS0502/3
GS 390	390	1980	→		FCD0634		FCS0634/2
MC 390	390	1980	→		FCD0634		FCS0634/2
EXC 400	400	2000	→	2001	FCD0504	FCD0504/1	
EXC RACING 400	400	2000	→	2001	FCD0504	FCD0504/1	
EXC RACING 400	400	2002	→	2003		FCD0503/1	FCS0503/3
EXC 400	400	2002	→	2003		FCD0503/1	FCS0503/3
EXC RACING 400	400	2004	→	2005		FCD0673/1	FCS0673/3
EXC 400	400	2004	→			FCD0673/1	FCS0673/3
EXC RACING 400	400	2006	→	2007		FCD0713/1	FCS0713/3
EXC-G RACING 400	400	2004	→			FCD0673/1	FCS0673/3
EXC-G RACING 400	400	2006	→	2007		FCD0713/1	FCS0713/3
EXC-G RACING 400	400	2008	→		FCD0751	FCD0751/1	
LC4 400 EGS	400	1995	→	1997	FCD0505	FCD0505/1	
LC4 400 EXC - RXC	400	1996	→	1997	FCD0505	FCD0505/1	
LC4 400 E	400	1998	→	2001		FCD0654/1	FCS0654/3
MXC 400	400	2000	→	2001	FCD0504	FCD0504/1	
MXC 400	400	2002	→			FCD0503/1	FCS0503/3
SX 400	400	2000	→	2001	FCD0504	FCD0504/1	
SX 400	400	2002	→			FCD0503/1	FCS0503/3
SX RACING 400	400	2002	→			FCD0503/1	FCS0503/3
GS 420	420	1984	→		FCD0634		FCS0634/2
EXC RACING 450	450	2003	→			FCD0503/1	FCS0503/3
EXC RACING 450	450	2004	→	2005		FCD0673/1	FCS0673/3
EXC RACING 450	450	2006	→	2007		FCD0713/1	FCS0713/3
EXC-R 450	450	2008	→		FCD0751	FCD0751/1	
EXC-R 450	450	2009	→	2010		FCD0730/1	FCS0730/3
EXC-R RACING 450 (USA)	450	2011	→			FCD0730/1	FCS0730/3
EXC-R 450	450	2011	→		FCD0750	FCD0750/1	
MXC 450	450	2004	→	2005		FCD0673/1	FCS0673/3
MXC 450	450	2006	→			FCD0503/1	FCS0503/3
SMR 450 (FTE caliper)	450	2004	→	2006		FCD0673/1	FCS0673/3
SMR 450	450	2007	→	2007		FCD0713/1	FCS0713/3
SMR 450	450	2008	→	2012	FCD0707		
SX 450	450	2003	→			FCD0503/1	FCS0503/3
SX 450	450	2004	→	2005		FCD0673/1	FCS0673/3
SX SM 450 FACTORY REPLICA	450	2004	→			FCD0673/1	FCS0673/3
SX 450	450	2006	→			FCD0713/1	FCS0713/3
SX QUAD 450	450	2009	→	2011	FCD0709	FCD0709/1	
SX-F 450	450	2007	→	2011	FCD0709	FCD0709/1	
SX-F 450 FACTORY REPLICA	450	2012	→			FCD0731/1	FCS0731/3
SX-F 450	450	2012	→	2015		FCD0731/1	FCS0731/3
XC 450	450	2006	→	2007		FCD0713/1	FCS0713/3
XC-W 450	450	2008	→		FCD0751	FCD0751/1	
XC-W 450	450	2009	→	2010		FCD0730/1	FCS0730/3
XC-W 450 SIX DAYS (USA)	450	2011	→			FCD0730/1	FCS0730/3
XC-W 450	450	2011	→		FCD0750	FCD0750/1	
GS 495	495	1980	→		FCD0634		FCS0634/2
MX 495	495	1982	→	1983	FCD0634		FCS0634/2
EXC 500	500	2012	→	2013		FCD0731/1	FCS0731/3
XC-W 500	500	2012	→	2013		FCD0731/1	FCS0731/3
SX-F 505	505	2007	→	2009	FCD0709	FCD0709/1	
SX-F 505 QUAD	505	2009	→	2011	FCD0709	FCD0709/1	
XC-F 505	505	2007	→	2009	FCD0709	FCD0709/1	
EXC RACING 520	520	2000	→	2001	FCD0504	FCD0504/1	
EXC RACING 520	520	2002	→			FCD0503/1	FCS0503/3
MXC 520	520	2000	→	2001	FCD0504	FCD0504/1	
MXC 520	520	2002	→			FCD0503/1	FCS0503/3
SX 520	520	2000	→	2001	FCD0504	FCD0504/1	
SX 520	520	2002	→			FCD0503/1	FCS0503/3
EXC RACING 525	525	2003	→			FCD0503/1	FCS0503/3
EXC RACING 525	525	2004	→	2007		FCD0673/1	FCS0673/3
MXC 525	525	2003	→			FCD0503/1	FCS0503/3
MXC 525	525	2004	→	2005		FCD0673/1	FCS0673/3
SX 525	525	2003	→			FCD0503/1	FCS0503/3
SX 525	525	2004	→	2005		FCD0673/1	FCS0673/3
SX 525 SMR (FTE Caliper)	525	2004	→			FCD0673/1	FCS0673/3
SX 525	525	2006	→	2007		FCD0713/1	FCS0713/3
XC 525	525	2006	→	2007		FCD0713/1	FCS0713/3
EXC-R 530	530	2009	→	2010		FCD0730/1	FCS0730/3
EXC-R RACING 530 (USA)	530	2011	→			FCD0730/1	FCS0730/3
EXC-R 530	530	2011	→		FCD0750	FCD0750/1	
XC-W 530	530	2009	→	2010		FCD0730/1	FCS0730/3
XC-W 530 SIX DAYS (USA)	530	2011	→			FCD0730/1	FCS0730/3

FCDXXXX STANDARD FRICTION PLATES ONLY
 FCDXXXX/1 HIGH PERFORMANCE FRICTION PLATES ONLY
 FCSXXXX/2 STANDARD FRICTION PLATES + STEEL PLATES
 FCSXXXX/3 HIGH PERFORMANCE FRICTION PLATES + STEEL PLATES



20025

KTM

Updated on November 2020



KIT RANGE



STANDARD HIGH PERFORMANCE



STANDARD HIGH PERFORMANCE

...KTM

Model	Year	Year Range	Code	STANDARD	HIGH PERFORMANCE	STANDARD	HIGH PERFORMANCE
XC-W 530	530	2011 →		FCD0750	FCD0750/1		
LC4 540 SXC	540	1998 → 2000		FCD0505	FCD0505/1		
SMR 560	560	2006 → 2007			FCD0713/1		FCS0713/3
LC4 620 DUKE	620	1994 → 1997		FCD0505	FCD0505/1		
LC4 620 SX	620	1995 → 1999		FCD0505	FCD0505/1		
LC4 620 EGS - EXC	620	1996 → 1997		FCD0505	FCD0505/1		
LC4 620 RXC	620	1996 → 1997		FCD0505	FCD0505/1		
LC4 620 ADVENTURE	620	1997 → 1998		FCD0505	FCD0505/1		
LC4 620 SC	620	1998 → 2004			FCD0654/1		FCS0654/3
LC4 620 SMC	620	2004 → 2006			FCD0654/1		FCS0654/3
LC4 625 SXC	625	2003 → 2007			FCD0654/1		FCS0654/3
LC4 640 ADVENTURE	640	1998 → 2003			FCD0654/1		FCS0654/3
LC4 640 DUKE	640	1998 →			FCD0654/1		FCS0654/3
LC4 E 640 HARD ENDURO	640	1998 → 2006			FCD0654/1		FCS0654/3
LC4 640 DUKE II	640	1999 → 2006			FCD0654/1		FCS0654/3
LC4-E 640 SUPERMOTO	640	1999 → 2006			FCD0654/1		FCS0654/3
LC4 640 ADVENTURE	640	2004 → 2007			FCD0654/1		FCS0654/3
LC4-E 660 RALLYE	660	2001 →			FCD0712/1		FCS0712/3
LC4 660 SM FACTORY REPLICA	660	2002 → 2003			FCD0654/1		FCS0654/3
SMC 660 SUPERMOTO	660	2003 →			FCD0654/1		FCS0654/3
SMC 660 SUPERMOTO	660	2004 → 2006			FCD0654/1		FCS0654/3
LC4 690 RALLY REPLICA	690	2007 → 2010			FCD0712/1		FCS0712/3
LC4 690 SM	690	2007 → 2009			FCD0710/1		FCS0710/3
LC4 690 SM PRESTIGE	690	2007 →			FCD0710/1		FCS0710/3
LC4 690 DUKE	690	2008 → 2011			FCD0710/1		FCS0710/3
LC4 690 ENDURO	690	2008 → 2011			FCD0710/1		FCS0710/3
LC4 690 SMC	690	2008 → 2011			FCD0710/1		FCS0710/3
LC4 690 SMR	690	2008 →			FCD0710/1		FCS0710/3
LC4 690 ENDURO R	690	2009 → 2012			FCD0710/1		FCS0710/3
LC4 690 DUKE R	690	2010 → 2011			FCD0710/1		FCS0710/3
LC4 690 SMC R	690	2012 →			FCD0710/1		FCS0710/3
LC8 950 ADVENTURE	950	2003 → 2005			FCD0711/1		FCS0711/3
LC8 950 ADVENTURE S	950	2003 → 2005			FCD0711/1		FCS0711/3
LC8 950 SM	950	2005 → 2008			FCD0711/1		FCS0711/3
LC8 950 SUPERENDURO	950	2006 → 2008			FCD0711/1		FCS0711/3
LC8 950 SUPERENDURO R	950	2006 → 2008			FCD0711/1		FCS0711/3
LC8 950 SMR	950	2007 →			FCD0711/1		FCS0711/3
LC8 990 SUPERDUKE	990	2005 → 2012			FCD0711/1		FCS0711/3
LC8 990 ADVENTURE	990	2006 → 2012			FCD0711/1		FCS0711/3
LC8 990 ADVENTURE S	990	2006 → 2008			FCD0711/1		FCS0711/3
LC8 990 SUPERDUKE R	990	2007 → 2012			FCD0711/1		FCS0711/3
LC8 990 SUPERMOTO	990	2008 → 2009			FCD0711/1		FCS0711/3
LC8 990 ADVENTURE DAKAR	990	2009 → 2012			FCD0711/1		FCS0711/3
LC8 990 ADVENTURE R	990	2009 → 2012			FCD0711/1		FCS0711/3
LC8 990 SUPERMOTO T	990	2009 → 2012			FCD0711/1		FCS0711/3
RC8 1190	1190	2008 → 2010		FCD0729	FCD0729/1		
RC8 1190 R	1190	2009 → 2012		FCD0729	FCD0729/1		
RC8 1190 R TRACK	1190	2011 →		FCD0729	FCD0729/1		

LEM

BIG 50 SAFARI	50	→	FSS0520	FCD0548		FCS0548/2	
CINNO 50 CROSS MX 3L	50	→	FSS0520	FCD0548		FCS0548/2	
CINNO 50 TRIAL	50	→	FSS0520	FCD0548		FCS0548/2	
FORMULA 50	50	→	FSS0520	FCD0548		FCS0548/2	
FORMULA 50 T4 ACQUA	50	→	FSS0520	FCD0548		FCS0548/2	

MALAGUTI

DRIBBLING 50 all models	50	1987 →	FSS0520	FCD0548		FCS0548/2	
DUNE 50 ENDURO	50	1987 →		FCD0523	FCD0523/1	FCS0523/2	FCS0523/3
ES 50 DUNE	50	1989 →		FCD0523	FCD0523/1	FCS0523/2	FCS0523/3
FIFTY 50 HF	50	→ 1982		FCD0615	FCD0615/1	FCS0615/2	
FIFTY 50 FULL all models	50	1983 →		FCD0615	FCD0615/1	FCS0615/2	
FIFTY 50 TOP	50	1985 →		FCD0615	FCD0615/1	FCS0615/2	
FIFTY 50 4 MARCE	50	1987 →		FCD0615	FCD0615/1	FCS0615/2	
FIFTY 50 HF	50	1987 →		FCD0615	FCD0615/1	FCS0615/2	
FIFTY 50 NL	50	1987 →		FCD0615	FCD0615/1	FCS0615/2	
FIFTY 50 RV	50	1987 →		FCD0615	FCD0615/1	FCS0615/2	
FIFTY 50 RV VARIATORE / KICK	50	1987 →		FCD0615	FCD0615/1	FCS0615/2	
GRIZZLY 50 all models	50	1987 →	FSS0520	FCD0548		FCS0548/2	
MDX GOLD 50 ENDURO	50	1987 →		FCD0615	FCD0615/1	FCS0615/2	
MEX 50 ENDURO	50	1985 →		FCD0615	FCD0615/1	FCS0615/2	
MGX 50 ENDURO	50	1987 →	FSS0520	FCD0548		FCS0548/2	
MLX 50 ENDURO	50	1987 →		FCD0615	FCD0615/1	FCS0615/2	
RCW 50 RONCO	50	→ 1982	FSS0520	FCD0548		FCS0548/2	

20026



FCDXXX
FCDXXX/1
FCSXXX/2
FCSXXX/3

STANDARD
HIGH PERFORMANCE
STANDARD
HIGH PERFORMANCE

FRICITION PLATES ONLY
FRICITION PLATES ONLY
FRICITION PLATES + STEEL PLATES
FRICITION PLATES + STEEL PLATES

KTM

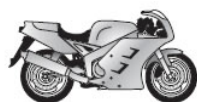

KIT RANGE

STANDARD
HIGH PERFORMANCESTANDARD
HIGH PERFORMANCE

...MALAGUTI

RCX-W 50 ENDURO	50	1983 →	FSS0520	FCD0548		FCS0548/2	
RGT 50 STRADA	50	1983 →	FSS0520	FCD0548		FCS0548/2	
RGT 50 SPORT	50	1985 →	FSS0520	FCD0548		FCS0548/2	
RST 50 SPORT tutti i tipi	50	1987 →	FSS0520	FCD0548		FCS0548/2	
SAHIB 50 ENDURO	50	1983 →	FSS0520	FCD0548		FCS0548/2	
CHOPPER 80	80	→ 1982		FCD0615	FCD0615/1	FCS0615/2	
MDX 80 ENDURO	80	1984 →		FCD0523	FCD0523/1	FCS0523/2	FCS0523/3

MALANCA

1 coperchio friz. perno corto	1	→		FCD0637			
1 coperchio friz. perno lungo	1	→		FCD0646			

MINARELLI

motore AM 345 - AM 6 50 cc	50	→	FSS0518	FCD0608	FCD0608/1	FCS0608/2	FCS0608/3
motore HF R 3 GL 50 cc	50	→	FSS0506	FCD0636		FCS0636/2	
motore P4 50 cc	50	→		FCD0621			
motore P6 50 cc	50	→		FCD0587			
motore RV 4 50 cc	50	→	FSS0506	FCD0636		FCS0636/2	
motore MR 6 80 cc	80	→		FCD0635			
motore 125 cc	125	→		FCD0541			
motore RK 6 125 cc	125	→		FCD0531			

MONTESA

MKS 50	50	1987 →		FCD0587			
COTA 123	123	→ 1983					
COTA 123	123	1983 →					
MH 123	123	1983 →					
MH 200	200	1983 →					
COTA 242	242	1983 →					
RC 248	248	→					
COTA 304	304	1987 →					
COTA 304	304	1988 →					
COTA 307	307	1989 →					
COTA 315	315	1997 → 1999		FCD0544			
COTA 330	330	→					
TRIAL 330	330	1985 →					
COTA 335	335	→					
COTA 335	335	1987 → 1991					
T 348	348	→ 1983					
COTA 349	349	1983 →					
MH 349	349	1983 →					

MORINI FRANCO

motore 2-3 marce 50 cc	50	→		FCD0618			
motore 6 M 50 cc	50	→	FSS0513	FCD0509			
motore T4 - TA5 6 marce 50 cc	50	→	FSS0520	FCD0548		FCS0548/2	
motore TOP G 60 50 cc	50	→	FSS0520	FCD0548		FCS0548/2	

MOTO GUZZI

NEVADA 350	350	1992 → 1997		FCD0571			
NEVADA 350 CLUB	350	1998 → 1999		FCD0571			
NTX 350	350	1986 → 1990		FCD0543			
V 35 350 (accensione elettronica)	350	1977 → 1979		FCD0543			
V 35 350 II	350	1980 → 1985		FCD0543			
V 35 350 C	350	1982 → 1986		FCD0543			
V 35 350 III	350	1985 → 1987		FCD0543			
V 35 350 FLORIDA	350	1986 → 1990		FCD0543			
V 35 350 CARABINIERI	350	1990 → 1991		FCD0543			
V 35 350 CARABINIERI	350	1992 → 2001		FCD0571			
V 50 500 (accensione elettronica)	500	1977 → 1979		FCD0543			
V 50 500 III	500	1980 → 1984		FCD0543			
V 50 500 C	500	1982 → 1986		FCD0543			
V 50 500 III POLIZIA (vecchio tipo)	500	1982 → 1990		FCD0543			
V 50 500 PA	500	1992 → 2001		FCD0571			
65 GT 650	650	1988 → 1989		FCD0571			
NTX 650	650	1986 → 1990		FCD0543			
V 65 650 CUSTOM	650	1983 → 1986		FCD0571			
V 65 650 FLORIDA	650	1985 → 1992		FCD0571			
V 65 650 POLIZIA (nuovo tipo)	650	1988 → 1995		FCD0571			
BREVA 750	750	2003 → 2007		FCD0571			

FCDXXXX
FCDXXXX/1
FCSXXXX/2
FCSXXXX/3

STANDARD
HIGH PERFORMANCE
STANDARD
HIGH PERFORMANCE

FRICION PLATES ONLY
FRICION PLATES ONLY
FRICION PLATES + STEEL PLATES
FRICION PLATES + STEEL PLATES

FERODO
RACING
Updated on November 2020

20027



KIT RANGE



STANDARD

HIGH PERFORMANCE



STANDARD

HIGH PERFORMANCE

...MOTO GUZZI

NEVADA 750	750	1991 → 1997			FCD0571		
NEVADA 750 CLUB	750	1998 → 2001			FCD0571		
NEVADA 750	750	2002 → 2003			FCD0571		
NEVADA 750 CLASSIC	750	2004 → 2007			FCD0571		
NEVADA 750 AQUILA NERA	750	2009 → 2010			FCD0571		
NEVADA 750 CLASSIC	750	2009 → 2012			FCD0571		
NEVADA 750 S	750	2010 →			FCD0571		
NEVADA 750 S ANNIVERSARIO	750	2012 →			FCD0571		
750 POLIZIA 1A e 2A serie	750	1992 → 2002			FCD0571		
SP 750	750	1990 → 1992			FCD0571		
STRADA 750	750	1993 → 1995			FCD0571		
TARGA 750	750	1990 → 1992			FCD0571		
V7 750 CLASSIC	750	2008 → 2012			FCD0571		
V7 750 CAFE CLASSIC	750	2009 →			FCD0571		
V7 750 RACER	750	2011 →			FCD0571		
V7 750 SPECIAL - STONE	750	2012 →			FCD0571		
V 75 750 PA	750	1992 → 2001			FCD0571		
BREVA 850	850	2006 → 2007			FCD0612		
GRISO 850	850	2006 → 2007			FCD0612		
LE MANS III 850	850	1981 → 1984			FCD0513		
NORGE 850	850	2007 → 2008			FCD0612		
T3 850	850	1979 → 1985			FCD0513		
T5 850 CIVILE	850	1984 → 1987			FCD0513		
T5 850 POLIZIA	850	1988 → 2001			FCD0612		
T5 850 POLIZIA (ante modifica)	850	1988 → 1993			FCD0513		
BELLAGIO 940 AQUILA NERA	940	2007 → 2010			FCD0612		
CALIFORNIA II 1000	1000	1981 → 1987			FCD0513		
CALIFORNIA III 1000 (carburatori)	1000	1987 →			FCD0612		
CALIFORNIA III 1000 (carburatori)	1000	1988 → 1993			FCD0513		
CALIFORNIA III 1000 (iniezione)	1000	1990 → 1993			FCD0612		
DAYTONA 1000	1000	1992 → 1995			FCD0612		
DAYTONA 1000 RACING	1000	1996 →			FCD0612		
DAYTONA 1000 RS	1000	1997 → 1998			FCD0612		
GT 1000	1000	1987 → 1991			FCD0612		
LE MANS 1000	1000	1984 → 1993			FCD0612		
QUOTA 1000	1000	1992 → 1997			FCD0612		
S 1000	1000	1989 → 1994			FCD0612		
SP 1000	1000	1979 → 1983			FCD0513		
SP II 1000	1000	1984 → 1987			FCD0513		
SP III 1000	1000	1989 → 1994			FCD0612		
STRADA 1000	1000	1993 → 1994			FCD0612		
V 10 1000 CENTAURO	1000	1997 → 1999			FCD0612		
BREVA 1100	1100	2005 → 2007			FCD0612		
CALIFORNIA 1100	1100	1994 → 1997			FCD0612		
CALIFORNIA 1100 EV	1100	1997 → 2002			FCD0612		
CALIFORNIA 1100 JACKAL	1100	1999 →			FCD0612		
CALIFORNIA 1100 SPECIAL	1100	1999 → 2000			FCD0612		
CALIFORNIA 1100 SPORT	1100	2001 → 2002			FCD0612		
CALIFORNIA 1100 STONE - METAL	1100	2001 → 2005			FCD0612		
CALIFORNIA 1100 SPECIAL SPORT - ALLUMINIUM	1100	2002 → 2003			FCD0612		
CALIFORNIA 1100 EV TOURING	1100	2003 → 2005			FCD0612		
CALIFORNIA 1100 EV	1100	2003 → 2005			FCD0612		
CALIFORNIA 1100 ALLUMINIUM - TITANIUM	1100	2004 → 2005			FCD0612		
CALIFORNIA 1100	1100	2006 → 2012			FCD0612		
CALIFORNIA 1100 CLASSIC - TOURING	1100	2006 → 2008			FCD0612		
CALIFORNIA 1100 VINTAGE	1100	2006 → 2012			FCD0612		
CALIFORNIA 1100 AQUILA NERA	1100	2009 → 2011			FCD0612		
GRISO 1100	1100	2005 → 2008			FCD0612		
QUOTA 1100 ES	1100	1999 → 2001			FCD0612		
SPORT 1100 (carburatori)	1100	1994 → 1996			FCD0612		
SPORT 1100 (iniezione)	1100	1996 → 1999			FCD0612		
SPORT 1100 CORSA	1100	1998 → 1999			FCD0612		
V 11 1100 SPORT	1100	1999 → 2005			FCD0612		
V 11 1100 LE MANS	1100	2001 → 2005			FCD0612		
V 11 1100 NAKED	1100	2003 → 2005			FCD0612		
V11 1100 BALLABIO	1100	2003 → 2005			FCD0612		
V11 1100 CAFE SPORT	1100	2003 → 2005			FCD0612		
V11 1100 COPPA ITALIA	1100	2003 → 2005			FCD0612		
BREVA 1200 V	1200	2008 →			FCD0612		
NORGE 1200	1200	2006 → 2007			FCD0612		
NORGE 1200 ABS	1200	2006 → 2007			FCD0612		
SPORT 1200	1200	2006 → 2008			FCD0612		
SPORT 1200 ABS	1200	2006 → 2007			FCD0612		

20028

FERODO

RACING

Updated on November 2020

FCDXXXX
FCDXXXX/1
FCSXXXX/2
FCSXXXX/3STANDARD
HIGH PERFORMANCE
STANDARD
HIGH PERFORMANCEFRICTION PLATES ONLY
FRICTION PLATES ONLY
FRICTION PLATES + STEEL PLATES
FRICTION PLATES + STEEL PLATES

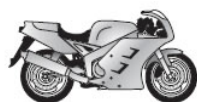

KIT RANGE



HIGH PERFORMANCE



HIGH PERFORMANCE

MOTO MORINI

				STANDARD	HIGH PERFORMANCE	STANDARD	HIGH PERFORMANCE
COGAURO 350	350	1990	→	FCD0547			
DART 350	350	1988	→	FCD0547			
EXCALIBUR 350	350	1986	→ 1989	FCD0547			
EXALIBUR RLX 350	350	1990	→	FCD0547			
GT 350	350	1976	→ 1981	FCD0547			
GT 350	350	1979	→	FCD0547			
GT 350 TURISMO	350	1980	→	FCD0547			
K2 350	350	1984	→	FCD0547			
KANGURO 350	350	1983	→	FCD0547			
MORINI 350	350		→	FCD0547			
NEW YORK 350	350	1989	→	FCD0547			
SPORT 350	350	1980	→ 1982	FCD0547			
WS 350 PRO ACTION	350	1993	→	FCD0547			
XE 350	350	1985	→	FCD0547			
DART 400	400	1990	→	FCD0547			
CAMEL 500	500	1981	→	FCD0547			
T.T. 500	500	1980	→	FCD0547			
CAMEL 501	501	1985	→	FCD0547			
COGUARO 501	501	1989	→	FCD0547			
EXCALIBUR 501	501	1986	→	FCD0547			
NEW YORK 501	501	1989	→	FCD0547			

MV AGUSTA

BRUTALE 675 (35kw)	675	2011	→ 2013		FCD0690/1		FCS0690/3
BRUTALE 675 S	675	2011	→ 2013		FCD0690/1		FCS0690/3
F3 675 S	675	2011	→ 2012		FCD0690/1		FCS0690/3
F3 675 SERIE ORO	675	2011	→ 2013		FCD0690/1		FCS0690/3
F3 675	675	2013	→ 2014		FCD0690/1		FCS0690/3
BRUTALE 750 S	750	2003	→ 2005		FCD0694/1		
BRUTALE 750 SERIE ORO	750	2003	→ 2005		FCD0694/1		
F4 750 S - S 1+1	750	1998	→ 2004		FCD0694/1		
F4 750 SERIE ORO	750	1998	→ 2004		FCD0694/1		
BRUTALE 800	800	2013	→	FCD0693	FCD0693/1		
F3 800	800	2013	→	FCD0693	FCD0693/1		
RIVALE 800	800	2013	→	FCD0693	FCD0693/1		
BRUTALE 910	910	2005	→ 2008		FCD0695/1		
BRUTALE 910 R	910	2005	→ 2008		FCD0695/1		
BRUTALE 910 S	910	2005	→ 2008		FCD0695/1		
BRUTALE 920	920	2011	→ 2014	FCD0691			
BRUTALE 989 S	989	2008	→ 2009	FCD0691			
BRUTALE 990 S	990	2010	→ 2011	FCD0691			
F4 1000 S- S 1+1 - AGO - TAMBURINI - STOCK	1000	2002	→ 2005		FCD0695/1		
F4 1000	1000	2004	→ 2006		FCD0695/1		
F4 1000 S - R - RR - S 1+1 - R 1+1 - RR 1+1	1000	2006	→ 2007	FCD0691			
F4 1000 SENNA	1000	2006	→	FCD0691			
F4 1000 STOCK - VELTRO- SBK Replica	1000	2006	→	FCD0691			
F4 1000 STOCK - VELTRO- SBK Replica	1000	2007	→ 2008	FCD0691			
F4 1000 312 R- 312 R 1+1- STOCK 312	1000	2008	→	FCD0691			
F4 1000 R- RR- TRICOLORE - ECOLE DE CHASSE	1000	2010	→ 2013	FCD0691			
BRUTALE 1078 R	1078	2008	→ 2009	FCD0691			
F4 1078 312 R - 312 R 1+1	1078	2008	→	FCD0691			
BRUTALE 1090 R	1090	2010	→ 2013	FCD0691			
BRUTALE 1090 RR	1090	2012	→ 2013	FCD0691			
BRUTALE 1090 RR Corsa	1090	2013	→	FCD0691			

NSU-PUCH

NSU-PUCH 1 (2 dischi)	1		→	FCD0566			
NSU-PUCH 1 (3 dischi)	1		→	FCD0666			

OHVALE

GP-O 110 4 SPEED	110	2017	→ 2019	FCD1334	FCD1334/1	FCS1334/2	FCS1334/3
GP-O 160 4 SPEED	160	2017	→ 2019	FCD1335	FCD1335/1		
GP-O 190 DAYTONA	190	2017	→ 2019	FCD1319	FCD1319/1	FCS1319/2	FCS1319/3

PEUGEOT

103/104/105	50	1976	→	FCD0560			
-------------	----	------	---	---------	--	--	--

FCDXXXX STANDARD FRICTION PLATES ONLY
 FCDXXXX/1 HIGH PERFORMANCE FRICTION PLATES ONLY
 FCSXXXX/2 STANDARD FRICTION PLATES + STEEL PLATES
 FCSXXXX/3 HIGH PERFORMANCE FRICTION PLATES + STEEL PLATES

FERODO
 RACING
 Updated on November 2020

20029



KIT RANGE



HIGH PERFORMANCE



HIGH PERFORMANCE

PIAGGIO

					STANDARD	HIGH PERFORMANCE	STANDARD	HIGH PERFORMANCE
BOXER 50 (massette avviamento)	50	→			FCD0604			
BOXER 50 (massette frizione)	50	→			FCD0535			
BOXER variatore 50 (massette avviamento)	50	→			FCD0579			
BRAVO 50 (massette avviamento)	50	→			FCD0604			
BRAVO 50 (massette frizione)	50	→			FCD0535			
BRAVO variatore 50 (massette avviamento)	50	→			FCD0579			
BRAVO 50 (ruote in lega mozzo 90mm) (massette avviamento)	50	1987 →			FCD0604			
BRAVO 50 (ruote in lega mozzo 90mm) (massette frizione)	50	1987 →			FCD0535			
BRAVO 50 (ruote in lega) (massette avviamento)	50	1987 →			FCD0604			
BRAVO 50 (ruote in lega) (massette frizione)	50	1987 →			FCD0535			
BRAVO variatore 50 (ruote in lega mozzo 90mm) (massette avviamento)	50	1987 →			FCD0579			
BRAVO variatore 50 (ruote in lega) (massette avviamento)	50	1987 →			FCD0579			
CIAO 50 (massette avviamento)	50	→			FCD0604			
CIAO 50 (massette frizione)	50	→			FCD0535			
CIAO variatore 50 (massette avviamento)	50	→			FCD0579			
CIAO 50 (ruote in lega) (massette avviamento)	50	1987 →			FCD0604			
CIAO 50 (ruote in lega) (massette frizione)	50	1987 →			FCD0535			
CIAO variatore 50 (ruote in lega) (massette avviamento)	50	1987 →			FCD0579			
GRILLO 50 (massette avviamento)	50	1989 →			FCD0604			
GRILLO 50 (massette frizione)	50	1989 →			FCD0535			
GRILLO variatore 50 (massette avviamento)	50	1989 →			FCD0579			
SI 50 (massette avviamento)	50	→			FCD0604			
SI 50 (massette frizione)	50	→			FCD0535			
SI variatore 50 (ruote in lega) (massette avviamento)	50	1980 →			FCD0579			
VESPA 50 SPECIAL	50	1963 →	FSS0502		FCD0578		FCS0578/2	
VESPA 50 L - N	50	1963 →	FSS0502		FCD0578		FCS0578/2	
VESPA 50 PK	50	1983 →	FSS0502		FCD0578		FCS0578/2	
VESPA 50 PK SPECIAL - XL	50	1986 →	FSS0502		FCD0578		FCS0578/2	
VESPA 50 PK XL 2	50	1986 →	FSS0502		FCD0578		FCS0578/2	
VESPA 50 PK XL 2 AUTOMATICA	50	1986 →	FSS0502		FCD0578		FCS0578/2	
VESPA 50 V FL 2	50	1990 →	FSS0516		FCD0507		FCS0507/2	
VESPA 50 HP FL2	50	1992 →	FSS0516		FCD0507		FCS0507/2	
VESPA 80 PX (Spagna)	80	→	FSS0502		FCD0578		FCS0578/2	
VESPA 80 SPECIAL (Spagna)	80	→	FSS0502		FCD0578		FCS0578/2	
VESPA 80 (Spagna)	80	→	FSS0502		FCD0578		FCS0578/2	
VESPA 90 PRIMAVERA	90	1958 →	FSS0502		FCD0578		FCS0578/2	
VESPA 98	98	1946 → 1947	FSS0218		FCD0723		FCS0723/2	
COSA 125 CL / CL2	125	1988 → 1991	FSS0521		FCD0554		FCS0554/2	
COSA 2 125	125	1991 → 1997	FSS0131		FCD0518	FCD0518/1	FCS0518/2	FCS0518/3
VESPA 125 ET3	125	→	FSS0502		FCD0578		FCS0578/2	
VESPA 125 PX (Spagna)	125	→	FSS0519		FCD0607		FCS0607/2	
VESPA 125 (da V1T a V15T - da V30T a V33T)	125	1946 → 1952	FSS0218		FCD0723		FCS0723/2	
VESPA 125 (VM1/2T - VU1T)	125	1953 → 1954	FSS0218		FCD0722		FCS0722/2	
VESPA 125 (VN1/2T)	125	1955 → 1957	FSS0519		FCD0721		FCS0721/2	
VESPA 125	125	1958 → 1972	FSS0519		FCD0607		FCS0607/2	
VESPA 125 GT (VNL2T)	125	1966 → 1973	FSS0519		FCD0607		FCS0607/2	
VESPA 125 PRIMAVERA (1 serie)	125	1966 →	FSS0502		FCD0578		FCS0578/2	
VESPA 125 PRIMAVERA	125	1967 → 1973	FSS0502		FCD0578		FCS0578/2	
VESPA 125 GTR (VNL2T)	125	1968 → 1978	FSS0519		FCD0607		FCS0607/2	
VESPA 125 PX	125	1978 → 1981	FSS0519		FCD0607		FCS0607/2	
VESPA 125 PX ARCOBALENO	125	1983 →	FSS0519		FCD0607		FCS0607/2	
VESPA 125 ETS	125	1984 →	FSS0502		FCD0578		FCS0578/2	
VESPA 125 PK AUTOMATICA	125	1984 →	FSS0502		FCD0578		FCS0578/2	
VESPA 125 PK XL 2	125	1984 →	FSS0502		FCD0578		FCS0578/2	
VESPA 125 PK SPECIAL - XL	125	1986 → 1989	FSS0502		FCD0578		FCS0578/2	
VESPA 125 V FL2	125	1991 →	FSS0516		FCD0507		FCS0507/2	
VESPA 125 PX	125	1998 →	FSS0131		FCD0518	FCD0518/1	FCS0518/2	FCS0518/3
COSA 150 CL / CLX	150	1988 → 1991	FSS0521		FCD0554		FCS0554/2	
COSA 2 150	150	1991 → 1997	FSS0131		FCD0518	FCD0518/1	FCS0518/2	FCS0518/3
VESPA 150 PX (Spagna)	150	→	FSS0519		FCD0607		FCS0607/2	
VESPA 150 (VL1/2/3T)	150	1955 → 1957	FSS0519		FCD0721		FCS0721/2	
VESPA 150 GS (VS1)	150	1955 →	FSS0519		FCD0724		FCS0724/2	
VESPA 150 GS (VS2/3/4)	150	1956 → 1958	FSS0519		FCD0725		FCS0725/2	
VESPA 150 GS (VS5 da tel 47351 a tel 63168)	150	1959 → 1961	FSS0519		FCD0725		FCS0725/2	
VESPA 150	150	1963 → 1972	FSS0519		FCD0607		FCS0607/2	
VESPA 150 SPRINT VELOCE (VLB1)	150	1965 → 1974	FSS0519		FCD0607		FCS0607/2	
VESPA 150 SUPER (VBC1T)	150	1965 → 1966	FSS0519		FCD0607		FCS0607/2	
VESPA 150 TS (VNL3T)	150	1975 → 1978	FSS0519		FCD0607		FCS0607/2	
VESPA 150 PX	150	1978 → 1991	FSS0519		FCD0607		FCS0607/2	
VESPA 150 PX ARCOBALENO	150	1983 → 1997	FSS0519		FCD0607		FCS0607/2	
VESPA 150 PX	150	1998 →	FSS0131		FCD0518	FCD0518/1	FCS0518/2	FCS0518/3
VESPA 160 GS	160	1975 →	FSS0519		FCD0607		FCS0607/2	
VESPA 180 SS	180	1975 →	FSS0521		FCD0554		FCS0554/2	
COSA 200	200	1989 → 1991	FSS0521		FCD0554		FCS0554/2	
COSA 1 200	200	1989 → 1991	FSS0521		FCD0554		FCS0554/2	
COSA 2 200	200	1991 → 1997	FSS0131		FCD0518	FCD0518/1	FCS0518/2	FCS0518/3

20030

FERODO

RACING

Updated on November 2020

FCDXXXX
 FCDXXXX/1
 FCSXXXX/2
 FCSXXXX/3

STANDARD
 HIGH PERFORMANCE
 STANDARD
 HIGH PERFORMANCE

FRICITION PLATES ONLY
 FRICITION PLATES ONLY
 FRICITION PLATES + STEEL PLATES
 FRICITION PLATES + STEEL PLATES

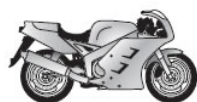

KIT RANGE



STANDARD
HIGH PERFORMANCE



STANDARD
HIGH PERFORMANCE

...PIAGGIO

Model	Capacity	Year	Code	FSS	FCD	Kit	FCS
VESPA 200 RALLY	200	1975 →		FSS0521	FCD0554		FCS0554/2
VESPA 200 PX E	200	1978 →		FSS0521	FCD0554		FCS0554/2
VESPA 200 PE	200	1983 →		FSS0521	FCD0554		FCS0554/2
VESPA 200 PX ARCOBALENO	200	1983 →		FSS0521	FCD0554		FCS0554/2
VESPA 200 PX	200	1998 →		FSS0131	FCD0518	FCD0518/1	FCS0518/2 FCS0518/3

PIAGGIO (motocarri)

APE 50 P	50	1980 → 1985		FSS0502	FCD0578		FCS0578/2
APE 50 TM P	50	1985 → 1989		FSS0502	FCD0578		FCS0578/2
APE 50 FL / FL2	50	1989 → 1995		FSS0516	FCD0507		FCS0507/2
APE 50 FL3 EUROPA	50	1996 → 1999		FSS0516	FCD0507		FCS0507/2
APE 50 RST MIX	50	1999 → 2005		FSS0516	FCD0507		FCS0507/2
APE 50 EURO 2	50	2003 → 2010		FSS0516	FCD0507		FCS0507/2
APE PENTARO' 175 con scodellino	175	→			FCD0611		
APE PENTARO' 175 senza scodellino	175	→			FCD0511		
APE PENTARO' 175 senza mozzo	175	→			FCD0511		
APE LS 220 lubrificazione separata	220	→			FCD0515		
APE MP 220 P 501 (I SERIE) con scodellino	220	→			FCD0611		
APE MP 220 P 501 (I SERIE) senza scodellino	220	→			FCD0511		
APE LS 220 lubrificazione sep. senza mozzo	220	→			FCD0515		
APE MP 220 P 501 (I SERIE) senza mozzo	220	→			FCD0511		
APE CAR 220 P2 / P3	220	1978 → 1985			FCD0536		
APE MP 220 P 501 (II SERIE)	220	1978 → 1996			FCD0542		
APE MP 220 P 601 (I SERIE)	220	1978 →			FCD0515		
APE MP 220 P 601 (II SERIE)	220	1978 → 1996			FCD0536		
APE MP 220 P 601 (I SERIE) senza mozzo	220	1978 →			FCD0515		
APE TM 220 P 602	220	1982 → 1983			FCD0536		
APE TM 220 P 703 / P 703 V / FL2	220	1984 → 2002			FCD0536		
APE TM 220	220	2009 → 2010			FCD0536		
APE CAR 420 MAX DIESEL 9 q.li	420	1986 → 1996			FCD0508		
APE CAR 420 DIESEL	420	1986 → 1996			FCD0508		
APE TM 420 P 703 / P 703 V DIESEL	420	1987 → 2004			FCD0508		
APE POKER 420 BENZINA	420	1993 →			FCD0508		
APE POKER 420 DIESEL	420	1993 → 1997			FCD0508		
APE TM 420 DIESEL LCS	420	2005 → 2010			FCD0508		
APE MP 420 601 CLASSIC	420	2006 → 2007			FCD0508		
APE CALESSINO 420	420	2007 → 2008			FCD0508		
PORTER 500 QUARGO	500	2005 → 2009			FCD0683		
PORTER 1000 (carbурatore)	1000	1992 →			FCD0602		
PORTER 1000 (iniezione)	1000	1992 → 1998			FCD0514		
PORTER 1200 DIESEL	1200	1995 → 2000			FCD0500		
PORTER 1300 16 V 4X4	1300	1998 → 2007			FCD0600		
PORTER 1300 16 V MAXXI	1300	1998 → 2007			FCD0600		
PORTER 1300 16 V PICK UP	1300	1998 → 2007			FCD0600		
PORTER 1300 16 V VAN	1300	1998 → 2007			FCD0600		
PORTER 1300 MAXXI UP - DATE	1300	2009 →			FCD0600		
PORTER 1300 UP - DATE	1300	2009 →			FCD0600		
PORTER 1400 DIESEL	1400	1995 → 2000			FCD0500		

PUCH

CONDOR 50	50	→			FCD0566		
DS 50	50	→			FCD0566		
IMOLA 50	50	→			FCD0566		
M 50	50	→			FCD0566		
MC 50	50	→			FCD0566		
MONZA 50	50	1983 → 1984			FCD0566		
MONZA 50	50	1985 →			FCD0566		
MS 50	50	→			FCD0566		
MV 50	50	→			FCD0566		
RANGER 50	50	→			FCD0566		
VZ 50	50	→			FCD0566		

RIEJU

DRAC 50 (SPAIN)	50	→		FSS0518	FCD0608	FCD0608/1	FCS0608/2 FCS0608/3
DRAC 50	50	1992 →		FSS0506	FCD0636		FCS0636/2
FD4 50 SUPER MARATON	50	1985 →		FSS0506	FCD0636		FCS0636/2
MARATHON 50	50	1974 →			FCD0587		
MRT-PRO 50	50	2009 → 2010		FSS0506	FCD0636		FCS0636/2
MRX 50 RACING	50	2002 →			FCD0635		
MRX 50 PRO	50	2005 →			FCD0635		
NKD 50	50	2005 →			FCD0635		
RS1 50	50	1989 →		FSS0506	FCD0636		FCS0636/2

FCDXXXX STANDARD FRICTION PLATES ONLY
 FCDXXXX/1 HIGH PERFORMANCE FRICTION PLATES ONLY
 FCSXXXX/2 STANDARD FRICTION PLATES + STEEL PLATES
 FCSXXXX/3 HIGH PERFORMANCE FRICTION PLATES + STEEL PLATES

FERODO
 RACING
 Updated on November 2020

20031

RIEJU

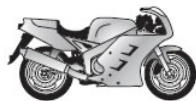

KIT RANGE



STANDARD

HIGH PERFORMANCE



STANDARD

HIGH PERFORMANCE

...RIEJU

RS1 50 EVOLUTION	50	1996 → 2000	FSS0518	FCD0608	FCD0608/1	FCS0608/2	FCS0608/3
RS1 50 CASTROL	50	2001 →	FSS0518	FCD0608	FCD0608/1	FCS0608/2	FCS0608/3
RS2 50 MATRIX	50	2003 →	FSS0518	FCD0608	FCD0608/1	FCS0608/2	FCS0608/3

ROTAX

motori 175	175	1983 →		FCD0580			
motori 360	360	1985 →		FCD0516			
motori 440	440	1985 →		FCD0516			

SACHS

motore 3M 50	50	→		FCD0567			
motore 504 50	50	→		FCD0630			
EKF ENGINE 50 4/5/6 SPEED (3 discs)	50	→		FCD0591			
EKF ENGINE 50 4/5/6 SPEED (5 discs)	50	→		FCD0591			
SACHS-CASAL 50	50	→		FCD0670			
X ROAD 125	125	2005 →		FCD0301			
XTC 125	125	2000 → 2007		FCD0301			

SUZUKI

FR 50	50	1974 → 1981		FCD0373			
GS 50	50	2005 →	FSS0302	FCD0303			
GT 50	50	1977 → 1980	FSS0401	FCD0303			
JR 50 all models	50	1978 → 2007	FSS0201	FCD0319			
OR 50 ET	50	1980 →	FSS0401	FCD0303			
RB 50 H	50	1987 →	FSS0401	FCD0361			
RG 50 EW	50	→	FSS0401	FCD0342			
RM 50	50	1978 → 1982	FSS0401	FCD0303			
TS 50	50	1979 →	FSS0401	FCD0303			
TS 50	50	1980 → 1983	FSS0401	FCD0303			
TS 50	50	1984 → 2002	FSS0401	FCD0342			
ZR 50 KEN - KEX	50	1979 → 1983	FSS0401	FCD0303			
ZR 50 SLK	50	1981 →	FSS0401	FCD0303			
ZR 50	50	1984 → 1987	FSS0401	FCD0303			
RM 60	60	2003 →	FSS0108	FCD0411		FCS0411/2	
RM 65	65	2003 → 2006	FSS0410	FCD0411		FCS0411/2	
DR Z 70	70	2008 → 2012		FCD0394			
DS 80	80	1980 → 2000	FSS0401	FCD0310			
FR 80 all models	80	1976 → 1983		FCD0374			
JR 80	80	2001 → 2007	FSS0401	FCD0310			
RM 80	80	1977 → 1979	FSS0401	FCD0301			
RM 80	80	1980 → 1981	FSS0202	FCD0301			
RM 80	80	1982 →	FSS0308	FCD0310			
RM 80	80	1983 →	FSS0307	FCD0310			
RM 80	80	1984 → 1985	FSS0307	FCD0301			
RM 80	80	1986 →	FSS0307	FCD1307			
RM 80	80	1987 → 1988	FSS0320	FCD0320			
RM 80	80	1989 →	FSS0308	FCD1312			
RM 80	80	1990 →	FSS0308	FCD1312			
RM 80	80	1991 → 2001		FCD1312			
RM 85	85	2002 → 2007		FCD1312			
RM 85	85	2008 →		FCD1312			
A 100 all models	100	1974 → 1980	FSS0303	FCD0354			
GP 100	100	1978 → 1987	FSS0303	FCD0302			
GP 100 N/UN	100	1979 →	FSS0303	FCD0301			
GP 100 N/UN	100	1980 → 1992	FSS0303	FCD0362			
RM 100	100	1976 →	FSS0303	FCD0302			
RM 100	100	1977 → 1978	FSS0303	FCD0304			
RM 100	100	1979 → 1981	FSS0303	FCD0302			
RM 100	100	2003 →		FCD0415		FCS0415/2	
TS 100	100	1973 → 1977	FSS0303	FCD0367			
TS 100	100	1978 → 1979	FSS0303	FCD0301			
TS 100	100	1979 →	FSS0303	FCD0301			
TS 100	100	1980 → 1981	FSS0303	FCD0365			
TS 100	100	1982 →	FSS0303	FCD0301			
DR Z 110	110	2003 → 2005	FSS0410	FCD0473			
SMASH 110	110	2003 →	FSS0404	FCD0473			
DF 125	125	→	FSS0307	FCD0301			
DR 125 S	125	1982 → 2001	FSS0307	FCD0301			
DR Z 125 K	125	2003 → 2012	FSS0307	FCD0301			
DR Z 125 L	125	2003 → 2012	FSS0307	FCD0301			
DR 125 SM	125	2008 → 2012	FSS0307	FCD0365			
FX 125	125	→	FSS0307	FCD0301			

RIEJU

20032

FERODO
RACING
Updated on November 2020

FCDXXXX
FCDXXXX/1
FCSXXXX/2
FCSXXXX/3

STANDARD
HIGH PERFORMANCE
STANDARD
HIGH PERFORMANCE

FRICITION PLATES ONLY
FRICITION PLATES ONLY
FRICITION PLATES + STEEL PLATES
FRICITION PLATES + STEEL PLATES

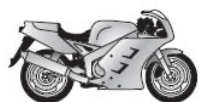

KIT RANGE

STANDARD
HIGH PERFORMANCESTANDARD
HIGH PERFORMANCE

...SUZUKI

GN 125	125	1982 → 1990	FSS0307	FCD0301				
GN 125	125	1994 → 2001	FSS0307	FCD0301				
GN 125 HS	125	2000 → 2011	FSS0307	FCD0301				
GP 125	125	1978 → 1979	FSS0303	FCD0302				
GP 125	125	1981 → 1984	FSS0303	FCD0359				
GS 125	125	1982 → 2000	FSS0307	FCD0301				
GT 125	125	1974 → 1977	FSS0303	FCD0301				
GT 125	125	1978 →	FSS0303	FCD0301				
GT 125	125	1979 →	FSS0303	FCD0365				
GZ 125 MARAUDER	125	1998 → 2011	FSS0307	FCD0301				
RG 125 W GAMMA	125	1986 → 1990	FSS0303	FCD0302				
RG 125 T - FV	125	1992 → 1994		FCD0302				
RG 125 UN WOLF (NAKED)	125	1992 → 1994		FCD0302				
RM 125	125	1976 → 1978	FSS0303	FCD0304				
RM 125	125	1979 →	FSS0303	FCD0302				
RM 125	125	1980 →	FSS0303	FCD0302				
RM 125	125	1981 → 1982	FSS0308	FCD0304				
RM 125	125	1983 → 1984	FSS0307	FCD0304				
RM 125	125	1985 →	FSS0307	FCD0304				
RM 125	125	1986 →		FCD1313				
RM 125	125	1987 →		FCD1313				
RM 125	125	1988 → 1990	FSS0310	FCD1311				
RM 125	125	1991 →	FSS0310	FCD1311				
RM 125	125	1992 →	FSS0306	FCD0334	FCD0334/1	FCS0334/2	FCS0334/3	
RM 125	125	1993 → 1995		FCD0334	FCD0334/1	FCS0334/2	FCS0334/3	
RM 125	125	1996 →		FCD0334	FCD0334/1	FCS0334/2	FCS0334/3	
RM 125	125	1997 → 2000	FSS0215	FCD0334	FCD0334/1	FCS0334/2	FCS0334/3	
RM 125	125	2001 →	FSS0215	FCD0334	FCD0334/1	FCS0334/2	FCS0334/3	
RM 125	125	2002 → 2012		FCD0454	FCD0454/1		FCS0454/3	
RV 125 VAN VAN	125	2002 → 2012	FSS0307	FCD0301				
T 125 STINGER	125	1969 → 1971	FSS0303	FCD0353				
TF 125 FARM BIKE	125	1978 → 2005	FSS0303	FCD0301				
TS 125	125	1973 → 1978	FSS0303	FCD0301				
TS 125 ERN (From F No 302346)	125	1979 →	FSS0303	FCD0365				
TS 125 ERN (Up to F No 302345)	125	1979 →	FSS0303	FCD0301				
TS 125	125	1980 → 1982	FSS0303	FCD0365				
TS 125 ERZ - FFS	125	1982 →	FSS0303	FCD0301				
TS 125	125	1983 → 1988	FSS0303	FCD0302				
TS 125 N from Frame No.178872	125	1984 →	FSS0303	FCD0365				
TS 125 N to Frame No.178871	125	1984 →	FSS0303	FCD0301				
TS 125	125	1989 →	FSS0303	FCD0302				
TS 125	125	1990 → 1996		FCD0302				
VL 125 INTRUDER	125	2000 → 2008	FSS0301	FCD0360				
PE 175	175	1978 → 1981	FSS0303	FCD0304				
PE 175	175	1982 →	FSS0303	FCD0304				
GT 185	185	1974 → 1979	FSS0303	FCD0302				
TS 185	185	1973 →	FSS0303	FCD0302				
TS 185	185	1974 → 1981	FSS0303	FCD0302				
DF 200 EV/EW/EY (SH42A)	200	1998 → 2000	FSS0307	FCD0301				
DR 200	200	1986 → 1989	FSS0401	FCD0302				
DR 200 DJEBEL	200	1993 → 2000		FCD1313				
DR 200	200	2001 → 2013		FCD1313				
GT 200	200	1979 → 1982	FSS0303	FCD0302				
RV 200 K2/K3	200	2002 → 2003	FSS0307	FCD0301				
SB 200	200	1979 → 1980	FSS0303	FCD0302				
SX 200	200	1990 → 1991	FSS0307	FCD0302				
TS 200 R	200	1990 →	FSS0307	FCD0304				
DR 250 S	250	1990 → 1995	FSS0307	FCD0332				
DR 250 R	250	1995 → 2000	FSS0207	FCD0125	FCD0125/1			
DR 250 R DJEBEL	250	1996 → 1998	FSS0207	FCD0125	FCD0125/1			
DR Z 250	250	2001 → 2007	FSS0207	FCD0125	FCD0125/1			
GN 250	250	1985 → 1997	FSS0301	FCD0316				
GS 250 E	250	1980 → 1981	FSS0308	FCD0304				
GSF 250 BANDIT (GJ74A)	250	1992 → 1996	FSS0308	FCD0302				
GSX 250	250	1980 → 1982	FSS0308	FCD0304				
GSX 250	250	1987 →	FSS0308	FCD0302				
GSX 250 S KATANA	250	1991 →	FSS0308	FCD0362				
GSX 250 (ZR 250C)	250	2000 → 2005	FSS0403	FCD0441				
GSX-R 250	250	1987 → 1989	FSS0308	FCD0302				
GSX-R 250 R	250	1989 →	FSS0308	FCD0362				
GT 250 K - L - M	250	1973 → 1974	FSS0301	FCD0381				
GT 250 K - L - M	250	1975 → 1978	FSS0301	FCD0351				
GT 250 EN - ET - EX	250	1979 → 1981	FSS0301	FCD0351				
GZ 250 MARAUDER	250	1999 → 2008	FSS0312	FCD0316				
LX 250 L (SBK2)	250	→	FSS0401	FCD0477				
PE 250 B - C	250	1977 → 1978	FSS0301	FCD0346				

FCDXXXX STANDARD FRICTION PLATES ONLY
FCDXXXX/1 HIGH PERFORMANCE FRICTION PLATES ONLY
FCSXXXX/2 STANDARD FRICTION PLATES + STEEL PLATES
FCSXXXX/3 HIGH PERFORMANCE FRICTION PLATES + STEEL PLATES

FERODO
RACING
Updated on November 2020

20033

KIT RANGE

 STANDARD
HIGH PERFORMANCE

 STANDARD
HIGH PERFORMANCE

...SUZUKI

PE 250 N	250	1979	→	FSS0301	FCD0346		
PE 250 T	250	1980	→	FSS0301	FCD0306		
PE 250 X - Z	250	1981	→ 1982	FSS0301	FCD0306		
RG 250 W GAMMA	250	1983	→	FSS0301	FCD0349	FCD0349/1	
RG 250 W GAMMA	250	1984	→	FSS0301	FCD0352		
RG 250 F GAMMA	250	1985	→ 1988	FSS0301	FCD0352		
RGV 250	250	1988	→	FSS0403	FCD0352		
RGV 250 K	250	1989	→ 1990	FSS0403	FCD0352		
RGV 250 GAMMA	250	1991	→ 1992	FSS0403	FCD0308	FCD0308/1	FCS0308/3
RGV 250	250	1993	→ 1995	FSS0403	FCD0308	FCD0308/1	FCS0308/3
RL 250	250	1974	→ 1975		FCD0351		
RL 250	250	1978	→ 1982	FSS0301	FCD0372		
RM 250	250	1976	→ 1978	FSS0301	FCD0346		
RM 250	250	1979	→ 1984	FSS0301	FCD0306		
RM 250	250	1985	→	FSS0301	FCD0306		
RM 250	250	1986	→	FSS0307	FCD1306		
RM 250	250	1987	→	FSS0320	FCD0321		FCS0321/3
RM 250	250	1988	→	FSS0305	FCD0322		FCS0322/3
RM 250	250	1989	→ 1990	FSS0305	FCD0322		FCS0322/3
RM 250	250	1991	→	FSS0309	FCD0322		FCS0322/3
RM 250	250	1992	→ 1993	FSS0306	FCD0333		
RM 250	250	1994	→ 1995	FSS0306	FCD0322		FCS0322/3
RM 250	250	1996	→	FSS0306	FCD0480	FCS0480/2	FCS0480/3
RM 250	250	1997	→ 2002	FSS0215	FCD0480	FCS0480/2	FCS0480/3
RM 250	250	2003	→ 2005	FSS0215	FCD0392		
RM 250	250	2006	→ 2012		FCD0391	FCS0391/2	
RMX 250	250	1989	→ 1990	FSS0305	FCD0322		FCS0322/3
RMX 250	250	1991	→	FSS0309	FCD0322		FCS0322/3
RMX 250	250	1992	→ 1993	FSS0306	FCD0333		
RMX 250	250	1994	→ 1999	FSS0306	FCD0322		FCS0322/3
RMZ 250	250	2004	→ 2006	FSS0417	FCD0378	FCD0378/1	FCS0378/2
RMZ 250	250	2007	→ 2009		FCD0378	FCD0378/1	FCS0378/2
RMZ 250	250	2010	→ 2015		FCD0378	FCD0378/1	FCS0378/2
SW1 250	250	1992	→	FSS0301	FCD0316		
T 250 SUPER SIX	250	1966	→ 1968		FCD0380		
T 250	250	1970	→ 1972	FSS0301	FCD0381		
TS 250 all models	250	1974	→ 1982	FSS0301	FCD0351		
TS 250 X all models	250	1985	→ 1989	FSS0307	FCD0302		
TU 250 S VOLTY	250	1992	→ 1997	FSS0301	FCD0316		
TU 250 X VOLTY	250	1997	→ 1998	FSS0301	FCD0316		
TU 250 X VOLTY	250	1999	→ 2000	FSS0312	FCD0316		
TU 250 GRASS TRACKER - BIG BOY	250	2000	→ 2001	FSS0312	FCD0316		
TV 250 WOLF	250	1988	→ 1990	FSS0403	FCD0352		
VL 250 INTRUDER	250	2000	→ 2007	FSS0312	FCD0316		
RL 325	325	1978	→ 1982	FSS0301	FCD0372		
DR 350	350	1990	→ 1999	FSS0307	FCD0332		
SG 350 GOOSE	350	1992	→	FSS0307	FCD0332		
T 350 all models	350	1969	→ 1972	FSS0301	FCD0381		
SP 370 C - N	370	1978	→ 1979	FSS0301	FCD0346		
GT 380 A - B - K	380	1973	→ 1977	FSS0301	FCD0351		
DR 400 ST - SX	400	1979	→ 1981	FSS0301	FCD0307		
DR Z 400 S	400	2000	→ 2008	FSS0318	FCD0363	FCD0363/1	FCS0363/2
DR Z 400 E	400	2000	→ 2009	FSS0318	FCD0363	FCD0363/1	FCS0363/2
DR Z 400 SM	400	2005	→ 2009	FSS0318	FCD0363	FCD0363/1	FCS0363/2
GN 400 TT	400	1980	→	FSS0301	FCD0307		
GS 400	400	1977	→ 1978	FSS0301	FCD0372		
GSF 400 S KATANA	400	1989	→ 1994	FSS0307	FCD0331		
GSF 400 BANDIT	400	1991	→ 1997	FSS0307	FCD0331		
GSR 400	400	2006	→	FSS0316	FCD1127	FCD1127/1	
GSX 400 R3 (GK71F)	400		→	FSS0307	FCD0370		
GSX 400 ET - EX - EZ	400	1980	→ 1982	FSS0301	FCD0308	FCD0308/1	FCS0308/3
GSX 400 FEX - FZ - FD	400	1981	→ 1983	FSS0301	FCD0307		
GSX 400 FWS - D - E - S	400	1983	→	FSS0301	FCD0307		
GSX 400 R2 (GK71B)	400	1985	→ 1986	FSS0307	FCD0370		
GSX 400 X IMPULSE	400	1986	→ 1988	FSS0307	FCD0370		
GSX 400 (GK74A)	400	1988	→ 1990	FSS0307	FCD0331		
GSX 400 KATANA	400	1992	→		FCD0384		
GSX 400 IMPULSE TYPE S	400	1994	→ 1996	FSS0301	FCD0123		
GSX 400	400	1997	→ 1999	FSS0301	FCD0123		
GSX 400 INAZUMA	400	2000	→	FSS0301	FCD0317		
GSX-R 400	400	1987	→	FSS0307	FCD0370		
GSX-R 400	400	1988	→ 1990	FSS0307	FCD0331		
GSX-R 400 R	400	1990	→ 1995	FSS0307	FCD0331		
PE 400 T	400	1980	→ 1981	FSS0301	FCD0307		
RF 400 RVC	400	1993	→ 1997	FSS0301	FCD0123		
RG 400 WALTER WOLF	400	1985	→ 1987	FSS0403	FCD1304	FCD1304/1	

SUZUKI
20034
FERODO
RACING

Updated on November 2020

FCDXXX
FCDXXX/1
FCSXXX/2
FCSXXX/3

 STANDARD
 HIGH PERFORMANCE
 STANDARD
 HIGH PERFORMANCE

 FRICTION PLATES ONLY
 FRICTION PLATES ONLY
 FRICTION PLATES + STEEL PLATES
 FRICTION PLATES + STEEL PLATES



KIT RANGE



STANDARD HIGH PERFORMANCE



STANDARD HIGH PERFORMANCE

...SUZUKI

					STANDARD	HIGH PERFORMANCE	STANDARD	HIGH PERFORMANCE
RM 400	400	1978 →	FSS0301	FCD0351				
RM 400	400	1979 →	FSS0301	FCD0307				
RM 400	400	1980 →	FSS0301	FCD0307				
SP 400	400	1980 →	FSS0301	FCD0307				
VS 400 INTRUDER	400	1994 →	FSS0304	FCD0323	FCD0323/1			
GS 425 EN	425	1978 →	FSS0301	FCD0372				
GS 450 E	450	1980 → 1988	FSS0301	FCD0308	FCD0308/1			FCS0308/3
RMX 450 EFI	450	2010 → 2012		FCD0389		FCS0389/2		
RMZ 450	450	2005 → 2007		FCD0389		FCS0389/2		
RMZ 450 EFI	450	2008 → 2015		FCD0389		FCS0389/2		
RM 465	465	1981 → 1982	FSS0301	FCD0313	FCD0313/1			
DR 500 SD - SE	500	1981 → 1983	FSS0304	FCD0317				
GS 500 E	500	1989 → 1995		FCD0308	FCD0308/1			FCS0308/3
GS 500	500	1996 → 2003		FCD0308	FCD0308/1			FCS0308/3
GS 500 F	500	2004 → 2008		FCD0308	FCD0308/1			FCS0308/3
GT 500	500	1976 → 1977	FSS0301	FCD0364				
RE 500	500	1975 → 1976	FSS0301	FCD0341				
RG 500 RF GAMMA	500	1985 → 1987		FCD1304	FCD1304/1			
RM 500	500	1983 → 1984	FSS0301	FCD0313	FCD0313/1			
T 500 all models	500	1968 → 1970	FSS0301	FCD0382				
T 500 all models	500	1971 → 1975	FSS0301	FCD0364				
GSX 550 ES - ESE	550	1984 → 1987	FSS0301	FCD0311				
GT 550 J	550	1972 →		FCD0371				
GT 550 K - L - M	550	1973 → 1975		FCD0371				
GT 550 A - B	550	1976 → 1977		FCD0371				
DR 600 R	600	1986 → 1989		FCD0317				
DR 600 S	600	1986 → 1988		FCD0317				
DR 600 R DAKAR-DJEBEL	600	1987 → 1988		FCD0317				
GSF 600 BANDIT	600	1995 → 2004	FSS0309	FCD1310				
GSR 600	600	2006 → 2008	FSS0316	FCD1127	FCD1127/1			
GSX 600 F KATANA	600	1992 → 1997	FSS0309	FCD0327				
GSX 600 F	600	1998 → 2006	FSS0309	FCD0315				
GSX-R 600	600	1996 → 2000		FCD1301		FCS1301/2		
GSX-R 600	600	2001 → 2005		FCD0399		FCS0399/2		
GSX-R 600	600	2006 → 2007	FSS0313	FCD0375	FCD0375/1	FCS0375/2		
GSX-R 600	600	2008 → 2010	FSS0313	FCD0377	FCD0377/1	FCS0377/2		
GSX-R 600	600	2011 → 2015		FCD0377	FCD0377/1	FCS0377/2		
RF 600 RR	600	1993 → 1996	FSS0309	FCD0336				
VS 600 GL INTRUDER	600	1995 → 1997		FCD0323	FCD0323/1			
DL 650 V STROM	650	2004 → 2006		FCD1302	FCD1302/1	FCS1302/2		
DL 650 V STROM X	650	2004 → 2012		FCD1302	FCD1302/1	FCS1302/2		
DR 650 R	650	1990 → 1993		FCD0335	FCD0335/1			
DR 650 RS-R DAKAR	650	1990 →		FCD0335	FCD0335/1			
DR 650 RS-RSE-DJEBEL-DAKAR	650	1991 → 1995		FCD0335	FCD0335/1			
DR 650 R	650	1994 → 1995		FCD1303				
DR 650 SE	650	1996 → 1997	FSS0101	FCD0326		FCS0326/2		
GS 650 GTX - GTZ - GX	650	1981 → 1983	FSS0301	FCD0305				
GS 650 GZ KATANA	650	1981 → 1982	FSS0301	FCD0305				
GS 650 TURBO	650	1983 →	FSS0301	FCD0305				
GSF 650 BANDIT	650	2005 → 2006		FCD0315				
GSF 650 BANDIT ABS	650	2005 → 2006		FCD0315				
GSF 650 BANDIT ABS	650	2007 → 2011		FCD1127	FCD1127/1			
GSF 650 S BANDIT ABS	650	2007 → 2011		FCD1127	FCD1127/1			
GSX 650 F	650	2008 → 2012		FCD1127	FCD1127/1			
LS 650 P SAVAGE	650	1987 → 1997		FCD0317				
SFV 650 GLADIUS	650	2009 → 2012		FCD1302	FCD1302/1	FCS1302/2		
SV 650	650	1999 → 2002	FSS0313	FCD1305				
SV 650	650	2003 → 2012		FCD1302	FCD1302/1	FCS1302/2		
SV 650 ABS	650	2003 → 2012		FCD1302	FCD1302/1	FCS1302/2		
XF 650 FREEWIND	650	1997 → 2002	FSS0101	FCD0326		FCS0326/2		
GS 700 E - ES	700	1985 →		FCD0305				
VS 700 GLE	700	1986 → 1987		FCD0323	FCD0323/1			
DR 750 S BIG	750	1987 → 1988		FCD1308				
DR 750 S BIG	750	1989 →		FCD1308				
GS 750	750	1977 → 1980	FSS0301	FCD0358				
GSX 750 S KATANA	750	1980 → 1986	FSS0301	FCD0305				
GSX 750 F	750	1989 → 1997	FSS0105	FCD0327				
GSX 750 F	750	1998 → 2006	FSS0309	FCD0315				
GSX-R 750	750	1988 → 1989	FSS0105	FCD0327				
GSX-R 750	750	1990 → 1992	FSS0309	FCD0327				
GSX-R 750 SP	750	1993 → 1995	FSS0309	FCD0327				
GSX-R 750 T SRAD	750	1996 → 1999		FCD1314		FCS1314/2		
GSX-R 750	750	2000 → 2001		FCD0398				
GSX-R 750	750	2002 → 2003		FCD0337	FCD0337/1			
GSX-R 750	750	2004 → 2005	FSS0316	FCD0337	FCD0337/1			
GSX-R 750	750	2006 → 2007	FSS0313	FCD1315	FCD1315/1	FCS1315/2	FCS1315/3	

FCDXXXX STANDARD FRICTION PLATES ONLY
 FCDXXXX/1 HIGH PERFORMANCE FRICTION PLATES ONLY
 FCSXXXX/2 STANDARD FRICTION PLATES + STEEL PLATES
 FCSXXXX/3 HIGH PERFORMANCE FRICTION PLATES + STEEL PLATES

FERODO
 RACING
 Updated on November 2020

20035



KIT RANGE



HIGH PERFORMANCE



HIGH PERFORMANCE

...SUZUKI

					STANDARD	HIGH PERFORMANCE	STANDARD	HIGH PERFORMANCE
GSX-R 750	750	2008 → 2010	FSS0313	FCD0377	FCD0377/1	FCS0377/2		
GSX-R 750	750	2011 → 2015		FCD0377	FCD0377/1	FCS0377/2		
GT 750	750	1972 → 1977		FCD0358				
VS 750 GL	750	1985 → 1991		FCD0323	FCD0323/1			
C 800 INTRUDER	800	2005 → 2012		FCD0323	FCD0323/1			
DR 800 Z	800	1988 → 1989		FCD1308				
DR 800 BIG S - SU	800	1990 →		FCD1308				
DR 800 BIG all models	800	1991 → 1993		FCD1308				
M 800 INTRUDER	800	2005 → 2012		FCD0323	FCD0323/1			
VL 800 INTRUDER LC VOLUSIA	800	2001 → 2004		FCD0323	FCD0323/1			
VS 800 INTRUDER	800	1992 → 1999		FCD0323	FCD0323/1			
VX 800	800	1990 → 1992		FCD0323	FCD0323/1			
VX 800	800	1993 → 1996		FCD0323	FCD0323/1			
VZ 800 MARAUDER	800	1997 → 2003		FCD0323	FCD0323/1			
GS 850	850	1979 → 1985	FSS0301	FCD0305				
RF 900 RR	900	1994 →		FCD0338				
RF 900 RR	900	1995 →	FSS0114	FCD0337	FCD0337/1			
RF 900 RT - RV	900	1996 → 1999	FSS0114	FCD0337	FCD0337/1			
DL 1000 V STROM	1000	2002 → 2010	FSS0118	FCD0385	FCD0385/1	FCS0385/2		
GS 1000 HC - SN	1000	1978 → 1979	FSS0301	FCD0312				
GS 1000 GT - GX	1000	1980 →	FSS0301	FCD0312				
GS 1000 ET	1000	1981 →	FSS0301	FCD0309	FCD0309/1			
GSX 1000 S KATANA	1000	1982 →	FSS0301	FCD0309	FCD0309/1			
GSX-R 1000	1000	2001 → 2003		FCD0467	FCD0467/1	FCS0467/2		
GSX-R 1000	1000	2004 →		FCD0467	FCD0467/1	FCS0467/2		
GSX-R 1000	1000	2005 → 2008		FCD0376	FCD0376/1	FCS0376/2		
GSX-R 1000	1000	2009 → 2015		FCD0379	FCD0379/1	FCS0379/2	FCS0379/3	
SV 1000 FAIRED	1000	2003 → 2007		FCD0385	FCD0385/1	FCS0385/2		
SV 1000 NAKED	1000	2003 → 2007		FCD0385	FCD0385/1	FCS0385/2		
TL 1000 S	1000	1997 → 1998	FSS0317	FCD0337	FCD0337/1			
TL 1000 R	1000	1998 → 2000		FCD0347				
TL 1000 S	1000	1999 → 2000		FCD0347				
TL 1000 S	1000	2001 → 2001		FCD0369				
GS 1100 GZ	1100	1982 →	FSS0301	FCD0309	FCD0309/1			
GSX 1100	1100	1980 → 1982	FSS0301	FCD0309	FCD0309/1			
GSX 1100 KATANA	1100	1983 →	FSS0301	FCD0355				
GSX 1100	1100	1984 → 1986	FSS0301	FCD0309	FCD0309/1			
GSX 1100 F	1100	1988 → 1992	FSS0105	FCD0324				
GSX 1100	1100	1991 → 1992		FCD0330				
GSX 1100 F	1100	1993 →		FCD0330				
GSX 1100	1100	1994 → 1995		FCD0330				
GSX-R 1100	1100	1986 → 1988	FSS0304	FCD0324				
GSX-R 1100	1100	1989 → 1992		FCD0330				
GSX-R 1100	1100	1993 → 1996		FCD0338				
GS 1200 SS K1	1200	2001 →		FCD1314		FCS1314/2		
GSF 1200 BANDIT	1200	1996 → 2005		FCD1314		FCS1314/2		
GSF 1200 S BANDIT	1200	1997 →		FCD1314		FCS1314/2		
GSF 1200 S BANDIT	1200	2001 → 2005		FCD1314		FCS1314/2		
GSF 1200 BANDIT	1200	2006 →		FCD1314		FCS1314/2		
GSF 1200 S BANDIT	1200	2006 →		FCD1314		FCS1314/2		
GSF 1200 BANDIT STREETFIGHTER	1200	2007 → 2012		FCD0395				
GSX 1200 X	1200	1999 → 2001		FCD1314		FCS1314/2		
GV 1200 GL MADURA	1200	1985 → 1986		FCD0366	FCD0366/1			
GSF 1250 BANDIT	1250	2007 → 2012		FCD0395				
GSF 1250 S BANDIT	1250	2007 → 2012		FCD0395				
GSX 1250 FA	1250	2010 → 2012		FCD0395				
GSX 1250 SPORT TOURING	1250	2010 → 2012		FCD0395				
GSX-R 1300 HAYABUSA	1300	1999 → 2001	FSS0315	FCD0340				
GSX-R 1300 HAYABUSA	1300	2002 → 2007	FSS0315	FCD0385	FCD0385/1	FCS0385/2		
GSX-R 1300 HAYABUSA	1300	2008 → 2012		FCD0385	FCD0385/1	FCS0385/2		
GSX-R 1300 HAYABUSA	1300	2013 →		FCD0385	FCD0385/1	FCS0385/2		
GSX 1340 B KING	1340	2008 → 2012		FCD0385	FCD0385/1	FCS0385/2		
GSX 1400	1400	2001 →		FCD0386				
GSX 1400	1400	2002 → 2007		FCD0383				
GV 1400	1400	1985 →		FCD0368				
GV 1400 CAVALCADE	1400	1986 → 1988		FCD0368				
GV 1400 GD	1400	1986 →		FCD0368				
VS 1400 INTRUDER	1400	1987 → 2003		FCD0325	FCD0325/1			
M 1500 INTRUDER	1500	2009 → 2012		FCD0395				
VL 1500 LC INTRUDER	1500	1998 → 2001	FSS0115	FCD0309	FCD0309/1			
VL 1500 INTRUDER	1500	2002 → 2003	FSS0115	FCD0309	FCD0309/1			
VL 1500 C INTRUDER	1500	2005 → 2009	FSS0115	FCD0309	FCD0309/1			
M 1600 INTRUDER	1600	2005 →		FCD0416				
VZ 1600 MARAUDER	1600	2004 →		FCD0416				
C 1800 R INTRUDER	1800	2008 → 2012	FSS0316	FCD0396				
C 1800 RT INTRUDER	1800	2008 → 2009	FSS0316	FCD0396				

20036

FERODO

RACING
Updated on November 2020

FCDXXX
FCDXXX/1
FCSXXX/2
FCSXXX/3

STANDARD
HIGH PERFORMANCE
STANDARD
HIGH PERFORMANCE

FRICITION PLATES ONLY
FRICITION PLATES ONLY
FRICITION PLATES + STEEL PLATES
FRICITION PLATES + STEEL PLATES



KIT RANGE



STANDARD HIGH PERFORMANCE



STANDARD HIGH PERFORMANCE

...SUZUKI

M 1800 R INTRUDER	1800	2006 → 2009		FCD0393		
M 1800 RZ INTRUDER	1800	2007 → 2012		FCD0393		
M 1800 R2 INTRUDER	1800	2008 → 2009		FCD0393		

SUZUKI ATV

LT 125	125	1984 →		FCD0303		
LT 125	125	1985 → 1987		FCD0303		
LT 160	160	1989 → 1992	FSS0120	FCD0318		
LT-F 160	160	1990 → 2003	FSS0120	FCD0318		
LT 160 QUADSPORT	160	2003 → 2004	FSS0120	FCD0318		
LT 185	185	1984 → 1985		FCD0303		
LT 230 GEF/GEG	230	1985 → 1986	FSS0120	FCD0318		
LT-F 230 G/H	230	1986 → 1987	FSS0120	FCD0318		
LT 250 EFF/EFG	250	1985 → 1986	FSS0120	FCD0328		
LT 250 R	250	1987 → 1990	FSS0307	FCD0321		FCS0321/3
LT-F 250 QUADRUNNER	250	1988 → 2001	FSS0120	FCD0328		
LT-F 250 4WD QUADRUNNER	250	1997 → 1998	FSS0120	FCD0328		
LT-F 250 F QUADRUNNER	250	1999 → 2002	FSS0120	FCD0328		
LT-F 250 K OZARK	250	2002 →	FSS0120	FCD0397		
LT-F 250 K OZARK	250	2004 →		FCD0388		
LT-Z 250 QUAD SPORT	250	2004 → 2012	FSS0120	FCD0388		
LT-F 250 K OZARK	250	2005 → 2012		FCD0328		
LT-F 300	300	1988 → 1989	FSS0120	FCD0328		
LT-F 300 QUADRUNNER 4WD	300	1991 → 1998	FSS0120	FCD1311		
LT-F 300 F KING QUAD	300	1999 → 2001	FSS0120	FCD1311		
LT-A 400 EIGER	400	2002 → 2007		FCD0412		
LT-F 400 EIGER	400	2002 →		FCD0412		
LT-F 400 EIGER 2WD	400	2003 → 2007		FCD0412		
LT-Z 400	400	2003 → 2004	FSS0318	FCD0363	FCD0363/1	FCS0363/2
LT-Z 400 QUAD SPORT	400	2005 → 2015	FSS0318	FCD0387		FCS0387/2
LT-A 400 KING QUAD 4WD	400	2008 → 2012		FCD0412		
LT-R 450	450	2006 → 2012		FCD0389		FCS0389/2
LT 500 R	500	1990 → 1991	FSS0307	FCD0322		FCS0322/3
LT-F 500 F QUADRUNNER	500	1998 → 2000	FSS0403	FCD0412		
LT-F 500 VISION QUADRUNNER	500	2003 → 2007	FSS0403	FCD0390		

TM

all models 80	80	1986 → 1993		FCD0642		
GS 80	80	1986 → 1989		FCD0642		
JUNIOR 80	80	1996 → 2000		FCD0642		
all models 125	125	1986 → 1993		FCD0642		
GS 125	125	1986 → 1989		FCD0642		
MC 125	125	1986 → 1989		FCD0642		
CROSS - ENDURO 125	125	1989 → 1990		FCD0642		

TRIUMPH

BABY SPEED 600	600	2001 → 2002		FCD0133	FCD0133/1	FCS0133/2
DAYTONA 600	600	2003 → 2005		FCD0133	FCD0133/1	FCS0133/2
SPEED FOUR 600	600	2003 → 2006		FCD0133	FCD0133/1	FCS0133/2
TT 600	600	2000 → 2003		FCD0133	FCD0133/1	FCS0133/2
DAYTONA 650	650	2005 →		FCD0125	FCD0125/1	
DAYTONA 675 up to VIN 381274	675	2006 → 2008		FCD0133	FCD0133/1	FCS0133/2
DAYTONA TRIPLE 675 VIN 381275 to VIN 564947	675	2009 → 2011		FCD0133	FCD0133/1	FCS0133/2
DAYTONA TRIPLE R 675 VIN 381275 to VIN 564947	675	2011 →		FCD0133	FCD0133/1	FCS0133/2
STREET TRIPLE 675 up to VIN 560476	675	2008 → 2012		FCD0133	FCD0133/1	FCS0133/2
STREET TRIPLE R 675 up to VIN 560476	675	2009 → 2012		FCD0133	FCD0133/1	FCS0133/2
STREET TRIPLE 675 from VIN 560477	675	2013 → 2015		FCD0133	FCD0133/1	FCS0133/2
STREET TRIPLE R 675 from VIN 560477	675	2013 → 2015		FCD0133	FCD0133/1	FCS0133/2
STREET TRIPLE RX 675	675	2015 →		FCD0133	FCD0133/1	FCS0133/2
(TRIDENT) SPRINT 749 749 Up to 9082	749	1993 →		FCD0736		
TRIDENT 749	749	1991 → 1998		FCD0736		
DAYTONA 750	750	1991 → 1992		FCD0736		
BONNEVILLE 790 (carb) Up to Eng No 282963-F2 / 273654-F4	790	2001 → 2006		FCD0732		
BONNEVILLE 790 AMERICA (carb)	790	2002 → 2004		FCD0733		
BONNEVILLE 790 (carb) T100 up to Eng No 211132	790	2002 → 2004		FCD0732		
SPEEDMASTER 790 (carb)	790	2003 → 2004		FCD0733		
TIGER 800	800	2011 → 2013		FCD0133	FCD0133/1	FCS0133/2
TIGER 800 ABS	800	2011 → 2014		FCD0133	FCD0133/1	FCS0133/2
TIGER XC 800	800	2011 → 2013		FCD0133	FCD0133/1	FCS0133/2
TIGER XC 800 ABS	800	2011 → 2014		FCD0133	FCD0133/1	FCS0133/2
TIGER XC 800	800	2015 →		FCD0133	FCD0133/1	FCS0133/2
TIGER XC X 800	800	2015 →		FCD0133	FCD0133/1	FCS0133/2

FCDXXXX STANDARD FRICTION PLATES ONLY
 FCDXXXX/1 HIGH PERFORMANCE FRICTION PLATES ONLY
 FCSXXXX/2 STANDARD FRICTION PLATES + STEEL PLATES
 FCSXXXX/3 HIGH PERFORMANCE FRICTION PLATES + STEEL PLATES



20037

TRIUMPH

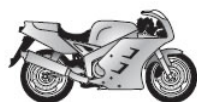

KIT RANGE



STANDARD
HIGH PERFORMANCE



STANDARD
HIGH PERFORMANCE

...TRIUMPH

				FCD0133	FCD0133/1	FCS0133/2	
TIGER XR 800	800	2015	→	FCD0133	FCD0133/1	FCS0133/2	
TIGER XR X 800	800	2015	→	FCD0133	FCD0133/1	FCS0133/2	
AMERICA 865 (carb)	865	2005	→ 2011	FCD0733			
AMERICA 865 EFI	865	2012	→ 2015	FCD0733			
BONNEVILLE 865 (carb) T100 Eng No 211133 up	865	2005	→ 2011	FCD0733			
BONNEVILLE 865 Eng No 282964-F2 / 273655-F4 up	865	2007	→ 2008	FCD0733			
BONNEVILLE 865 EFI (ALLOY WHEELS) VIN 380777 up	865	2009	→ 2015	FCD0733			
BONNEVILLE SE 865 EFI (ALLOY WHEELS) VIN 380777 up	865	2009	→ 2012	FCD0733			
BONNEVILLE 865 EFI T100	865	2012	→ 2015	FCD0733			
SCRAMBLER 865 (carb)	865	2006	→ 2011	FCD0733			
SCRAMBLER 865 EFI	865	2012	→ 2015	FCD0733			
SPEEDMASTER 865 (carb)	865	2005	→ 2010	FCD0733			
SPEEDMASTER 865 EFI	865	2011	→ 2015	FCD0733			
THRUXTON 865 (carb)	865	2004	→ 2011	FCD0733			
THRUXTON 865 EFI	865	2012	→ 2015	FCD0733			
ADVENTURER 885	885	1996	→ 2001	FCD0736			
LEGEND TT 885	885	1999	→ 2001	FCD0736			
SPEED TRIPLE 885 (carb)	885	1994	→ 1996	FCD0736			
SPEED TRIPLE 885 EFI T509 up to 141871	885	1997	→ 1998	FCD0122	FCD0122/1		
THUNDERBIRD 885	885	1995	→ 2003	FCD0736			
THUNDERBIRD SPORT 885	885	1996	→ 2000	FCD0736			
THUNDERBIRD SPORT 885	885	2003	→ 2004	FCD0736			
TIGER 885 up to VIN 71698	885	1993	→ 1998	FCD0736			
TIGER 885 VIN 71699 to VIN 124105	885	1999	→ 2000	FCD0122	FCD0122/1		
DAYTONA 900 (T300B)	900	1993	→ 1996	FCD0736			
DAYTONA 900 SUPER 3	900	1994	→ 1996	FCD0736			
SPRINT 900	900	1994	→ 1997	FCD0736			
SPRINT SPORTS 900	900	1997	→ 1998	FCD0736			
SPRINT EXECUTIVE 900	900	1998	→	FCD0736			
TRIDENT 900	900	1991	→ 1998	FCD0736			
TROPHY 900	900	1991	→ 2001	FCD0736			
DAYTONA 955 T595	955	1997	→ 2000	FCD0122	FCD0122/1		
DAYTONA 955i BI-BRACCIO	955	2001	→ 2002	FCD0735			
DAYTONA 955i CENTENNIAL	955	2002	→ 2002	FCD0735			
DAYTONA 955i	955	2003	→ 2006	FCD0735			
SPEED TRIPLE 955 T595 up to 141871	955	1999	→ 2001	FCD0122	FCD0122/1		
SPEED TRIPLE 955i VIN 141872 to 210444	955	2002	→ 2004	FCD0735			
SPRINT ST 955 up to VIN 139276	955	1999	→ 2001	FCD0122	FCD0122/1		
SPRINT RS 955 up to VIN 139276	955	2000	→ 2001	FCD0122	FCD0122/1		
SPRINT RS 955 FROM VIN 139277	955	2002	→ 2003	FCD0735			
SPRINT ST 955 VIN 139277 TO VIN 208166	955	2002	→ 2004	FCD0735			
TIGER 955 VIN 124106 to VIN 198874	955	1999	→ 2003	FCD0122	FCD0122/1		
TIGER 955 VIN 198875 to VIN 287503	955	2004	→ 2006	FCD0735			
DAYTONA 1000	1000	1991	→ 1992	FCD0736			
SPEED TRIPLE 1050 VIN 210445 to VIN 267599	1050	2005	→ 2007	FCD0735			
SPEED TRIPLE 1050 VIN 267599 to VIN 333178	1050	2005	→ 2007	FCD0735			
SPEED TRIPLE 1050 VIN 333179 to VIN 461331	1050	2008	→ 2010	FCD0735			
DAYTONA 1200	1200	1993	→ 1997	FCD0736			
TROPHY 1200 (t300)	1200	1991	→ 2003	FCD0736			
ROCKET III 2300	2300	2004	→	FCD0734			
ROCKET III 2300 CLASSIC	2300	2007	→	FCD0734			
ROCKET III 2300 ROADSTER	2300	2010	→	FCD0734			
ROCKET III 2300 TOURING	2300	2013	→	FCD0734			

VERTEMATI

C 450 CROSS	450	2003	→	FCD0504	FCD0504/1		
E 450 ENDURO	450	2002	→	FCD0504	FCD0504/1		
SR 450 MOTARD	450	2003	→	FCD0504	FCD0504/1		
SR 450 MOTARD RACING	450	2003	→	FCD0504	FCD0504/1		
C 500 CROSS	500		→ 2002	FCD0504	FCD0504/1		
E 501 ENDURO	501	2003	→	FCD0504	FCD0504/1		
S 501 MOTARD	501	2002	→	FCD0504	FCD0504/1		
C 570 CROSS	570	2003	→	FCD0504	FCD0504/1		
E 570 ENDURO	570	2003	→	FCD0504	FCD0504/1		
SR 600 MOTARD RACING	600	2003	→	FCD0504	FCD0504/1		

YAMAHA

DT 50 M	50	1978	→ 1979	FCD0202			
DT 50 MX	50	1978	→ 1995	FCD0202			
DT 50 M	50	1980	→ 1986	FCD0201			
DT 50 R	50	1997	→ 2008	FCD0279			
DT 50 X SUPERMOTARD	50	2004	→ 2008	FCD0279			
FS 1 50 E	50	1974	→ 1975	FCD0201			
FS 1 50 E DX	50	1977	→ 1979	FCD0201			

TRIUMPH

20038



Updated on November 2020

FCDXXXX
FCDXXXX/1
FCSXXXX/2
FCSXXXX/3

STANDARD
HIGH PERFORMANCE
STANDARD
HIGH PERFORMANCE

FRICTION PLATES ONLY
FRICTION PLATES ONLY
FRICTION PLATES + STEEL PLATES
FRICTION PLATES + STEEL PLATES

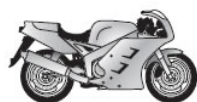

KIT RANGE



STANDARD HIGH PERFORMANCE



STANDARD HIGH PERFORMANCE

...YAMAHA

					STANDARD	HIGH PERFORMANCE	STANDARD	HIGH PERFORMANCE
FS 1 50 DX	50	1979 → 1980			FCD0201			
FS 1 50 SE	50	1981 → 1982			FCD0201			
FS 1 50	50	1987 → 1990			FCD0201			
RD 50 M	50	1978 →			FCD0202			
RD 50 M	50	1979 →			FCD0202			
RD 50 M	50	1980 →			FCD0201			
RD 50 MX	50	1981 → 1987			FCD0201			
RZ 50 (5FC1/2)	50	2002 →			FCD0207			
T 50 TOWNMATE	50	1986 →			FCD0270			
TY 50 M	50	1977 → 1978			FCD0202			
TY 50 M	50	1980 →			FCD0201			
TZR 50	50	1990 → 2002			FCD0284			
TZR 50	50	2003 →			FCD0284			
V 50 M - P	50	1974 → 1982			FCD0227			
YZ 50	50	1980 → 1983			FCD0202			
YZ 65	65	2018 → 2019			FCD1331	FCD1331/1	FCS1331/2	
DT 80 LC1 (37A)	80	1981 → 1984			FCD0207			
DT 80 MX Type 5J2	80	1981 → 1982			FCD0202			
DT 80 MX Type 12X	80	1983 →			FCD0202			
DT 80 MX Type 36N	80	1983 → 1985	FSS0401		FCD0207			
DT 80 MXS	80	1984 →			FCD0207			
DT 80 LC2 (53A)	80	1985 → 1992			FCD0211			
PW 80	80	1983 → 1991			FCD0227			
PW 80	80	1993 → 2006			FCD0227			
RD 80 AIR COOLED	80	1982 →			FCD0202			
RD 80 LC1	80	1982 →			FCD0207			
RD 80 LC2 - LCS	80	1982 →			FCD0207			
T 80 TOWNMATE	80	1983 → 1997			FCD0227			
TY 80	80	1977 →			FCD0202			
TY 80	80	1983 →			FCD0202			
V 80	80	1979 → 1982			FCD0227			
V 80 DL	80	1983 →			FCD0227			
YZ 80	80	1977 →			FCD0207			
YZ 80	80	1978 → 1979			FCD0211			
YZ 80	80	1980 →			FCD0207			
YZ 80	80	1981 → 1985			FCD1219			
YZ 80	80	1986 → 1989	FSS0206		FCD0228			
YZ 80	80	1993 → 1994	FSS0205		FCD0228			
YZ 80	80	1995 → 2001	FSS0206		FCD0246		FCS0246/2	
YZ 85	85	2002 → 2015	FSS0206		FCD1208	FCD1208/1		
T 90 N - D	90	2000 → 2008			FCD0262			
TT R 90	90	2000 → 2008			FCD0262			
AG 100 J	100	1982 →	FSS0401		FCD0277			
AG 100 E FARM BIKE	100	1993 →	FSS0401		FCD0277			
DT 100	100	1976 → 1980			FCD0254			
RS 100	100	1975 → 1976			FCD0277			
RS 100 DX	100	1977 → 1980			FCD0211			
RS 100	100	1977 → 1980			FCD0211			
RT 100	100	1994 → 2003	FSS0401		FCD0211			
RX S 100	100	1983 → 1997	FSS0401		FCD0211			
YB 100	100	1978 → 1992			FCD0256			
YZ 100	100	1978 → 1983	FSS0205		FCD0205			
CRYPTON 105 T	105	1996 → 1997	FSS0214		FCD0262			
CRYPTON 105 T	105	1998 →	FSS0214		FCD0262			
TT R 110 EX/EY	110	2008 → 2009			FCD1205			
V 110 SPORTY	110	1996 →	FSS0214		FCD0262			
RX 115	115	1999 →			FCD0211			
DT 125	125	1974 → 1975			FCD0281			
DT 125	125	1976 → 1977	FSS0205		FCD0254			
DT 125 E	125	1978 → 1979	FSS0401		FCD0254			
DT 125 MX	125	1980 → 1981			FCD0254			
DT 125 LC	125	1982 → 1983			FCD0268			
DT 125 LC	125	1985 →			FCD0258			
DT 125 LC	125	1986 → 1987			FCD0258			
DT 125 R	125	1988 → 2003	FSS0206		FCD0235			
DT 125 (3TT4)	125	1996 →			FCD0258			
DT 125 RE	125	2004 →	FSS0206		FCD0235			
DT 125 X SUPERMOTARD	125	2005 → 2006	FSS0206		FCD0235			
DT 125 RE	125	2005 → 2007	FSS0206		FCD0235			
IT 125 G - H - J	125	1980 → 1982			FCD0291			
RD 125 DX	125	1975 → 1976			FCD0254			
RD 125 DX	125	1978 → 1981			FCD0211			
RD 125 LC	125	1982 → 1987			FCD0258			
RS 125	125	1975 →			FCD0254			
RS 125 DX	125	1976 →			FCD0254			
RS 125 DX	125	1977 →			FCD0211			

FCDXXXX STANDARD FRICTION PLATES ONLY
 FCDXXXX/1 HIGH PERFORMANCE FRICTION PLATES ONLY
 FCSXXXX/2 STANDARD FRICTION PLATES + STEEL PLATES
 FCSXXXX/3 HIGH PERFORMANCE FRICTION PLATES + STEEL PLATES

FERODO
 RACING
 Updated on November 2020

20039

YAMAHA



KIT RANGE



HIGH PERFORMANCE



HIGH PERFORMANCE

...YAMAHA

				STANDARD	HIGH PERFORMANCE	STANDARD	HIGH PERFORMANCE
RZ 125 (1GV 030101-)	125	1985	→	FCD0258			
SR 125	125	1982	→ 1991	FCD0257			
SR 125 SE	125	1992	→ 1996	FCD0257			
SR 125	125	1997	→ 2002	FCD0257			
SR 125	125	2003	→	FCD0257			
TDR 125 (Italia)	125	1989	→ 1993	FCD1221			
TDR 125	125	1993	→ 2003	FSS0206	FCD0235		
TDR 125 R LIGHTBURNER	125	1993	→ 1994	FCD1221			
TTR 125	125	2000	→ 2009	FCD1210			
TTR 125 LW	125	2000	→ 2013	FCD1210			
TW 125	125	1999	→ 2002	FCD0205			
TW 125 R - S	125	2003	→ 2004	FCD0205			
TY 125	125	1980	→ 1982	FCD0205			
TZR 125	125	1987	→ 1992	FCD1217			
TZR 125 R	125	1991	→ 1995	FCD1221			
TZR 125 RED ROCKET	125	1993	→ 1995	FSS0206	FCD0235		
TZR 125	125	1993	→ 1995	FCD1221			
WR 125 R	125	2009	→ 2012	FSS0112	FCD0292		
WR 125 X SUPERMOTO	125	2009	→ 2013	FSS0112	FCD0292		
XT 125	125	1982	→ 1983	FCD0257			
XT 125 R	125	2005	→ 2006	FCD0211			
XT 125 X SUPERMOTARD	125	2005	→ 2006	FCD0211			
XT 125 R	125	2007	→ 2011	FCD0110	FCD0110/1		
XT 125 R (13D1)	125	2007	→	FCD0211			
XT 125 X SUPERMOTARD	125	2007	→ 2011	FCD0110	FCD0110/1		
XT 125 X SUPERMOTARD (13D2)	125	2007	→	FCD0211			
XTZ 125	125	2003	→ 2010	FCD0211			
XV 125 VIRAGO	125	1997	→ 2000	FSS0201	FCD0237	FCD0237/1	
XVS 125 DRAGSTAR	125	2000	→ 2004	FSS0201	FCD0237	FCD0237/1	
YBR 125 E (Brasil)	125	2000	→ 2008	FCD0211			
YBR 125 ED	125	2005	→ 2006	FCD0110	FCD0110/1		
YBR 125 CUSTOM	125	2006	→ 2012	FCD0110	FCD0110/1		
YBR 125 ED (Brasil)	125	2006	→ 2008	FCD0211			
YBR 125 ED	125	2007	→ 2012	FCD0110	FCD0110/1		
YZ 125	125	1976	→ 1977	FSS0205	FCD0205		
YZ 125	125	1977	→ 1981	FSS0205	FCD0206		
YZ 125	125	1982	→ 1983	FSS0205	FCD0266		
YZ 125	125	1983	→ 1984	FSS0205	FCD1216		
YZ 125	125	1985	→ 1986	FSS0205	FCD1216		
YZ 125	125	1986	→ 1987		FCD0216		
YZ 125	125	1987	→ 1988		FCD0216		
YZ 125	125	1988	→ 1989	FSS0201	FCD0234		
YZ 125	125	1989	→ 1990	FSS0201	FCD0233	FCS0233/2	
YZ 125	125	1991	→ 1992		FCD0240		FCS0240/3
YZ 125	125	1993	→ 2007		FCD0243	FCD0243/1	FCS0243/2
YZ 125	125	2008	→ 2019		FCD0243	FCD0243/1	FCS0243/2
YZF-R 125	125	2008	→ 2013	FSS0112	FCD0292		FCS0243/3
CRYPTON 135 X	135	2006	→ 2013		FCD1233		
RX 135	135	1981	→		FCD0258		
TZR 150 R	150	2000	→		FCD1221		
DT 175	175	1974	→ 1975		FCD0254		
DT 175	175	1976	→ 1977	FSS0205	FCD0254		
DT 175	175	1978	→ 1983		FCD0210		
DT 175	175	1996	→		FCD0297		
IT 175	175	1980	→ 1982	FSS0205	FCD0206		
TY 175	175	1977	→ 1980		FCD0205		
AG 200 E	200	1993	→		FCD0292		
DT 200 R	200	1987	→		FCD1221		
DT 200 WR	200	1992	→ 1993		FCD1221		
IT 200	200	1984	→	FSS0401	FCD0206		
RD 200 DX	200	1975	→ 1981		FCD0281		
RS 200	200	1979	→ 1980		FCD0281		
SDR 200	200	1987	→ 1989	FSS0206	FCD0235		
TW 200	200	2001	→ 2002		FCD0205		
WR 200	200	1992	→ 1994	FSS0206	FCD0235		
ST 225 BRONCO	225	1997	→		FCD0242		
TW 225 (5VC1/2)	225	2003	→		FCD0205		
XT 225 SEROW	225	1985	→ 1992		FCD0242		
XT 225 SEROW	225	1993	→		FCD0242		
XT 225	225	1997	→ 2006		FCD0242		
DT 230 R LANZA	230	1997	→ 1998	FSS0206	FCD0235		
DT 250	250	1975	→ 1976	FSS0201	FCD0208		
DT 250 MX	250	1977	→ 1980	FSS0201	FCD0261		
FZR 250	250	1987	→	FSS0307	FCD0263		
FZR 250 R	250	1989	→	FSS0307	FCD0263		
FZX 250 ZEAL	250	1991	→ 1992	FSS0307	FCD0263		

YAMAHA

20040

FERODO
RACING
Updated on November 2020

FCDXXXX
FCDXXXX/1
FCSXXXX/2
FCSXXXX/3

STANDARD
HIGH PERFORMANCE
STANDARD
HIGH PERFORMANCE

FRICTION PLATES ONLY
FRICTION PLATES ONLY
FRICTION PLATES + STEEL PLATES
FRICTION PLATES + STEEL PLATES



KIT RANGE



HIGH PERFORMANCE



HIGH PERFORMANCE

...YAMAHA

					STANDARD	HIGH PERFORMANCE	STANDARD	HIGH PERFORMANCE
IT 250 G	250	1980 →	FSS0201	FCD0280				
IT 250 H - J - K	250	1981 → 1983	FSS0201	FCD0217				
IT 250 L	250	1984 →	FSS0201	FCD1214				
RD 250	250	1974 → 1975	FSS0205	FCD0208				
RD 250	250	1976 → 1979	FSS0201	FCD0208				
RD 250 LC	250	1980 →	FSS0201	FCD0208				
RD 250 LC	250	1981 → 1983	FSS0201	FCD0208				
RZ 250 (4L3)	250	→	FSS0201	FCD0208				
RZ 250 R (1AR/1XG)	250	→	FSS0201	FCD0208				
RZ 250 R (29L)	250	→	FSS0201	FCD0208				
RZ 250 RR (51L)	250	1990 →	FSS0201	FCD0208				
SR 250 SE	250	1980 → 1982	FSS0201	FCD0278				
SR 250 US CUSTOM	250	1980 → 1981	FSS0201	FCD0213				
SR 250	250	1993 → 1994	FSS0201	FCD0278				
SR 250 CLASSIC	250	1996 → 2000	FSS0201	FCD0278				
SRV 250 SOULFULTWIN RENAISSA	250	1992 → 1997		FCD0237	FCD0237/1			
SRX 250	250	→	FSS0208	FCD0278				
TDR 250	250	1988 →		FCD1209				
TT 250 R	250	1993 → 1999	FSS0208	FCD1203				
TT R 250	250	2000 →		FCD0240				FCS0240/3
TY 250 S - RS	250	1984 → 1990	FSS0212	FCD0222				
TY 250 R	250	1991 → 1992	FSS0212	FCD0222				
TY 250 Z	250	1993 → 1995	FSS0201	FCD1209				
TY 250 Z SCOTTISH	250	1996 →	FSS0201	FCD1209				
TZR 250	250	1987 → 1992		FCD1209				
TZR 250 (REVERSE CYLINDER)	250	1989 → 1990	FSS0211	FCD0275				
TZR 250 R - RS - SP	250	1989 → 1995	FSS0202	FCD1209				
WR 250 Z	250	1991 → 1993	FSS0211	FCD1229				
WR 250 Z	250	1994 → 1997	FSS0211	FCD1230				
WR 250	250	1998 → 1999	FSS0211	FCD0215	FCD0215/1	FCS0215/2	FCS0215/3	
WR 250	250	2000 → 2001	FSS0208	FCD0215	FCD0215/1	FCS0215/2	FCS0215/3	
WR 250	250	2002 →	FSS0213	FCD0215	FCD0215/1	FCS0215/2	FCS0215/3	
WR F 250	250	2001 → 2013		FCD0251	FCD0251/1	FCS0251/2	FCS0251/3	
WR R 250	250	2008 → 2013		FCD0240				FCS0240/3
WR X 250	250	2008 → 2013		FCD0240				FCS0240/3
XG 250 TRICKER	250	2004 → 2006	FSS0211	FCD1203				
XS 250 C	250	1978 →	FSS0201	FCD0217				
XS 250 D - E	250	1979 → 1981	FSS0201	FCD0217				
XS 250 SE - SF SPECIAL	250	1979 → 1981	FSS0208	FCD0280				
XS 250 C	250	1981 →	FSS0208	FCD0280				
XT 250	250	1980 →	FSS0401	FCD0213				
XT 250 X	250	2006 → 2008	FSS0211	FCD1203				
XT 250 LANDER (BRASIL)	250	2007 → 2009		FCD0162				
XV 250 VIRAGO	250	1989 → 1994	FSS0201	FCD0237	FCD0237/1			
XVS 250 VIRAGO	250	1995 → 2000	FSS0201	FCD0237	FCD0237/1			
XVS 250 DRAGSTAR	250	2001 → 2004	FSS0201	FCD0280				
YBR 250	250	2007 → 2011		FCD0162				
YS 250 Fazer (Brasil) (1S41/2/3)	250	2006 → 2008		FCD0162				
YZ 250	250	1977 → 1978	FSS0201	FCD0271				
YZ 250	250	1979 →	FSS0201	FCD0280				
YZ 250	250	1980 →	FSS0201	FCD0271				
YZ 250	250	1981 →	FSS0201	FCD0217				
YZ 250	250	1982 → 1984	FSS0201	FCD1214				
YZ 250	250	1985 →		FCD0218				FCS0218/3
YZ 250	250	1986 → 1987	FSS0201	FCD1214				
YZ 250	250	1988 → 1992	FSS0211	FCD0231	FCD0231/1		FCS0231/3	
YZ 250	250	1993 → 1999	FSS0211	FCD0215	FCD0215/1	FCS0215/2	FCS0215/3	
YZ 250	250	2000 → 2001	FSS0208	FCD0215	FCD0215/1	FCS0215/2	FCS0215/3	
YZ 250	250	2002 → 2012	FSS0213	FCD0215	FCD0215/1	FCS0215/2	FCS0215/3	
YZ 250	250	2015 →	FSS0213	FCD0215	FCD0215/1	FCS0215/2	FCS0215/3	
YZ-F 250	250	2001 → 2013		FCD0251	FCD0251/1	FCS0251/2	FCS0251/3	
YZ-F 250 EFI	250	2014 → 2018		FCD0251	FCD0251/1	FCS0251/2	FCS0251/3	
YZ-F 250 EFI	250	2019 →		FCD0378	FCD0378/1	FCS0378/2	FCS0378/3	
MT-03 320	320	2016 → 2019		FCD1326	FCD1326/1	FCS1326/2		
YZF R3 320	320	2015 → 2019		FCD1326	FCD1326/1	FCS1326/2		
RD 350 S	350	1974 → 1976	FSS0205	FCD0208				
RD 350 LC	350	1980 →	FSS0201	FCD0208				
RD 350 LC	350	1981 → 1982	FSS0201	FCD0208				
RD 350 YPVS	350	1983 → 1984	FSS0201	FCD0208				
RD 350 LC N-F all models	350	1985 → 1992	FSS0201	FCD0208				
RD 350 R	350	1992 → 1995	FSS0201	FCD0208				
TT 350	350	1985 → 1995		FCD1212				
XT 350	350	1985 → 1995		FCD1212				
DT 400	400	1975 → 1977	FSS0201	FCD0208				
FZ 400 N	400	1985 →	FSS0202	FCD1213	FCD1213/1			
FZ 400	400	1996 →	FSS0408	FCD1204				

FCDXXXX STANDARD FRICTION PLATES ONLY
FCDXXXX/1 HIGH PERFORMANCE FRICTION PLATES ONLY
FCSXXXX/2 STANDARD FRICTION PLATES + STEEL PLATES
FCSXXXX/3 HIGH PERFORMANCE FRICTION PLATES + STEEL PLATES

FERODO
RACING
 Updated on November 2020

20041



KIT RANGE



STANDARD HIGH PERFORMANCE



STANDARD HIGH PERFORMANCE

...YAMAHA

Model	Capacity	Year	Year Range	Part No.	Kit	Performance	Kit	Performance
FZR 400 GENESIS	400	1986	→			FCD0238/1		
FZR 400 RSP	400	1987	→		FCD0236			
FZR 400 R	400	1989	→			FCD0238/1		
FZR 400 RR	400	1991	→ 1992			FCD0238/1		
FZR 400 SP	400	1991	→		FCD0236			
RD 400 C - D	400	1976	→ 1977	FSS0201	FCD0208			
RD 400 E - F	400	1978	→ 1979	FSS0201	FCD0208			
SRX 400	400	1985	→ 1996	FSS0211	FCD1215	FCD1215/1		
WR F 400	400	1998	→ 2002	FSS0208	FCD0232		FCS0232/2	FCS0232/3
XJR 400	400	1993	→ 1999	FSS0211	FCD1213	FCD1213/1		
XS 400 C	400	1978	→	FSS0201	FCD0217			
XS 400	400	1979	→	FSS0201	FCD0217			
XS 400 SE	400	1980	→ 1981	FSS0201	FCD0217			
XS 400	400	1982	→	FSS0201	FCD0260			
XVS 400	400	1998	→ 1999	FSS0215	FCD0225	FCD0225/1		
YZ 400	400	1977	→ 1979	FSS0201	FCD0217			
YZ-F 400	400	1998	→ 1999	FSS0208	FCD1218			
YZ-F 400	400	1999	→	FSS0208	FCD1218			
IT 425 G	425	1980	→ 2000	FSS0201	FCD0217			
WR F 426	426	2000	→	FSS0412	FCD0249		FCS0249/2	FCS0249/3
WR F 426	426	2001	→ 2002	FSS0412	FCD0249		FCS0249/2	FCS0249/3
YZ-F 426	426	2000	→ 2001	FSS0208	FCD0248		FCS0248/2	FCS0248/3
YZ-F 426	426	2001	→ 2002	FSS0213	FCD0249		FCS0249/2	FCS0249/3
WR F 450	450	2003	→	FSS0412	FCD0249		FCS0249/2	FCS0249/3
WR F 450	450	2004	→	FSS0412	FCD1228			
WR F 450	450	2005	→ 2008	FSS0213	FCD0678	FCD0678/1		
WR F 450	450	2009	→ 2015	FSS0213	FCD0678	FCD0678/1		
YZ-F 450	450	2003	→ 2004	FSS0213	FCD0248		FCS0248/2	FCS0248/3
YZ-F 450	450	2005	→ 2006	FSS0210	FCD0248		FCS0248/2	FCS0248/3
YZ-F 450	450	2007	→ 2009	FSS0204	FCD0215	FCD0215/1	FCS0215/2	FCS0215/3
YZ-F 450	450	2010	→	FSS0204	FCD0215	FCD0215/1	FCS0215/2	FCS0215/3
YZ-F 450	450	2011	→ 2015	FSS0204	FCD1234		FCS1234/2	FCS1234/3
IT 465	465	1981	→ 1982	FSS0201	FCD0217			
YZ 465	465	1980	→	FSS0201	FCD0217			
YZ 465	465	1981	→	FSS0201	FCD0217			
IT 490	490	1984	→	FSS0201	FCD0218			FCS0218/3
YZ 490	490	1981	→ 1988	FSS0201	FCD0218			FCS0218/3
RD 500 LC	500	1984	→ 1986	FSS0202	FCD0283			
RZV 500 R (51X)	500	1985	→	FSS0202	FCD0283			
SR 500	500	1978	→ 1998	FSS0202	FCD0255			
T MAX 500 XP	500	2001	→ 2011	FSS0217	FCD0290	FCD0290/1	FCS0290/2	FCS0290/3
T MAX ABS 500 XP	500	2005	→ 2011	FSS0217	FCD0290	FCD0290/1	FCS0290/2	FCS0290/3
T MAX SV 500 XP	500	2011	→	FSS0217	FCD0290	FCD0290/1	FCS0290/2	FCS0290/3
T MAX SV ABS 500 XP	500	2011	→	FSS0217	FCD0290	FCD0290/1	FCS0290/2	FCS0290/3
TT 500	500	1980	→ 1981	FSS0202	FCD0255			
WR 500	500	1992	→ 1993	FSS0201	FCD1214			
XS 500 C	500	1976	→ 1979	FSS0202	FCD1213	FCD1213/1		
XT 500	500	1976	→	FSS0202	FCD0259			
XT 500	500	1977	→ 1981	FSS0202	FCD0255			
T MAX 530 XP	530	2012	→ 2017	FSS0220	FCD1232	FCD1232/1		FCS1232/3
XV 535 VIRAGO	535	1987	→ 2001	FSS0215	FCD0225	FCD0225/1		
XV 535 DX VIRAGO	535	2001	→ 2003	FSS0215	FCD0225	FCD0225/1		
XJ5 550 MAXIM	550	1981	→ 1984	FSS0202	FCD0229			
XJ5 550 SECA	550	1981	→ 1983	FSS0202	FCD0229			
XJ5 550	550	1981	→ 1984	FSS0202	FCD0229			
XT 550	550	1982	→	FSS0202	FCD1218			
XT 550	550	1983	→	FSS0202	FCD0223	FCD0223/1	FCS0223/2	
XZ 550	550	1982	→ 1984	FSS0202	FCD0255			
FZ 600	600	1987	→ 1988	FSS0202	FCD1213	FCD1213/1		
FZ6 600 FAZER	600	2004	→ 2007	FSS0203	FCD0212	FCD0212/1	FCS0212/2	FCS0212/3
FZ6 N 600	600	2004	→ 2007	FSS0203	FCD0212	FCD0212/1	FCS0212/2	FCS0212/3
FZ6 NS 600	600	2005	→ 2006	FSS0203	FCD0212	FCD0212/1	FCS0212/2	FCS0212/3
FZ6 600 FAZER ABS	600	2006	→ 2007	FSS0203	FCD0212	FCD0212/1	FCS0212/2	FCS0212/3
FZ6 S2 600 FAZER	600	2007	→ 2009	FSS0203	FCD0212	FCD0212/1	FCS0212/2	FCS0212/3
FZ6 S2 600	600	2007	→ 2009	FSS0203	FCD0212	FCD0212/1	FCS0212/2	FCS0212/3
FZ6 S2 600 FAZER ABS	600	2008	→	FSS0203	FCD0212	FCD0212/1	FCS0212/2	FCS0212/3
FZR 600	600	1989	→		FCD0236			
FZR 600	600	1990	→ 1995		FCD0236			
FZR 600 R	600	1994	→ 1995	FSS0211	FCD1224			
FZS 600 FAZER	600	1998	→ 1999	FSS0201	FCD0267		FCS0267/2	
FZS 600 SP FAZER	600	2000	→ 2003	FSS0211	FCD0267		FCS0267/2	
SRX 600	600	1985	→ 1991	FSS0202	FCD0223	FCD0223/1	FCS0223/2	
TT 600 L	600	1983	→ 1984	FSS0201	FCD1215	FCD1215/1		
TT 600 N	600	1985	→ 1988	FSS0201	FCD1215	FCD1215/1		
TT 600	600	1989	→ 1992	FSS0201	FCD1215	FCD1215/1		
TT 600 E	600	1993	→ 2001	FSS0201	FCD1215	FCD1215/1		

YAMAHA

20042

FERODO
RACING
Updated on November 2020

FCDXXX
FCDXXX/1
FCSXXX/2
FCSXXX/3

STANDARD
HIGH PERFORMANCE
STANDARD
HIGH PERFORMANCE

FRICITION PLATES ONLY
FRICITION PLATES ONLY
FRICITION PLATES + STEEL PLATES
FRICITION PLATES + STEEL PLATES



HIGH PERFORMANCE



HIGH PERFORMANCE

...YAMAHA

					STANDARD	HIGH PERFORMANCE	STANDARD	HIGH PERFORMANCE
TT 600 K	600	1993 → 1996	FSS0201	FCD1215	FCD1215	FCD1215/1		
TT 600 K (4GW)	600	1995 → 1996	FSS0201	FCD1215	FCD1215	FCD1215/1		
TT 600 R	600	1997 →	FSS0201	FCD1215	FCD1215	FCD1215/1		
TT R 600	600	1998 → 2002	FSS0201	FCD1215	FCD1215	FCD1215/1		
TT R 600 E	600	2004 →	FSS0201	FCD0255				
XJ S 600 DIVERSION	600	1992 → 2002	FSS0202	FCD1213	FCD1213	FCD1213/1		
XJ N 600	600	1995 → 2003	FSS0202	FCD1213	FCD1213	FCD1213/1		
XJ6 N 600	600	2009 → 2011	FSS0203	FCD0229				
XJ6 S 600 DIVERSION	600	2009 → 2011	FSS0203	FCD0229				
XJ6 F 600 DIVERSION	600	2010 → 2011	FSS0203	FCD0229				
XJ6 FA 600 DIVERSION	600	2011 →	FSS0203	FCD0229				
XT 600 4 VALVES	600	1984 → 1990		FCD0223	FCD0223/1	FCS0223/2		
XT E 600	600	1990 → 2002		FCD0223	FCD0223/1	FCS0223/2		
XT K 600	600	1991 → 1993		FCD0223	FCD0223/1	FCS0223/2		
XT Z 600 TENERE	600	1983 → 1984		FCD0223	FCD0223/1	FCS0223/2		
XT Z 600 TENERE	600	1985 → 1990		FCD0223	FCD0223/1	FCS0223/2		
YZ-F 600 R THUNDER CAT	600	1996 → 2004	FSS0211	FCD0245				
YZ-F 600 R6	600	1999 → 2002	FSS0203	FCD0212	FCD0212/1	FCS0212/2	FCS0212/3	
YZ-F 600 R6	600	2003 → 2004	FSS0213	FCD0212	FCD0212/1	FCS0212/2	FCS0212/3	
YZ-F 600 R6	600	2005 → 2005	FSS0213	FCD0212	FCD0212/1	FCS0212/2	FCS0212/3	
YZ-F 600 R6	600	2006 → 2015		FCD1222		FCS1222/2	FCS1222/3	
XJ 650	650	1980 → 1984	FSS0211	FCD1213	FCD1213/1			
XJ 650 MAXIM	650	1980 → 1983	FSS0211	FCD1213	FCD1213/1			
XJ 650 MIDNIGHT	650	1981 →	FSS0211	FCD1213	FCD1213/1			
XJ 650 SECA	650	1982 →	FSS0202	FCD1213	FCD1213/1			
XJ 650 TURBO	650	1983 →	FSS0202	FCD1213	FCD1213/1			
XJ 650 SECA	650	1983 →	FSS0202	FCD1213	FCD1213/1			
XS 650	650	1975 → 1976	FSS0202	FCD0203	FCD0203/1			
XS 650	650	1977 → 1979	FSS0201	FCD0203	FCD0203/1			
XS 650 SE	650	1979 → 1980	FSS0202	FCD0209				
XS 650	650	1980 → 1981	FSS0202	FCD0209				
XVS 650 DRAG STAR	650	1997 → 2004	FSS0215	FCD1229				
XVS 650 A DRAG STAR CLASSIC	650	1998 → 2007	FSS0215	FCD1229				
MT-03	660	2006 → 2012		FCD1201				
SZR 660	660	1996 → 1997		FCD0223	FCD0223/1	FCS0223/2		
XT R 660	660	2004 →		FCD1201				
XT X 660	660	2004 →		FCD1201				
XT Z 660 TENERE	660	1991 → 1996		FCD0223	FCD0223/1	FCS0223/2		
XT Z 660 TENERE	660	2008 → 2012		FCD1201				
MTT 690 A TRACER (700)	690	2016 →		FCD1329	FCD1329/1	FCS1329/2	FCS1329/3	
MT-07 700	700	2014 → 2016		FCD1329	FCD1329/1	FCS1329/2	FCS1329/3	
MT-07 700 MOTO CAGE	700	2014 → 2015		FCD1329	FCD1329/1	FCS1329/2	FCS1329/3	
MT-07 700 A	700	2017 →		FCD1329	FCD1329/1	FCS1329/2	FCS1329/3	
XSR 700	700	2016 → 2017		FCD1329	FCD1329/1	FCS1329/2	FCS1329/3	
FZ 750	750	1985 → 1986	FSS0203	FCD0212	FCD0212/1	FCS0212/2	FCS0212/3	
FZ 750 GENESIS	750	1987 → 1992	FSS0203	FCD0229				
FZR 750 GENESIS	750	1987 →	FSS0203	FCD0230				
FZR 750 (OW01)	750	1989 → 1991	FSS0203	FCD0239	FCD0239/1	FCS0239/2		
FZX 750	750	1988 →	FSS0203	FCD0229				
XJ 750 SECA	750	1981 → 1983	FSS0202	FCD1213	FCD1213/1			
XJ 750	750	1982 → 1984	FSS0202	FCD1213	FCD1213/1			
XS 750	750	1977 → 1979	FSS0202	FCD0217				
XS 750 SE	750	1979 → 1980	FSS0202	FCD0217				
XTZ 750 SUPER TENERE	750	1989 → 1995	FSS0203	FCD1213	FCD1213/1			
XV 750 SE	750	1981 →	FSS0211	FCD1230				
XV 750 VIRAGO	750	1992 → 1993	FSS0211	FCD1230				
YZ-F 750 RR-SP	750	1993 → 1998	FSS0203	FCD0239	FCD0239/1	FCS0239/2		
YZ-F 750 R7 (OW02) road version	750	1999 → 2000		FCD0286				
FZ8 N 800	800	2011 →		FCD0296				
FZ8 NA 800	800	2011 → 2012		FCD0296				
FZ8 S 800 FAZER	800	2011 →		FCD0296				
FZ8 SA 800 FAZER	800	2011 →		FCD0296				
MT-09 850	850	2014 → 2016		FCD1328	FCD1328/1	FCS1328/2	FCS1328/3	
MT-09 850 STREET RALLY	850	2014 →		FCD1328	FCD1328/1	FCS1328/2	FCS1328/3	
MT-09 850 SPORT TRACKER	850	2015 →		FCD1328	FCD1328/1	FCS1328/2	FCS1328/3	
MT-09 850 TRACER	850	2015 → 2016		FCD1328	FCD1328/1	FCS1328/2	FCS1328/3	
MT-09 850 (MTN 850-A)	850	2017 →		FCD1327	FCD1327/1			
MT-09 850 A TRACER	850	2017 →		FCD1327	FCD1327/1			
TDM 850	850	1991 → 1995	FSS0203	FCD1213	FCD1213/1			
TDM 850	850	1996 → 1998	FSS0203	FCD0239	FCD0239/1	FCS0239/2		
TDM 850	850	1999 → 2001	FSS0213	FCD1223				
TRX 850	850	1996 → 1997	FSS0203	FCD0239	FCD0239/1	FCS0239/2		
XS 850	850	1980 →	FSS0202	FCD0252				
TDM 900	900	2002 → 2012	FSS0204	FCD1223				
TDM 900 ABS	900	2005 → 2007	FSS0204	FCD1223				
XJ 900	900	1983 → 1990	FSS0208	FCD1213	FCD1213/1			

FCDXXXX STANDARD FRICTION PLATES ONLY
FCDXXXX/1 HIGH PERFORMANCE FRICTION PLATES ONLY
FCSXXXX/2 STANDARD FRICTION PLATES + STEEL PLATES
FCSXXXX/3 HIGH PERFORMANCE FRICTION PLATES + STEEL PLATES

FERODO
RACING
Updated on November 2020

20043



KIT RANGE



STANDARD
HIGH PERFORMANCE



STANDARD
HIGH PERFORMANCE

...YAMAHA

					STANDARD	HIGH PERFORMANCE	STANDARD	HIGH PERFORMANCE
XJ 900 F	900	1985 → 1992	FSS0203	FCD1213	FCD1213	FCD1213/1		
XJ S 900 DIVERSION	900	1995 → 2003	FSS0203	FCD1213	FCD1213	FCD1213/1		
XSR 900 (850)	900	2016 → 2017		FCD1327	FCD1327	FCD1327/1		
XVS 950 A MIDNIGHT STAR	950	2009 → 2011		FCD1206	FCD1206			
FZ1 1000	1000	2006 → 2012		FCD1226	FCD1226	FCD1226/1	FCS1226/2	FCS1226/3
FZ1 1000 FAZER	1000	2006 → 2012		FCD1226	FCD1226	FCD1226/1	FCS1226/2	FCS1226/3
FZ1 1000 FAZER ABS	1000	2007 → 2012		FCD1226	FCD1226	FCD1226/1	FCS1226/2	FCS1226/3
FZR 1000 GENESIS	1000	1986 → 1989	FSS0203	FCD0230	FCD0230			
FZR 1000 R - EX-UP	1000	1989 → 1990	FSS0204	FCD0241	FCD0241			
FZR 1000 EX-UP	1000	1991 → 1992	FSS0204	FCD0241	FCD0241			
FZR 1000 EX-UP	1000	1993 →	FSS0204	FCD0244	FCD0244			
FZR 1000 R	1000	1994 → 1995	FSS0204	FCD0244	FCD0244			
FZS 1000 FAZER	1000	2001 → 2005	FSS0204	FCD0285	FCD0285			
GTS 1000	1000	1993 → 1996	FSS0204	FCD0244	FCD0244			
MT-10 1000	1000	2016 → 2018		FCD1330	FCD1330	FCD1330/1		
XV 1000 TR 1	1000	1981 →	FSS0202	FCD1230	FCD1230			
XV 1000 VIRAGO	1000	1986 →	FSS0202	FCD1230	FCD1230			
YZ-F 1000 R THUNDER ACE	1000	1996 → 2001	FSS0204	FCD0244	FCD0244			
YZ-F 1000 R1	1000	1998 →		FCD1220	FCD1220	FCD1220/1	FCS1220/2	
YZ-F 1000 R1	1000	1999 → 2003		FCD0247	FCD0247	FCD0247/1	FCS0247/2	FCS0247/3
YZ-F 1000 R1	1000	2004 → 2006		FCD1226	FCD1226	FCD1226/1	FCS1226/2	FCS1226/3
YZ-F 1000 R1	1000	2007 → 2008		FCD1225	FCD1225		FCS1225/2	
YZ-F 1000 R1	1000	2009 → 2012		FCD1227	FCD1227		FCS1227/2	FCS1227/3
YZ-F 1000 R1 ABS	1000	2012 → 2014		FCD1227	FCD1227		FCS1227/2	FCS1227/3
YZ-F 1000 R1	1000	2015 → 2018		FCD1330	FCD1330	FCD1330/1		
YZ-F 1000 R1M	1000	2015 → 2018		FCD1330	FCD1330	FCD1330/1		
BT 1100 BULLDOG	1100	2002 → 2006		FCD1230	FCD1230			
FJ 1100 J	1100	1984 → 1985		FCD0219	FCD0219			
XS 1100	1100	1978 → 1980	FSS0202	FCD0204	FCD0204			
XS 1100 S	1100	1981 →	FSS0202	FCD0204	FCD0204			
XV 1100 VIRAGO	1100	1986 → 2000		FCD1230	FCD1230			
XVS 1100 DRAG STAR	1100	1999 → 2004		FCD1230	FCD1230			
XVS 1100 A DRAG STAR CLASSIC	1100	2000 → 2006		FCD1230	FCD1230			
FJ 1200	1200	1986 → 1991		FCD0219	FCD0219			
FJ 1200 ABS	1200	1991 → 1995		FCD0219	FCD0219			
V-MAX 1200 (YMX 12N)	1200	1991 → 2003		FCD0226	FCD0226	FCD0226/1		
XJR 1200	1200	1995 → 1997		FCD0219	FCD0219			
XTZ 1200 SUPER TENERE	1200	2010 → 2013		FCD0293	FCD0293			
XVZ 1200 12 TD	1200	1988 →		FCD0226	FCD0226	FCD0226/1		
FJR 1300 ABS	1300	2003 → 2012		FCD0293	FCD0293			
FJR 1300 A	1300	2013 →		FCD0293	FCD0293			
FJR 1300 AS	1300	2013 →		FCD0293	FCD0293			
XJR 1300	1300	1999 → 2011		FCD0219	FCD0219			
XJR 1300 SP	1300	2001 →		FCD0219	FCD0219			
XVS 1300 A MIDNIGHT STAR	1300	2007 → 2011		FCD0293	FCD0293			
XVZ 1300 TD	1300	1989 → 1990		FCD0226	FCD0226	FCD0226/1		
XVZ 1300 ROYAL STAR	1300	1996 → 2000		FCD0226	FCD0226	FCD0226/1		
XVZ 1300 TF ROYAL STAR VENTURE	1300	2000 →		FCD0226	FCD0226	FCD0226/1		
XV 1600 ROAD STAR SILVERADO	1600	1999 → 2002		FCD0287	FCD0287			
XV 1600 WILD STAR SILVERADO	1600	1999 → 2004		FCD0287	FCD0287			
MT-01	1670	2005 → 2006		FCD0298	FCD0298			
MT-01	1670	2007 →		FCD0298	FCD0298			
MT-01S	1670	2009 →		FCD0298	FCD0298			
XV 1670 ROYALS STAR WARRIOR	1670	2002 →		FCD0287	FCD0287			
V MAX 1700	1700	2009 → 2012		FCD1207	FCD1207			
XV 1700 PC ROAD STAR WARRIOR	1700	2003 → 2005		FCD0294	FCD0294			
XV 1900 A MIDNIGHT STAR	1900	2006 → 2012		FCD0299	FCD0299			

YAMAHA ATV

YFM 50 RAPTOR	50	2004 → 2009		FCD0227	FCD0227			
YFM 80 BADGER	80	1992 → 2001		FCD0227	FCD0227			
YFM 80 RAPTOR	80	2002 → 2008		FCD0227	FCD0227			
YFM 80 GRIZZLY	80	2005 → 2008		FCD0227	FCD0227			
YFM 200 (MOTO 4)	200	1985 → 1990		FCD0220	FCD0220			
YFS 200 BLASTER	200	1991 → 2002	FSS0206	FCD0235	FCD0235			
YFS 200 BLASTER	200	2003 → 2006	FSS0206	FCD0235	FCD0235			
YTM 200 TRI MOTO	200	1989 →		FCD1217	FCD1217			
YFM 225 MOTO 4	225	1986 → 1988		FCD1219	FCD1219			
YTM 225 TRI MOTO	225	1985 → 1986	FSS0209	FCD0220	FCD0220			
YFB 250 D/E/F TIMBERWOLF	250	1992 → 1994	FSS0209	FCD0220	FCD0220			
YFB 250 FW TIMBERWOLF	250	1994 → 2000	FSS0209	FCD0220	FCD0220			
YFM 250 W/A/B	250	1990 → 1992	FSS0209	FCD0220	FCD0220			
YFM 250 BEAR TRACKER	250	1999 → 2004	FSS0209	FCD0220	FCD0220			
YFM 250 AN BRUIN 2x4	250	2005 → 2006	FSS0209	FCD0220	FCD0220			
YFM 250 BIG BEAR	250	2007 → 2010	FSS0209	FCD0220	FCD0220			

20044

FERODO

RACING

Updated on November 2020

FCDXXXX
FCDXXXX/1
FCSXXXX/2
FCSXXXX/3

STANDARD
HIGH PERFORMANCE
STANDARD
HIGH PERFORMANCE

FRICITION PLATES ONLY
FRICITION PLATES ONLY
FRICITION PLATES + STEEL PLATES
FRICITION PLATES + STEEL PLATES



KIT RANGE



STANDARD
HIGH PERFORMANCE



STANDARD
HIGH PERFORMANCE

...YAMAHA ATV

YFM 250 RX/RV Raptor	250	2008 → 2009			FCD1202			
YTZ 250 TRI MOTO	250	1985 → 1986	FSS0201		FCD0218			FCS0218/3
YFM 350 FW	350	1985 → 1995			FCD1231			
YFM 350 FW BIG BEAR	350	1987 → 1988			FCD1231			
YFM 350 ERD/ERE/ERF	350	1992 → 1995			FCD1231			
YFM 350 X WARRIOR	350	1992 → 2004			FCD1231			
YFM 350 FX WOLVERINE	350	1995 → 2004			FCD0208			
YFM 350 FW BIG BEAR	350	1996 → 1998			FCD0221			
YFM 350 UH/UJ/UK	350	1996 → 1998			FCD0221			
YFM 350 R RAPTOR	350	2004 → 2009			FCD1231			
YFU 350 TW/IW PRO HAULER	350	1989 → 1990	FSS0209		FCD0220			
YFZ 350 BANSHEE	350	1987 → 2009	FSS0201		FCD1211			
YFM 400 FW KODIAK	400	1993 → 1999			FCD0221			
YFM 400 FP BIG BEAR 4WD	400	2003 → 2004			FCD0221			
YFM 660 RAPTOR RN	660	2001 → 2005			FCD0223	FCD0223/1	FCS0223/2	
YFM 700 RAPTOR	700	2006 → 2009	FSS0204		FCD0295		FCS0295/2	
YFM 700 RAPTOR	700	2010 → 2015	FSS0204		FCD0295		FCS0295/2	

FCDXXXX STANDARD FRICTION PLATES ONLY
FCDXXXX/1 HIGH PERFORMANCE FRICTION PLATES ONLY
FCSXXXX/2 STANDARD FRICTION PLATES + STEEL PLATES
FCSXXXX/3 HIGH PERFORMANCE FRICTION PLATES + STEEL PLATES





CLUTCHES

SCOOTER CENTRIFUGAL APPLICATIONS



MOTORCYCLE



FERODO KIT

CLUTCH SHOE

CLUTCH BELL

APRILIA

AMICO all models	50	1996 →		FCC0535	FCB0018
GULLIVER	50	1997 → 1998		FCC0535	FCB0018
RALLY liquid cooled	50	1996 →		FCC0535	FCB0018
SCARABEO 4T	50	2002 → 2006		FCC0522	FCB0016
SCARABEO STREET	50	2002 → 2006		FCC0522	FCB0016
SCARABEO 4T RESTYLING	50	2006 → 2007		FCC0522	FCB0016
SCARABEO STREET RESTYLING	50	2006 → 2007		FCC0522	FCB0016
SONIC GP	50	1997 →		FCC0535	FCB0018
SONIC SPICE	50	1997 →		FCC0535	FCB0018
SR RACING	50	1997 → 1999		FCC0535	FCB0018
SR STEALTH	50	1997 → 1999		FCC0535	FCB0018
SR WWW	50	1997 → 2001		FCC0535	FCB0018
SR NETSCAPER	50	1998 →		FCC0535	FCB0018
SCARABEO (motore Yamaha)	100	2000 →		FCC0520	FCB0014
SCARABEO 4T	100	2001 → 2004		FCC0522	FCB0016
SCARABEO 4T RESTYLING	100	2006 → 2012		FCC0522	FCB0016
SCARABEO NET	100	2010 →		FCC0522	FCB0016
ATLANTIC	125	2003 → 2006	FCG0550	FCC0550	FCB0031
SPORT CITY	125	2004 → 2005	FCG0550	FCC0550	FCB0031
SPORT CITY EU 3	125	2006 → 2008	FCG0550	FCC0550	FCB0031
SR	125	1999 →	FCG0538		FCB0008
SR	150	1999 →	FCG0538		FCB0008
ARECIFE (spagna)	200	2003 →		FCC0558	FCB0031
ATLANTIC	200	2003 → 2005	FCG0558	FCC0558	FCB0031
SPORT CITY	200	2004 → 2005	FCG0558	FCC0558	FCB0031
SPORT CITY EU3	200	2006 → 2008	FCG0558	FCC0558	FCB0031
ATLANTIC	250	2003 → 2006	FCG0557	FCC0557	FCB0031
LEONARDO	250	1999 → 2001	FCG0539	FCC0539	FCB0025
LEONARDO ST	250	2001 → 2004	FCG0539	FCC0539	FCB0025
SPORT CITY EU3	250	2006 →	FCG0557	FCC0557	FCB0031
ATLANTIC SPRINT	400	2005 → 2008	FCG0549	FCC0549	FCB0011
SCARABEO LIGHT	400	2006 → 2008	FCG0549	FCC0549	FCB0011
ARECIFE (spagna)	500	2002 → 2004	FCG0549	FCC0549	FCB0011
ATLANTIC	500	2002 → 2004	FCG0549	FCC0549	FCB0011
ATLANTIC SPRINT	500	2005 → 2008	FCG0549	FCC0549	FCB0011
SCARABEO	500	2002 → 2006	FCG0549	FCC0549	FCB0011
SCARABEO LIGHT	500	2006 → 2008	FCG0549	FCC0549	FCB0011
SCARABEO IE	500	2007 →	FCG0549	FCC0549	FCB0011
SCARABEO CLASS	500	2010 →	FCG0549	FCC0549	FCB0011

ATALA

CAROSSELLO	50	1997 →		FCC0504	
------------	----	--------	--	---------	--

BENELLI

491 all models	50	1997 →		FCC0535	FCB0018
K2 all models	50	1998 →		FCC0535	FCB0018
K2	100	1999 →		FCC0520	FCB0014

BETA

ARK all models	50	1996 →		FCC0535	FCB0018
CHRONO ruota da 13	50	1994 →		FCC0535	FCB0018

BS VILLA

DIO GP	50	1993 →		FCC0521	FCB0006
DIO SP	50	1993 →		FCC0521	FCB0006
GZ	50	1993 →		FCC0504	
ZX	50	1993 →		FCC0521	FCB0006

CAGIVA

CITY	50	1992 → 1994		FCC0522	FCB0016
------	----	-------------	--	---------	---------

DERBI

ATLANTIS 02	50	1999 →		FCC0522	FCB0016
ATLANTIS 02 H2O	50	2001 →		FCC0522	FCB0016
ATLANTIS 02 WAWÉ	50	2001 →		FCC0522	FCB0016
ATLANTIS 02 BULLET	50	2003 → 2005		FCC0522	FCB0016
ATLANTIS 02 4T	50	2004 →		FCC0522	FCB0016
ATLANTIS 02 RED BULLET	50	2004 →		FCC0522	FCB0016

21000**FERODO**

RACING

Updated on November 2020



FERODO KIT

CLUTCH SHOE

CLUTCH BELL

...DERBI

ATLANTIS 02 TWO CHIC	50	2005 →		FCC0522	FCB0016
ATLANTIS CITY	50	2006 →		FCC0522	FCB0016
GP1	50	2001 → 2004		FCC0522	FCB0016
GP1 EURO2	50	2005 →		FCC0522	FCB0016
HUNTER	50	1995 →		FCC0505	FCB0014
BOULEVARD	125	2002 → 2004	FCG0523	FCC0523	FCB0019
PREDATOR	125	1999 →	FCG0523	FCC0523	FCB0019
ATLANTIS	150	2004 →	FCG0523	FCC0523	FCB0019
BOULEVARD	150	2002 → 2004	FCG0523	FCC0523	FCB0019
PREDATOR	180	1999 →	FCG0523	FCC0523	FCB0019
BOULEVARD	200	2005 →	FCG0556	FCC0556	FCB0019

GILERA

DNA	50	2000 → 2004		FCC0522	FCB0016
DNA GP EXPERIENCE	50	2003 → 2004		FCC0522	FCB0016
DNA	50	2005 → 2007		FCC0522	FCB0016
EASY MOVING	50	1995 →		FCC0522	FCB0016
ICE	50	2001 →		FCC0522	FCB0016
RUNNER	50	1996 →		FCC0522	FCB0016
RUNNER SP	50	1998 →		FCC0522	FCB0016
RUNNER PURE JET	50	2002 → 2006		FCC0522	FCB0016
RUNNER SP	50	2002 → 2006		FCC0522	FCB0016
RUNNER SP RACE	50	2006 →		FCC0522	FCB0016
RUNNER SP SC	50	2006 → 2007		FCC0522	FCB0016
RUNNER PURE JET ST	50	2008 →		FCC0522	FCB0016
RUNNER SP ST	50	2008 →		FCC0522	FCB0016
STALKER (post freno a disco)	50	1997 → 2004		FCC0522	FCB0016
STALKER (post freno a tamburo)	50	1997 → 2004		FCC0522	FCB0016
STORM	50	1994 → 1995		FCC0522	FCB0016
TYPHOON	50	1993 →		FCC0522	FCB0016
TYPHOON	80	1993 →		FCC0522	FCB0016
DNA	125	2001 →	FCG0523	FCC0523	FCB0019
NEXUS EURO 3	125	2007 →	FCG0550	FCC0550	FCB0031
NEXUS IE EURO 3	125	2008 → 2011	FCG0550	FCC0550	FCB0031
RUNNER FX - FXR	125	1997 → 2002	FCG0516	FCC0516	FCB0008
RUNNER	125	1997 → 1999	FCG0516	FCC0516	FCB0008
RUNNER SP	125	1999 →	FCG0516	FCC0516	FCB0008
RUNNER VX / VXR 4T	125	2001 → 2004	FCG0523	FCC0523	FCB0019
RUNNER VX 4T	125	2005 → 2006	FCG0550	FCC0550	FCB0031
RUNNER VX 4T RACE	125	2006 →	FCG0550	FCC0550	FCB0031
RUNNER VX 4T SC	125	2006 → 2007	FCG0550	FCC0550	FCB0031
RUNNER VX 4T ST EURO 3	125	2008 → 2012	FCG0550	FCC0550	FCB0031
TYPHOON	125	1995 → 1998	FCG0516	FCC0516	FCB0008
TYPHOON X - XR	125	1999 → 2000	FCG0516	FCC0516	FCB0008
DNA	180	2001 →	FCG0544	FCC0544	FCB0019
RUNNER FXR	180	1998 →	FCG0538		FCB0008
RUNNER SP	180	1999 →	FCG0538		FCB0008
RUNNER VXR	180	2001 → 2004	FCG0544	FCC0544	FCB0019
RUNNER VX / VXR 4T	200	2002 →	FCG0558	FCC0558	FCB0031
RUNNER VXR 4T	200	2005 → 2006	FCG0558	FCC0558	FCB0031
RUNNER VXR 4T RACE	200	2006 →	FCG0558	FCC0558	FCB0031
RUNNER VXR EURO 3	200	2007 →	FCG0558	FCC0558	FCB0031
RUNNER VXR 4T ST EURO 3	200	2008 →	FCG0558	FCC0558	FCB0031
NEXUS EURO 3	250	2006 →	FCG0557	FCC0557	FCB0031
NEXUS SP EURO 3	250	2006 → 2007	FCG0557	FCC0557	FCB0031
NEXUS	500	2003 → 2005	FCG0537	FCC0537	FCB0011
NEXUS EURO 3	500	2006 → 2011	FCG0549	FCC0549	FCB0011
NEXUS SP EURO 3	500	2006 → 2007	FCG0549	FCC0549	FCB0011

HONDA

DIO ZX	50	1992 →		FCC0521	FCB0006
NH LEAD	50	→ 1986		FCC0109	FCB0006
NH LEAD	50	1987 → 1993		FCC0109	FCB0006
NH LEAD (disk)	50	1988 → 1992		FCC0101	
NH LEAD	50	1994 →		FCC0109	FCB0006
LIFE DIO	50	1994 →		FCC0521	FCB0006
LIFE DIO ZX	50	1994 →		FCC0521	FCB0006
SA ELITE LX	50	1988 → 1990		FCC0521	FCB0006
SA J VISION MET-IN	50	1988 → 1990		FCC0521	FCB0006
SAA VISION	50	1993 →		FCC0521	FCB0006
SFX	50	1995 →		FCC0521	FCB0006
SH	50	1984 → 1987		FCC0101	
SH	50	1988 → 1994		FCC0101	
SH FIFTY	50	1996 →		FCC0101	

HONDA



FERODO KIT

CLUTCH SHOE

CLUTCH BELL

...HONDA

SJ BALI	50	1993 →		FCC0521	FCB0006
SKY	50	1997 →		FCC0521	FCB0006
SRX SHADOW	50	1998 →		FCC0521	FCB0006
SUPER DIO SR	50	1991 → 1992		FCC0521	FCB0006
SUPER DIO ZX	50	1992 →		FCC0521	FCB0006
X8R S SZX	50	1998 →		FCC0521	FCB0006
X8R X SZX	50	1998 →		FCC0521	FCB0006
YUPY	75	1991 →		FCC0101	
NH LEAD	80	1983 → 1984		FCC0101	
NH LEAD	80	1985 → 1988		FCC0101	
NH LEAD	80	1986 → 1987		FCC0101	
LEAD L - M	90	→		FCC0105	FCB0023
GY	125	→	FCG0108	FCC0108	FCB0028
NH LEAD	125	1988 →		FCC0104	
@ NES (tambuto post/rear drum)	125	2000 →	FCG0108	FCC0108	FCB0028
@ NES	125	2009 →	FCG0108	FCC0108	FCB0028
PANTHEON FES	125	1998 → 2002		FCC0102	FCB0009
SH	125	2000 → 2008	FCG0108	FCC0108	FCB0028
SH i	125	2009 → 2012	FCG0108	FCC0108	FCB0028
SH	125	2013 →	FCG0108	FCC0108	FCB0028
@ NES (tambuto post/rear drum)	150	2000 →	FCG0108	FCC0108	FCB0028
@ NES	150	2009 →	FCG0108	FCC0108	FCB0028
PANTHEON FES	150	1998 → 2002		FCC0102	FCB0009
SH	150	2000 → 2008	FCG0108	FCC0108	FCB0028
SH i	150	2009 → 2012	FCG0108	FCC0108	FCB0028
SH	150	2013 →	FCG0108	FCC0108	FCB0028
CN ELITE	250	1985 → 1990	FCG0106	FCC0106	FCB0012
CN HELIX	250	1986 → 1987	FCG0106	FCC0106	FCB0012
CN	250	1988 → 1992	FCG0106	FCC0106	FCB0012
FORESIGHT FES	250	1997 → 2007	FCG0107	FCC0107	FCB0009
JAZZ	250	2001 → 2004	FCG0107	FCC0107	FCB0009
SH i	300	2006 → 2014	FCG0107	FCC0107	FCB0009
SH i ABS	300	2006 →	FCG0107	FCC0107	FCB0009

HSC

HSC 01	50	1992 →		FCC0521	FCB0006
SR DIO	50	1992 →		FCC0521	FCB0006
ZR	50	1992 →		FCC0521	FCB0006
ZX DIO	50	1992 →		FCC0521	FCB0006

ITALJET

DRAGSTER	50	1997 →		FCC0535	FCB0018
FORMULA	50	1994 →		FCC0504	
TORPEDO	50	1997 →		FCC0504	
VELOCIFERO	50	1994 →		FCC0504	

KYMCO

CX CURIO SUPER	50	1994 →		FCC0521	FCB0006
DJW	50	1994 →		FCC0521	FCB0006
DJX	50	1992 →		FCC0521	FCB0006
DJY	50	1993 →		FCC0521	FCB0006
HEROISM	50	1995 → 1996		FCC0521	FCB0006
K 12	50	1995 →		FCC0521	FCB0006
KB	50	1994 →		FCC0521	FCB0006
SNIPER DD	50	1994 →		FCC0521	FCB0006
AGILITY 4T	125	2005 → 2008	FCG0108	FCC0108	FCB0028
AGILITY R 16	125	2008 → 2009	FCG0108	FCC0108	FCB0028
AGILITY RS	125	2009 →	FCG0108	FCC0108	FCB0028
DINK	125	1996 → 2005	FCG0540	FCC0540	FCB0022
GRAND DINK	125	2001 → 2004		FCC0108	
HEROISM	125	1995 → 1997	FCG0541	FCC0541	FCB0028
LIKE	125	2009 →	FCG0108	FCC0108	FCB0028
MOVIE	125	1999 → 2000	FCG0108	FCC0108	FCB0028
MOVIE XL	125	2001 → 2004	FCG0108	FCC0108	FCB0028
MOVIE EURO 3	125	2006 → 2007	FCG0108	FCC0108	FCB0028
PEOPLE	125	1999 → 2000	FCG0108	FCC0108	FCB0028
PEOPLE EURO 2	125	2003 → 2004	FCG0108	FCC0108	FCB0028
PEOPLE S	125	2005 → 2006	FCG0108	FCC0108	FCB0028
PEOPLE S DD	125	2007 → 2008	FCG0108	FCC0108	FCB0028
PEOPLE EURO 3	125	2007 →	FCG0108	FCC0108	FCB0028
SUPER 8	125	2008 → 2009	FCG0108	FCC0108	FCB0028
VIVIO	125	2000 →	FCG0108	FCC0108	FCB0028



FERODO KIT

CLUTCH SHOE

CLUTCH BELL

...KYMCO

AGILITY R 16	150	2008 →	FCG0108	FCC0108	FCB0028
DINK LX	150	1998 → 2000	FCG0540	FCC0540	FCB0022
GRAND DINK	150	2001 → 2004		FCC0108	
HEROISM	150	1995 → 1997	FCG0541	FCC0541	FCB0028
MOVIE XL	150	2001 → 2004	FCG0108	FCC0108	FCB0028
MOVIE EURO 3	150	2006 → 2007	FCG0108	FCC0108	FCB0028
PEOPLE	150	1999 → 2006	FCG0108	FCC0108	FCB0028
PEOPLE EURO 3	150	2007 → 2008	FCG0108	FCC0108	FCB0028
VIVIO	150	2001 →	FCG0108	FCC0108	FCB0028
AGILITY i R 16	200	2009 → 2011		FCC0108	
DOWNTOWN I	200	2010 →	FCG0563	FCC0563	FCB0044
LIKE i	200	2009 →	FCG0108	FCC0108	FCB0028
PEOPLE S	200	2005 → 2006	FCG0108	FCC0108	FCB0028
PEOPLE S I	200	2007 →	FCG0108	FCC0108	FCB0028
PEOPLE GTI	200	2010 →	FCG0563	FCC0563	FCB0044
B&W BET & WIN	250	2000 → 2002		FCC0543	FCB0029
B&W EURO 2	250	2003 →		FCC0543	FCB0029
GRAND DINK	250	2001 → 2002		FCC0543	FCB0029
GRAND DINK EURO 2	250	2003 → 2004		FCC0543	FCB0029
PEOPLE	250	2003 → 2005		FCC0543	FCB0029
PEOPLE S	250	2006 →		FCC0543	FCB0029
PEOPLE S i	250	2007 →		FCC0543	FCB0029
XCITING	250	2005 →		FCC0543	FCB0029
XCITING i	250	2006 →		FCC0543	FCB0029
YUP	250	2003 →		FCC0543	FCB0029
DOWNTOWN I	300	2009 → 2011	FCG0563	FCC0563	FCB0044
DOWNTOWN I ABS	300	2010 → 2011	FCG0563	FCC0563	FCB0044
DOWNTOWN ABS	300	2010 → 2011	FCG0563	FCC0563	FCB0044
K-XCT I ABS	300	2012 → 2014	FCG0563	FCC0563	FCB0044
PEOPLE S I	300	2008 →		FCC0543	FCB0029
PEOPLE GTI	300	2010 → 2011	FCG0563	FCC0563	FCB0044
PEOPLE GTI ABS	300	2012 →	FCG0563	FCC0563	FCB0044
XCITING I	300	2008 →		FCC0543	FCB0029
XCITING I R	300	2008 →		FCC0543	FCB0029

MALAGUTI

CENTRO 4T	50	2008 →		FCC0535	FCB0018
CR1 CROSSER	50	1997 → 1998		FCC0504	
ET all models	50	1990 → 1994		FCC0553	
F 12 PHANTOM LC	50	1994 → 1998		FCC0535	FCB0018
F 15 FIREFOX	50	1996 → 1997		FCC0535	FCB0018
F 12 PHANTOM Twin disk	50	1998 →		FCC0535	FCB0018
F 12 PHANTOM LC	50	1999 → 2000		FCC0535	FCB0018
F 10 RESTYLING	50	2001 → 2006		FCC0535	FCB0018
F 12 PHANTOM RESTYLING	50	2001 → 2004		FCC0535	FCB0018
F 12 R PHANTOM LC	50	2001 → 2005		FCC0535	FCB0018
F 12 PHANTOM LC RESTYLING	50	2003 → 2004		FCC0535	FCB0018
F 12 R PHANTOM LC	50	2007 → 2010		FCC0535	FCB0018
F 10 AC	50	2008 →		FCC0535	FCB0018
GRIZZLY RCX 10 (motore S5N)	50	1990 → 2000		FCC0553	
GRIZZLY RCX 12 (motore S5NF)	50	1990 → 2000		FCC0553	
GRIZZLY RCX 10 (motore S6)	50	2001 → 2002		FCC0554	
GRIZZLY RCX 12 (motore S6)	50	2001 → 2002		FCC0554	
YESTERDAY	50	1998 →		FCC0535	FCB0018
BLOG	125	2009 → 2011	FCG0108	FCC0108	FCB0028
CENTRO IE	125	2008 → 2009	FCG0108	FCC0108	FCB0028
CENTRO SL	125	2009 → 2011	FCG0108	FCC0108	FCB0028
CIAK	125	2000 → 2001	FCG0108	FCC0108	FCB0028
CIAK RESTYLING	125	2003 →	FCG0108	FCC0108	FCB0028
CIAK MASTER	125	2004 →	FCG0108	FCC0108	FCB0028
CIAK MASTER EURO 3	125	2006 →	FCG0108	FCC0108	FCB0028
F 18 WARRIOR	125	2000 → 2002	FCG0540	FCC0540	FCB0022
MADISON	125	1999 → 2002	FCG0511	FCC0511	FCB0007
MADISON 3	125	2006 → 2009	FCG0553	FCC0511	FCB0030
CIAK	150	2000 → 2002	FCG0108	FCC0108	FCB0028
CIAK MASTER	150	2003 →	FCG0108	FCC0108	FCB0028
CIAK RESTYLING EURO 2	150	2004 →	FCG0108	FCC0108	FCB0028
F 18 WARRIOR	150	2000 → 2002	FCG0540	FCC0540	FCB0022
BLOG	160	2009 → 2011	FCG0108	FCC0108	FCB0028
CENTRO IE	160	2008 → 2009	FCG0108	FCC0108	FCB0028
CENTRO SL	160	2009 → 2011	FCG0108	FCC0108	FCB0028
MADISON R	180	2001 → 2002	FCG0544	FCC0544	FCB0019
CIAK MASTER EURO 2	200	2006 →	FCG0108	FCC0108	FCB0028
MADISON	200	1999 → 2001	FCG0532	FCC0532	FCB0019
MADISON S RESTYLING	200	2002 → 2003	FCG0532	FCC0532	FCB0019



FERODO KIT

CLUTCH SHOE

CLUTCH BELL

...MALAGUTI

PHANTOM MAX	200	2003 →	FCG0532	FCC0532	FCB0019
MADISON S	250	1999 → 2001	FCG0539	FCC0539	FCB0025
MADISON RS RESTYLING	250	2004 →	FCG0557	FCC0557	FCB0031
PASSWORD	250	2005 → 2006	FCG0517	FCC0517	
PASSWORD EU 3	250	2007 → 2008	FCG0557	FCC0557	FCB0031
MADISON K	400	2002 →	FCG0506	FCC0506	FCB0005
MADISON K RESTYLING	400	2002 → 2004	FCG0506	FCC0506	FCB0005
SPIDERMAX GT	500	2004 → 2005	FCG0549	FCC0549	FCB0011
SPIDERMAX GT EURO 3	500	2006 →	FCG0549	FCC0549	FCB0011

MBK

CW R BOOSTER ROAD	50	1994 → 1995		FCC0535	FCB0018
CW RS BOOSTER NG	50	1995 → 1998		FCC0535	FCB0018
CW BOOSTER SPIRIT	50	1996 → 1998		FCC0535	FCB0018
CW RSP BOOSTER ROCKET	50	1997 → 1998		FCC0535	FCB0018
CW BOOSTER NG	50	1999 →		FCC0535	FCB0018
CW BOOSTER SPIRIT	50	1999 →		FCC0535	FCB0018
CW RS BOOSTER NG	50	1999 → 2003		FCC0535	FCB0018
CW BOOSTER	50	2001 →		FCC0535	FCB0018
CW L BOOSTER	50	2001 →		FCC0535	FCB0018
NITRO	50	1997 →		FCC0535	FCB0018
OVETTO	50	1997 →		FCC0535	FCB0018
SORRISO	50	1997 →		FCC0535	FCB0018
YA R FORTE	50	1994 → 1996		FCC0505	FCB0014
YE EVOLIS	50	1992 → 1995		FCC0505	FCB0014
YM FIZZ	50	1994 → 1995		FCC0505	FCB0014
YN R OVETTO	100	2000 →		FCC0520	FCB0014
YQ NITRO	100	2000 → 2002		FCC0520	FCB0014
YW BOOSTER	100	1999 → 2001		FCC0520	FCB0014
XN DOODO	125	2000 → 2001	FCG0511	FCC0511	FCB0007
XQ THUNDER	125	2001 →	FCG0511	FCC0511	FCB0007
YP SKYLINER	125	1998 → 2000	FCG0511	FCC0511	FCB0007
YP SKYLINER	125	2001 →	FCG0511	FCC0511	FCB0007
YP SKYLINER	250	2000 → 2001	FCG0539	FCC0539	FCB0025
YP SKYLINER	250	2002 → 2003	FCG0517	FCC0517	
KILIBRE	300	2003 → 2006	FCG0517	FCC0517	

PEUGEOT

BUXY	50	1994 →		FCC0521	FCB0006
BUXY RS	50	1994 →		FCC0521	FCB0006
METROPOLIS	50	→		FCC0101	
SPEEDAKE	50	1995 →		FCC0521	FCB0006
SPEEDFIGHT (Pinza Brembo)	50	1996 →		FCC0521	FCB0006
SPEEDFIGHT M (Pinza AJP)	50	1997 → 1998		FCC0521	FCB0006
SPEEDFIGHT M (Pinza Heng-Tong)	50	1997 →		FCC0521	FCB0006
SPEEDFIGHT (raff. acqua pinze AJP)	50	1998 →		FCC0521	FCB0006
SQUAB	50	1996 →		FCC0521	FCB0006
ST RAPIDO	50	→		FCC0521	FCB0006
SV GEO	50	1992 →		FCC0521	FCB0006
SV GEO (all models)	50	1993 →		FCC0521	FCB0006
SV ROLLAND GARROS	50	1993 →		FCC0521	FCB0006
SV SPORT	50	1993 →		FCC0521	FCB0006
SV T (forcella telescopica)	50	1993 →		FCC0521	FCB0006
TREKKER	50	1997 →		FCC0521	FCB0006
TREKKER (forcelle Paioli)	50	1997 →		FCC0521	FCB0006
ZENITH	50	1994 → 1995		FCC0521	FCB0006
ELYSEO	100	1998 → 2001		FCC0504	
ELYSEO	100	2002 →	FCG0507	FCC0507	FCB0021
LOOXOR	100	2001 →	FCG0507	FCC0507	FCB0021
SPEEDFIGHT	100	1997 → 2000	FCG0507	FCC0507	FCB0021
SV L	100	1999 → 2001	FCG0507	FCC0507	FCB0021
TREKKER	100	1998 →	FCG0507	FCC0507	FCB0021
VIVACITY	100	1999 → 2001	FCG0507	FCC0507	FCB0021
X FIGHT	100	2000 → 2001	FCG0507	FCC0507	FCB0021
ELYSEO	125	1998 → 1999	FCG0524	FCC0524	FCB0017
SV	250	2001 →	FCG0107	FCC0107	FCB0009

PGO

BIG MAX	50	1994 → 2002		FCC0521	FCB0006
---------	----	-------------	--	----------------	----------------



FERODO KIT

CLUTCH SHOE

CLUTCH BELL

PIAGGIO

FLY 2T	50	2005 →		FCC0522	FCB0016
FREE	50	1993 →		FCC0522	FCB0016
FREE (ruote in lega)	50	1996 →		FCC0522	FCB0016
LIBERTY 2T	50	1997 →		FCC0522	FCB0016
LIBERTY 4T	50	2000 → 2001		FCC0522	FCB0016
LIBERTY RST 2T	50	2004 →		FCC0522	FCB0016
LIBERTY RST 4T	50	2004 →		FCC0522	FCB0016
NRG	50	1994 → 1996		FCC0522	FCB0016
NRG	50	1996 →		FCC0522	FCB0016
NRG MC2	50	1996 →		FCC0522	FCB0016
NRG EXTREME	50	1999 → 2000		FCC0522	FCB0016
NRG MC3	50	2001 → 2004		FCC0522	FCB0016
NTT	50	→ 1995		FCC0522	FCB0016
QUARTZ	50	1992 →		FCC0522	FCB0016
SFERA	50	1991 → 1994		FCC0531	
SFERA RST	50	1995 →		FCC0522	FCB0016
VELOFAX	50	1996 →		FCC0522	FCB0016
VESPA ET2	50	1997 →		FCC0522	FCB0016
VESPA ET2 INIEZIONE	50	1999 →		FCC0522	FCB0016
VESPA ET2 4T	50	2000 → 2001		FCC0522	FCB0016
VESPA LX 2T	50	2005 →		FCC0522	FCB0016
VESPA LX 4T	50	2005 →		FCC0522	FCB0016
ZIP	50	1992 → 1993		FCC0522	FCB0016
ZIP FAST RIDER	50	1993 → 1994		FCC0522	FCB0016
ZIP RST	50	1996 → 1997		FCC0522	FCB0016
ZIP SP	50	1996 →		FCC0522	FCB0016
ZIP RST	50	1998 → 1999		FCC0522	FCB0016
ZIP	50	1999 →		FCC0522	FCB0016
ZIP 4T	50	2000 → 2004		FCC0522	FCB0016
ZIP CATALYZED	50	2000 →		FCC0522	FCB0016
ZIP HT	50	2000 →		FCC0522	FCB0016
DIESIS	100	2001 →		FCC0522	FCB0016
FREE	100	2001 →		FCC0522	FCB0016
BEVERLY	125	2001 →	FCG0523	FCC0523	FCB0019
BEVERLY RST	125	2004 → 2007	FCG0550	FCC0550	FCB0031
BEVERLY EURO 3 MIC	125	2007 →	FCG0550	FCC0550	FCB0031
BEVERLY EURO 3	125	2007 → 2008	FCG0550	FCC0550	FCB0031
BEVERLY EURO 3 SPORT	125	2007 → 2008	FCG0550	FCC0550	FCB0031
BEVERLY EURO 3 TOURER	125	2008 → 2010	FCG0550	FCC0550	FCB0031
BEVERLY RST 4T 4V IE EURO 3	125	2010 → 2011	FCG0550	FCC0550	FCB0031
CARNABY	125	2007 → 2010	FCG0550	FCC0550	FCB0031
COSA CL / CL2 125	125	1988 → 1991			FCB0004
FLY	125	2005 → 2008	FCG0551	FCC0523	FCB0031
HEXAGON	125	1994 → 1997	FCG0516	FCC0516	FCB0008
HEXAGON LX	125	1998 →	FCG0516	FCC0516	FCB0008
HEXAGON GTX 4T	125	1998 → 1999	FCG0523	FCC0523	FCB0019
HEXAGON LX4	125	1998 → 1999	FCG0527	FCC0527	FCB0020
HEXAGON GTX 4T	125	2000 →	FCG0550	FCC0550	FCB0031
LIBERTY	125	1998 → 2000	FCG0527	FCC0527	FCB0020
LIBERTY	125	2001 →	FCG0523	FCC0523	FCB0019
LIBERTY RST	125	2004 → 2005	FCG0550	FCC0550	FCB0031
LIBERTY RST PTT	125	2005 → 2011	FCG0550	FCC0550	FCB0031
LIBERTY 4T SPORT EURO3	125	2006 → 2008	FCG0550	FCC0550	FCB0031
LIBERTY 4T	125	2006 → 2007	FCG0550	FCC0550	FCB0031
LIBERTY SPORT	125	2006 →	FCG0550	FCC0550	FCB0031
LIBERTY 4T EURO3	125	2007 → 2008	FCG0550	FCC0550	FCB0031
MP3	125	2006 → 2008	FCG0550	FCC0550	FCB0031
MP3 IE	125	2008 → 2009	FCG0550	FCC0550	FCB0031
MP3 IBRIDO	125	2009 → 2010	FCG0550	FCC0550	FCB0031
MP3 YOURBAN ERL	125	2011 → 2013	FCG0550	FCC0550	FCB0031
MP3 IE TOURING	125	2011 → 2012	FCG0550	FCC0550	FCB0031
SFERA 4T	125	1995 → 1997	FCG0527	FCC0527	FCB0020
SKIPPER	125	1993 → 1999	FCG0516	FCC0516	FCB0008
SKIPPER 4T	125	1998 →	FCG0523	FCC0523	FCB0019
SUPER HEXAGON GTX	125	→ 2000	FCG0523	FCC0523	FCB0019
SUPER HEXAGON GTX	125	2001 → 2002	FCG0550	FCC0550	FCB0031
VESPA ET4	125	1996 → 1998	FCG0527	FCC0527	FCB0020
VESPA ET4	125	1999 → 2002	FCG0550	FCC0550	FCB0031
VESPA GRANTURISMO L (pinza HengTong)	125	2003 →	FCG0550	FCC0550	FCB0031
VESPA GRANTURISMO L (pinza Grimeca)	125	2003 →	FCG0550	FCC0550	FCB0031
VESPA LX	125	2005 → 2006	FCG0551	FCC0523	FCB0031
VESPA LX EURO 3	125	2006 → 2007	FCG0550	FCC0550	FCB0031
VESPA S 4T IE & COLLEGE	125	2009 → 2010	FCG0550	FCC0550	FCB0031
X10 4T 4V IE	125	2012 →	FCG0550	FCC0550	FCB0031
X7	125	2007 → 2009		FCC0550	
X8	125	2004 →	FCG0523	FCC0523	FCB0019



FERODO KIT

CLUTCH SHOE

CLUTCH BELL

...PIAGGIO

X8 (pinza HengTong)	125	2005 → 2006	FCG0550	FCC0550	FCB0031
X8 STREET EURO 3	125	2006 →	FCG0550	FCC0550	FCB0031
X8 PREMIUM EURO 2	125	2006 →	FCG0550	FCC0550	FCB0031
X9 EVOLUTION	125	2001 → 2002	FCG0523	FCC0523	FCB0019
X9 EVOLUTION	125	2003 → 2004	FCG0550	FCC0550	FCB0031
X9 EVOLUTION	125	2005 → 2007	FCG0550	FCC0550	FCB0031
X EVO	125	2007 → 2012	FCG0550	FCC0550	FCB0031
ZIP 4T	125	2000 → 2002	FCG0523	FCC0523	FCB0019
COSA CL / CL2 150	150	1988 → 1991			FCB0004
FLY	150	2005 → 2007	FCG0551	FCC0523	FCB0031
FLY EURO 3	150	2008 → 2010	FCG0551	FCC0523	FCB0031
HEXAGON	150	1994 → 1999	FCG0516	FCC0516	FCB0008
LIBERTY LE	150	2000 → 2002	FCG0523	FCC0523	FCB0019
LIBERTY 4T	150	2008 →	FCG0523	FCC0523	FCB0019
LIBERTY 4T SPORT	150	2008 →	FCG0523	FCC0523	FCB0019
SKIPPER	150	1993 → 1999	FCG0516	FCC0516	FCB0008
SKIPPER 4T	150	2000 → 2002	FCG0523	FCC0523	FCB0019
VESPA ET4	150	1996 → 1998	FCG0523	FCC0523	FCB0019
VESPA ET4	150	1999 → 2002	FCG0550	FCC0550	FCB0031
VESPA LX	150	2005 → 2006	FCG0551	FCC0523	FCB0031
VESPA LX EURO 3	150	2006 → 2007	FCG0550	FCC0550	FCB0031
VESPA S 4T IE & COLLEGE	150	2009 → 2010	FCG0550	FCC0550	FCB0031
X8 STREET EURO 3	150	2006 →	FCG0550	FCC0550	FCB0031
HEXAGON LX	180	1998 →	FCG0538		FCB0008
HEXAGON GTX 4T	180	1998 → 2000	FCG0544	FCC0544	FCB0019
HEXAGON GTX 4T	180	2001 →	FCG0559	FCC0544	FCB0031
SUPER EXAGON GTX	180	→ 2000	FCG0523	FCC0523	FCB0019
SUPER EXAGON GTX	180	2001 → 2004	FCG0559	FCC0544	FCB0031
VESPA SS 180	180	1975 →			FCB0004
X9 AMALFI	180	2000 → 2003	FCG0544	FCC0544	FCB0019
BEVERLY	200	2001 → 2006	FCG0545	FCC0545	FCB0019
CARNABY	200	2007 → 2010	FCG0558	FCC0558	FCB0031
COSA 200	200	1989 → 1991			FCB0004
COSA 1 200	200	1989 → 1991			FCB0004
LIBERTY RST	200	2004 → 2005	FCG0559	FCC0544	FCB0031
LIBERTY 4T SPORT EURO 3	200	2006 → 2007	FCG0559	FCC0544	FCB0031
LIBERTY	200	2006 →	FCG0559	FCC0544	FCB0031
LIBERTY SPORT	200	2006 →	FCG0559	FCC0544	FCB0031
LIBERTY 4T EURO3	200	2007 → 2008	FCG0559	FCC0544	FCB0031
VESPA GRANTURISMO L	200	2003 → 2005	FCG0532	FCC0532	FCB0019
VESPA GRANTURISMO	200	2006 →	FCG0558	FCC0558	FCB0031
VESPA PE 200	200	1983 →			FCB0004
VESPA PX E 200	200	1978 →			FCB0004
VESPA PX ARCOBALENO 200	200	1983 →			FCB0004
VESPA RALLY 200	200	1975 →			FCB0004
X8	200	2004 → 2005	FCG0547	FCC0547	FCB0019
X8	200	2005 →	FCG0552	FCC0547	FCB0031
X8	200	2006 →	FCG0558	FCC0558	FCB0031
X9 EVOLUTION	200	2002 → 2003	FCG0545	FCC0545	FCB0019
BEVERLY LEADER	250	2004 →	FCG0546	FCC0545	FCB0031
BEVERLY RST	250	2004 → 2005	FCG0557	FCC0557	FCB0031
BEVERLY EURO 3 IE	250	2006 → 2008	FCG0557	FCC0557	FCB0031
BEVERLY SPORT	250	2006 → 2008	FCG0557	FCC0557	FCB0031
BEVERLY	250	2006 → 2007	FCG0557	FCC0557	FCB0031
BEVERLY CRUISER	250	2007 → 2009	FCG0557	FCC0557	FCB0031
BEVERLY EURO 3 MIC	250	2007 →	FCG0557	FCC0557	FCB0031
BEVERLY EURO 3 TOURER	250	2008 → 2009	FCG0557	FCC0557	FCB0031
CARNABY	250	2008 →	FCG0557	FCC0557	FCB0031
HEXAGON	250	1998 →	FCG0106	FCC0106	FCB0012
MP3	250	2006 → 2008	FCG0557	FCC0557	FCB0031
MP3 LT	250	2008 → 2009	FCG0557	FCC0557	FCB0031
MP3 MIC	250	2008 → 2009	FCG0557	FCC0557	FCB0031
VESPA GTS	250	2005 →	FCG0557	FCC0557	FCB0031
VESPA GTV	250	2006 →	FCG0557	FCC0557	FCB0031
X7 EURO 3	250	2008 →	FCG0557	FCC0557	FCB0031
X8	250	2005 →	FCG0557	FCC0557	FCB0031
X9	250	2000 → 2003	FCG0107	FCC0107	FCB0009
X9 AMALFI	250	2000 →	FCG0107	FCC0107	FCB0009
X9 EVOLUTION	250	2004 → 2006	FCG0557	FCC0557	FCB0031
X EVO EVO	250	2007 → 2013	FCG0557	FCC0557	FCB0031
BEVERLY TOURER EURO 3	300	2009 → 2010	FCG0557	FCC0557	FCB0031
CARNABY CRUISER	300	2009 →	FCG0557	FCC0557	FCB0031
MP3 4T 4V IE LT IBRIDO	300	2010 → 2011	FCG0557	FCC0557	FCB0031
MP3 IE LT	300	2010 → 2011	FCG0557	FCC0557	FCB0031
MP3 IE MIC	300	2010 → 2011	FCG0557	FCC0557	FCB0031
MP3 4T 4V IE ERL IBRIDO	300	2010 → 2013	FCG0557	FCC0557	FCB0031

21006**FERODO**

RACING

Updated on November 2020



FERODO KIT

CLUTCH SHOE

CLUTCH BELL

...PIAGGIO

MP3 IE LT - IE LT SPORT	300	2011 → 2013	FCG0557	FCC0557	FCB0031
MP3 IE LT TOURING	300	2011 → 2013	FCG0557	FCC0557	FCB0031
MP3 IE TOURING	300	2011 → 2012	FCG0557	FCC0557	FCB0031
MP3 YOURBAN ERL	300	2011 → 2015	FCG0557	FCC0557	FCB0031
MP3 YOURBAN LT ERL	300	2011 → 2012	FCG0557	FCC0557	FCB0031
MP3 LT BUSINESS ABS	300	2014 →	FCG0557	FCC0557	FCB0031
MP3 SPORT ABS	300	2014 →	FCG0557	FCC0557	FCB0031
VESPA GTS SUPER	300	2008 →	FCG0557	FCC0557	FCB0031
VESPA GTS SUPER SPORT	300	2011 →	FCG0557	FCC0557	FCB0031
VESPA GTV IE	300	2011 →	FCG0557	FCC0557	FCB0031
VESPA GTS IE	300	2012 →	FCG0557	FCC0557	FCB0031
X7 EVO IE EURO3	300	2009 → 2011	FCG0557	FCC0557	FCB0031
X7 EVO IE	300	2011 →	FCG0557	FCC0557	FCB0031
BEVERLY EURO 3	400	2006 → 2008	FCG0549	FCC0549	FCB0011
BEVERLY TOURER EURO3	400	2008 → 2010	FCG0549	FCC0549	FCB0011
MP3	400	2007 → 2008	FCG0549	FCC0549	FCB0011
MP3 IE LT - IE LT SPORT	400	2008 → 2010	FCG0549	FCC0549	FCB0011
MP3 MIC	400	2008 → 2010	FCG0549	FCC0549	FCB0011
MP3 LT	400	2009 →	FCG0549	FCC0549	FCB0011
MP3 IE LT TOURING	400	2011 →	FCG0549	FCC0549	FCB0011
MP3 RL TOURING	400	2011 →	FCG0549	FCC0549	FCB0011
X8	400	2006 →	FCG0549	FCC0549	FCB0011
X8 EURO 3	400	2006 → 2008	FCG0549	FCC0549	FCB0011
X EVO EURO 3	400	2007 → 2011	FCG0549	FCC0549	FCB0011
BEVERLY	500	2002 → 2004	FCG0537	FCC0537	FCB0011
BEVERLY	500	2005 → 2006	FCG0549	FCC0549	FCB0011
BEVERLY EURO 3	500	2006 →	FCG0549	FCC0549	FCB0011
BEVERLY CRUISER	500	2007 → 2012	FCG0549	FCC0549	FCB0011
MP3 LT SPORT - BUSINESS	500	2011 → 2013	FCG0569	FCC0569	FCB0011
MP3 RL SPORT - BUSINESS	500	2011 → 2012	FCG0569	FCC0569	FCB0011
MP3 LT BUSINESS ABS	500	2014 →	FCG0569	FCC0569	FCB0011
MP3 SPORT ABS	500	2014 →	FCG0569	FCC0569	FCB0011
X10 4T 4V IE	500	2012 →	FCG0569	FCC0569	FCB0011
X9	500	2001 → 2003	FCG0549	FCC0549	FCB0011
X9 EVOLUTION	500	2003 → 2004	FCG0537	FCC0537	FCB0011
X9 EVOLUTION ABS	500	2006 → 2007	FCG0549	FCC0549	FCB0011

RIZZATO

VAMOS	50	→		FCC0504	
-------	----	---	--	----------------	--

SACHS

SACHS	50	→		FCC0508	
-------	----	---	--	----------------	--

SUZUKI

ADRESS	50	1990 → 1991		FCC0504	
AP	50	1995 →		FCC0504	
AY KATANA	50	1997 →		FCC0504	
SEPIA	50	1992 →		FCC0504	
SEPIA AU ZZ	50	1996 →		FCC0504	
BURGMAN UH	125	2002 → 2006		FCC0548	
BURGMAN UH	125	2007 → 2011	FCG0567	FCC0567	FCB0046
EPICURO UC	125	1998 → 2000		FCC0548	
SIXTEEN UX	125	2008 → 2011	FCG0567	FCC0567	FCB0046
BURGMAN UH	150	2002 → 2006		FCC0548	
EPICURO UC	150	1999 → 2000		FCC0548	
EPICURO UC	150	2001 →		FCC0548	
SIXTEEN UX	150	2008 → 2011	FCG0567	FCC0567	FCB0046
BURGMAN UH	200	2007 → 2013	FCG0566	FCC0566	FCB0045
BURGMAN AN	250	1996 → 2006		FCC0301	
BURGMAN AN	400	1998 → 2006	FCG0506	FCC0506	FCB0005
BURGMAN AN	400	2007 → 2015	FCG0565	FCC0565	FCB0036

SYM

JOYRIDE	125	2001 → 2004	FCG0541	FCC0541	FCB0028
JOYRIDE EURO 2	125	2005 → 2006	FCG0108	FCC0108	FCB0028
JOYRIDE EURO 3	125	2007 →	FCG0108	FCC0108	FCB0028
JOYRIDE EVO	125	2010 →	FCG0108	FCC0108	FCB0028
JOYRIDE	150	2001 → 2002	FCG0541	FCC0541	FCB0028
HD EVO EURO 2	200	2005 → 2006	FCG0541	FCC0541	FCB0028
HD EVO I EURO 3	200	2007 → 2010	FCG0541	FCC0541	FCB0028
HD EVO I EURO 3 (tamburo post)	200	2008 → 2009	FCG0541	FCC0541	FCB0028



FERODO KIT

CLUTCH SHOE

CLUTCH BELL

...SYM

GTS	250	2007 → 2008		FCC0517	
JOYMAX	250	2005 → 2007		FCC0517	
JOYMAX I EURO 3	250	2007 → 2008		FCC0517	
CITYCOM	300	2008 → 2009		FCC0517	
CITYCOM EFI	300	2010 → 2011		FCC0517	
CITYCOM I CBS	300	2012 →		FCC0517	
JOYMAX EVO	300	2009 →		FCC0517	
JOYMAX I EVO	300	2010 →		FCC0517	
JOYMAX I	300	2012 →		FCC0517	

SYM ATV

TRACK RUNNER	200	2006 → 2007	FCG0108	FCC0108	FCB0028
--------------	-----	-------------	---------	---------	---------

YAMAHA

AEROX LC YQ	50	1997 →		FCC0535	FCB0018
BW S	50	1997 →		FCC0535	FCB0018
BWS 50 SPY	50	1997 → 2002		FCC0535	FCB0018
NEOS YN	50	1997 →		FCC0535	FCB0018
WHY	50	1997 →		FCC0535	FCB0018
ZEST YE	50	1993 → 1996		FCC0535	FCB0018
ZEST YE	50	1997 →		FCC0505	FCB0014
JOG	90	1990 →		FCC0505	FCB0014
AEROX YQ	100	1999 → 2002		FCC0520	FCB0014
BW S	100	1999 → 2001		FCC0520	FCB0014
NEOS YN	100	1999 → 2002		FCC0520	FCB0014
BWS YW	125	2010 →	FCG0511	FCC0511	FCB0007
CYGNUS R XC	125	1999 → 2003	FCG0511	FCC0511	FCB0007
CYGNUS F XC	125	2000 →	FCG0511	FCC0511	FCB0007
CYGNUS X NXC	125	2004 → 2011	FCG0511	FCC0511	FCB0007
MAJESTY YP	125	1998 → 2000	FCG0511	FCC0511	FCB0007
MAJESTY YP E	125	2001 → 2002	FCG0511	FCC0511	FCB0007
MAXSTER XQ	125	2001 → 2002	FCG0511	FCC0511	FCB0007
X-CITY VP	125	2008 → 2011	FCG0564	FCC0564	FCB0025
X-MAX YP R	125	2006 → 2013	FCG0564	FCC0564	FCB0025
X-MAX ABS YP R	125	2011 →	FCG0564	FCC0564	FCB0025
X-MAX ABS YP RA	125	2013 → 2014	FCG0564	FCC0564	FCB0025
X-MAX YP R	125	2014 →	FCG0564	FCC0564	FCB0025
FLY ONE R XC	150	1998 →			FCB0007
MAJESTY YP	250	1996 → 1998	FCG0539	FCC0539	FCB0025
MAJESTY DX YP	250	1998 → 1999	FCG0539	FCC0539	FCB0025
MAJESTY YP	250	2000 → 2003	FCG0517	FCC0517	
MAJESTY ABS YP	250	2003 →	FCG0517	FCC0517	
X-CITY VP	250	2007 → 2013	FCG0517	FCC0517	
X-MAX YP R	250	2005 → 2013	FCG0517	FCC0517	
X-MAX BLACK YP R	250	2009 →	FCG0517	FCC0517	
X-MAX ABS YP RA	250	2011 → 2014	FCG0517	FCC0517	
X-MAX SPORT YP R	250	2011 → 2012	FCG0517	FCC0517	
X-MAX YP R	250	2014 →	FCG0517	FCC0517	
VERSITY XC	300	2003 → 2006	FCG0517	FCC0517	
MAJESTY YP	400	2004 → 2011		FCC0560	
MAJESTY ABS YP	400	2007 → 2011		FCC0560	
X-MAX YP R	400	2013 → 2015		FCC0560	
X-MAX ABS MOMODESIGN YP RA	400	2014 →		FCC0560	
X-MAX ABS YP RA	400	2014 → 2015		FCC0560	
X-MAX MOMODESIGN YP R	400	2014 →		FCC0560	



CLUTCH KITS XREF COMPETITORS TO FERODO



MOTORCYCLE

CLUTCHES X-REF

COMPETITORS TO FERODO

EBC	Ferodo
CK 1105	FCD0108
CK 1107	FCD0167/1
CK 1119	FCS0132/3
CK 1130	FCD0154
CK 1135	FCD0120/1
CK 1140	FCD0111
CK 1141	FCD0237
CK 1144	FCD0133
CK 1145	FCD0134
CK 1146	FCD0162
CK 1147	FCD0135
CK 1149	FCD0126
CK 1150	FCD0104
CK 1151	FCD0123
CK 1152	FCS0101/3
CK 1153	FCS0126/2
CK 1156	FCD0103
CK 1159	FCD0101/1
CK 1163	FCS0101/2
CK 1165	FCS0120/3
CK 1166	FCD0189
CK 1177	FCD0159
CK 1180	FCD0105
CK 1181	FCD0129/1
CK 1183	FCD0122
CK 1186	FCD0180
CK 1190	FCD0107
CK 1191	FCD0106
CK 1193	FCD0140
CK 1194	FCD0112
CK 1196	FCD0236/1
CK 1206	FCD0137
CK 1210	FCS0142/3
CK 1218	FCS0675/2
CK 1219	FCS0675/3
CK 1220	FCD0143/1
CK 1221	FCD0182
CK 1222	FCD0110/1
CK 1224	FCD0171
CK 1229	FCD0181/1
CK 1230	FCS0142/2
CK 1234	FCD0442/1
CK 1248	FCD0430
CK 1250	FCD0171/1
CK 1252	FCD0450
CK 1253	FCD0122/1
CK 1257	FCD0235/1
CK 1264	FCD0238/1
CK 1265	FCD0239/1
CK 1266	FCD0234
CK 1285	FCD0235
CK 1287	FCD0240
CK 1289	FCD0234/1
CK 1291	FCS0132/2
CK 1292	FCD0157

EBC	Ferodo
CK 1293	FCD0186
CK 1294	FCD0133/1
CK 1307	FCD0139/1
CK 2207	FCS0231/2
CK 2209	FCD0218/1
CK 2223	FCD0266
CK 2230	FCD0202
CK 2236	FCS0218/2
CK 2238	FCD0231
CK 2240	FCS0223/3
CK 2242	FCD0209
CK 2244	FCD0225
CK 2245	FCD0218
CK 2250	FCD0212/1
CK 2255	FCD0216/1
CK 2261	FCD0206
CK 2267	FCS0212/2
CK 2273	FCD0213
CK 2274	FCD0260
CK 2276	FCD0315
CK 2281	FCD0212
CK 2283	FCD0204
CK 2287	FCD0217
CK 2291	FCD0255
CK 2295	FCD0240/1
CK 2297	FCD0270
CK 2299	FCD0315/1
CK 2300	FCD0208/1
CK 2302	FCD0220
CK 2304	FCD0228
CK 2305	FCD0220/1
CK 2308	FCD0232
CK 2309	FCD0215
CK 2310	FCD0277
CK 2311	FCS0218/3
CK 2312	FCD0263
CK 2315	FCD0241
CK 2316	FCD0242
CK 2318	FCD0244
CK 2321	FCS0246/3
CK 2327	FCS0247/2
CK 2331	FCS0247/3
CK 2332	FCS0249/2
CK 2335	FCD0248
CK 2336	FCD0251
CK 2337	FCS0251/2
CK 2339	FCD0251/1
CK 2347	FCD0280
CK 2348	FCD0205
CK 2349	FCD0281
CK 2351	FCD0233
CK 2354	FCD0366
CK 2355	FCD0375
CK 2356	FCD0331
CK 2358	FCS0233/3

EBC	Ferodo
CK 3306	FCD0323/1
CK 3312	FCS0326/3
CK 3316	FCD0326/1
CK 3318	FCS0308/3
CK 3319	FCS0322/3
CK 3321	FCS0326/2
CK 3324	FCD0313
CK 3326	FCD0326
CK 3330	FCD0305
CK 3333	FCS0334/3
CK 3334	FCD0330/1
CK 3335	FCD0310/1
CK 3337	FCD0327/1
CK 3338	FCD0324/1
CK 3340	FCS0308/2
CK 3343	FCD0333/1
CK 3345	FCD0313/1
CK 3346	FCS0320/2
CK 3347	FCD0320
CK 3348	FCD0317
CK 3349	FCD0306/1
CK 3349/R	FCD0351
CK 3351	FCD0306
CK 3353	FCD0307/1
CK 3357	FCS0321/3
CK 3359	FCD0349/1
CK 3364	FCD0371
CK 3366	FCD0367
CK 3367	FCD0309
CK 3372	FCD0359
CK 3373	FCD0318
CK 3375	FCD0318/1
CK 3377	FCD0362
CK 3378	FCD0355
CK 3381	FCD0309/1
CK 3382	FCS0342/2
CK 3384	FCD0334
CK 3385	FCD0352
CK 3387	FCD0304
CK 3388	FCD0328/1
CK 3389	FCD0316/1
CK 3390	FCD0364
CK 3400	FCS0151/3
CK 3401	FCD0184
CK 3402	FCD0146
CK 3403	FCD0147
CK 3428	FCD0366/1
CK 3430	FCD0368/1
CK 3432	FCD0370
CK 3433	FCD0370/1
CK 3435	FCD0374
CK 4419	FCS0425/3
CK 4421	FCS0406/3
CK 4424	FCD0436
CK 4425	FCD0426

CLUTCHES X-REF

COMPETITORS TO FERODO

EBC	Ferodo
CK 4434	FCD0454/1
CK 4438	FCS0420/3
CK 4442	FCD0409/1
CK 4443	FCD0406/1
CK 4452	FCD0417
CK 4457	FCS0419/2
CK 4459	FCS0420/2
CK 4463	FCD0424/1
CK 4465	FCD0424
CK 4468	FCD0404
CK 4469	FCD0422
CK 4473	FCD0435
CK 4475	FCD0448
CK 4477	FCD0405
CK 4478	FCD0411
CK 4482	FCD0414
CK 4484	FCD0421/1
CK 4485	FCD0423/1
CK 4486	FCS0409/3
CK 4488	FCD0428
CK 4489	FCD0428/1
CK 4493	FCD0441
CK 4494	FCD0441/1
CK 4503	FCS0267/3
CK 4505	FCD0284
CK 4508	FCD0287
CK 4509	FCD0418
CK 4511	FCD0425
CK 5594	FCD0566
CK 6601	FCS0586/3
CK 6604	FCS0503/3
CK 6605	FCD0503/1
CK 6606 MP	FCD0584
CK 6610	FCD0573
CK 6610 MP	FCS0573/2
CK 6612	FCD0617
CK 6613	FCS0662/2
CK 6613 MP	FCD0671
CK 6614 MP	FCD0531
CK 6615	FCD0554
CK 6618 MP	FCD0637
CK 6619	FCD0646
CK 6621 MP	FCD0592
CK 6622	FCD0577
CK 6622 MP	FCS0577/2
CK 6628	FCS0538/2
CK 6630 MP	FCD0662
CK 6680	FCS0502/3
CK 6680 R	FCS0504/3
CK 6681 R	FCS0501/3
CK1167	FCD0119
CK1228	FCD0138
CK2285	FCD0219
CK2317	FCD0243
CK2350	FCD0247

EBC	Ferodo
CK2368	FCD1201
CK3417	FCD0337
CK4409	FCD0116
CK4455	FCD0416
CK5588	FCD0736
CK5594	FCD0661
CK5605	FCD0641
CK5608	FCD0733
CK5610	FCD0705
CK5611	FCD0501
CK5624	FCD0734
CSK 01	FSS0111
CSK 02	FSS0406
CSK 03	FSS0112
CSK 04	FSS0303
CSK 06	FSS0304
CSK 07	FSS0305
CSK 08	FSS0113
CSK 09	FSS0114
CSK 11	FSS0115
CSK 12	FSS0306
CSK 13	FSS0116
CSK 14	FSS0307
CSK 15	FSS0408
CSK 16	FSS0308
CSK 17	FSS0204
CSK 18	FSS0409
CSK 19	FSS0205
CSK 20	FSS0410
CSK 21	FSS0117
CSK 22	FSS0206
CSK 23	FSS0118
CSK 24	FSS0125
CSK 25	FSS0309
CSK 26	FSS0207
CSK 27	FSS0119
CSK 28	FSS0120
CSK 29	FSS0208
CSK 31	FSS0209
CSK 32	FSS0310
CSK 34	FSS0320
CSK 35	FSS0411
CSK 36	FSS0210
CSK 37	FSS0212
CSK 40	FSS0412
CSK 42	FSS0413
CSK 44	FSS0414
CSK 46	FSS0313
CSK 49	FSS0315
CSK 52	FSS0415
CSK 53	FSS0316
CSK 54	FSS0123
CSK 55	FSS0317
CSK 56	FSS0318
CSK 58	FSS0211

EBC	Ferodo
CSK 59	FSS0127
CSK 60	FSS0501
CSK 63	FSS0215
CSK 65	FSS0213
CSK 66	FSS0319
CSK 67	FSS0417
CSK 69	FSS0128
CSK 70	FSS0502
CSK 71	FSS0508
CSK 72	FSS0505
CSK 74	FSS0510
CSK 75	FSS0514
CSK 77	FSS0504
CSK 78	FSS0516
CSK 79	FSS0520
CSK 81	FSS0506
CSK 82	FSS0519
CSK 83	FSS0521
CSK 88	FSS0518
CSK 92	FSS0131
CSK 93	FSS0509
CSK 97	FSS0513
CSK 99	FSS0507

NEWFREN	Ferodo
CK2363	FCD0294
CK6608	FCD0634
F1167	FCD0721
F1167 AC	FCS0721/2
F1168	FCD0722
F1168 AC	FCS0722/2
F1169	FCD0723
F1169 AC	FCS0723/2
F1170	FCD0724
F1170 AC	FCS0724/2
F1171	FCD0725
F1171 AC	FCS0725/2
F1172	FCD0683
F1173	FCD0500
F1174	FCD0600
F1175	FCD0508
F1176	FCD0514
F1177	FCD0602
F1178	FCD0518
F1178 AC	FCS0518/2
F1178 R	FCD0518/1
F1178 SR	FCS0518/3
F1179	FCD0507
F1179 AC	FCS0507/2
F1180	FCD0607
F1180 AC	FCS0607/2
F1184	FCD0536
F1185	FCD0542
F1186	FCD0623
F1186 AC	FCS0623/2

CLUTCHES X-REF

COMPETITORS TO FERODO

NEWFREN	Ferodo
F1187	FCD0506
F1188	FCD0509
F1188 R	FCD0509/1
F1189	FCD0510
F1189 AC	FCS0510/2
F1191	FCD0554
F1191 AC	FCS0554/2
F1192	FCD0578
F1192 AC	FCS0578/2
F1193	FCD0511
F1194	FCD0611
F1195	FCD0515
F1196	FCD0535
F1199	FCD0604
F1200	FCD0579
F1317	FCD1318
F1317 AC	FCS1318/2
F1317 R	FCD1318/1
F1317 SR	FCS1318/3
F1325	FCD1336
F1325 AC	FCS1336/2
F1325 R	FCD1336/1
F1325 SR	FCS1336/3
F1326	FCD1317
F1326 AC	FCS1317/2
F1326 R	FCD1317/1
F1326 SR	FCS1317/3
F1338 R	FCD1320/1
F1338 SR	FCS1320/3
F1339 R	FCD1321/1
F1339 SR	FCS1321/3
F1340	FCD1322
F1340 AC	FCS1322/2
F1340 R	FCD1322/1
F1340 SR	FCS1322/3
F1341	FCD1323
F1341 AC	FCS1323/2
F1401	FCD0612
F1402	FCD0543
F1403	FCD0571
F1404	FCD0513
F1408	FCD0516
F1408 R	FCD0516/1
F1409	FCD0580
F1409 R	FCD0580/1
F1411	FCD0557
F1411 AC	FCS0557/2
F1411 R	FCD0557/1
F1411 SR	FCS0557/3
F1412	FCD0581
F1412 R	FCD0581/1
F1414	FCD0538
F1414 AC	FCS0538/2
F1414 R	FCD0538/1
F1414 SR	FCS0538/3

NEWFREN	Ferodo
F1416	FCD0544
F1417	FCD0633
F1417 R	FCD0633/1
F1418 R	FCD0558/1
F1418 SR	FCS0558/3
F1419	FCD0682
F1419 R	FCD0682/1
F1420	FCD0615
F1420 AC	FCS0615/2
F1420 R	FCD0615/1
F1420 SR	FCS0615/3
F1421	FCD0523
F1421 AC	FCS0523/2
F1421 R	FCD0523/1
F1421 SR	FCS0523/3
F1422 AC	FCS0524/2
F1423 AC	FCS0534/2
F1424 AC	FCS0582/2
F1425 AC	FCS0605/2
F1426 AC	FCS0616/2
F1427 AC	FCS0626/2
F1428 AC	FCS0649/2
F1429 AC	FCS0659/2
F1430 AC	FCS0663/2
F1431 AC	FCS0667/2
F1432 AC	FCS0651/2
F1433 AC	FCS0583/2
F1434	FCD0684
F1434 AC	FCS0684/2
F1434 R	FCD0684/1
F1434 SR	FCS0684/3
F1435 R	FCD0685/1
F1436 R	FCD0739/1
F1436 SR	FCS0739/3
F1438	FCD0741
F1438 R	FCD0741/1
F1439 R	FCD0742/1
F1440 AC	FCS0743/2
F1441 AC	FCS0744/2
F1442 AC	FCS0745/2
F1443 AC	FCS0746/2
F1444 AC	FCS0747/2
F1445 AC	FCS0748/2
F1446 AC	FCS0749/2
F1447 R	FCD0690/1
F1447 SR	FCS0690/3
F1448 R	FCD0691/1
F1448 SR	FCS0691/3
F1449	FCD0692
F1449 AC	FCS0692/2
F1449 R	FCD0692/1
F1449 SR	FCS0692/3
F1450 R	FCD0693/1
F1450 SR	FCS0693/3
F1451 R	FCD0694/1

NEWFREN	Ferodo
F1452 R	FCD0695/1
F1453	FCD0696
F1453 AC	FCS0696/2
F1453 R	FCD0696/1
F1453 SR	FCS0696/3
F1454	FCD0697
F1454 R	FCD0697/1
F1455	FCD0698
F1455 AC	FCS0698/2
F1455 R	FCD0698/1
F1455 SR	FCS0698/3
F1456	FCD0519
F1456 AC	FCS0519/2
F1457	FCD0606
F1457 AC	FCS0606/2
F1458	FCD0634
F1458 AC	FCS0634/2
F1459	FCD0528
F1459 AC	FCS0528/2
F1460	FCD0584
F1460 AC	FCS0584/2
F1462	FCD0699
F1462 R	FCD0699/1
F1463	FCD1319
F1463 AC	FCS1319/2
F1463 R	FCD1319/1
F1463 SR	FCS1319/3
F1464	FCD1335
F1464 R	FCD1335/1
F1465	FCD1334
F1465 AC	FCS1334/2
F1465 R	FCD1334/1
F1465 SR	FCS1334/3
F1466 R	FCD0750/1
F1466 SR	FCS0750/3
F1467 R	FCD0751/1
F1467 SR	FCS0751/3
F1468 R	FCD0752/1
F1468 SR	FCS0752/3
F1469	FCD0753
F1469 AC	FCS0753/2
F1470 R	FCD0782/1
F1470 SR	FCS0782/3
F1472	FCD0733
F1472 R	FCD0733/1
F1473	FCD0545
F1473 AC	FCS0545/2
F1474	FCD0645
F1475	FCD0585
F1475 AC	FCS0585/2
F1475 R	FCD0585/1
F1475 SR	FCS0585/3
F1476	FCD0734
F1477	FCD0735
F1477 R	FCD0735/1

CLUTCHES X-REF

COMPETITORS TO FERODO

NEWFREN	Ferodo
F1478	FCD0736
F1478 R	FCD0736/1
F1479	FCD0732
F1479 R	FCD0732/1
F1480	FCD0728
F1480 AC	FCS0728/2
F1480 R	FCD0728/1
F1480 SR	FCS0728/3
F1481	FCD0658
F1482	FCD0560
F1483 R	FCD0729/1
F1483 SR	FCS0729/3
F1484 R	FCD0727/1
F1484 SR	FCS0727/3
F1485 R	FCD0731/1
F1485 SR	FCS0731/3
F1486 R	FCD0730/1
F1486 SR	FCS0730/3
F1487	FCD0737
F1487 R	FCD0737/1
F1488	FCD0738
F1489	FCD0720
F1489 AC	FCS0720/2
F1490	FCD0617
F1491	FCD0627
F1492	FCD0657
F1493	FCD0540
F1494	FCD0652
F1495	FCD0529
F1496	FCD0641
F1496 AC	FCS0641/2
F1496 R	FCD0641/1
F1496 SR	FCS0641/3
F1497	FCD0653
F1498	FCD0586
F1498 AC	FCS0586/2
F1498 R	FCD0586/1
F1498 SR	FCS0586/3
F1499	FCD0688
F1499 AC	FCS0688/2
F1499 R	FCD0688/1
F1499 SR	FCS0688/3
F1501 R	FCD0503/1
F1501 SR	FCS0503/3
F1502 R	FCD0501/1
F1502 SR	FCS0501/3
F1503 R	FCD0502/1
F1503 SR	FCS0502/3
F1504 R	FCD0504/1
F1504 SR	FCS0504/3
F1505 R	FCD0505/1
F1505 SR	FCS0505/3
F1506 R	FCD0654/1
F1506 SR	FCS0654/3
F1507 R	FCD0673/1

NEWFREN	Ferodo
F1507 SR	FCS0673/3
F1509 R	FCD0707/1
F1509 SR	FCS0707/3
F1511	FCD0705
F1511 AC	FCS0705/2
F1513 R	FCD0709/1
F1513 SR	FCS0709/3
F1514 R	FCD0710/1
F1514 SR	FCS0710/3
F1515 R	FCD0711/1
F1515 SR	FCS0711/3
F1516 R	FCD0712/1
F1516 SR	FCS0712/3
F1517 R	FCD0713/1
F1517 SR	FCS0713/3
F1518	FCD0689
F1518 R	FCD0689/1
F1519	FCD0547
F1520	FCD0618
F1521	FCD0635
F1522	FCD0587
F1523	FCD0719
F1523 AC	FCS0719/2
F1524	FCD0541
F1525	FCD0628
F1525 AC	FCS0628/2
F1526	FCD0530
F1526 AC	FCS0530/2
F1527	FCD0572
F1528	FCD0548
F1528 AC	FCS0548/2
F1529	FCD0636
F1529 AC	FCS0636/2
F1530	FCD0619
F1530 R	FCD0619/1
F1531	FCD0642
F1532	FCD0573
F1532 AC	FCS0573/2
F1533	FCD0588
F1533 R	FCD0588/1
F1534	FCD0715
F1534 AC	FCS0715/2
F1535	FCD0717
F1535 AC	FCS0717/2
F1537	FCD0648
F1538	FCD0718
F1538 AC	FCS0718/2
F1539	FCD0531
F1540	FCD0608
F1540 AC	FCS0608/2
F1540 R	FCD0608/1
F1540 SR	FCS0608/3
F1541	FCD0643
F1541 AC	FCS0643/2
F1542	FCD0564

NEWFREN	Ferodo
F1543	FCD0574
F1543 R	FCD0574/1
F1544	FCD0549
F1545	FCD0672
F1545 AC	FCS0672/2
F1546	FCD0655
F1547	FCD0589
F1549	FCD0532
F1553	FCD0660
F1560	FCD0664
F1561 R	FCD0561/1
F1561 SR	FCS0561/3
F1562	FCD0661
F1562 AC	FCS0661/2
F1565	FCD0665
F1565 AC	FCS0665/2
F1565 R	FCD0665/1
F1565 SR	FCS0665/3
F1566	FCD0620
F1566 AC	FCS0620/2
F1567	FCD0568
F1567 AC	FCS0568/2
F1568	FCD0662
F1568 AC	FCS0662/2
F1569	FCD0671
F1569 AC	FCS0671/2
F1570	FCD0669
F1570 AC	FCS0669/2
F1571	FCD0576
F1571 AC	FCS0576/2
F1574	FCD0567
F1575/3	FCD0591
F1575/5	FCD0656
F1576/2	FCD0566
F1576/3	FCD0666
F1577	FCD0630
F1578	FCD0670
F1579	FCD0701
F1579 AC	FCS0701/2
F1580	FCD0637
F1581	FCD0646
F1582	FCD0702
F1582 AC	FCS0702/2
F1583	FCD0703
F1583 AC	FCS0703/2
F1584	FCD0592
F1584 R	FCD0592/1
F1585	FCD0577
F1585 AC	FCS0577/2
F1586	FCD0552
F1587 R	FCD0714/1
F1587 SR	FCS0714/3
F1589	FCD0621
F1590	FCD0614
F1590 R	FCD0614/1

CLUTCHES X-REF

COMPETITORS TO FERODO

NEWFREN	Ferodo
F1591	FCD0593
F1591 AC	FCS0593/2
F1591 R	FCD0593/1
F1591 SR	FCS0593/3
F1592	FCD0610
F1593	FCD0594
F1593 AC	FCS0594/2
F1593 R	FCD0594/1
F1593 SR	FCS0594/3
F1595	FCD0553
F1596	FCD0622
F1597	FCD0613
F1598	FCD0533
F1599	FCD0525
F1600	FCD0152
F1600 R	FCD0152/1
F1601	FCD0161
F1602	FCD0130
F1603	FCD0165
F1604	FCD0175
F1604 R	FCD0175/1
F1605	FCD0117
F1606	FCD0115
F1606 R	FCD0115/1
F1607	FCD0114
F1608	FCD0191
F1609	FCD0153
F1609 R	FCD0153/1
F1610	FCD0166
F1610 R	FCD0166/1
F1612	FCD0176
F1613	FCD0192
F1615	FCD0102
F1615 R	FCD0102/1
F1616	FCD0190
F1616 R	FCD0190/1
F1617	FCD0150
F1620	FCD0112
F1620 R	FCD0112/1
F1622	FCD0122
F1622 R	FCD0122/1
F1623	FCD0101
F1623 AC	FCS0101/2
F1623 R	FCD0101/1
F1623 SR	FCS0101/3
F1625	FCD0119
F1625 R	FCD0119/1
F1626	FCD0154
F1627	FCD0167
F1627 R	FCD0167/1
F1628	FCD0108
F1628 R	FCD0108/1
F1629	FCD0111
F1629 R	FCD0111/1
F1630	FCD0132

NEWFREN	Ferodo
F1630 AC	FCS0132/2
F1630 R	FCD0132/1
F1630 SR	FCS0132/3
F1631	FCD0120
F1631 AC	FCS0120/2
F1631 R	FCD0120/1
F1631 SR	FCS0120/3
F1633	FCD0126
F1633 AC	FCS0126/2
F1633 R	FCD0126/1
F1633 SR	FCS0126/3
F1634	FCD0136
F1634 AC	FCS0136/2
F1634 R	FCD0136/1
F1634 SR	FCS0136/3
F1637	FCD0118
F1637 R	FCD0118/1
F1638	FCD0125
F1638 R	FCD0125/1
F1639	FCD0107
F1640	FCD0113
F1641	FCD0109
F1642	FCD0124
F1642 R	FCD0124/1
F1643	FCD0127
F1643 R	FCD0127/1
F1644	FCD0110
F1644 R	FCD0110/1
F1645	FCD0155
F1645 R	FCD0155/1
F1646	FCD0168
F1646 R	FCD0168/1
F1647	FCD0178
F1649	FCD0189
F1650	FCD0129
F1650 R	FCD0129/1
F1651	FCD0188
F1652	FCD0179
F1653	FCD0103
F1654	FCD0104
F1655	FCD0105
F1655 R	FCD0105/1
F1656	FCD0106
F1656 R	FCD0106/1
F1657	FCD0193
F1658	FCD0194
F1658 AC	FCS0194/2
F1658 R	FCD0194/1
F1658 SR	FCS0194/3
F1661	FCD0123
F1661 R	FCD0123/1
F1662	FCD0157
F1662 R	FCD0157/1
F1665	FCD0133
F1665 AC	FCS0133/2

NEWFREN	Ferodo
F1665 R	FCD0133/1
F1665 SR	FCS0133/3
F1667	FCD0139
F1667 R	FCD0139/1
F1668	FCD0140
F1672	FCD0138
F1672 R	FCD0138/1
F1674	FCD0134
F1675	FCD0162
F1675 R	FCD0162/1
F1676	FCD0135
F1676 AC	FCS0135/2
F1676 R	FCD0135/1
F1676 SR	FCS0135/3
F1677	FCD0159
F1677 R	FCD0159/1
F1678	FCD0180
F1679	FCD0160
F1679 R	FCD0160/1
F1680	FCD0170
F1680 R	FCD0170/1
F1681	FCD0137
F1683	FCD0181
F1683 R	FCD0181/1
F1684	FCD0142
F1684 AC	FCS0142/2
F1684 R	FCD0142/1
F1684 SR	FCS0142/3
F1685	FCD0675
F1685 AC	FCS0675/2
F1685 R	FCD0675/1
F1685 SR	FCS0675/3
F1686	FCD0143
F1686 R	FCD0143/1
F1687	FCD0182
F1693	FCD0171
F1693 R	FCD0171/1
F1698	FCD0183
F1698 R	FCD0183/1
F1700	FCD0432
F1700 R	FCD0432/1
F1701	FCD0430
F1701 R	FCD0430/1
F1702	FCD0442
F1702 R	FCD0442/1
F1703	FCD0431
F1703 R	FCD0431/1
F1704	FCD0450
F1704 R	FCD0450/1
F1705	FCD0455
F1705 R	FCD0455/1
F1706	FCD0456
F1706 AC	FCS0456/2
F1706 R	FCD0456/1
F1706 SR	FCS0456/3

CLUTCHES X-REF

COMPETITORS TO FERODO

NEWFREN	Ferodo
F1708	FCD0457
F1708 AC	FCS0457/2
F1708 R	FCD0457/1
F1708 SR	FCS0457/3
F1709	FCD0458
F1709 R	FCD0458/1
F1710	FCD0459
F1711	FCD0460
F1711 R	FCD0460/1
F1712	FCD0403
F1720	FCD0415
F1720 AC	FCS0415/2
F1720 R	FCD0415/1
F1720 SR	FCS0415/3
F1721	FCD0451
F1721 R	FCD0451/1
F1726	FCD0418
F1728	FCD0461
F1728 R	FCD0461/1
F1729	FCD0462
F1729 AC	FCS0462/2
F1732	FCD0425
F1732 AC	FCS0425/2
F1732 R	FCD0425/1
F1732 SR	FCS0425/3
F1734	FCD0433
F1734 R	FCD0433/1
F1735	FCD0444
F1736	FCD0416
F1737	FCD0434
F1738	FCD0412
F1739	FCD0410
F1741	FCD0424
F1741 R	FCD0424/1
F1742	FCD0423
F1742 R	FCD0423/1
F1743	FCD0445
F1743 R	FCD0445/1
F1744	FCD0421
F1744 R	FCD0421/1
F1746	FCD0419
F1746 AC	FCS0419/2
F1747	FCD0417
F1747 R	FCD0417/1
F1748	FCD0414
F1748 R	FCD0414/1
F1750	FCD0411
F1750 AC	FCS0411/2
F1751	FCD0408
F1751 R	FCD0408/1
F1752	FCD0405
F1752 AC	FCS0405/2
F1752 R	FCD0405/1
F1752 SR	FCS0405/3
F1753	FCD0435

NEWFREN	Ferodo
F1755	FCD0446
F1755 R	FCD0446/1
F1756	FCD0404
F1756 R	FCD0404/1
F1757	FCD0420
F1757 AC	FCS0420/2
F1757 R	FCD0420/1
F1757 SR	FCS0420/3
F1759	FCD0454
F1759 AC	FCS0454/2
F1759 R	FCD0454/1
F1759 SR	FCS0454/3
F1760	FCD0436
F1761	FCD0447
F1761 R	FCD0447/1
F1762	FCD0406
F1762 AC	FCS0406/2
F1762 R	FCD0406/1
F1762 SR	FCS0406/3
F1763	FCD0407
F1764	FCD0422
F1764 AC	FCS0422/2
F1764 R	FCD0422/1
F1764 SR	FCS0422/3
F1767	FCD0437
F1770	FCD0116
F1770 R	FCD0116/1
F1771	FCD0402
F1771 R	FCD0402/1
F1772	FCD0409
F1772 AC	FCS0409/2
F1772 R	FCD0409/1
F1772 SR	FCS0409/3
F1773	FCD0413
F1775	FCD0426
F1775 R	FCD0426/1
F1777	FCD0438
F1777 R	FCD0438/1
F1781	FCD0427
F1781 R	FCD0427/1
F1786	FCD0448
F1786 R	FCD0448/1
F1792	FCD0428
F1792 AC	FCS0428/2
F1792 R	FCD0428/1
F1792 SR	FCS0428/3
F1794	FCD0429
F1794 AC	FCS0429/2
F1795	FCD0441
F1795 R	FCD0441/1
F1796	FCD0449
F1799	FCD0463
F1799 R	FCD0463/1
F1800	FCD0252
F1800 R	FCD0252/1

NEWFREN	Ferodo
F1801	FCD0267
F1801 AC	FCS0267/2
F1801 R	FCD0267/1
F1801 SR	FCS0267/3
F1803	FCD0279
F1804	FCD0284
F1805	FCD0287
F1805 R	FCD0287/1
F1806	FCD0286
F1806 R	FCD0286/1
F1811	FCD0285
F1811 R	FCD0285/1
F1816	FCD0227
F1817	FCD0226
F1817 R	FCD0226/1
F1819	FCD0268
F1820	FCD0213
F1820 R	FCD0213/1
F1821	FCD0211
F1822	FCD0280
F1822 R	FCD0280/1
F1823	FCD0210
F1825	FCD0254
F1826	FCD0205
F1828	FCD0281
F1830	FCD0233
F1830 AC	FCS0233/2
F1830 R	FCD0233/1
F1830 SR	FCS0233/3
F1831	FCD0208
F1831 R	FCD0208/1
F1832	FCD0255
F1832 R	FCD0255/1
F1836	FCD0212
F1836 AC	FCS0212/2
F1836 R	FCD0212/1
F1836 SR	FCS0212/3
F1837	FCD0218
F1837 AC	FCS0218/2
F1837 R	FCD0218/1
F1837 SR	FCS0218/3
F1838	FCD0223
F1838 AC	FCS0223/2
F1838 R	FCD0223/1
F1838 SR	FCS0223/3
F1840	FCD0230
F1840 R	FCD0230/1
F1842	FCD0216
F1842 R	FCD0216/1
F1843	FCD0207
F1844	FCD0256
F1844 R	FCD0256/1
F1845	FCD0228
F1845 R	FCD0228/1
F1846	FCD0270

CLUTCHES X-REF

COMPETITORS TO FERODO

NEWFREN	Ferodo
F1848	FCD0201
F1849	FCD0283
F1850	FCD0257
F1852	FCD0232
F1852 AC	FCS0232/2
F1852 R	FCD0232/1
F1852 SR	FCS0232/3
F1853	FCD0258
F1855	FCD0278
F1855 R	FCD0278/1
F1856	FCD0231
F1856 AC	FCS0231/2
F1856 R	FCD0231/1
F1856 SR	FCS0231/3
F1857	FCD0220
F1857 R	FCD0220/1
F1858	FCD0277
F1859	FCD0259
F1859 R	FCD0259/1
F1860	FCD0203
F1860 R	FCD0203/1
F1862	FCD0204
F1862 R	FCD0204/1
F1863	FCD0206
F1864	FCD0215
F1864 AC	FCS0215/2
F1864 R	FCD0215/1
F1864 SR	FCS0215/3
F1865	FCD0217
F1865 R	FCD0217/1
F1866	FCD0221
F1866 R	FCD0221/1
F1868	FCD0202
F1869	FCD0291
F1870	FCD0209
F1870 R	FCD0209/1
F1871	FCD0260
F1871 R	FCD0260/1
F1872	FCD0292
F1872 AC	FCS0292/2
F1873	FCD0229
F1873 R	FCD0229/1
F1875	FCD0219
F1875 R	FCD0219/1
F1876	FCD0261
F1876 R	FCD0261/1
F1877	FCD0293
F1877 R	FCD0293/1
F1880	FCD0294
F1880 R	FCD0294/1
F1882	FCD0271
F1882 R	FCD0271/1
F1889	FCD0678
F1889 R	FCD0678/1
F1890	FCD1233

NEWFREN	Ferodo
F1891	FCD0295
F1891 AC	FCS0295/2
F1891 R	FCD0295/1
F1891 SR	FCS0295/3
F1893	FCD0296
F1893 R	FCD0296/1
F1896	FCD0266
F1897	FCD0225
F1897 R	FCD0225/1
F1898	FCD0262
F1900	FCD0347
F1900 R	FCD0347/1
F1901	FCD0340
F1901 AC	FCS0340/2
F1901 R	FCD0340/1
F1901 SR	FCS0340/3
F1902	FCD0360
F1903	FCD0363
F1903 AC	FCS0363/2
F1903 R	FCD0363/1
F1903 SR	FCS0363/3
F1904	FCD0369
F1904 R	FCD0369/1
F1905	FCD0353
F1906	FCD0378
F1906 AC	FCS0378/2
F1906 R	FCD0378/1
F1906 SR	FCS0378/3
F1907	FCD0379
F1907 AC	FCS0379/2
F1907 R	FCD0379/1
F1907 SR	FCS0379/3
F1908	FCD0380
F1908 R	FCD0380/1
F1909	FCD0381
F1909 R	FCD0381/1
F1910	FCD0382
F1910 R	FCD0382/1
F1915	FCD0383
F1916	FCD0315
F1916 R	FCD0315/1
F1919	FCD0384
F1919 R	FCD0384/1
F1921	FCD0341
F1922	FCD0366
F1922 R	FCD0366/1
F1924	FCD0368
F1924 R	FCD0368/1
F1928	FCD0385
F1928 AC	FCS0385/2
F1928 R	FCD0385/1
F1928 SR	FCS0385/3
F1929	FCD0386
F1929 R	FCD0386/1
F1930	FCD0387

NEWFREN	Ferodo
F1930 AC	FCS0387/2
F1930 R	FCD0387/1
F1930 SR	FCS0387/3
F1931	FCD0388
F1931 R	FCD0388/1
F1932	FCD0389
F1932 AC	FCS0389/2
F1932 R	FCD0389/1
F1932 SR	FCS0389/3
F1934	FCD0370
F1934 R	FCD0370/1
F1935	FCD0325
F1935 R	FCD0325/1
F1936	FCD0361
F1937	FCD0374
F1938	FCD0323
F1938 R	FCD0323/1
F1939	FCD0391
F1939 AC	FCS0391/2
F1939 R	FCD0391/1
F1939 SR	FCS0391/3
F1940	FCD0321
F1940 AC	FCS0321/2
F1940 R	FCD0321/1
F1940 SR	FCS0321/3
F1941	FCD0319
F1942	FCD0318
F1942 R	FCD0318/1
F1943	FCD0328
F1943 R	FCD0328/1
F1944	FCD0316
F1944 R	FCD0316/1
F1946	FCD0352
F1947	FCD0342
F1947 AC	FCS0342/2
F1947 R	FCD0342/1
F1949	FCD0355
F1950	FCD0362
F1950 R	FCD0362/1
F1951	FCD0359
F1951 R	FCD0359/1
F1952	FCD0365
F1952 R	FCD0365/1
F1953	FCD0346
F1954	FCD0367
F1955	FCD0371
F1956	FCD0373
F1957	FCD0364
F1958	FCD0354
F1960	FCD0358
F1961	FCD0306
F1961 R	FCD0306/1
F1962	FCD0312
F1962 R	FCD0312/1
F1963	FCD0351

CLUTCHES X-REF

COMPETITORS TO FERODO

NEWFREN	Ferodo
F1964	FCD0320
F1964 AC	FCS0320/2
F1965	FCD0324
F1965 R	FCD0324/1
F1966	FCD0327
F1966 R	FCD0327/1
F1968	FCD0330
F1968 R	FCD0330/1
F1969	FCD0326
F1969 AC	FCS0326/2
F1969 R	FCD0326/1
F1969 SR	FCS0326/3
F1970	FCD0305
F1971	FCD0313
F1971 R	FCD0313/1
F1972	FCD0309
F1972 R	FCD0309/1
F1973	FCD0304
F1973 R	FCD0304/1
F1975	FCD0317
F1975 R	FCD0317/1
F1978	FCD0392
F1978 R	FCD0392/1
F1979	FCD0310
F1979 R	FCD0310/1
F1980	FCD0301
F1980 R	FCD0301/1
F1981	FCD0302
F1981 R	FCD0302/1
F1982	FCD0303
F1983	FCD0372
F1984	FCD0311
F1985	FCD0349
F1985 R	FCD0349/1
F1987	FCD0307
F1987 R	FCD0307/1
F1988	FCD0308
F1988 AC	FCS0308/2
F1988 R	FCD0308/1
F1988 SR	FCS0308/3
F1990	FCD0322
F1990 AC	FCS0322/2
F1990 R	FCD0322/1
F1990 SR	FCS0322/3
F1991	FCD0393
F1991 R	FCD0393/1
F1992	FCD0394
F1993	FCD0395
F1994	FCD0332
F1994 R	FCD0332/1
F1996	FCD0333
F1996 R	FCD0333/1
F1997	FCD0334
F1997 AC	FCS0334/2
F1997 R	FCD0334/1

NEWFREN	Ferodo
F1997 SR	FCS0334/3
F1998	FCD0335
F1998 R	FCD0335/1
F2602	FCD0151
F2602 AC	FCS0151/2
F2602 R	FCD0151/1
F2602 SR	FCS0151/3
F2609	FCD0131
F2609 R	FCD0131/1
F2623	FCD0196
F2623 R	FCD0196/1
F2631	FCD0197
F2632	FCD0198
F2633	FCD0199
F2633 R	FCD0199/1
F2635	FCD1101
F2636	FCD1102
F2636 R	FCD1102/1
F2637	FCD1103
F2637 AC	FCS1103/2
F2637 R	FCD1103/1
F2637 SR	FCS1103/3
F2638	FCD1104
F2638 R	FCD1104/1
F2639	FCD1105
F2639 AC	FCS1105/2
F2639 R	FCD1105/1
F2639 SR	FCS1105/3
F2640	FCD1106
F2640 R	FCD1106/1
F2644	FCD0184
F2644 R	FCD0184/1
F2647	FCD0144
F2647 R	FCD0144/1
F2654	FCD0145
F2654 R	FCD0145/1
F2655	FCD0146
F2655 R	FCD0146/1
F2666	FCD1107
F2666 AC	FCS1107/2
F2666 R	FCD1107/1
F2666 SR	FCS1107/3
F2676	FCD0147
F2676 R	FCD0147/1
F2678	FCD0149
F2679	FCD0186
F2679 R	FCD0186/1
F2680	FCD0174
F2680 R	FCD0174/1
F2683	FCD1108
F2683 R	FCD1108/1
F2684	FCD1109
F2684 R	FCD1109/1
F2686	FCD1111
F2686 R	FCD1111/1

NEWFREN	Ferodo
F2687	FCD1112
F2687 AC	FCS1112/2
F2687 R	FCD1112/1
F2687 SR	FCS1112/3
F2688	FCD1113
F2688 R	FCD1113/1
F2689	FCD1114
F2689 AC	FCS1114/2
F2689 R	FCD1114/1
F2689 SR	FCS1114/3
F2690	FCD1115
F2690 R	FCD1115/1
F2691	FCD1116
F2691 AC	FCS1116/2
F2691 R	FCD1116/1
F2691 SR	FCS1116/3
F2692	FCD1117
F2692 R	FCD1117/1
F2693 AC	FCS1118/2
F2693 SR	FCS1118/3
F2694	FCD1119
F2694 R	FCD1119/1
F2695	FCD1120
F2695 R	FCD1120/1
F2696	FCD1121
F2696 R	FCD1121/1
F2697	FCD1122
F2697 AC	FCS1122/2
F2697 R	FCD1122/1
F2697 SR	FCS1122/3
F2698	FCD1123
F2698 AC	FCS1123/2
F2698 R	FCD1123/1
F2698 SR	FCS1123/3
F2699	FCD1124
F2699 R	FCD1124/1
F2700	FCD0464
F2701	FCD0465
F2701 AC	FCS0465/2
F2701 R	FCD0465/1
F2701 SR	FCS0465/3
F2702	FCD0466
F2702 AC	FCS0466/2
F2702 R	FCD0466/1
F2702 SR	FCS0466/3
F2703	FCD0467
F2703 AC	FCS0467/2
F2703 R	FCD0467/1
F2703 SR	FCS0467/3
F2704	FCD0468
F2704 AC	FCS0468/2
F2704 R	FCD0468/1
F2704 SR	FCS0468/3
F2705	FCD0469
F2705 R	FCD0469/1

CLUTCHES X-REF

COMPETITORS TO FERODO

NEWFREN	Ferodo
F2706	FCD0470
F2706 R	FCD0470/1
F2707	FCD0471
F2707 AC	FCS0471/2
F2707 R	FCD0471/1
F2707 SR	FCS0471/3
F2708	FCD0472
F2708 R	FCD0472/1
F2709	FCD0473
F2710	FCD0474
F2710 R	FCD0474/1
F2711	FCD0475
F2712	FCD0476
F2712 R	FCD0476/1
F2713	FCD0477
F2713 R	FCD0477/1
F2714	FCD0478
F2714 R	FCD0478/1
F2715	FCD0479
F2715 AC	FCS0479/2
F2715 R	FCD0479/1
F2715 SR	FCS0479/3
F2716	FCD0480
F2716 AC	FCS0480/2
F2716 R	FCD0480/1
F2716 SR	FCS0480/3
F2717	FCD0481
F2717 R	FCD0481/1
F2718	FCD0482
F2718 AC	FCS0482/2
F2718 R	FCD0482/1
F2718 SR	FCS0482/3
F2719	FCD0483
F2719 R	FCD0483/1
F2720	FCD0484
F2720 R	FCD0484/1
F2721	FCD0485
F2721 R	FCD0485/1
F2722	FCD0486
F2722 R	FCD0486/1
F2723	FCD0487
F2723 AC	FCS0487/2
F2723 R	FCD0487/1
F2723 SR	FCS0487/3
F2724	FCD1324
F2724 R	FCD1324/1
F2724 SR	FCS1324/3
F2725	FCD1325
F2725 AC	FCS1325/2
F2725 R	FCD1325/1
F2725 SR	FCS1325/3
F2728	FCD0378
F2728 AC	FCS0378/2
F2728 R	FCD0378/1
F2728 SR	FCS0378/3

NEWFREN	Ferodo
F2805	FCD0222
F2805 R	FCD0222/1
F2809	FCD0236
F2809 R	FCD0236/1
F2810	FCD0237
F2810 R	FCD0237/1
F2811	FCD0235
F2811 R	FCD0235/1
F2812	FCD0238
F2812 R	FCD0238/1
F2813	FCD0239
F2813 AC	FCS0239/2
F2813 R	FCD0239/1
F2813 SR	FCS0239/3
F2814	FCD0234
F2814 R	FCD0234/1
F2815	FCD0240
F2815 AC	FCS0240/2
F2815 R	FCD0240/1
F2815 SR	FCS0240/3
F2817	FCD0241
F2817 R	FCD0241/1
F2820	FCD0242
F2821	FCD0243
F2821 AC	FCS0243/2
F2821 R	FCD0243/1
F2821 SR	FCS0243/3
F2823	FCD0244
F2823 R	FCD0244/1
F2827	FCD0263
F2827 R	FCD0263/1
F2828	FCD0297
F2830	FCD0245
F2836	FCD0246
F2836 AC	FCS0246/2
F2836 R	FCD0246/1
F2836 SR	FCS0246/3
F2842	FCD0275
F2842 R	FCD0275/1
F2843	FCD0247
F2843 AC	FCS0247/2
F2843 R	FCD0247/1
F2843 SR	FCS0247/3
F2844	FCD0249
F2844 AC	FCS0249/2
F2844 R	FCD0249/1
F2844 SR	FCS0249/3
F2845	FCD0248
F2845 AC	FCS0248/2
F2845 R	FCD0248/1
F2845 SR	FCS0248/3
F2846	FCD0251
F2846 AC	FCS0251/2
F2846 R	FCD0251/1
F2846 SR	FCS0251/3

NEWFREN	Ferodo
F2850	FCD0290
F2850 AC	FCS0290/2
F2850 R	FCD0290/1
F2850 SR	FCS0290/3
F2851	FCD0298
F2851 R	FCD0298/1
F2852	FCD0299
F2852 R	FCD0299/1
F2853	FCD1201
F2853 R	FCD1201/1
F2854	FCD1202
F2854 R	FCD1202/1
F2855	FCD1203
F2855 R	FCD1203/1
F2856	FCD1204
F2856 R	FCD1204/1
F2857	FCD1205
F2858	FCD1206
F2858 R	FCD1206/1
F2859	FCD1207
F2859 R	FCD1207/1
F2860	FCD1208
F2860 R	FCD1208/1
F2861	FCD1209
F2861 R	FCD1209/1
F2862	FCD1210
F2862 AC	FCS1210/2
F2863	FCD1211
F2863 R	FCD1211/1
F2864	FCD1212
F2864 R	FCD1212/1
F2865	FCD1213
F2865 R	FCD1213/1
F2866	FCD1214
F2866 R	FCD1214/1
F2867	FCD1215
F2867 R	FCD1215/1
F2868	FCD1216
F2868 R	FCD1216/1
F2869	FCD1217
F2869 R	FCD1217/1
F2870	FCD1218
F2870 R	FCD1218/1
F2871	FCD1219
F2871 R	FCD1219/1
F2872	FCD1220
F2872 AC	FCS1220/2
F2872 R	FCD1220/1
F2872 SR	FCS1220/3
F2873	FCD1221
F2873 R	FCD1221/1
F2874	FCD1222
F2874 AC	FCS1222/2
F2874 R	FCD1222/1
F2874 SR	FCS1222/3

CLUTCHES X-REF

COMPETITORS TO FERODO

NEWFREN	Ferodo
F2875	FCD1223
F2875 R	FCD1223/1
F2876	FCD1224
F2876 R	FCD1224/1
F2877	FCD1225
F2877 AC	FCS1225/2
F2877 R	FCD1225/1
F2877 SR	FCS1225/3
F2878	FCD1226
F2878 AC	FCS1226/2
F2878 R	FCD1226/1
F2878 SR	FCS1226/3
F2879	FCD1227
F2879 AC	FCS1227/2
F2879 R	FCD1227/1
F2879 SR	FCS1227/3
F2880	FCD1228
F2880 R	FCD1228/1
F2881	FCD1229
F2881 R	FCD1229/1
F2882	FCD1230
F2882 R	FCD1230/1
F2883	FCD1231
F2883 R	FCD1231/1
F2884 R	FCD1232/1
F2884 SR	FCS1232/3
F2885	FCD1234
F2885 AC	FCS1234/2
F2885 R	FCD1234/1
F2885 SR	FCS1234/3
F2887	FCD1326
F2887 AC	FCS1326/2
F2887 R	FCD1326/1
F2887 SR	FCS1326/3
F2888	FCD1327
F2888 R	FCD1327/1
F2889	FCD1328
F2889 AC	FCS1328/2
F2889 R	FCD1328/1
F2889 SR	FCS1328/3
F2890	FCD1329
F2890 AC	FCS1329/2
F2890 R	FCD1329/1
F2890 SR	FCS1329/3
F2891	FCD1330
F2891 R	FCD1330/1
F2892	FCD1331
F2892 AC	FCS1331/2
F2892 R	FCD1331/1
F2892 SR	FCS1331/3
F2904	FCD0331
F2904 R	FCD0331/1
F2905	FCD0336
F2905 R	FCD0336/1
F2914	FCD0337

NEWFREN	Ferodo
F2914 R	FCD0337/1
F2915	FCD0338
F2922	FCD0396
F2922 R	FCD0396/1
F2925	FCD0375
F2925 AC	FCS0375/2
F2925 R	FCD0375/1
F2925 SR	FCS0375/3
F2926	FCD0376
F2926 AC	FCS0376/2
F2926 R	FCD0376/1
F2926 SR	FCS0376/3
F2927	FCD0377
F2927 AC	FCS0377/2
F2927 R	FCD0377/1
F2927 SR	FCS0377/3
F2928	FCD0397
F2928 AC	FCS0397/2
F2929	FCD0390
F2930	FCD0398
F2930 R	FCD0398/1
F2931	FCD0399
F2931 AC	FCS0399/2
F2931 R	FCD0399/1
F2931 SR	FCS0399/3
F2932	FCD1301
F2932 AC	FCS1301/2
F2932 R	FCD1301/1
F2932 SR	FCS1301/3
F2933	FCD1302
F2933 AC	FCS1302/2
F2933 R	FCD1302/1
F2933 SR	FCS1302/3
F2934	FCD1303
F2934 R	FCD1303/1
F2935	FCD1304
F2935 R	FCD1304/1
F2936	FCD1305
F2936 R	FCD1305/1
F2937	FCD1306
F2937 R	FCD1306/1
F2938	FCD1307
F2939	FCD1308
F2939 R	FCD1308/1
F2940	FCD1309
F2940 R	FCD1309/1
F2941	FCD1310
F2941 R	FCD1310/1
F2942	FCD1311
F2942 R	FCD1311/1
F2943	FCD1312
F2943 R	FCD1312/1
F2944	FCD1313
F2944 R	FCD1313/1
F2945	FCD1314

NEWFREN	Ferodo
F2945 AC	FCS1314/2
F2945 R	FCD1314/1
F2945 SR	FCS1314/3
F2946	FCD1315
F2946 AC	FCS1315/2
F2946 R	FCD1315/1
F2946 SR	FCS1315/3
F3600	FCD1125
F3600 R	FCD1125/1
F3601	FCD1126
F3601 AC	FCS1126/2
F3602	FCD1127
F3602 R	FCD1127/1
F3603	FCD1128
F3603 R	FCD1128/1
F3604	FCD1129
F3604 R	FCD1129/1
F3605	FCD1332
F3605 AC	FCS1332/2
F3606	FCD1333
F3606 AC	FCS1333/2
F3606 R	FCD1333/1
F3606 SR	FCS1333/3
FC1330	FCC0521
FC1332	FCC0531
FC1333	FCC0522
FC1334	FCC0504
FC1335	FCC0101
FC1336	FCC0505
FC1340 R	FCC0520
FC1341	FCC0105
FC1343	FCC0109
FC1344	FCC0104
FC1345	FCC0108
FC1346	FCC0106
FC1347	FCC0516
FC1349	FCC0535
FC1350	FCC0527
FC1351	FCC0539
FC1352	FCC0107
FC1353	FCC0301
FC1355 R	FCC0541
FC1356	FCC0540
FC1357	FCC0506
FC1359	FCC0102
FC1360	FCC0511
FC1362	FCC0523
FC1363	FCC0507
FC1364	FCC0524
FC1365	FCC0544
FC1367	FCC0517
FC1368	FCC0545
FC1369	FCC0508
FC1370	FCC0537
FC1371	FCC0532

CLUTCHES X-REF

COMPETITORS TO FERODO

NEWFREN	Ferodo
FC1372	FCC0543
FC1373	FCC0547
FC1376	FCC0548
FC1377	FCC0549
FC1378	FCC0550
FC1382	FCC0556
FC1383	FCC0553
FC1384	FCC0554
FC1385	FCC0557
FC1386	FCC0558
FC1388	FCC0560
FC1390	FCC0563
FC1391	FCC0564
FC1392	FCC0565
FC1393	FCC0566
FC1394	FCC0567
FC1396	FCC0569
FCK345	FCG0108
FCK346	FCG0106
FCK347	FCG0516
FCK350	FCG0527
FCK351	FCG0539
FCK352	FCG0107
FCK354	FCG0538
FCK355 R	FCG0541
FCK356	FCG0540
FCK357	FCG0506
FCK360	FCG0511
FCK362	FCG0523
FCK363	FCG0507
FCK364	FCG0524
FCK365	FCG0544
FCK367	FCG0517
FCK368	FCG0545
FCK370	FCG0537
FCK371	FCG0532
FCK373	FCG0547
FCK374	FCG0553
FCK375	FCG0546
FCK377	FCG0549
FCK378	FCG0550
FCK379	FCG0551
FCK380	FCG0552
FCK382	FCG0556
FCK385	FCG0557
FCK386	FCG0558
FCK387	FCG0559
FCK390	FCG0563
FCK391	FCG0564
FCK392	FCG0565
FCK393	FCG0566
FCK394	FCG0567
FCK396	FCG0569
G0684	FCB0018
G0685	FCB0016

NEWFREN	Ferodo
G0686	FCB0006
G0687	FCB0023
G0688	FCB0014
G0689	FCB0008
G0690	FCB0020
G0691	FCB0010
G0693	FCB0013
G0694	FCB0004
G0695	FCB0024
G0697	FCB0009
G0698	FCB0025
G0699	FCB0028
G0700	FCB0022
G0701	FCB0005
G0703	FCB0012
G0704	FCB0007
G0705	FCB0019
G0706	FCB0021
G0707	FCB0017
G0708	FCB0011
G0711	FCB0029
G0714	FCB0030
G0715	FCB0031
G0718	FCB0036
G0719	FCB0044
G0720	FCB0045
G0721	FCB0046
MO051F	FSS0401
MO052F	FSS0201
MO053F	FSS0402
MO054F	FSS0101
MO056F	FSS0301
MO057F	FSS0403
MO058F	FSS0102
MO059F	FSS0103
MO060F	FSS0404
MO062F	FSS0105
MO063F	FSS0302
MO064F	FSS0202
MO065F	FSS0106
MO066F	FSS0107
MO067F	FSS0203
MO068F	FSS0108
MO069F	FSS0405
MO070F	FSS0109
MO071F	FSS0110
MO072F	FSS0111
MO073F	FSS0406
MO074F	FSS0112
MO075F	FSS0303
MO076F	FSS0304
MO077F	FSS0305
MO078F	FSS0113
MO079F	FSS0114
MO081F	FSS0115

NEWFREN	Ferodo
MO082F	FSS0306
MO083F	FSS0116
MO084F	FSS0307
MO085F	FSS0408
MO086F	FSS0308
MO087F	FSS0204
MO088F	FSS0409
MO089F	FSS0205
MO090F	FSS0410
MO091F	FSS0117
MO092F	FSS0206
MO093F	FSS0118
MO094F	FSS0125
MO095F	FSS0309
MO096F	FSS0207
MO097F	FSS0119
MO098F	FSS0120
MO099F	FSS0208
MO102F	FSS0209
MO103F	FSS0310
MO105F	FSS0320
MO106F	FSS0411
MO108F	FSS0210
MO109F	FSS0212
MO112F	FSS0412
MO115F	FSS0413
MO117F	FSS0414
MO118F	FSS0312
MO119F	FSS0313
MO122F	FSS0315
MO123F	FSS0122
MO124F	FSS0415
MO125F	FSS0316
MO127F	FSS0123
MO128F	FSS0317
MO129F	FSS0318
MO131F	FSS0211
MO132F	FSS0127
MO133F	FSS0501
MO138F	FSS0416
MO141F	FSS0215
MO142F	FSS0213
MO143F	FSS0319
MO147F	FSS0417
MO149F	FSS0418
MO151F	FSS0128
MO278F	FSS0522
MO279F	FSS0523
MO600F	FSS0502
MO601F	FSS0508
MO602F	FSS0505
MO604F	FSS0510
MO605F	FSS0514
MO606F	FSS0504
MO607F	FSS0516

NEWFREN	Ferodo
MO609F	FSS0520
MO610F	FSS0506
MO611F	FSS0519
MO612F	FSS0521
MO613F	FSS0518
MO616F	FSS0129
MO620F	FSS0130
MO624F	FSS0132
MO628F	FSS0131
MO630F	FSS0509
MO631F	FSS0513
MO632F	FSS0507
MO633F	FSS0214
MO635F	FSS0503
MO644F	FSS0216
MO646F	FSS0218
MO649F	FSS0217
MO664F	FSS0220
MO665F	FSS0219

OE BMW	Ferodo
21217697737	FCD0738

OEM - BMW	Ferodo
21 21 7 670 453	FCD0652
21 21 7 670 454	FCD0617

OEM - Kymco	Ferodo
22100-LEA7-E00	FCB0044
22300-LGE5-E00	FCC0563

OEM - Malaguti	Ferodo
42606500	FCB0031
43500300	FCC0557
603.337.00	FCB0005
72605600	FCC0107
73503300	FCC0511
935.001.00	FCC0539

OEM - Piaggio	Ferodo
289933	FCB0016
840270	FCC0557
8722515	FCC0557
CM1002015	FCC0522

OEM - Suzuki	Ferodo
21220-05H30	FCB0036
21220-20E50	FCB0046
21501-05H01-000	FCC0565
21501-05H41	FCC0565
21501-15F01-000	FCC0506
21501-20E60-000	FCC0548
21501-20EA0	FCC0548
21501-46G10	FCC0567

OEM - Yamaha	Ferodo
1B9-E6611-10	FCB0025
1B9-E6620-10	FCC0564
1XX-16611-03	FCB0025
34B-16620-00	FCC0560
36X-16321-00	FCD0254



RACING

SPECIAL CLUTCH KITS

DUCATI

APPLICATIONS

Frizioni a bagno d'Olio
Oil-bath clutch
Embrayage à bain d'huile
Ölbadkupplung
Embrague en bano de aceite

Frizioni a secco
Dry Clutches
Embrayage à sec
Traockenkupplung
Embrague seco



ISTRUZIONI / KEY TO TEST / ESPLICACIONES DES REFERENCES / ERLÄUTERUNGEN / INSTRUCCIONES

FCDxxxx serie dischi conduttori Frizione a secco / Frizione a bagno d'olio
 FCSxxxx serie dischi conduttori + condotti (ricambio per campana a 48 denti)
 KFCDxxxx kit campana frizione + serie dischi

IT

	nr pezzi	spessore	nr denti	descrizione	anima disco	materiale di attrito
A	x	xx	xx	disco conduttore	acciaio/alluminio	sinterizzato/organico
B	x	xx	xx	condotto piatto	acciaio	-
C	x	xx	xx	condotto bombato	acciaio	-

Spessore totale pacco dischi ... mm

Per una corretta sequenza di montaggio, prestare attenzione al verso della bombatura dei dischi condotti.

FCDxxxx set friction plates Dry clutch / Oil immersed clutch
 FCSxxxx set friction plates + plain plates (replacement part for 48 tooth housing)
 KFCDxxxx clutch basket + plate pack

EN

	nr of pcs	thickness	nr of teeth	description	plate core material	friction material
A	x	xx	xx	friction plate	steel/aluminium	sintered/organic
B	x	xx	xx	flat plain plate	steel	-
C	x	xx	xx	dished plain plate	steel	-

Total pack height ... mm

To ensure correct assembly, pay special attention to the dished back of the plain plates.

FCDxxxx jeux disques garnis Embrayage à sec/ Embrayage à bain d'huile
 FCSxxxx jeux disques garnis + lisses kit (pièce de rechange adaptable pour cloche à 48 dents)
 KFCDxxxx cloche embrayage + jeux disques

F

	Q. pieces	épaisseur	nr dents	description	support du disque	matériel de friction
A	x	xx	xx	disque conducteur	acier/alluminium	sinter/organique
B	x	xx	xx	disque plat	acier	-
C	x	xx	xx	disque bombé	acier	-

Epaisseur total du jeux des disques ... mm

Pour un montage correct faire attention au bon positionnement des disques lisses bombés.

FCDxxxx Satz kupplungscheiben Trockenkupplung / Ölbادهkupplung
 FCSxxxx Satz reib- + trennscheiben (Ersatzteil für 48-zähne gehäuse)
 KFCDxxxx kupplungsgehäuse + scheidensatz

D

	stück-zahl	stärke	zähne-zahl	beschreibung	kernmaterial	reibmaterial
A	x	xx	xx	reibscheibe	stahl/alluminium	sintermetall/organischer stoff
B	x	xx	xx	trennscheibe	stahl	-
C	x	xx	xx	frontscheibe	stahl	-

Gesamtstärke des satzes ... mm

Für die richtige montagerihenfolge passen sie auf die seite der frontscheibe auf.

FCDxxxx Juego de discos embrague Embrague en seco / Embrague en baño de aceite
 FCSxxxx Juego de discos embrague + separadores (Recambio campana 48 dientes)
 KFCDxxxx Kit campana + juego de discos

E

	nr piezas	espesor	nr dientes	descripcion	alma del disco	materiale del embrague
A	x	xx	xx	disco separador	acero/aluminio	sinterizado/organico
B	x	xx	xx	separador plano	acero	-
C	x	xx	xx	separador abombado	acero	-

Espesor total del paquete ... mm

Para una correcta secuencia de montaje, prestar atención a la forma abombada del disco intermedio.

23000

FERODO
RACING

VEICOLO / VEHICLE / VEHICULE / FAHRZEUG / VEHICULOS

Modello	CC	Dal	Al	Mat. serie std ⁽¹⁾	Serie conduttori std	Serie conduttori racing	Serie conduttori + condotti std	Serie conduttori + condotti racing	Campana completa (Upgrade 48 denti)
MONSTER 400	400	1995	1999	SINT-ORG	FCD0568-FCD0568/0		FCS0568/2-FCS0568/20		
MONSTER 400	400	2000	2008	ORG	FCD0665	FCD0665/1	FCS0665/2	FCS0665/3	
MONSTER 400 DARK IE	400	2005		ORG	FCD0665	FCD0665/1	FCS0665/2	FCS0665/3	
SUPERSPORT 400	400	1993	1997	SINT-ORG	FCD0568-FCD0568/0		FCS0568/2-FCS0568/20		
550 SUPERMONO	550	1992		SINT	FCD0620		FCS0620/2		
MONSTER 600	600	1993	1997	SINT-ORG	FCD0568-FCD0568/0		FCS0568/2-FCS0568/20		
MONSTER 600 DARK	600	1998		ORG	FCD0665	FCD0665/1	FCS0665/2	FCS0665/3	
MONSTER 600	600	1998	2001	ORG	FCD0665	FCD0665/1	FCS0665/2	FCS0665/3	
MONSTER 600 CITY - CITY DARK - DARK	600	1999		ORG	FCD0665	FCD0665/1	FCS0665/2	FCS0665/3	
SUPERSPORT 600	600	1991	1997	SINT-ORG	FCD0568-FCD0568/0		FCS0568/2-FCS0568/20		
MONSTER 620 IE	620	2002	2003	ORG	FCD0665	FCD0665/1	FCS0665/2	FCS0665/3	
MONSTER 620 (5 marce - single disk)	620	2004		ORG	FCD0665	FCD0665/1	FCS0665/2	FCS0665/3	
MONSTER 620 (6 marce)	620	2004		ORG	FCD0720		FCS0720/2		
MONSTER 620 DARK (single disk)	620	2005		ORG	FCD0720		FCS0720/2		
MONSTER 620	620	2005	2006	ORG	FCD0720		FCS0720/2		
MONSTER 620 DARK	620	2005	2006	ORG	FCD0720		FCS0720/2		
MULTISTRADA 620	620	2006		ORG	FCD0720		FCS0720/2		
MULTISTRADA 620 DARK	620	2006		ORG	FCD0720		FCS0720/2		
SPORT 620	620	2003		ORG	FCD0665	FCD0665/1	FCS0665/2	FCS0665/3	
MONSTER 695	695	2007	2012	ORG	FCD0720		FCS0720/2		
MONSTER 696	700	2008	2013	ORG	FCD0720		FCS0720/2		
748 BIPOSTO - SP	748	1995	2001	SINT-ORG	FCD0671-FCD0671/0		FCS0671/2-FCS0671/20		KFCD001*
748 SPS	748	1998	1999	SINT-ORG	FCD0671-FCD0671/0		FCS0671/2-FCS0671/20		KFCD001*
748 RACING (con antisaltellamento)	748	1998	1999	SINT-ORG	FCD0669-FCD0669/0		FCS0669/2-FCS0669/20		KFCD003*
748 RS (con antisaltellamento)	748	2000	2001	SINT-ORG	FCD0669-FCD0669/0		FCS0669/2-FCS0669/20		KFCD003*
748 S	748	2000	2002	SINT-ORG	FCD0671-FCD0671/0		FCS0671/2-FCS0671/20		KFCD001*
748 TESTA BASSA	748	2001		SINT-ORG	FCD0671-FCD0671/0		FCS0671/2-FCS0671/20		KFCD001*
748 BIPOSTO	748	2001		ORG	FCD0672		FCS0672/2		KFCD001*
748	748	2002		SINT-ORG	FCD0671-FCD0671/0		FCS0671/2-FCS0671/20		KFCD001*
749	748	2003	2006	ORG	FCD0672		FCS0672/2		KFCD001*
749 S	748	2003	2006	ORG	FCD0672		FCS0672/2		KFCD001*
749 DARK	748	2004	2006	ORG	FCD0672		FCS0672/2		KFCD001*
749 R	748	2004	2006	SINT-ORG	FCD0669-FCD0669/0		FCS0669/2-FCS0669/20		KFCD003*
MONSTER 750	750	1996	1997	SINT-ORG	FCD0568-FCD0568/0		FCS0568/2-FCS0568/20		
MONSTER 750	750	1998	2001	ORG	FCD0665	FCD0665/1	FCS0665/2	FCS0665/3	
MONSTER 750 CITY - CITY DARK	750	1999		ORG	FCD0665	FCD0665/1	FCS0665/2	FCS0665/3	
MONSTER 750 IE	750	2002		ORG	FCD0665	FCD0665/1	FCS0665/2	FCS0665/3	
SPORT 750	750	2000	2002	ORG	FCD0665	FCD0665/1	FCS0665/2	FCS0665/3	
SUPERSPORT 750	750	1991	1997	SINT-ORG	FCD0568-FCD0568/0		FCS0568/2-FCS0568/20		

* vedi pagina 23005
(1) materiale di serie in rosso

VEICOLO / VEHICLE / VEHICULE / FAHRZEUG / VEHICULOS

Modello	CC	Dal	Al	Mat. serie std ⁽¹⁾	Serie conduttori std	Serie conduttori racing	Serie conduttori + condotti std	Serie conduttori + condotti racing	Campana completa (Upgrade 48 denti)
SUPERSPORT 750	750	1999		ORG	FCD0665	FCD0665/1	FCS0665/2	FCS0665/3	
SUPERSPORT 750 IE	750	2000	2002	ORG	FCD0665	FCD0665/1	FCS0665/2	FCS0665/3	
MONSTER 795	795	2013		ORG	FCD0720		FCS0720/2		
HYPERMOTARD 796	800	2010	2012	ORG	FCD0720		FCS0720/2		
MONSTER 796	800	2011	2014	ORG	FCD0720		FCS0720/2		
MONSTER 800	800	2003	2004	ORG	FCD0665	FCD0665/1	FCS0665/2	FCS0665/3	
MONSTER 800 S2R DARK	800	2005	2006	ORG	FCD0720		FCS0720/2		
MONSTER 800 S2R	800	2005	2007	ORG	FCD0720		FCS0720/2		
SPORT 800	800	2003		ORG	FCD0665	FCD0665/1	FCS0665/2	FCS0665/3	
SUPERSPORT 800	800	2003	2005	ORG	FCD0665	FCD0665/1	FCS0665/2	FCS0665/3	
848	850	2008	2010			FCD0714/1		FCS0714/3	
EVO 848	850	2011	2012			FCD0714/1		FCS0714/3	
EVO CORSE SE 848	848	2012				FCD0714/1		FCS0714/3	
STREETFIGHTER 848	848	2012				FCD0714/1		FCS0714/3	
STREETFIGHTER 848 S	848	2012				FCD0714/1		FCS0714/3	
STREETFIGHTER 848	848	2013	2015			FCD0714/1		FCS0714/3	
SUPERBIKE 848 EVO CORSE SE-EVO-USA	848	2013				FCD0714/1		FCS0714/3	
SUPERBIKE 848 EVO CORSE-EVO-HAYDEN-USA	850	2008	2012			FCD0714/1		FCS0714/3	
851 all models	851	1991	1992	SINT-ORG	FCD0669-FCD0669/0		FCS0669/2-FCS0669/20		KFCD003*
888 all models	888	1993	1995	SINT-ORG	FCD0669-FCD0669/0		FCS0669/2-FCS0669/20		KFCD003*
888 SUPERBIKE STRADA	888	1994	1995	SINT-ORG	FCD0669-FCD0669/0		FCS0669/2-FCS0669/20		KFCD003*
PANIGALE 899 ABS - USA	899	2014				FCD0714/1		FCS0714/3	
MH 900	900	2001	2002	SINT-ORG	FCD0671-FCD0671/0		FCS0671/2-FCS0671/20		KFCD001*
MONSTER 900	900	1993	1999	SINT-ORG	FCD0671-FCD0671/0		FCS0671/2-FCS0671/20		KFCD001*
MONSTER 900 SPECIAL	900	1998		SINT-ORG	FCD0671-FCD0671/0		FCS0671/2-FCS0671/20		KFCD001*
MONSTER 900 CROMO	900	1998	1999	SINT-ORG	FCD0671-FCD0671/0		FCS0671/2-FCS0671/20		KFCD001*
MONSTER 900 CITY - CITY DARK	900	1999		SINT-ORG	FCD0671-FCD0671/0		FCS0671/2-FCS0671/20		KFCD001*
MONSTER 900 IE	900	2000	2001	SINT-ORG	FCD0671-FCD0671/0		FCS0671/2-FCS0671/20		KFCD001*
MONSTER 900 IE	900	2002		ORG	FCD0672		FCS0672/2		KFCD001*
SPORT 900	900	2002		SINT-ORG	FCD0671-FCD0671/0		FCS0671/2-FCS0671/20		KFCD001*
SUPERSPORT 900 SUPERLIGHT	900	1991	1997	SINT-ORG	FCD0671-FCD0671/0		FCS0671/2-FCS0671/20		KFCD001*
SUPERSPORT 900 F.E.	900	1998		SINT-ORG	FCD0671-FCD0671/0		FCS0671/2-FCS0671/20		KFCD001*
SUPERSPORT 900	900	1998	1999	SINT-ORG	FCD0671-FCD0671/0		FCS0671/2-FCS0671/20		KFCD001*
SUPERSPORT 900 IE	900	2000	2002	SINT-ORG	FCD0671-FCD0671/0		FCS0671/2-FCS0671/20		KFCD001*
907 IE	907	1990	1993	SINT-ORG	FCD0669-FCD0669/0		FCS0669/2-FCS0669/20		KFCD003*
916 SP	916	1994	1996	SINT	FCD0662		FCS0662/2		KFCD002*
916 BIPOSTO SENNA	916	1994	1998	SINT-ORG	FCD0671-FCD0671/0		FCS0671/2-FCS0671/20		KFCD001*
916 SPS - SPS I/II/III	996	1997	2000	SINT	FCD0662		FCS0662/2		KFCD002*
MONSTER 916 S4	916	2001	2002	SINT-ORG	FCD0671-FCD0671/0		FCS0671/2-FCS0671/20		KFCD001*

* vedi pagina 23005

(1) materiale di serie in rosso

VEICOLO / VEHICLE / VEHICULE / FAHRZEUG / VEHICULOS

Modello	CC	Dal	Al	Mat. serie std ⁽¹⁾	Serie conduttori std	Serie conduttori racing	Serie conduttori + condotti std	Serie conduttori + condotti racing	Campana completa (Upgrade 48 denti)
MONSTER 916 S4 FOGGY	916	2002		SINT-ORG	FCD0671-FCD0671/0		FCS0671/2-FCS0671/20		KFCD001*
RACING 916 (con antisaltellamento)	996	1997	1998	SINT-ORG	FCD0669-FCD0669/0		FCS0669/2-FCS0669/20		KFCD003*
ST4 916	916	1999	2001	SINT-ORG	FCD0671-FCD0671/0		FCS0671/2-FCS0671/20		KFCD001*
ST4 916	916	2002	2003	ORG	FCD0672		FCS0672/2		KFCD001*
ST2 944	944	1997	2001	SINT-ORG	FCD0671-FCD0671/0		FCS0671/2-FCS0671/20		KFCD001*
ST2 944	944	2002	2003	ORG	FCD0672		FCS0672/2		KFCD001*
996	996	1999	2001	SINT-ORG	FCD0671-FCD0671/0		FCS0671/2-FCS0671/20		KFCD001*
996 RS (con antisaltellamento)	996	2000	2001	SINT-ORG	FCD0669-FCD0669/0		FCS0669/2-FCS0669/20		KFCD003*
996 S	996	2001		SINT	FCD0662		FCS0662/2		KFCD002*
996 R	996	2001		SINT	FCD0662		FCS0662/2		KFCD002*
MONSTER 996 S4R	996	2003	2006	ORG	FCD0672		FCS0672/2		KFCD001*
ST4S 996	996	2001		SINT-ORG	FCD0671-FCD0671/0		FCS0671/2-FCS0671/20		KFCD001*
ST4S 996	996	2002	2004	ORG	FCD0672		FCS0672/2		KFCD001*
ST4S 996 ABS	996	2003	2004	ORG	FCD0672		FCS0672/2		KFCD001*
ST4S 996 ABS	996	2005				FCD0714/1		FCS0714/3	
ST4S 996	996	2005				FCD0714/1		FCS0714/3	
998 R	998	2002		SINT	FCD0662		FCS0662/2		KFCD002*
998 S BAYLISS - BOSTROM	998	2002		SINT-ORG	FCD0671-FCD0671/0		FCS0671/2-FCS0671/20		KFCD001*
998	998	2002	2003	SINT-ORG	FCD0671-FCD0671/0		FCS0671/2-FCS0671/20		KFCD001*
998 RS (con antisaltellamento)	998	2002	2003	SINT-ORG	FCD0669-FCD0669/0		FCS0669/2-FCS0669/20		KFCD003*
998 S FINAL EDITION	998	2004		ORG	FCD0672		FCS0672/2		KFCD001*
998 MATRIX	998	2004		SINT-ORG	FCD0671-FCD0671/0		FCS0671/2-FCS0671/20		KFCD001*
998 S	998	2005	2006	ORG	FCD0672		FCS0672/2		KFCD001*
999 S	998	2003	2004	SINT	FCD0662		FCS0662/2		KFCD002*
999 R	998	2003	2004	SINT	FCD0662		FCS0662/2		KFCD002*
999	998	2003	2006	ORG	FCD0672		FCS0672/2		KFCD001*
999 RS (con antisaltellamento)	998	2004	2005	SINT-ORG	FCD0669-FCD0669/0		FCS0669/2-FCS0669/20		KFCD003*
999 R	998	2005	2006	ORG	FCD0672		FCS0672/2		KFCD001*
DESMOSEDICI 1000 RR	1000	2008		SINT-ORG	FCD0669-FCD0669/0		FCS0669/2-FCS0669/20		KFCD003*
GT 1000	1000	2007	2010			FCD0714/1		FCS0714/3	
GT 1000 TOURING	1000	2009				FCD0714/1		FCS0714/3	
MONSTER 1000	1000	2003	2005	ORG	FCD0672		FCS0672/2		KFCD001*
MONSTER 1000 S	1000	2005		ORG	FCD0672		FCS0672/2		KFCD001*
MONSTER 1000 S4RS	1000	2006	2008	ORG	FCD0672		FCS0672/2		KFCD001*
MONSTER 1000 S2R	1000	2006	2008	ORG	FCD0672		FCS0672/2		KFCD001*
MONSTER 1000 S4R	1000	2007	2008	ORG	FCD0672		FCS0672/2		KFCD001*
MONSTER 1000 S4RS TRICOLORE	1000	2008		ORG	FCD0672		FCS0672/2		KFCD001*
MULTISTRADA 1000	1000	2003	2006	ORG	FCD0672		FCS0672/2		KFCD001*
MULTISTRADA 1000 DS	1000	2005		ORG	FCD0672		FCS0672/2		KFCD001*

* vedi pagina 23005

(1) materiale di serie in rosso

VEICOLO / VEHICLE / VEHICULE / FAHRZEUG / VEHICULOS

Modello	CC	Dal	Al	Mat. serie std ⁽¹⁾	Serie conduttori std	Serie conduttori racing	Serie conduttori + condotti std	Serie conduttori + condotti racing	Campana completa (Upgrade 48 denti)
MULTISTRADA 1000 DS S	1000	2005		ORG	FCD0672		FCS0672/2		KFCD001*
MULTISTRADA 1000 S	1000	2006		ORG	FCD0672		FCS0672/2		KFCD001*
PAUL SMART 1000 L.E.	1000	2006		ORG	FCD0672		FCS0672/2		KFCD001*
SPORT 1000	1000	2006		ORG	FCD0672		FCS0672/2		KFCD001*
SPORT 1000 MONOPOSTO JPN	1000	2007		ORG	FCD0672		FCS0672/2		KFCD001*
SPORT 1000	1000	2007	2008			FCD0714/1		FCS0714/3	
SPORT 1000 S	1000	2007	2009			FCD0714/1		FCS0714/3	
SPORT 1000 CLASSIC GT	1000	2007	2010			FCD0714/1		FCS0714/3	
ST3 1000	1000	2004		ORG	FCD0672		FCS0672/2		KFCD001*
ST3 1000	1000	2005	2007			FCD0714/1		FCS0714/3	
ST3 1000 ABS	1000	2006	2007			FCD0714/1		FCS0714/3	
SUPERSPORT 1000	1000	2003	2006	ORG	FCD0672		FCS0672/2		KFCD001*
1098	1100	2007	2008	ORG	FCD0717		FCS0717/2		KFCD005*
1098 S	1100	2007	2008	ORG	FCD0717		FCS0717/2		KFCD005*
1098 S TRICOLORE	1100	2007	2008	ORG	FCD0717		FCS0717/2		KFCD005*
1098 R	1200	2008	2009	SINT-ORG	FCD0669-FCD0669/0		FCS0669/2-FCS0669/20		KFCD003*
1098 R BAYLISS	1200	2009		SINT-ORG	FCD0669-FCD0669/0		FCS0669/2-FCS0669/20		KFCD003*
HYPERMOTARD 1100	1100	2008	2009	ORG	FCD0717		FCS0717/2		KFCD005*
HYPERMOTARD 1100 S	1100	2008	2009	ORG	FCD0717		FCS0717/2		KFCD005*
HYPERMOTARD 1100 EVO SP	1100	2010	2012	ORG	FCD0715		FCS0715/2		KFCD004*
HYPERMOTARD 1100 EVO	1100	2011	2012	ORG	FCD0715		FCS0715/2		KFCD004*
MONSTER 1100 S	1100	2009	2010	ORG	FCD0715		FCS0715/2		KFCD004*
MONSTER 1100 - ABS	1100	2009	2010	ORG	FCD0715		FCS0715/2		KFCD004*
MONSTER 1100 S ABS	1100	2010		ORG	FCD0715		FCS0715/2		KFCD004*
MONSTER 1100 EVO - EVO ABS	1100	2012	2013			FCD0727/1		FCS0727/3	
MONSTER 1100 DIESEL	1100	2013				FCD0727/1		FCS0727/3	
MONSTER 1100 EVO ANNIVERSARY	1100	2013				FCD0727/1		FCS0727/3	
MULTISTRADA 1100	1100	2007	2009			FCD0714/1		FCS0714/3	
MULTISTRADA 1100 S	1100	2007	2009			FCD0714/1		FCS0714/3	
STREETFIGHTER 1100	1100	2010	2011	ORG	FCD0715		FCS0715/2		KFCD004*
STREETFIGHTER 1100 S	1100	2010	2012	ORG	FCD0715		FCS0715/2		KFCD004*
1198 S	1200	2009	2010	ORG	FCD0715		FCS0715/2		KFCD004*
1198	1200	2009	2011	ORG	FCD0715		FCS0715/2		KFCD004*
1198 R CORSE	1200	2010		SINT-ORG	FCD0669-FCD0669/0		FCS0669/2-FCS0669/20		KFCD003*
1198 S CORSE	1200	2010		ORG	FCD0715		FCS0715/2		KFCD004*
1198 SP	1200	2011		SINT-ORG	FCD0669-FCD0669/0		FCS0669/2-FCS0669/20		KFCD003*
PANIGALE 1199 - ABS	1200	2012	2014			FCD0727/1		FCS0727/3	
PANIGALE 1199 TRICOLORE	1200	2012	2014			FCD0727/1		FCS0727/3	
PANIGALE 1199 S - S ABS	1200	2012	2014			FCD0727/1		FCS0727/3	

* vedi pagina 23005

(1) materiale di serie in rosso

VEICOLO / VEHICLE / VEHICULE / FAHRZEUG / VEHICULOS

Modello	CC	Dal	Al	Mat. serie std ⁽¹⁾	Serie conduttori std	Serie conduttori racing	Serie conduttori + condotti std	Serie conduttori + condotti racing	Campana completa (Upgrade 48 denti)
PANIGALE 1199 R	1200	2013	2014			FCD0727/1		FCS0727/3	
DIAVEL 1200	1200	2011	2013			FCD0727/1		FCS0727/3	
DIAVEL 1200 CARBON	1200	2011	2013			FCD0727/1		FCS0727/3	
DIAVEL 1200 BRA	1200	2012	2014			FCD0727/1		FCS0727/3	
DIAVEL 1200 CARBON BRA	1200	2012	2014			FCD0727/1		FCS0727/3	
DIAVEL 1200 AMG	1200	2013				FCD0727/1		FCS0727/3	
DIAVEL 1200 CROMO	1200	2013				FCD0727/1		FCS0727/3	
DIAVEL 1200 STRADA	1200	2013	2014			FCD0727/1		FCS0727/3	
DIAVEL 1200 WHITE STRIPE	1200	2013	2014			FCD0727/1		FCS0727/3	
DIAVEL 1200 CARBON FL	1200	2015				FCD0727/1		FCS0727/3	
MONSTER 1200	1200	2014				FCD0727/1		FCS0727/3	
MONSTER 1200 S	1200	2014				FCD0727/1		FCS0727/3	
MULTISTRADA 1200 - ABS	1200	2010	2014			FCD0727/1		FCS0727/3	
MULTISTRADA 1200 S SPORT	1200	2010	2014			FCD0727/1		FCS0727/3	
MULTISTRADA 1200 S TOURING	1200	2010	2014			FCD0727/1		FCS0727/3	
MULTISTRADA 1200 S PIKES PEAK	1200	2011	2014			FCD0727/1		FCS0727/3	
MULTISTRADA 1200 S GT	1200	2013	2014			FCD0727/1		FCS0727/3	
MULTISTRADA 1200 - ABS	1200	2015				FCD0727/1		FCS0727/3	
MULTISTRADA 1200 S	1200	2015				FCD0727/1		FCS0727/3	
MULTISTRADA 1200 S D AIR	1200	2015				FCD0727/1		FCS0727/3	

* codice e composizioni kit campana upgrade 48 denti

Modello campana completa	Materiale d'attrito	Serie conduttori	Serie conduttori + condotti
KFCD0001/2	sinterizzato	FCD0701	FCS0701/2
KFCD0001/20	organico	FCD0701/0	FCS0701/20
KFCD0002/2	sinterizzato	FCD0702	FCS0702/2
KFCD0002/20	organico	FCD0702/0	FCS0702/20
KFCD0003/2	sinterizzato	FCD0703	FCS0703/2
KFCD0003/20	organico	FCD0703/0	FCS0703/20
KFCD0004/2	sinterizzato	FCD0718	FCS0718/2
KFCD0004/20	organico	FCD0718/0	FCS0718/20
KFCD0005/2	sinterizzato	FCD0719	FCS0719/2
KFCD0005/20	organico	FCD0719/0	FCS0719/20
Evo STM	sinterizzato	FCD0576	FCS0576/2

FIGURATO FRIZIONI DUCATI

... 0568

FRIZIONE A BAGNO D'OLIO

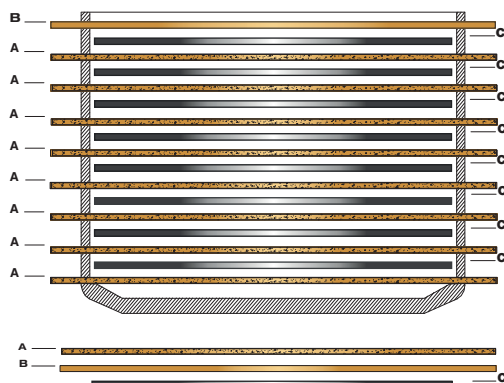

FCD0568 serie dischi conduttori

FCS0568/2 serie dischi conduttori + condotti

	nr pezzi	spessore	nr denti	descrizione	anima disco	materiale di attrito
A	8	2,5	12	disco conduttore	acciaio	sinterizzato
B	1	3,5	12	disco conduttore	acciaio	sinterizzato
C	8	1,5	37	condotto piatto	acciaio	-

FCD0568/0 serie dischi conduttori

FCS0568/20 serie dischi conduttori + condotti

	nr pezzi	spessore	nr denti	descrizione	anima disco	materiale di attrito
A	8	2,5	12	disco conduttore	acciaio	organico
B	1	3,5	12	disco conduttore	acciaio	organico
C	8	1,5	37	condotto piatto	acciaio	-

Spessore totale pacco dischi 35,5 mm

NOTE:

Il disco B ha il materiale d'attrito solo da 1 lato, va posizionato con il materiale rivolto verso il basso.
Per una corretta sequenza di montaggio, prestare attenzione al verso di bombatura dei dischi condotti.

FIGURATO FRIZIONI DUCATI

... 0576

FRIZIONE A SECCO

(Ricambio per campana 48 denti tipo STM)

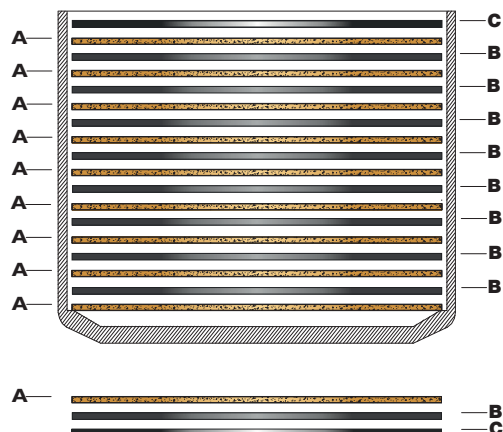

FCD0576 serie dischi conduttori

FCS0576/2 serie dischi conduttori + condotti

	nr pezzi	spessore	nr denti	descrizione	anima disco	materiale di attrito
A	9	2,5	48	disco conduttore	acciaio	sinterizzato
B	8	1,5	37	condotto piatto	acciaio	-
C	1	2,0	37	condotto piatto	acciaio	-

Spessore totale pacco dischi 36,5 mm

NOTE: Per una corretta sequenza di montaggio, prestare attenzione al verso di bombatura dei dischi condotti.

FIGURATO FRIZIONI DUCATI

... 0620 FRIZIONE A SECCO

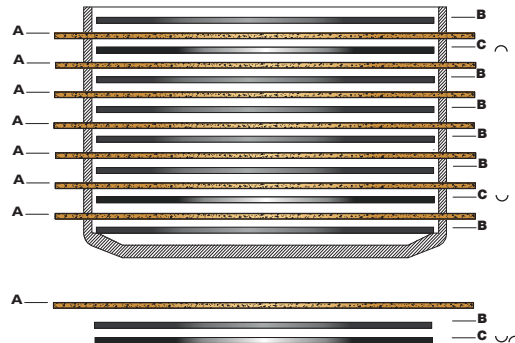

FCD0620 serie dischi conduttori

FCS0620/2 serie dischi conduttori + condotti

	nr pezzi	spessore	nr denti	descrizione	anima disco	materiale di attrito
A	7	2,5	12	disco conduttore	acciaio	sinterizzato
B	6	1,5	37	condotto piatto	acciaio	-
C	2	1,5	37	condotto bombato	acciaio	-

Spessore totale pacco dischi 29,5 mm

NOTE: Per una corretta sequenza di montaggio, prestare attenzione al verso di bombatura dei dischi condotti.

FIGURATO FRIZIONI DUCATI

... 0662 FRIZIONE A SECCO

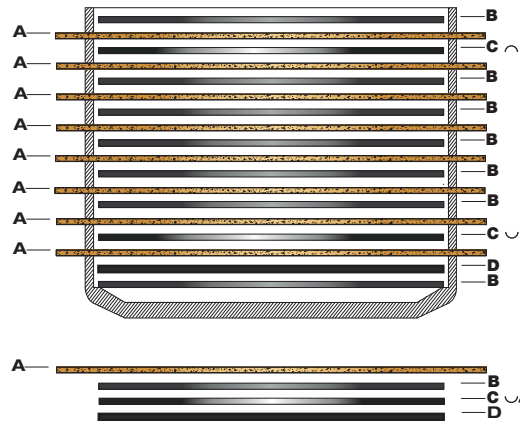

FCD0662 serie dischi conduttori

FCS0662/2 serie dischi conduttori + condotti

	nr pezzi	spessore	nr denti	descrizione	anima disco	materiale di attrito
A	8	2,5	12	disco conduttore	acciaio	sinterizzato
B	7	2,0	37	condotto piatto	acciaio	-
C	2	1,5	37	condotto bombato	acciaio	-
D	1	1,5	37	condotto piatto	acciaio	-

Spessore totale pacco dischi 38,5 mm

NOTE: Per una corretta sequenza di montaggio, prestare attenzione al verso di bombatura dei dischi condotti.

FIGURATO FRIZIONI DUCATI

... 0665

FRIZIONE A BAGNO D'OLIO

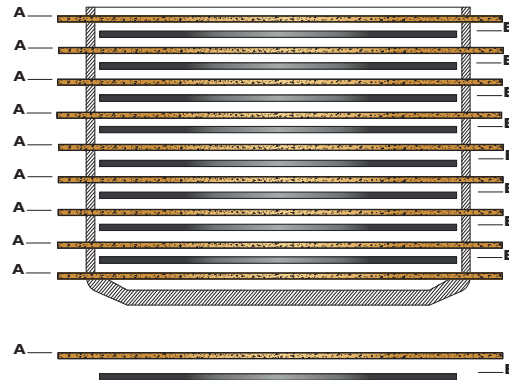

FCD0665 serie dischi conduttori

FCS0665/2 serie dischi conduttori + condotti

	nr pezzi	spessore	nr denti	descrizione	anima disco	materiale di attrito
A	9	3,5	12	disco conduttore	alluminio	organico
B	8	1,5	37	condotto piatto	acciaio	-

FCD0665/1 serie dischi conduttori

FCS0665/3 serie dischi conduttori + condotti

	nr pezzi	spessore	nr denti	descrizione	anima disco	materiale di attrito
A	9	3,5	12	disco conduttore	alluminio	carbon paper
B	8	1,5	37	condotto piatto	acciaio	-

Spessore totale pacco dischi 43,5 mm

NOTE: Per una corretta sequenza di montaggio, prestare attenzione al verso di bombatura dei dischi condotti.

FIGURATO FRIZIONI DUCATI

... 0669

FRIZIONE A SECCO

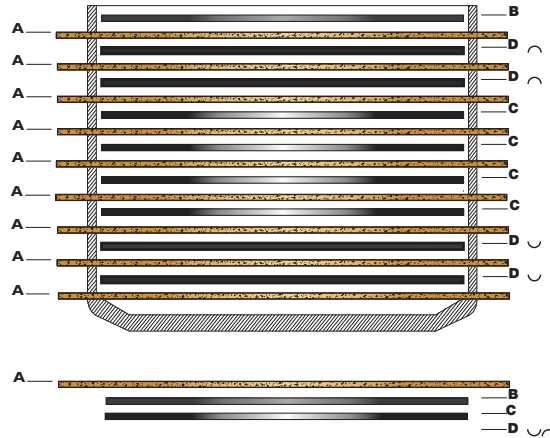

FCD0669 serie dischi conduttori

FCS0669/2 serie dischi conduttori + condotti

	nr pezzi	spessore	nr denti	descrizione	anima disco	materiale di attrito
A	9	2,5	12	disco conduttore	acciaio	sinterizzato
B	1	2,0	37	condotto piatto	acciaio	-
C	4	1,5	37	condotto piatto	acciaio	-
D	4	1,5	37	condotto bombato	acciaio	-

FCD0669/0 serie dischi conduttori

FCS0669/20 serie dischi conduttori + condotti

	nr pezzi	spessore	nr denti	descrizione	anima disco	materiale di attrito
A	9	2,5	12	disco conduttore	acciaio	organico
B	1	2,0	37	condotto piatto	acciaio	-
C	4	1,5	37	condotto piatto	acciaio	-
D	4	1,5	37	condotto bombato	acciaio	-

Spessore totale pacco dischi 36,5 mm

NOTE: Per una corretta sequenza di montaggio, prestare attenzione al verso di bombatura dei dischi condotti.

FIGURATO FRIZIONI DUCATI

... 0671

FRIZIONE A SECCO

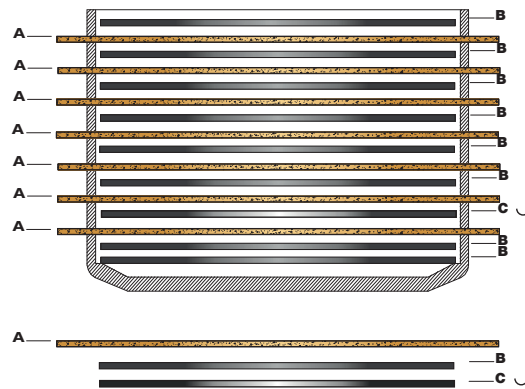

FCD0671 serie dischi conduttori

FCS0671/2 serie dischi conduttori + condotti

	nr pezzi	spessore	nr denti	descrizione	anima disco	materiale di attrito
A	7	3,0	12	disco conduttore	acciaio	sinterizzato
B	8	2,0	37	condotto piatto	acciaio	-
C	1	1,5	37	condotto bombato	acciaio	-

FCD0671/0 serie dischi conduttori

FCS0671/20 serie dischi conduttori + condotti

	nr pezzi	spessore	nr denti	descrizione	anima disco	materiale di attrito
A	7	3,0	12	disco conduttore	alluminio	organico
B	8	2,0	37	condotto piatto	acciaio	-
C	1	1,5	37	condotto bombato	acciaio	-

Spessore totale pacco dischi 38,5 mm

NOTE: Per una corretta sequenza di montaggio, prestare attenzione al verso di bombatura dei dischi condotti.

FIGURATO FRIZIONI DUCATI

... 0672 FRIZIONE A SECCO

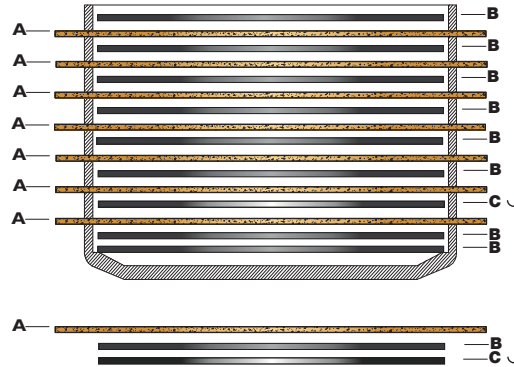

FCD0672 serie dischi conduttori
FCS0672/2 serie dischi conduttori + condotti

	nr pezzi	spessore	nr denti	descrizione	anima disco	materiale di attrito
A	7	3,0	12	disco conduttore	alluminio	organico
B	8	2,0	37	condotto piatto	acciaio	-
C	1	1,5	37	condotto bombato	acciaio	-

Spessore totale pacco dischi 38,5 mm

NOTE: Per una corretta sequenza di montaggio, prestare attenzione al verso di bombatura dei dischi condotti.

FIGURATO FRIZIONI DUCATI

...0701

FRIZIONE A SECCO

(Ricambio per campana 48 denti)

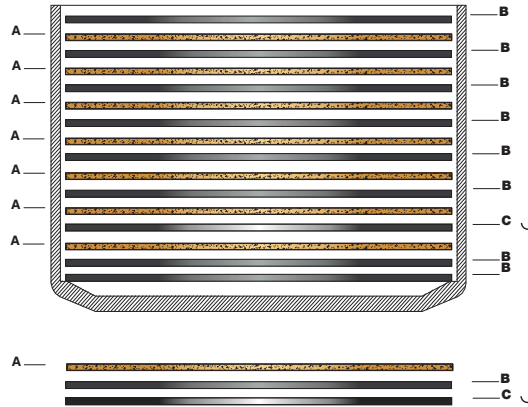

FCD0701 serie dischi conduttori
FCS0701/2 serie dischi conduttori + condotti
KFCD0001/2 kit campana frizione + serie dischi

	nr pezzi	spessore	nr denti	descrizione	anima disco	materiale di attrito
A	7	3,0	48	disco conduttore	acciaio	sinterizzato
B	8	2,0	37	condotto piatto	acciaio	-
C	1	1,5	37	condotto bombato	acciaio	-

FCD0701/0 serie dischi conduttori
FCS0701/20 serie dischi conduttori + condotti
KFCD0001/20 kit campana frizione + serie dischi

	nr pezzi	spessore	nr denti	descrizione	anima disco	materiale di attrito
A	7	3,0	48	disco conduttore	alluminio	organico
B	8	2,0	37	condotto piatto	acciaio	-
C	1	1,5	37	condotto bombato	acciaio	-

Spessore totale pacco dischi 38,5 mm

NOTE: Per una corretta sequenza di montaggio, prestare attenzione al verso di bombatura dei dischi condotti.

FIGURATO FRIZIONI DUCATI

... 0702

FRIZIONE A SECCO

(Ricambio per campana 48 denti)

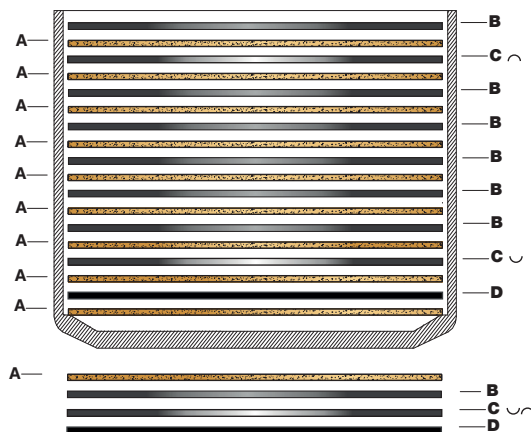

FCD0702 serie dischi conduttori
FCS0702/2 serie dischi conduttori + condotti
KFCD0002/2 kit campana frizione + serie dischi

	nr pezzi	spessore	nr denti	descrizione	anima disco	materiale di attrito
A	8	2,5	48	disco conduttore	acciaio	sinterizzato
B	7	2,0	37	condotto piatto	acciaio	-
C	2	1,5	37	condotto bombato	acciaio	-
D	1	1,5	37	condotto piatto	acciaio	-

FCD0702/0 serie dischi conduttori
FCS0702/20 serie dischi conduttori + condotti
KFCD0002/20 kit campana frizione + serie dischi

	nr pezzi	spessore	nr denti	descrizione	anima disco	materiale di attrito
A	8	2,5	48	disco conduttore	alluminio	organico
B	7	2,0	37	condotto piatto	acciaio	-
C	2	1,5	37	condotto bombato	acciaio	-
D	1	1,5	37	condotto piatto	acciaio	-

Spessore totale pacco dischi 38,5 mm

NOTE: Per una corretta sequenza di montaggio, prestare attenzione al verso di bombatura dei dischi condotti.

FIGURATO FRIZIONI DUCATI

... 0703

FRIZIONE A SECCO

(Ricambio per campana 48 denti)

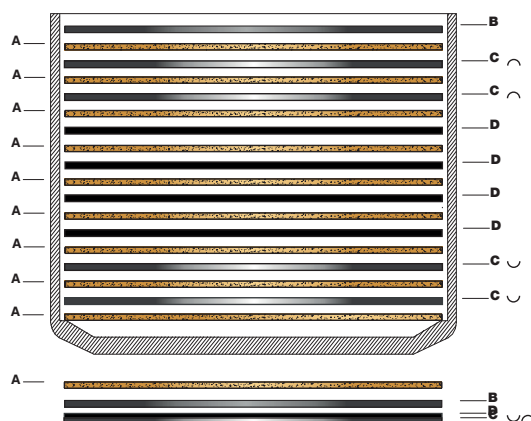

FCD0703 serie dischi conduttori
FCS0703/2 serie dischi conduttori + condotti
KFCD0003/2 kit campana frizione + serie dischi

	nr pezzi	spessore	nr denti	descrizione	anima disco	materiale di attrito
A	9	2,5	48	disco conduttore	acciaio	sinterizzato
B	1	2,0	37	condotto piatto	acciaio	-
C	4	1,5	37	condotto bombato	acciaio	-
D	4	1,5	37	condotto piatto	acciaio	-

FCD0703/0 serie dischi conduttori
FCS0703/20 serie dischi conduttori + condotti
KFCD0003/20 kit campana frizione + serie dischi

	nr pezzi	spessore	nr denti	descrizione	anima disco	materiale di attrito
A	9	2,5	48	disco conduttore	alluminio	organico
B	1	2,0	37	condotto piatto	acciaio	-
C	4	1,5	37	condotto bombato	acciaio	-
D	4	1,5	37	condotto piatto	acciaio	-

Spessore totale pacco dischi 36,5 mm

NOTE: Per una corretta sequenza di montaggio, prestare attenzione al verso di bombatura dei dischi condotti.

FIGURATO FRIZIONI DUCATI

... 0714

FRIZIONE A BAGNO D'OLIO

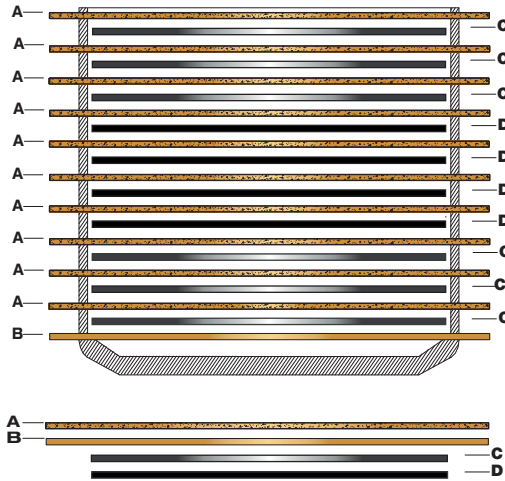

FCD0714/1 serie dischi conduttori

FCS0714/3 serie dischi conduttori + condotti

	nr pezzi	spessore	nr denti	descrizione	anima disco	materiale di attrito
A	10	3,0	10	disco conduttore	alluminio	carbon paper
B	1	3,0	10	disco conduttore	alluminio	carbon paper
C	6	1,6	25	condotto piatto	acciaio	-
D	4	2,0	25	condotto piatto	acciaio	-

Spessore totale pacco dischi 50,6 mm

NOTE: Per una corretta sequenza di montaggio, prestare attenzione al verso di bombatura dei dischi condotti.

FIGURATO FRIZIONI DUCATI

... 0715 FRIZIONE A SECCO

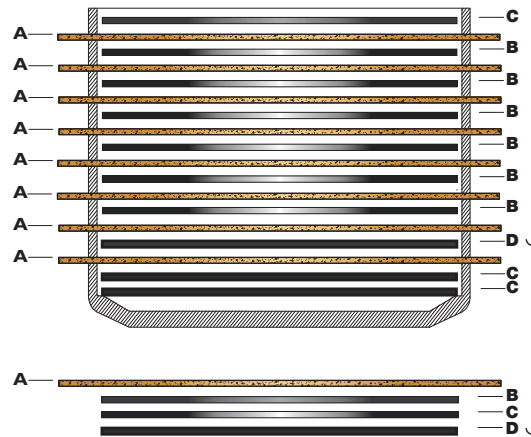

FCD0715 serie dischi conduttori
FCS0715/2 serie dischi conduttori + condotti

	nr pezzi	spessore	nr denti	descrizione	anima disco	materiale di attrito
A	8	3,0	12	disco conduttore	alluminio	organico
B	6	1,5	37	condotto piatto	acciaio	-
C	3	2,0	37	condotto piatto	acciaio	-
D	1	1,5	37	condotto bombato	acciaio	-

Spessore totale pacco dischi 40,5 mm

NOTE: Per una corretta sequenza di montaggio, prestare attenzione al verso di bombatura dei dischi condotti.

FIGURATO FRIZIONI DUCATI

... 0717

FRIZIONE A SECCO

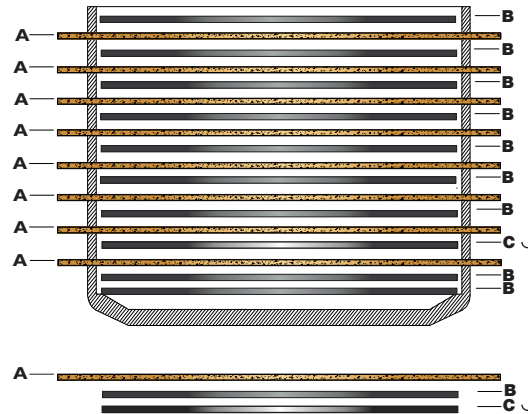

FCD0717 serie dischi conduttori

FCS0717/2 serie dischi conduttori + condotti

	nr pezzi	spessore	nr denti	descrizione	anima disco	materiale di attrito
A	8	3,0	12	disco conduttore	alluminio	organico
B	9	1,5	37	condotto piatto	acciaio	-
C	1	1,5	37	condotto bombato	acciaio	-

Spessore totale pacco dischi 39,00 mm

NOTE: Per una corretta sequenza di montaggio, prestare attenzione al verso di bombatura dei dischi condotti.

FIGURATO FRIZIONI DUCATI

... 0718

FRIZIONE A SECCO

(Ricambio per campana 48 denti)

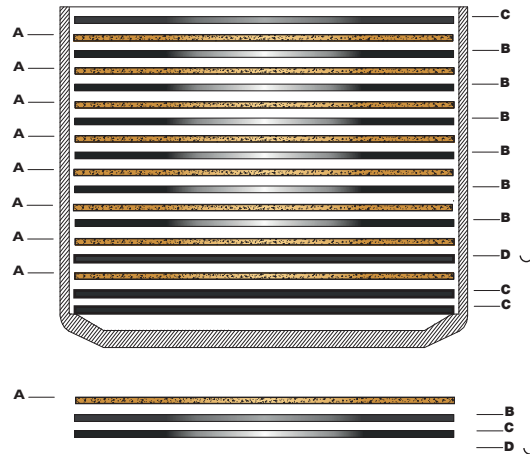

FCD0718 serie dischi conduttori
FCS0718/2 serie dischi conduttori + condotti
KFCD0004/2 kit campana frizione + serie dischi

	nr pezzi	spessore	nr denti	descrizione	anima disco	materiale di attrito
A	8	3,0	48	disco conduttore	acciaio	sinterizzato
B	6	1,5	37	condotto piatto	acciaio	-
C	3	2,0	37	condotto piatto	acciaio	-
D	1	1,5	37	condotto bombato	acciaio	-

FCD0718/0 serie dischi conduttori
FCS0718/20 serie dischi conduttori + condotti
KFCD0004/20 kit campana frizione + serie dischi

	nr pezzi	spessore	nr denti	descrizione	anima disco	materiale di attrito
A	8	3,0	48	disco conduttore	alluminio	organico
B	6	1,5	37	condotto piatto	acciaio	-
C	3	2,0	37	condotto piatto	acciaio	-
D	1	1,5	37	condotto bombato	acciaio	-

Spessore totale pacco dischi 40,50 mm

NOTE: Per una corretta sequenza di montaggio, prestare attenzione al verso di bombatura dei dischi condotti.

FIGURATO FRIZIONI DUCATI

...0719

FRIZIONE A SECCO

(Ricambio per campana 48 denti)

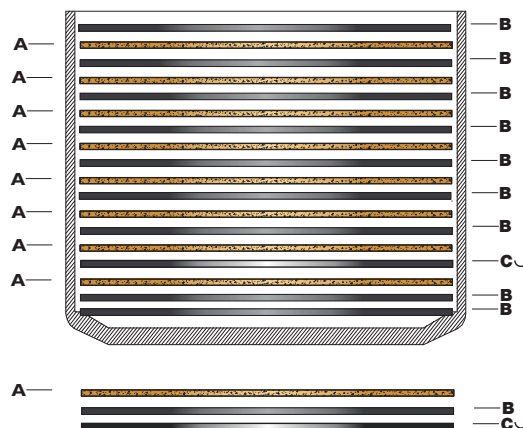

FCD0719 serie dischi conduttori
FCS0719/2 serie dischi conduttori + condotti
KFCD0005/2 kit campana frizione + serie dischi

	nr pezzi	spessore	nr denti	descrizione	anima disco	materiale di attrito
A	8	3,0	48	disco conduttore	acciaio	sinterizzato
B	9	1,5	37	condotto piatto	acciaio	-
C	1	1,5	37	condotto bombato	acciaio	-

FCD0719/0 serie dischi conduttori
FCS0719/20 serie dischi conduttori + condotti
KFCD0005/20 kit campana frizione + serie dischi

	nr pezzi	spessore	nr denti	descrizione	anima disco	materiale di attrito
A	8	3,0	48	disco conduttore	alluminio	organico
B	9	1,5	37	condotto piatto	acciaio	-
C	1	1,5	37	condotto bombato	acciaio	-

Spessore totale pacco dischi 39,00 mm

NOTE: Per una corretta sequenza di montaggio, prestare attenzione al verso di bombatura dei dischi condotti.

FIGURATO FRIZIONI DUCATI

... 0720 FRIZIONE A BAGNO D'OLIO

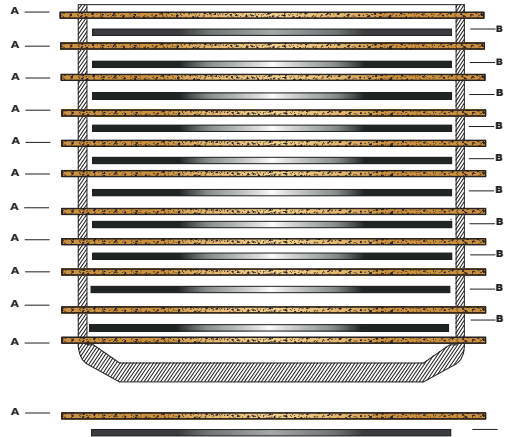

FCD0720 serie dischi conduttori
FCS0720/2 serie dischi conduttori + condotti

	nr pezzi	spessore	nr denti	descrizione	anima disco	materiale di attrito
A	11	3,5	12	disco conduttore	alluminio	organico
B	10	1,5	32	condotto piatto	acciaio	-

Spessore totale pacco dischi 53,5 mm

NOTE: Per una corretta sequenza di montaggio, prestare attenzione al verso di bombatura dei dischi condotti.

FIGURATO FRIZIONI DUCATI

... 0727 FRIZIONE A BAGNO D'OLIO

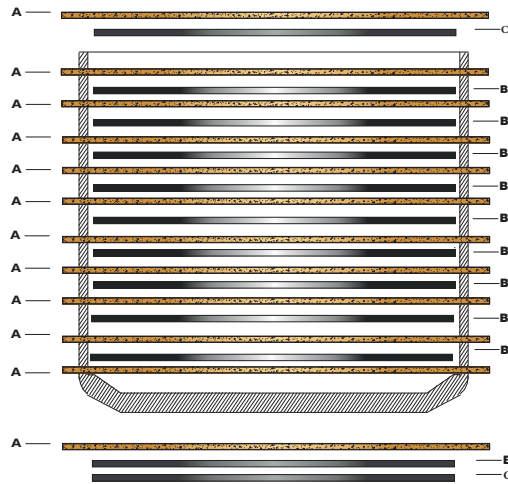

FCD0727/1 serie dischi conduttori

FCS0727/3 serie dischi conduttori + condotti

	nr pezzi	spessore	nr denti	descrizione	anima disco	materiale di attrito
A	11	2,8	12	disco conduttore	alluminio	carbon paper
B	9	2,0	34	condotto piatto	acciaio	-
C	1	2,0	36	condotto piatto	acciaio	-

Spessore totale pacco dischi 39,00 mm

NOTE: Per una corretta sequenza di montaggio, prestare attenzione al verso di bombatura dei dischi condotti.







RACING

SPECIAL CLUTCH KITS OTHER APPLICATIONS

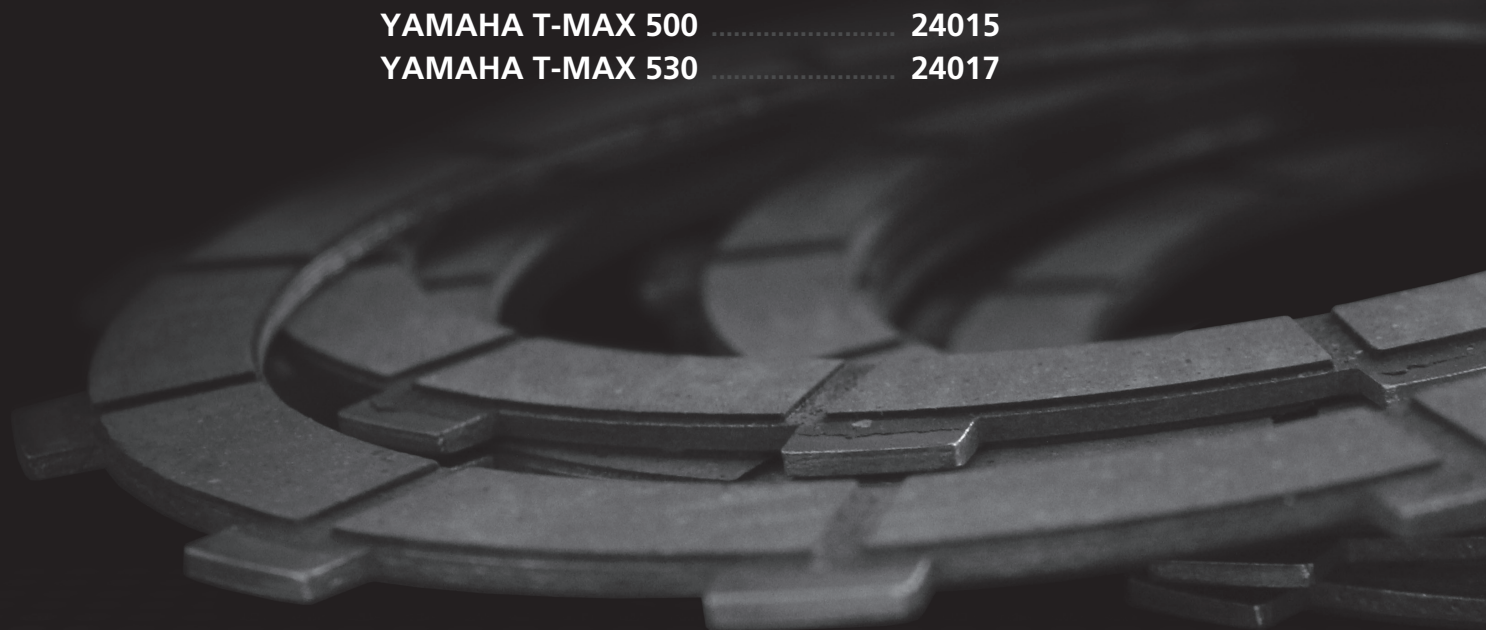
PIAGGIO	24000
VESPA VINTAGE	24007
MORINI	24010
DERBI	24011
MINARELLI	24012
LAMBRETTA	24014
YAMAHA T-MAX 500	24015
YAMAHA T-MAX 530	24017



FRIZIONI COMPLETE PIAGGIO PIAGGIO CLUTCH KITS

	COD.	Z.	NOTE
	FCC 0501	Z20	Con/Avec/With/Mit FCS 0518/2
	FCC 0525	Z21	Con/Avec/With/Mit FCS 0518/2
	FCC 0533	Z23	Con/Avec/With/Mit FCS 0518/2
	FCC 0562	Z22	Con/Avec/With/Mit FCS 0518/2

	COD.	Z.	NOTE
	FCC 0501 R	Z20	Con/Avec/With/Mit FCS 0518/2
	FCC 0525 R	Z21	Con/Avec/With/Mit FCS 0518/2
	FCC 0533 R	Z23	Con/Avec/With/Mit FCS 0518/2
	FCC 0562 R	Z22	Con/Avec/With/Mit FCS 0518/2

CON ANELLO DI RINFORZO
 AVEC ANNEAU RENFORCE RENFORCED RING
 CON ANELLO RENFORZADO MIT VERSTAERKERUNGSRING

	FCC 0512		Con/Avec/With/Mit FCS 0507/2
	FCC 0512 M		Con/Avec/With/Mit FCS 0507 M
	FCC 0512 MR		Con/Avec/With/Mit FCS 0507 MR

	COD.	Z.		NOTE
	FCC 0526	Z22	Boccolo 36 mm	Con/Avec/With/Mit FCS 0607/2
	FCC 0518	Z21		Con/Avec/With/Mit FCS 0607/2
	FCC 0510	Z20		Con/Avec/With/Mit FCS 0607/2
	FCC 0534	Z22	Boccolo 38 mm	Con/Avec/With/Mit FCS 0607/2
	FCC 0526 M	Z22	Boccolo 36 mm	Con/Avec/With/Mit FCS 0607 M
	FCC 0518 M	Z21		Con/Avec/With/Mit FCS 0607 M
	FCC 0510 M	Z20		Con/Avec/With/Mit FCS 0607 M
	FCC 0534 M	Z22	Boccolo 38 mm	Con/Avec/With/Mit FCS 0607 M

	FCC 0519		Con/Avec/With/Mit FCS 0554/2
	FCC 0519 M		Con/Avec/With/Mit FCS 0554 M

	FCC 0502		Con/Avec/With/Mit FCS 0578/2
	FCC 0502 M		Con/Avec/With/Mit FCS 0578 M
	FCC 0502 MR		Con/Avec/With/Mit FCS 0578 MR

CAMPANE FRIZIONE PIAGGIO VESPA PIAGGIO VESPA CLUTCH BASKETS

CORONA E PIGNONE

Engrainage primaire
Clutch basket with primary gear sprocket
Campana y piñón
Kupplungskorb mit Primär Zahnkranz



FCB 0037

VESPA 50-90-125

Denti elicoidali Z67-18- senza parastrappi

Dents hélicoïdaux sans pignon élastique
Helicoidal teeth without shock absorber
Con dientes helicoidales sin piñón elástico
Schräg verzahnt ohne Ruckdämpfer

FCB 0038

VESPA 50-90-125

Denti elicoidali Z63-22- con parastrappi

Dents hélicoïdaux avec pignon élastique
Helicoidal teeth with shock absorber
Con dientes helicoidales y piñón elástico
Schräg verzahnt mit Ruckdämpfer

FCB 0039

VESPA 50-90-125

Denti elicoidali Z61-24- con parastrappi

Dents hélicoïdaux avec pignon élastique
Helicoidal teeth with shock absorber
Con dientes helicoidales y piñón elástico
Schräg verzahnt mit Ruckdämpfer

FCB 0040

VESPA 50-90-125

Denti dritti Z69-27- con parastrappi

Dents droites avec pignon élastique
Straight-cut teeth with shock absorber
Con dientes rectos y piñón elástico
Gerade verzahnt mit Ruckdämpfer

FCB 0041

VESPA 50-90-125

Denti dritti Z72-24- con parastrappi

Dents droites avec pignon élastique
Straight-cut teeth with shock absorber
Con dientes rectos y piñón elástico
Gerade verzahnt mit Ruckdämpfer

FCB 0042

VESPA 50-90-125

Denti dritti Z68-29- con parastrappi

Dents droites avec pignon élastique
Straight-cut teeth with shock absorber
Con dientes rectos y piñón elástico
Gerade verzahnt mit Ruckdämpfer

FCB 0043

VESPA FL2-HP

Denti elicoidali Z69-14- con parastrappi

Dents hélicoïdaux avec pignon élastique
Helicoidal teeth with shock absorber
Con dientes helicoidales y piñón elástico
Schräg verzahnt mit Ruckdämpfer

FRIZIONI PER MOTORI PIAGGIO PIAGGIO CLUTCH KITS

VESPA 50FL2 V/50FL2 HP/125FL2 V - APE 50 FL/FL2/FL3/RST MIX



FCD 0507

SERIE DISCHI CONDOTTORI

- Jeux disques garnis
- Friction plates set
- Serie conductores
- Reibscheiben



FCS 0507/2

SERIE DISCHI CONDOTTORI
+ CONDOTTI

- Jeux disques garnis + disques lisses
- Set of friction plates + steel plates
- Serie conductores + conductos
- Reib- und stahlscheiben



FCS 0507/2S

SERIE DISCHI CONDOTTORI
+ CONDOTTI
+ 6 MOLLE

- Jeux disques garnis + disques lisses + 6 ressorts
- Set of friction plates + steel plates + 6 springs
- Serie conductores + conductos + 6 muelles
- Reib- und stahlscheiben + 6 Federn



FCS 0507 M

SERIE MODIFICA FRIZIONE
4 DISCHI CONDOTTORI
+ 3 DISCHI CONDOTTI ACCIAIO BLU
+ 6 MOLLE

- Jeux disques modifies 4 garnis + 3 disques lisses en acier bleu + 6 ressorts
- Modified set of 4 friction plates + 3 steel blue plates + 6 springs
- Serie modifica 4 conductores + 3 conductos en acero blu + 6 muelles
- 4 modifizierte Reibscheiben + 3 oberflächenbehandelte Stahlscheiben + 6 Federn



FCS 0507 MML

SERIE MODIFICA FRIZIONE 4 DISCHI
CONDOTTORI + 3 DISCHI CONDOTTI
ACCIAIO BLU + 12 MOLLE

- Jeux disques modifies 4 garnis + 3 disques lisses en acier bleu + 12 ressorts
- Modified set of 4 friction plates + 3 steel blue plates + 12 springs
- Serie modifica 4 conductores + 3 conductos en acero blu + 12 muelles
- 4 modifizierte Reibscheiben + 3 oberflächenbehandelte Stahlscheiben + 12 Federn



FCS 0507 MR

SERIE MODIFICA FRIZIONE
4 DISCHI CONDOTTORI RACING
+ 3 DISCHI CONDOTTI ACCIAIO BLU
+ 6 MOLLE

- Jeux disques racing modifies 4 garnis + 3 disques lisses en acier bleu + 6 ressorts
- Modified set of 4 racing friction plates + 3 steel blue plates + 6 springs
- Serie modifica racing 4 conductores + 3 conductos en acero blu + 6 muelles
- 4 modifizierte Reibscheiben + 3 oberflächenbehandelte Stahlscheiben + 6 Federn



FCS 0507 MMR

SERIE MODIFICA FRIZIONE
4 DISCHI CONDOTTORI RACING
+ 3 DISCHI CONDOTTI ACCIAIO BLU
+ 12 MOLLE

- Jeux disques racing modifies 4 garnis + 3 disques lisses en acier bleu + 12 ressorts
- Modified set of 4 racing friction plates + 3 steel blue plates + 12 springs
- Serie modifica racing 4 conductores + 3 conductos en acero blu + 12 muelles
- 4 modifizierte Reibscheiben + 3 oberflächenbehandelte Stahlscheiben + 12 Federn



Disponibili anche le versioni FCS 0507 ME e FCS 0507 MME

FRIZIONI PER MOTORI PIAGGIO PIAGGIO CLUTCH KITS

COSA 2 125/150/200 91 → 97 - VESPA PX125/150/200 98 →



FCD 0518 SERIE DISCHI CONDUTTORI

- Jeux disques garnis
- Friction plates set
- Serie conductores
- Reibscheiben



FCD 0518/1 SERIE DISCHI CONDUTTORI RACING

- Jeux disques garnis racing
- Racing friction plates set
- Serie conductores racing
- Racing Reibscheiben



FCS 0518/2 SERIE DISCHI CONDUTTORI + CONDOTTI

- Jeux disques garnis + disques lisses
- Set of friction plates + steel plates
- Serie conductores + conductos
- Reib- und Stahlscheiben



FCS 0518/3 SERIE DISCHI CONDUTTORI RACING + CONDOTTI

- Jeux disques garnis racing + disques lisses
- Set of racing friction plates + steel plates
- Serie conductores racing + conductos
- Racing Reibscheiben + Stahlscheiben



FCS 0518/2S SERIE DISCHI CONDUTTORI + CONDOTTI + MOLLE

- Jeux disques garnis + disques lisses + ressorts
- Set of friction plates + steel plates + springs
- Serie conductores + conductos + muelles
- Reibscheiben + oberflächenbehandelte Stahlscheiben + Federn.



FCS 0518/3S SERIE DISCHI CONDUTTORI RACING + CONDOTTI + MOLLE

- Jeux disques garnis racing + disques lisses + ressorts
- Racing friction plates set + steel + springs
- Serie conductores racing + conductos + muelles
- Racing Reibscheiben + oberflächenbehandelte Stahlscheiben + Federn.



FRIZIONI PER MOTORI PIAGGIO PIAGGIO CLUTCH KITS

COSA 1 125/150/200 CL/CLX/CL2
VESPA 200 PXE - 180 SS - 200 PX ARCOBALENO



FCD 0554 **SERIE DISCHI CONDOTTORI**

- Jeux disques garnis
- Friction plates set
- Serie conductores
- Reibscheiben



FCS 0554/2 **SERIE DISCHI CONDOTTORI** **+ CONDOTTI**

- Jeux disques garnis
+ disques lisses
- Set of friction plates
+ steel plates
- Serie conductores + conductos
- Reib-und Stahlscheiben



FCS 0554 M **SERIE MODIFICA FRIZIONE** **4 DISCHI CONDOTTORI** **+ 3 DISCHI CONDOTTI + 7 MOLLE**

- Jeux disques modifies 4 garnis
+ 3 disques lisses + 7 ressorts
- Modified set of 4 friction plates
+ 3 steel + 7 springs
- Serie modifica 4 conductores
+ 3 conductos + 7 muelles
- 4 modifizierte Reibscheiben
+ 3 oberflächenbehandelte
Stahlscheiben + 7 Federn

FRIZIONI PER MOTORI PIAGGIO PIAGGIO CLUTCH KITS

VESPA 50/90/125 - PK 50/125/125/XL - PK 125 XL2 - APE 50P/50 TM P



FCD 0578 SERIE DISCHI CONDOTTORI

- Jeux disques garnis
- Friction plates set
- Serie conductores
- Reibscheiben



FCS 0578 ME SERIE MODIFICA FRIZIONE 4 DISCHI CONDOTTORI + 3 DISCHI CONDOTTI + 1 MOLLA

- Jeux modifie de 4 disques garnis + 3 disques lisses + 1 ressort
- Modified set of 4 friction plates + 3 steel plates + 1 spring
- Kit embrague modificado 4 conductores + 3 conductos + 1 muelle
- 4 modifizierte Reibscheiben + 3 oberflächenbehandelte Stahlscheiben + 1 Federn



FCS 0578/2 SERIE DISCHI CONDOTTORI + CONDOTTI

- Jeux disques garnis + disques lisses
- Set of friction plates + steel plates
- Serie conductores + conductos
- Reib- und Stahlscheiben



FCS 0578 M SERIE MODIFICA FRIZIONE 4 DISCHI CONDOTTORI + 3 DISCHI CONDOTTI IN ACCIAIO BLU + 1 MOLLA

- Jeux de disques modifies 4 garnis + 3 disques lisses en acier bleu + 1 ressort
- Modified set of 4 friction plates + 3 steel blue plates + 1 spring
- Serie modifica 4 conductores + 3 conductos en acero blu + 1 muelle
- 4 modifizierte Reibscheiben + 3 oberflächenbehandelte Stahlscheiben + 1 Federn



FCS 0578/2S SERIE DISCHI CONDOTTORI + CONDOTTI + 1 MOLLA

- Jeux disques garnis + disques lisses + 1 ressort
- Set of friction plates + steel plates + 1 spring
- Serie conductores + conductos + 1 muelle
- Reib- und Stahlscheiben + 1 Federn



FCS 0578 MR SERIE MODIFICA FRIZIONE 4 DISCHI CONDOTTORI RACING + 3 DISCHI CONDOTTI ACCIAIO BLU + 1 MOLLA

- Jeux disques racing modifies 4 garnis + 3 disques lisses en acier bleu + 1 ressort
- Modified set of 4 racing friction plates + 3 steel blue plates + 1 spring
- Serie modifica racing 4 conductores + 3 conductos en acero blu + 1 muelle
- 4 modifizierte Reibscheiben + 3 oberflächenbehandelte Stahlscheiben + 1 Federn

FRIZIONI PER MOTORI PIAGGIO PIAGGIO CLUTCH KITS

VESPA PX 125/150 → 94 - 150 SPRINT/SUPER - 160 GS



FCD 0607 Serie dischi conduttori

- Jeux disques garnis
- Friction plates set
- Serie conductores
- Reibscheiben



FCS 0607/2 Serie dischi conduttori + condotti

- Jeux disques garnis
+ disques lisses
- Set of friction plates
+ steel plates
- Serie conductores + conductos
- Reib- und Stahlscheiben



FCS 0607 M Serie modifica frizione 4 dischi conduttori + 3 dischi condotti + 6 molle

- Jeux disques modifies 4 garnis + 3
disques lisses + 6 ressorts Modified
- set of 4 friction plates
+ 3 steel + 6 springs
- Serie modifica 4 conductores
+ 3 conductos + 6 muelles
- 4 modifizierte Reibscheiben
+ 3 oberflächenbehandelte
Stahlscheiben + 6 Federn

VESPA VINTAGE

VESPA 125 VN 1/2T '55 → '57 VESPA 150 VL 1/2/3T '55 → '57

FCD 0721

Serie dischi conduttori

- ① Jeux disques garnis
- ② Friction plates set
- ③ Serie conductores
- ④ Reibscheiben



FCS0721/2

Serie dischi conduttori + condotti

- ① Jeux disques garnis + disques lisses Set
- ② of friction plates + steel plates Serie
- ③ conductores + conductos Reib-und
- ④ Stahlscheiben



FCS0721/2S

Serie dischi conduttori + condotti + molla

- ① jeux disques garnis + disques lisses + ressorts
- ② Set of friction plates + steel plates + springs
- ③ Serie conductores + conductos + muelles
- ④ Reibscheiben + oberflächenbehandelte Stahlscheiben + Federn

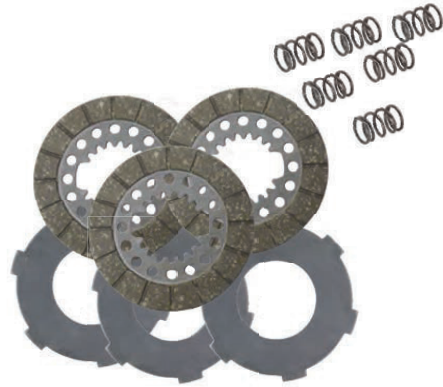

VESPA 125 '53 → '54 VM 1/2 T - VU1T

FCD 0722

Serie dischi conduttori

- ① Jeux disques garnis Friction
- ② plates set
- ③ Serie conductores
- ④ Reibscheiben



FCS0722/2

Serie dischi conduttori + condotti

- ① Jeux disques garnis + disques lisses
- ② Set of friction plates + steel plates
- ③ Serie conductores + conductos
- ④ Reib-und Stahlscheiben

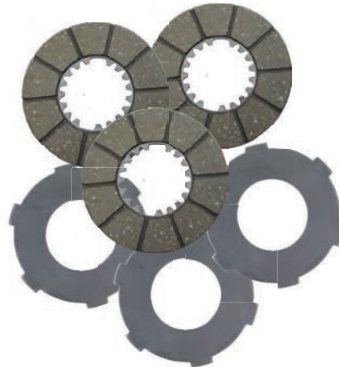

FCS0722/2S

Serie dischi conduttori + condotti + molla

- ① Jeux disques garn + disques lisses + ressorts
- ② Set of friction plates + steel plates + springs
- ③ Serie conductores + conductos + muelles
- ④ Reibscheiben + oberflächenbehandelte Stahlscheiben + Federn

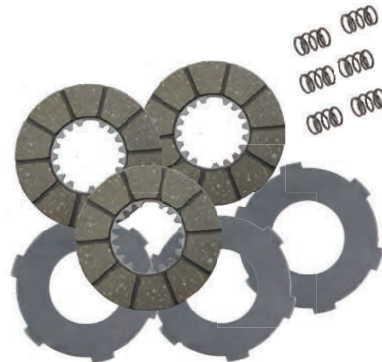

VESPA VINTAGE

VESPA 98 - '46 → '52

FCD 0723

Serie dischi conduttori

- Jeux disques garnis
- Friction plates set Serie
- conductores
- Reibscheiben



VESPA 125 - '46 → '52

FCS 0723/2

Serie dischi conduttori + condotti

- Jeux disques garnis + disques lisses
- Set of friction plates + steel plates
- Serie conductores + conductos
- Reib-und Stahlscheiben



dal V1T AL V15T dal V30T AL V33T

FCS 0723/2S

Serie dischi conduttori + condotti + molla

- Jeux disques garnis + disques lisses + ressorts
- Set of friction plates + steel plates + springs
- Serie conductores + conductos + muelles
- Reibscheiben + oberflächenbehandelte Stahlscheiben + Federn

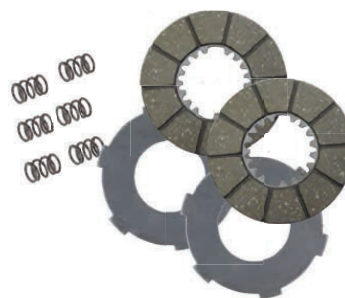

VESPA VINTAGE

VESPA 150 GS

VS 1 '55

FCD 0724

Serie dischi conduttori

- ① Jeux disques garnis
- ② Friction plates set Serie
- ③ conductores
- ④ Reibscheiben



FCS 0724/2

Serie dischi conduttori + condotti

- ① Jeux disques garnis + disques lisses
- ② Set of friction plates + steel plates
- ③ Serie conductores + conductos
- ④ Reib- und Stahlscheiben



FCS 0724/2S

Serie dischi conduttori + condotti + molla

- ① Jeux disques garnis+ disques lisses + ressorts
- ② Set of friction plates + steel plates + springs
- ③ Serie conductores + conductos + muelleS
- ④ Reibscheiben + oberflächenbehandelte Stahlscheiben + Federn

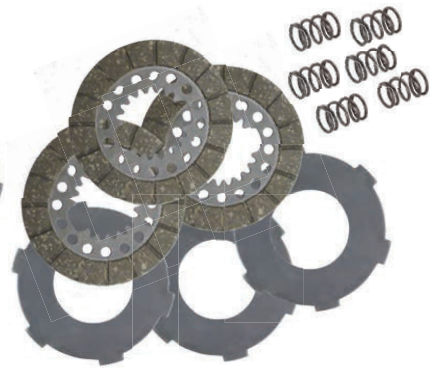

VESPA 150 GS VS 2-3-4 '56 '58 VS 5 (tel. 47351 → fino a 63168) '59 → '61

FCD 0725

Serie dischi conduttori

- ① Jeux disques garnis
- ② Friction plates set Serie
- ③ conductores
- ④ Reibscheiben



FCS 0725/2

Serie dischi conduttori + condotti

- ① Jeux disques garnis + disques lisses
- ② Set of friction plates + steel plates
- ③ Serie conductores + conductos
- ④ Reib- und Stahlscheiben



FCS 0725/2S

Serie dischi conduttori + condotti + molla

- ① Jeux disques garnis+ disques lisses + ressorts
- ② Set of friction plates + steel plates + springs
- ③ Serie conductores + conductos + muelles
- ④ Reibscheiben + oberflächenbehandelte Stahlscheiben + Federn

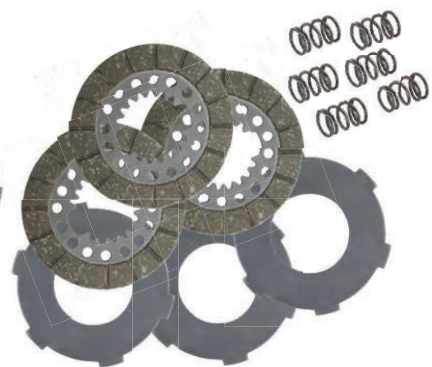

FRIZIONI PER MOTORI MORINI 50 CC

MOTO MORINI CLUTCH KITS

MOTORI FRANCO MORINI T4-TA5 6 MARCE - TOP G 60



FCD 0548 SERIE DISCHI CONDOTTORI

- Jeux disques garnis
- Friction plates set
- Serie conductores
- Reibscheiben



FCS 0548 M SERIE MODIFICA FRIZIONE 4 + 1 DISCHI CONDOTTORI + 3 DISCHI CONDOTTI + 4 MOLLE

- Jeux de disques modifies 4 + 1 garnis + 3 disques lisses + 4 ressorts
- Modified set of 4 + 1 friction plates + 3 steel + 4 springs
- Serie modifica 4+1 conductores + 3 conductos + 4 muelles
- 4+1 modifizierte Reibscheiben + 3 oberflächenbehandelte Stahlscheiben + 4 Federn



FCS 0548/2 SERIE DISCHI CONDOTTORI + CONDOTTI

- Jeux disques garnis + disques lisses
- Set of friction plates + steel plates
- Serie conductores + conductos
- Reib- und Stahlscheiben



FCS 0548 MR SERIE MODIFICA FRIZIONE 4+1 DISCHI CONDOTTORI RACING + 3 DISCHI CONDOTTI + 4 MOLLE

- Jeux disques racing modifies 4 + 1 garnis + 3 disques lisses + 4 ressorts
- Modified set of 4+1 racing friction plates + 3 steel + 4 springs
- Serie modifica racing 4+1 conductores + 3 conductos + 4 muelles
- 4+1 modifizierte Reibscheiben + 3 oberflächenbehandelte Stahlscheiben + 4 Federn

FRIZIONI PER MOTORI DERBI 50 CC

DERBI CLUTCH KITS

SENDA 50 ALL MODELS - GPR 50 ALL MODELS -
APRILIA RX 50 - SX 50 - RS 50



FCD 0585

SERIE DISCHI CONDUTTORI

- Jeux disques garnis
- Friction plates set
- Serie conductores
- Reibscheiben



FCD 0585/1

SERIE DISCHI CONDUTTORI RACING

- Jeux disques garnis racing
- Racing friction plates set
- Serie conductores racing
- Racing Reibscheiben



FCS 0585/2

SERIE DISCHI CONDUTTORI + CONDOTTI

- Jeux disques garnis + disques lisses
- Set of friction plates + steel plates
- Serie conductores + conductos
- Reib-und Stahlscheiben



FCS 0585/3

SERIE DISCHI CONDUTTORI RACING + CONDOTTI

- Jeux disques garnis racing + disques lisses
- Set of racing friction plates + steel plates
- Serie conductores racing + conductos
- Racing Reibscheiben + Stahlscheiben



FCS 0585/2S

SERIE DISCHI CONDUTTORI + CONDOTTI + 5 MOLLE

- Jeux disques garnis + disques lisses + 5 ressorts
- Set of friction plates + steel plates + 5 springs
- Serie conductores + conductos + 5 muelles
- Modifizierte Reibscheiben + oberflächenbehandelte Stahlscheiben + 5 Federn.



FCS 0585/3S

SERIE DISCHI CONDUTTORI RACING + CONDOTTI + 5 MOLLE

- Jeux disques garnis racing + disques lisses + 5 ressorts
- Racing friction plates set + steel + 5 springs
- Serie conductores racing + conductos + 5 muelles
- Modifizierte Reibscheiben + oberflächenbehandelte Stahlscheiben + 5 Federn



FCS 0585 M

SERIE MODIFICA FRIZIONE 5 DISCHI CONDUTTORI + 4 DISCHI CONDOTTI + 5 MOLLE

- Jeux disques modifies 5 garnis + 4 disques lisses + 5 ressorts
- Modified set of 5 friction plates + 4 steel blue plates + 5 springs
- Serie modifica 5 conductores + 4 conductos en acero blu + 5 muelles
- 5 modifizierte Reibscheiben + 4 oberflächenbehandelte Stahlscheiben + 5 Federn



FCS 0585 MR

SERIE MODIFICA FRIZIONE 5 DISCHI CONDUTTORI RACING + 4 DISCHI CONDOTTI + 5 MOLLE

- Jeux disques racing modifies 5 garnis + 4 disques lisses en acier bleu + 5 ressorts
- Modified set of 5 racing friction plates + 4 steel blue plates + 5 springs
- Serie modifica racing 5 conductores + 4 conductos en acero blu + 5 muelles
- 5 modifizierte Reibscheiben + 4 oberflächenbehandelte Stahlscheiben + 5 Federn



FRIZIONI PER MOTORI MINARELLI 50 CC

MINARELLI CLUTCH KITS

MOTORI MINARELLI AM 345-AM 6



FCD 0608

SERIE DISCHI CONDOTTORI

- Jeux disques garnis
- Friction plates set
- Serie conductores
- Reibscheiben



FCD 0608/1

SERIE DISCHI CONDOTTORI RACING

- Jeux disques garnis racing
- Racing friction plates set
- Serie conductores racing
- Racing Reibscheiben



FCS 0608/2

SERIE DISCHI CONDOTTORI + CONDOTTI

- Jeux disques garnis + disques lisses
- Set of friction plates + steel plates
- Serie conductores + conductos
- Reib-und Stahlscheiben



FCS 0608/3

SERIE DISCHI CONDOTTORI RACING + CONDOTTI

- Jeux disques garnis racing + disques lisses
- Set of racing friction plates + steel plates
- Serie conductores racing + conductos
- Racing Reibscheiben + Stahlscheiben



FCS 0608/2S

SERIE DISCHI CONDOTTORI + CONDOTTI + 4 MOLLE

- Jeux disques garnis + disques lisses + 4 ressorts Set
- of friction plates + steel plates + 4 springs Serie
- conductores + conductos + 4 muelles
- Modifizierte Reibscheiben + oberflächenbehandelte Stahlscheiben + 4 Federn.



FCS 0608/3S

SERIE DISCHI CONDOTTORI RACING + CONDOTTI + 4 MOLLE

- Jeux disques garnis racing + disques lisses + 4 ressorts
- Racing friction plates set + steel + 4 springs
- Serie conductores racing + conductos + 4 muelles
- Modifizierte Reibscheiben + oberflächenbehandelte Stahlscheiben + 4 Federn



FCS 0608 MR

SERIE MODIFICA FRIZIONE 5 DISCHI CONDOTTORI RACING + 4 DISCHI CONDOTTI + 4 MOLLE

- Jeux disques racing modifies 5 garnis + 4 disques lisses + 4 ressorts
- Modified set of 5 racing friction plates + 4 steel + 4 springs
- Serie modifica racing 5 conductores + 4 conductos + 4 muelles
- 5 modifizierte Reibscheiben + 4 oberflächenbehandelte Stahlscheiben + 4 Federn



FRIZIONI PER MOTORI MINARELLI 50 CC

MINARELLI CLUTCH KITS

MOTORI MINARELLI HF R 3 GL - RV 4



FCD 0636

SERIE DISCHI CONDOTTORI

- Jeux disques garnis
- Friction plates set
- Serie conductores
- Reibscheiben



FCS 0636 M

SERIE MODIFICA FRIZIONE

5 DISCHI CONDOTTORI

+ 4 DISCHI CONDOTTI

+ 4 MOLLE

- Jeux de disques modifies 5 garnis + 4 disques lisses en acier bleu + 4 ressorts
- Modified set of 5 friction plates + 4 steel blue plates + 4 springs
- Serie modifica 5 conductores + 4 conductos en acero blu + 4 muelles
- 5 modifizierte Reibscheiben + 4 oberflächenbehandelte Stahlscheiben + 4 Federn



FCS 0636/2

SERIE DISCHI CONDOTTORI

+ CONDOTTI

- Jeux disques garnis + disques lisses
- Set of friction plates + steel plates
- Serie conductores + conductos
- Reib-und Stahlscheiben



FCS 0636 MR

SERIE MODIFICA FRIZIONE

5 DISCHI CONDOTTORI RACING

+ 4 DISCHI CONDOTTI

+ 4 MOLLE

- Jeux disques racing modifies 5 garnis + 4 disques lisses + 4 ressorts
- Modified set of 5 racing friction plates + 4 steel + 4 springs
- Serie modifica racing 5 conductores + 4 conductos + 4 muelles
- 5 modifizierte Reibscheiben + 4 oberflächenbehandelte Stahlscheiben + 4 Federn



FRIZIONI PER LAMBRETTA LAMBRETTA CLUTCH KITS

LI 125/150/175 (58→67) - DL 125/150/200 (69→71) - TV II 175 (58→67)

SUGHERO Cork



FCD 0545 Serie dischi conduttori

- ① Jeux disques garnis
- ② Friction plates set
- ③ Serie conductores
- ④ Reibscheiben



FCS 0545/M

Serie modifica frizione 5 dischi conduttori + 4 dischi condotti acciaio

- ① Jeux 5 disques modifies garnis + 4 disques lisses en acier
- ② Modified set of 5 friction plates + 4 steel plates
- ③ Serie modifica 5 conductores + 4 conductos en acero
- ④ 5 modifizierte Reibscheiben + 4 oberflächenbehandelte Stahlscheiben



FCS 0545/2

Serie dischi 4 conduttori + 3 condotti

- ① Jeux 4 disques garnis + 3 disques lisses
- ② Set of 4 friction plates + 3 steel plates
- ③ Serie 4 conductores + 3 conductos
- ④ 4 Reibscheiben + 3 Stahlscheiben

ORGANICO Organic



FCD 0545/0 Serie dischi conduttori

- ① Jeux disques garnis Friction
- ② plates set
- ③ Serie conductores
- ④ Reibscheiben



FCS 0545/M0

Serie modifica frizione 5 dischi conduttori + 4 dischi condotti acciaio

- ① Jeux 5 disques modifies garnis + 4 disques lisses en acier
- ② Modified set of 5 friction plates + 4 steel plates
- ③ Serie modifica 5 conductores + 4 conductos en acero
- ④ 5 modifizierte Reibscheiben + 4 oberflächenbehandelte Stahlscheiben



FCS 0545/20

Serie dischi 4 conduttori + 3 condotti

- ① Jeux 4 disques garnis + 3 disques lisses
- ② Set of 4 friction plates + 3 steel plates
- ③ Serie 4 conductores + 3 conductos
- ④ 4 Reibscheiben + 3 Stahlscheiben

FRIZIONE RACING PER YAMAHA T-MAX 500 RACING CLUTCH FOR YAMAHA T-MAX 500

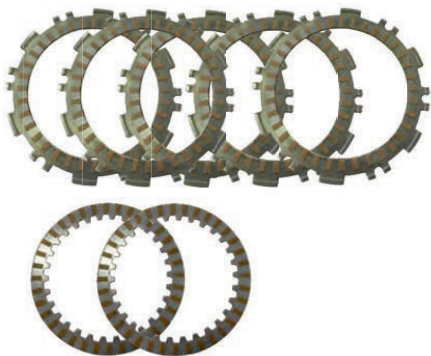

FCD0290/1

Serie dischi conduttori Racing

- Jeux disques garnis Racing Racing
- friction plates set
- Serie conductores Racing
- Racing Reibscheiben

FCS0290/3

Serie dischi conduttori Racing + condotti + molle

- Jeux disques garnis Racing + disques lisses
- Set of Racing friction plates + steel plates Serie
- conductores racing + conductos Racing
- Reibscheiben + Stahlscheiben



FCS0290/3S

Serie dischi conduttori Racing + condotti + 6 dischi molle + molle

- Jeux disques garnis Racing + disques lisses + 6 disques ressorts + ressorts
- Racing friction plates set + steel + 6 discs spring + springs
- Serie + conductores Racing + conductos + 6 discos de muelles+ muelles
- Racing Reibscheiben + oberflächenbehandelte + Stahlscheiben + 6 tellerfedern + federn

MOLLE PER FRIZIONE YAMAHA T-MAX 500

SPRINGS FOR YAMAHA T-MAX 500 CLUTCH

FSS 0217 SET 18 MOLLE

STANDARD - MEDIUM - RACING

- Series 18 ressorts
- Set 18 springs
- Series 18 muelles
- Series 18 federn



Il set è incluso nelle versioni

Springs kit enclosed in the following versions
FCS 0290/3 - FCS 0290/3S

FSS 0216 SET 6 DISCHI MOLLE

- Series 6 disques ressorts
- Set 6 disc springs Series
- 6 disco de muelles Series
- 6 tellerfedern

Il set è incluso nelle versioni

Springs kit enclosed in the following versions
FCS 0290/2S - FCS 0290/3S



FRIZIONE RACING PER YAMAHA T-MAX 530 RACING CLUTCH FOR YAMAHA T-MAX 530

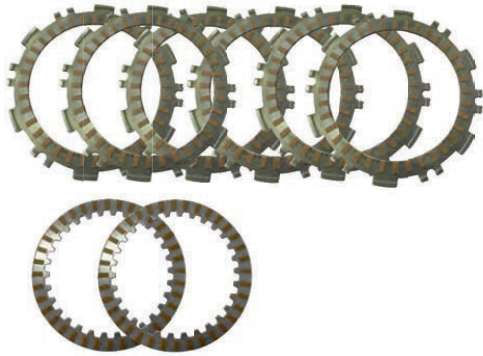

FCD1232/1

Serie dischi conduttori Racing

- Jeux disques garnis Racing Racing
- friction plates set
- Serie conductores Racing
- Racing Reibscheiben

FCS1232/3

Serie dischi conduttori Racing + condotti + molle

- Jeux disques garnis Racing + disques lisses
- Set of Racing friction plates + steel plates Serie
- conductores racing + conductos Racing
- Reibscheiben + Stahlscheiben

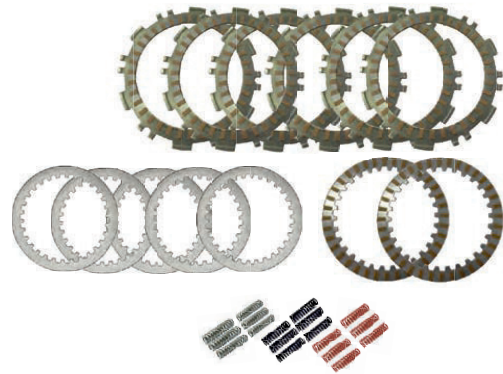

FCS1232/3S

Serie dischi conduttori Racing + condotti + 7 dischi molle + molle

- Jeux disques garnis Racing + disques lisses + 7 disques ressorts + ressorts
- Racing friction plates set + steel + 7 discs spring + springs
- Serie + conductores Racing + conductos + 7 discos de muelles+ muelles
- Racing Reibscheiben + oberflächenbehandelte + Stahlscheiben + 7 tellerfedern + federn



MOLLE PER FRIZIONE YAMAHA T-MAX 530

SPRINGS FOR YAMAHA T-MAX 530 CLUTCH

FSS 0220 SET 18 MOLLE

STANDARD - MEDIUM - RACING

- F Series 18 ressorts
- GB Set 18 springs
- E Series 18 muelles
- D Series 18 federn



Il set è incluso nelle versioni

Springs kit enclosed in the following versions
FCS1232/3 - FCS1232/3S

FSS 0219 SET 7 DISCHI MOLLE

- F Series 7 disques ressorts
- GB Set 7 disc springs Series
- E 7 disco de muelles Series
- D 7 tellerfedern



Il set è incluso nelle versioni

Springs kit enclosed in the following versions
FCS1232/3S

FERODO®

RACING

FERODO BRAKE AND CLUTCH SOLUTIONS FOR HEAVY DUTY OFF ROAD USE



Brad Freeman – Team Costa Ligure Beta Boano Racing
won the 2018 EnduroGP E1 World Championship with Ferodo!

Ferodo **brake and clutch** components are engineered to provide you
with performance and longevity even in the toughest off-road conditions.

www.ferodoracing.com

Ferodo® is a registered trademark of Federal-Mogul LLC or one or more of its subsidiaries in one or more countries.



FEDERAL-MOGUL ITALY Srl

Racing & Motorcycle Division

Corso Inghilterra, 2
12084 Mondovì (CN) ITALY

www.ferodoracing.com

